

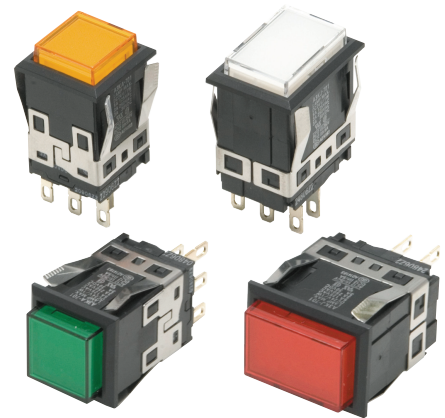

Sense of Touch and Protection Ability Improved over OMRON's Previous Models. Miniature Design Achieved with Body Length of 23 mm.

- Combines miniature design with distinct but soft sense of operation.
- Five colors (red, yellow, green, white, and blue) with LEDs.
- Improved sense of touch with built-in Basic Switch.
- Built-in Basic Switch improves protection over OMRON's previous models.
- Chip LED produces even surface brightness.
- Easy panel mounting from the front.



 Refer to *Safety Precautions for All Pushbutton Switches/Indicators* and *Safety Precautions* on page 15.

List of Models

Lighted Pushbutton Switches

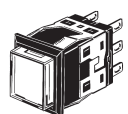
Appearance	Model
Rectangular 	A3KJ
Square 	A3KA

■ Specifications: Refer to page 10.
 ■ Accessories: Refer to pages 8 to 9.

■ Dimensions: Refer to page 12.

Model Number Structure

Model Number Legend The model numbers used to order sets of Units are illustrated below. One set comprises the Operation Unit (LED built in) and Socket Unit.
For information on combinations, refer to *Ordering Information* on page 3.

(3) (4) (5)
1 - **24E** **R** Single screen

(1) (2) Upper Lower
A3KJ - **90A2** - **24E** **R** **W** Horizontal 2-split screen

R (Red)	Upper
W (White)	Lower

(1) Shape of Operation Unit

Symbol	Shape
J	Rectangular
A	Square

(2) Switch Specifications Standard Load

Symbol	Operation	Contacts
A	Momentary	SPDT
B	Alternate	
C	Momentary	DPDT
D	Alternate	

Microload

Symbol	Operation	Contacts
E	Momentary	SPDT
F	Alternate	
G	Momentary	DPDT
H	Alternate	

- Standard Load
250 VAC, 3 A
30 VDC, 3 A
- Microload
125 VAC, 0.1 A
30 VDC, 0.1 A
- Minimum applicable load
5 VDC, 1 mA
- ▶ **Momentary operation: Self-resetting**
- ▶ **Alternate operation: Self-holding**

(3) Screen Pattern Illumination-only models

Symbol	Screen pattern
1	Single screen 

2	Horizontal 2-split screen  (rectangular models only)
---	---

The screen patterns listed below can be ordered individually. Refer to page 6 for details.

	Vertical 2-split screen  (rectangular models only)
--	---

(4) Lighting Method

Symbol	Operating voltage
05E	5 VDC
12E	12 VDC
24E	24 VDC



- Only for LED models.

(5) Color of Display

Symbol	Color
R	Red
Y	Yellow
G	Green
W	White
A	Blue
K	Red/green 2-color lighting (rectangular models only)

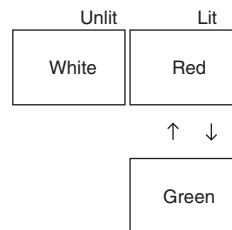
▶ **Red/green 2-color lighting:**

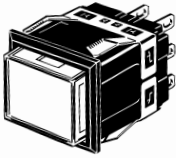
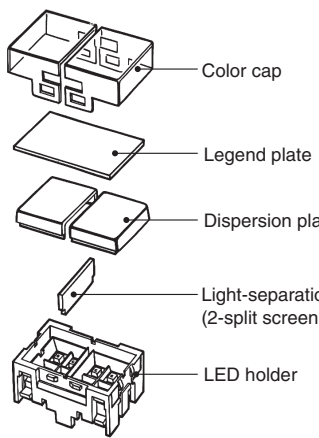
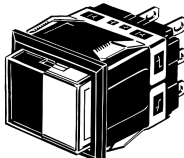

Type	Structure of Split-screen Operation Unit (Example: Vertical 2-split screen)
 Single-screen models (rectangular and square models)	 <ul style="list-style-type: none"> Color cap Legend plate Dispersion plate Light-separation plate (2-split screen only) LED holder
 Vertical 2-split screen models (See note 1.) (rectangular models only)	
 Horizontal 2-split screen models (rectangular models only)	
<p>Note: 1. Vertical 2-split screen models can be ordered only individually. Refer to page 6. 2. A legend plate and LED (with current-limiting resistor) are built into a standard Display. 3. Split-screen color configurations are given with the OMRON mark on the Switch facing down. 4. The built-in legend plate is milk-white in color.</p>	

Ordering Information

Sets..... Sets include an Operation Unit (LED built in) and a Switch.
 Not all combinations are possible. Ask your OMRON representative for details.

Standard Loads

Rectangular Models

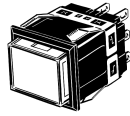

A3KJ

Standard Loads

Screen pattern	Output	Contact type Operation	Standard load (250 VAC, 3 A; 30 VDC, 3 A)		Operation Unit color symbol		
			Momentary operation (Self-resetting)	Alternate operation (Self-holding)			
Single screen	SPDT	5 VDC	A3KJ-90A1-05E ¹	A3KJ-90B1-05E ¹	Insert a color symbol in ¹ at the end of the model number. R (red), W (white) Y (yellow), A (blue) G (green), K (red/green)		
		12 VDC	A3KJ-90A1-12E ¹	A3KJ-90B1-12E ¹			
		24 VDC	A3KJ-90A1-24E ¹	A3KJ-90B1-24E ¹			
	DPDT	5 VDC	A3KJ-90C1-05E ¹	A3KJ-90D1-05E ¹			
		12 VDC	A3KJ-90C1-12E ¹	A3KJ-90D1-12E ¹			
		24 VDC	A3KJ-90C1-24E ¹	A3KJ-90D1-24E ¹			
Horizontal 2-split screen	SPDT	24 VDC	A3KJ-90A2-24E ¹ ²	A3KJ-90B2-24E ¹ ²	<table border="1" style="margin-left: auto; margin-right: auto;"> <tr><td style="text-align: center;">1</td></tr> <tr><td style="text-align: center;">2</td></tr> </table> Insert color symbols in ¹ and ² at the end of the model number. R (red), W (white) Y (yellow), A (blue) Green	1	2
	1						
2							
DPDT	24 VDC	A3KJ-90C2-24E ¹ ²	A3KJ-90D2-24E ¹ ²				

Microloads

Screen pattern	Output	Contact type Operation	Microload (125 VAC, 0.1 A; 30 VDC, 0.1 A)	Operation Unit color symbol		
			Momentary operation (Self-resetting)			
Single screen	SPDT	5 VDC	A3KJ-90E1-05E ¹	Insert a color symbol in the ¹ at the end of the model number. R (red), W (white) Y (yellow), A (blue) G (green), K (red/green)		
		12 VDC	A3KJ-90E1-12E ¹			
		24 VDC	A3KJ-90E1-24E ¹			
	DPDT	5 VDC	A3KJ-90G1-05E ¹			
		12 VDC	A3KJ-90G1-12E ¹			
		24 VDC	A3KJ-90G1-24E ¹			
Horizontal 2-split screen	SPDT	24 VDC	A3KJ-90E2-24E ¹ ²	<table border="1" style="margin-left: auto; margin-right: auto;"> <tr><td style="text-align: center;">1</td></tr> <tr><td style="text-align: center;">2</td></tr> </table> Insert color symbols in ¹ and ² at the end of the model number. R (red), W (white) Y (yellow), A (blue) G (green)	1	2
	1					
2						
DPDT	24 VDC	A3KJ-90G2-24E ¹ ²				

Note: Alternate operation models are also available. Refer to page 7 for model numbers.

Individual models: Refer to pages 5 to 7.
 (The Pushbutton and Switch can be ordered separately.)

■ Specifications: Refer to page 10. ■ Dimensions: Refer to page 12.
 ■ Accessories: Refer to pages 8 to 9.

Ordering Information

Sets Sets include an Operation Unit (LED built in) and a Socket Unit.

Square Models

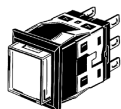

A3KA

Standard Loads

Screen pattern	Output	Contact type Operation	Standard load (250 VAC, 3 A; 30 VDC, 3 A)		Operation Unit color symbol
			Momentary operation (Self-resetting)	Alternate operation (Self-holding)	
Single screen	SPDT	5 VDC	A3KA-90A1-05E ¹	A3KA-90B1-05E ¹	Insert a color symbol in ¹ at the end of the model number. R (red), Y (yellow) G (green), W (white) A (blue)
		12 VDC	A3KA-90A1-12E ¹	A3KA-90B1-12E ¹	
		24 VDC	A3KA-90A1-24E ¹	A3KA-90B1-24E ¹	
	DPDT	5 VDC	A3KA-90C1-05E ¹	A3KA-90D1-05E ¹	
		12 VDC	A3KA-90C1-12E ¹	A3KA-90D1-12E ¹	
		24 VDC	A3KA-90C1-24E ¹	A3KA-90D1-24E ¹	

Microloads

Screen pattern	Output	Contact type Operation	Microload (125 VAC, 0.1 A; 30 VDC, 0.1 A)	Operation Unit color symbol
			Momentary operation (Self-resetting)	
Single screen	SPDT	5 VDC	A3KA-90E1-05E ¹	Insert a color symbol in ¹ at the end of the model number. R (red), Y (yellow) G (green), W (white) A (blue)
		12 VDC	A3KA-90E1-12E ¹	
		24 VDC	A3KA-90E1-24E ¹	
	DPDT	5 VDC	A3KA-90G1-05E ¹	
		12 VDC	A3KA-90G1-12E ¹	
		24 VDC	A3KA-90G1-24E ¹	

Note: Alternate operation models are also available. Refer to page 7 for model numbers.

Individual models: Refer to pages 5 to 7.
(The Pushbutton and Switch can be ordered separately.)

- Specifications: Refer to page 10.
- Dimensions: Refer to page 12.
- Accessories: Refer to pages 8 to 9.

Ordering Information

Ordering Individually Operation Units (LED built in) and Socket Units can be ordered separately. Combinations that are not available as sets can be created using individual Units. Parts can also be stored as spares for maintenance and repairs.

Ordering Specify a model number from the following page.

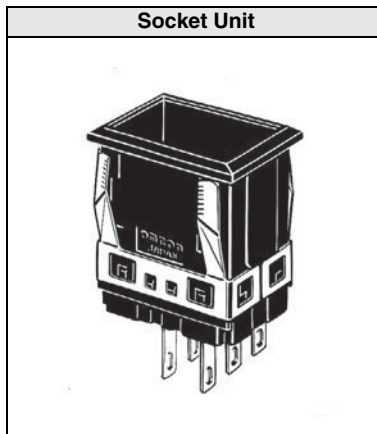
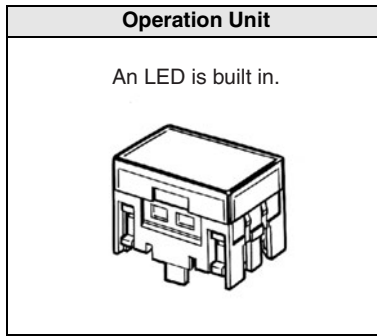

















Ordering set combinations: Refer to pages 3 to 4.

■ Specifications: Refer to page 10. ■ Dimensions: Refer to page 12.
■ Accessories: Refer to pages 8 to 9.

Ordering Information

Operation Units

LED-lighted Models (LED chip built in)

Appearance	Screen pattern	Color	White (W)	Red (R)	Green (G)	Blue (A)	Yellow (Y)	Selection precautions	
Rectangular Models (A3KJ) 	Single screen		A3KJ-51W -□□E	A3KJ-51R -□□E	A3KJ-51G -□□E	A3KJ-51A -□□E	A3KJ-51Y -□□E	<ul style="list-style-type: none"> Enter the voltage to be used in the □□ at the end of the model number. Examples of voltages used: 5V=0□5E 12V=1□2E 24V=2□4E Two-split screen models are available only for 24 V. For the color of the shaded part, select the model according to the colors given at the top of the table. 	
	Horizontal 2-split screen		A3KJ-52WW -□□E	A3KJ-52WR -□□E	A3KJ-52WG -□□E	A3KJ-52WA -□□E	A3KJ-52WY -□□E		
			A3KJ-52RW -□□E	A3KJ-52RR -□□E	A3KJ-52RG -□□E	A3KJ-52RA -□□E	A3KJ-52RY -□□E		
			A3KJ-52GW -□□E	A3KJ-52GR -□□E	A3KJ-52GG -□□E	A3KJ-52GA -□□E	A3KJ-52GY -□□E		
			A3KJ-52AW -□□E	A3KJ-52AR -□□E	A3KJ-52AG -□□E	A3KJ-52AA -□□E	A3KJ-52AY -□□E		
			A3KJ-52YW -□□E	A3KJ-52YR -□□E	A3KJ-52YG -□□E	A3KJ-52YA -□□E	A3KJ-52YY -□□E		
	Vertical 2-split screen		A3KJ-53WW -□□E	A3KJ-53WR -□□E	A3KJ-53WG -□□E	A3KJ-53WA -□□E	A3KJ-53WY -□□E		
			A3KJ-53RW -□□E	A3KJ-53RR -□□E	A3KJ-53RG -□□E	A3KJ-53RA -□□E	A3KJ-53RY -□□E		
			A3KJ-53GW -□□E	A3KJ-53GR -□□E	A3KJ-53GG -□□E	A3KJ-53GA -□□E	A3KJ-53GY -□□E		
			A3KJ-53AW -□□E	A3KJ-53AR -□□E	A3KJ-53AG -□□E	A3KJ-53AA -□□E	A3KJ-53AY -□□E		
			A3KJ-53YW -□□E	A3KJ-53YR -□□E	A3KJ-53YG -□□E	A3KJ-53YA -□□E	A3KJ-53YY -□□E		
	Two-color full illumination (red/green)	 ↓ 	A3KJ-57K -□□E						
	Square Models (A3KA) 	Single screen		A3KA-51W -□□E	A3KA-51R -□□E	A3KA-51G -□□E	A3KA-51A -□□E		A3KA-51Y -□□E

Note: 1. A legend plate and LED (with current-limiting resistor) are built into a standard Display.
 2. Split-screen color configurations are given with the OMRON mark on the Switch facing down.
 3. The built-in legend plate is milk-white in color.

Ordering set combinations: Refer to pages 3 to 4.

■ Specifications: Refer to page 10. ■ Dimensions: Refer to page 12.
 ■ Accessories: Refer to pages 8 to 9.

Ordering Information

Socket Units

Appearance				Rectangular models	Square models	Selection precautions
Contact type	Number of Switch outputs	Operation	Model	Model		
Standard load	Silver alloy contacts	1	Momentary operation	A3KJ-7010	A3KA-7010	<ul style="list-style-type: none"> Use the Socket Unit in combination with the same shape Operation Unit (rectangular or square). Example: For A3KJ-51W-24E Rectangular Operation Unit, select the A3KJ-7□□0 Socket Unit. Momentary operation is self-resetting, and alternate operation is self-holding (i.e., push-on, push-off).
			Alternate operation	A3KJ-7020	A3KA-7020	
		2	Momentary operation	A3KJ-7030	A3KA-7030	
			Alternate operation	A3KJ-7040	A3KA-7040	
Microload	Gold alloy contacts	1	Momentary operation	A3KJ-7050	A3KA-7050	
			Alternate operation	A3KJ-7060	A3KA-7060	
		2	Momentary operation	A3KJ-7070	A3KA-7070	
			Alternate operation	A3KJ-7080	A3KA-7080	





Ordering set combinations: Refer to pages 3 to 4.

■ Specifications: Refer to page 10. ■ Dimensions: Refer to page 12.
 ■ Accessories: Refer to pages 8 to 9.

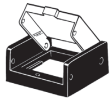

Ordering Information

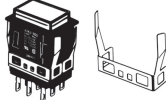
Accessories, Replacements, and Tools (Order Separately)

Accessories for Rectangular Models

Name	Appearance	Classification	Model	Application Precautions
Barrier		Short Edge Barriers (1 pair)	A3SA-4001	The purpose of a Barrier is to prevent malfunctioning and to improve design image of the mounting panel. There is one Intermediate Barrier and one pair of Edge Barriers (i.e., two Barriers). Mount Short Barriers horizontally. Mount Long Barriers vertically.
		Short Intermediate Barrier	A3SA-4002	
		Long Edge Barriers (1 pair)	A3SJ-4003	
		Long Intermediate Barrier	A3SJ-4004	
Switch Guard		—	A3SJ-5050	Cannot be used with Barriers or Seal Cover.
Seal Cover		—	A3SJ-5060	<ul style="list-style-type: none"> Cannot be used with Barriers or Switch Guard. Cap material: Vinyl chloride
Long Mounting Plate		—	A3KJ-3002	Use when vertically mounting individual (with Barrier) or multiple Switches (in standard mounting style and with Barriers). A Short Mounting Plate is attached to the Switch, so replace it with a long one.
Color cap		Transparent	A3SJ-5600	<ul style="list-style-type: none"> The color cap is normally mounted. Contact your OMRON representative for color changes or inscribing. Use a color that matches the Display color.
		White	A3SJ-5601	
		Red	A3SJ-5602	
		Green	A3SJ-5603	
		Blue	A3SJ-5604	
		Yellow	A3SJ-5605	

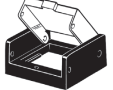
Accessories for Square Models

Name	Appearance	Classification	Model	Application Precautions
Barrier		Short Edge Barriers (1 pair)	A3SA-4001	The purpose of a Barrier is to prevent malfunctioning and to improve design image of the mounting panel.
		Short Intermediate Barrier	A3SA-4002	
Switch Guard		—	A3SA-5050	Cannot be used with Barriers or Seal Cover.
Seal Cover		—	A3SA-5060	<ul style="list-style-type: none"> Cannot be used with Barriers or Switch Guard. Cap material: Vinyl chloride
Color cap		Transparent	A3SA-5600	<ul style="list-style-type: none"> The color cap is normally mounted. Contact your OMRON representative for color changes or inscribing. Use a color that matches the Display color.
		White	A3SA-5601	
		Red	A3SA-5602	
		Green	A3SA-5603	
		Blue	A3SA-5604	
		Yellow	A3SA-5605	

■ Specifications: Refer to page 10.

■ Dimensions: Refer to page 12.

■ Accessory mounting: Refer to page 16.

Ordering Information

Tools for Rectangular Models

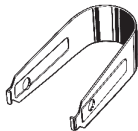
Name	Appearance	Classification	Model	Application precautions
Extractor		—	A3PJ-5080	Convenient for extracting the Operation Unit.

Replacements for Rectangular Models

Name	Appearance	Classification	Model	Application precautions
Legend plate		Milk-white LED	A3SJ-4203	All colors have a milk-white legend plate built in.

Replacements for Square Models

Name	Appearance	Classification	Model	Application precautions
Legend plate		Milk-white LED	A3SA-4203	All colors have a milk-white legend plate built in.

■ Specifications: Refer to page 10.
 ■ Accessory mounting: Refer to page 16.

■ Dimensions: Refer to page 12.

Specifications

Approved Standard Ratings

UL (File No. E41515), CSA (File No. LR45258)

Standard Load: 3 A at 250 VAC
5 A at 125 VAC
3 A at 30 VDC

Microload: 0.1 A at 125 VAC
0.1 A at 30 VDC

Note: Certification has been obtained for the Switch Unit.
For detailed information on individual products that have received certification, consult your supplier.

CCC (GB/T14048.5)

Standard Load: 3 A at 250 VAC
4 A at 30 VDC
3 A at 30 VDC

Microload: 0.1 A at 125 VAC
0.1 A at 30 VDC

Ratings

Standard Load

AC resistive load	DC resistive load
3 A at 250 VAC 5 A at 125 VAC	3 A at 30 VDC

Note: The above ratings are from testing under the following conditions:

- 1) Ambient temperature: 20 ± 2°C
- 2) Ambient humidity: 65% ± 5%RH
- 3) Operation frequency: 20 operations/min

Microload

Rating	0.1 A, 30 VDC (resistive load) 0.1 A, 125 VAC (resistive load)
Minimum applicable load	1 mA, 5 VDC

LED-lighted Models

Rectangular Models (A3KJ)

Operating voltage	Rated voltage	Rated current
5 VDC ± 5%	5 VDC	48 mA (18 mA) *
12 VDC ± 5%	12 VDC	20 mA (10 mA) *
24 VDC ± 5%	24 VDC	10 mA (5 mA) *

* Values are for blue illumination.

Square Models (A3KA)

Operating voltage	Rated voltage	Rated current
5 VDC ± 5%	5 VDC	24 mA (10 mA) *
12 VDC ± 5%	12 VDC	24 mA (10 mA) *
24 VDC ± 5%	24 VDC	12 mA (5 mA) *

* Values are for blue illumination.

Characteristics

Operating frequency	Mechanical	Momentary-action models: 120 operations/min max. *1
	Electrical	20 operations/min max.
Insulation resistance		100 MΩ min. (at 500 VDC)
Contact resistance	Standard load	50 mΩ max. (initial value)
	Microload	50 mΩ max. (initial value)
Dielectric strength	Between terminals of same polarity	1,000 VAC, 50/60 Hz for 1 minute
	Between terminals of different polarity	2,000 VAC, 50/60 Hz for 1 minute
	Between current-carrying metal part and ground	2,000 VAC, 50/60 Hz for 1 minute
	Between each terminal and non-current-carrying metal part	2,000 VAC, 50/60 Hz for 1 minute
	Between lamp terminals	1,000 VAC, 50/60 Hz for 1 minute *2
Vibration resistance	Malfunction	10 to 55 Hz, 1.5-mm double amplitude *3
Shock resistance	Destruction	500 m/s ² max.
	Malfunction	200 m/s ² max. *3
Durability	Mechanical	Momentary operation models: 2,000,000 operations min. Alternate operation models: 200,000 operations min. One operation cycle consists of set and reset operations.
	Electrical	100,000 operations min. (rated load)
Weight		Approx. 10 g
Ambient operating temperature		-10 to 50 °C (with no icing or condensation)
Ambient operating humidity		35% to 85%RH
Ambient storage temperature		-25 to 65 °C (with no icing or condensation)
Degree of protection		IP00
Electric shock protection class		Class II
PTI (proof tracking index)		175
Pollution degree		3 (IEC 60947-5-1)

*1. Alternate-action models: 60 operations/min max.
(One operation cycle consists of set and reset operations.)

*2. The figure is for when no LED is mounted.

*3. Malfunction: 1 ms max.

Operating Characteristics

Operating Characteristics	Momentary operation	Alternate operation
Operating force (OF) max.	3.92 N	4.90 N
Releasing force (RF) min.	0.49 N	0.294 N
Total travel (TT)	Approx. 3 mm	Approx. 3 mm
Pretravel (PT) max.	2.5 mm	2.5 mm
Lock travel alternate (LTA) min. *	—	0.5 mm

* Alternate operation models only.

Contact Form

Contact name	Contact form
Double-throw contacts	

Nomenclature

Model Structure

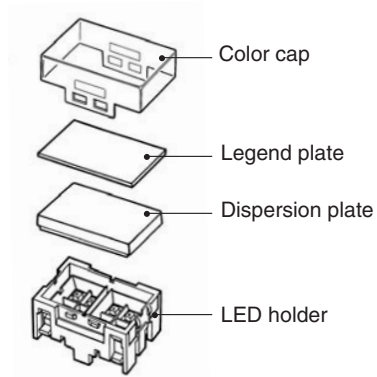

Operation Unit (LED built in)

● Operation Unit Structure

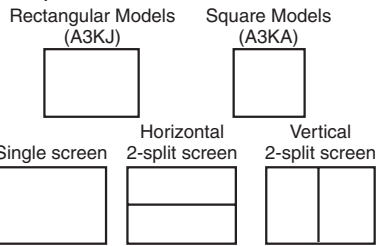

Note: Only rectangular models have split screens.

● Operation Unit color

- LED Lighting
- White, Red, Green, Yellow, Blue, Red/Green (2-color)
- Only for rectangular models (A3KJ).

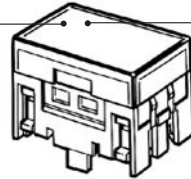

Socket Unit

● Socket Unit Specifications

- Standard load
- 3 A at 250 V
- 5 A at 125 V
- 3 A at 30 VDC
- Microload
- 0.1 A, 125 VAC
- 0.1 A, 30 VDC
- Minimum applicable load
- 1 mA at 5 VDC

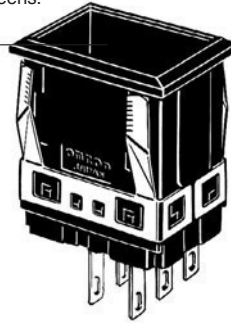

Note: The A3KJ is shown here as an example.

Dimensions The Dimension shows 2-switch outputs.

(Unit: mm)

Rectangular Models (A3KJ)

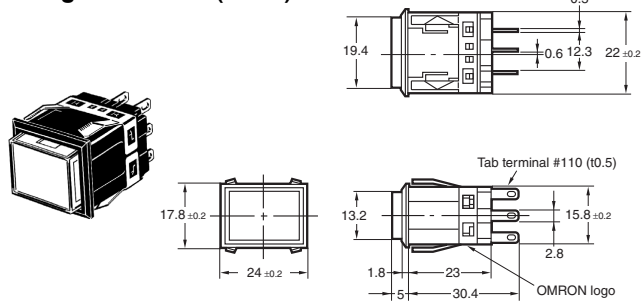

Square Models (A3KA)

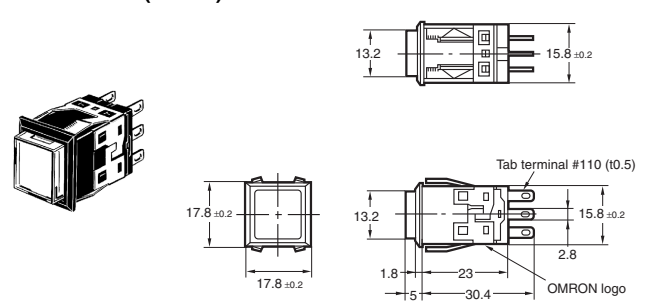

Note: Unless specified, a tolerance of ± 0.4 mm applies for all dimensions. Use a mounting panel thickness of 1 to 4 mm.

Terminal Arrangement

Bottom View (All OMRON logos face down.)

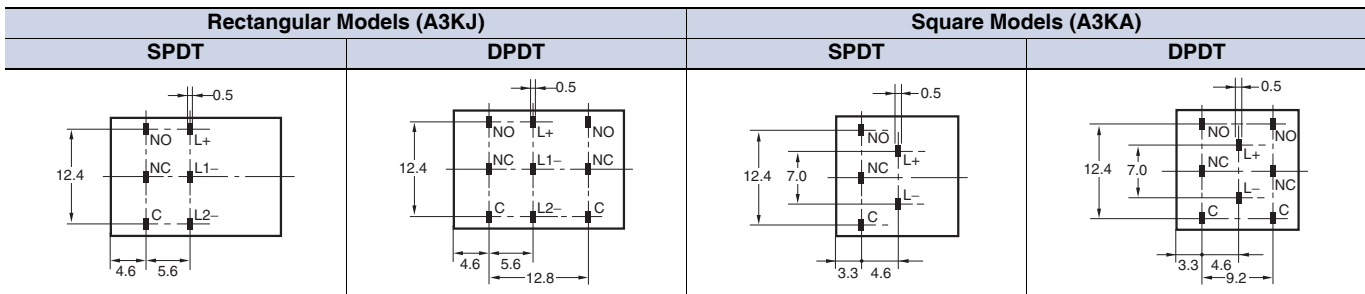

Terminal Connections

LED-lighted Models

(The terminal arrangement diagram shows a 1-switch output. Connections to terminals from the lighting block are the same for 2 outputs.)

Rated voltage		5 VDC		12 VDC		24 VDC	
Model	Screen pattern	Terminal arrangement		Terminal arrangement		Terminal arrangement	
A3KJ	Single screen						
	Horizontal 2-split screen						
	Vertical 2-split screen						
	Two-color lighting (red/green)						
A3KA	Single screen						

Dimensions

Panel Cutouts (If a Switch Guard or Seal Cover is to be used, refer to the panel cutout diagrams on the following page.)

Rectangular Models (A3KJ)

Note: Use a mounting panel thickness of 1 to 4 mm.

Classification	Mounting design	Panel cutout	Remarks
Flange mount models	Individual mounting, horizontal 		
	Multiple mounting, horizontal 		Panel cutout spacing between rows of Units:
	Individual mounting, vertical Mount to Long Mounting Plate (A3KJ-3002) before use.		
	Multiple mounting, vertical Mount to Long Mounting Plate (A3KJ-3002) before use.		
Barrier mount models	Individual mounting, horizontal 		
	Multiple mounting, horizontal 		Panel cutout spacing between rows of Units:
	Individual mounting, vertical Mount to Long Mounting Plate (A3KJ-3002) before use.		
	Multiple mounting, vertical Mount to Long Mounting Plate (A3KJ-3002) before use.		(Dotted line indicates the position of each mounting Barrier.)

Square Models (A3KA)

Note: Use a mounting panel thickness of 1 to 4 mm.

Classification	Mounting design	Panel cutout	Remarks
Flange mount models	Individual mounting 		Panel cutout spacing between rows of Units:
	Multiple mounting 		
Barrier mount models	Individual mounting 		Panel cutout spacing between rows of Units:
	Multiple mounting 		(Dotted line indicates the position of each mounting Barrier.)

Dimensions

Accessories Dimensions When Mounted

Legend Plate

Rectangular Models
A3SJ-4203, A3SJ-4204

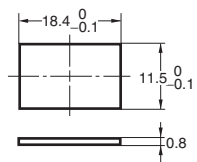

Square Models
A3SA-4203, A3SA-4204

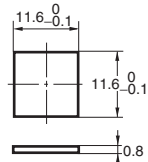

Extractor A3PJ-5080

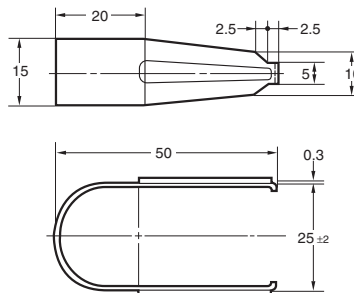

Note: The material is stainless steel.

Switch Guard Dimensions When Mounted

Rectangular Models

A3SJ-5050

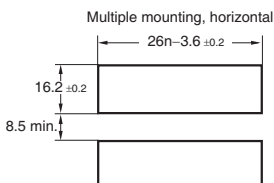
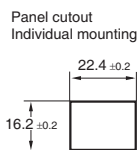
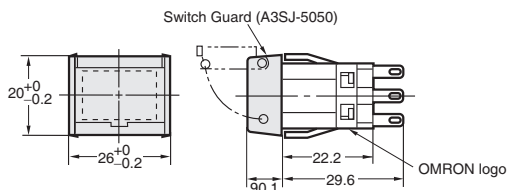
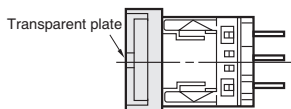

Square Models

A3SA-5050

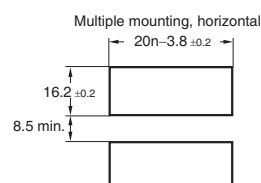
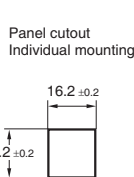
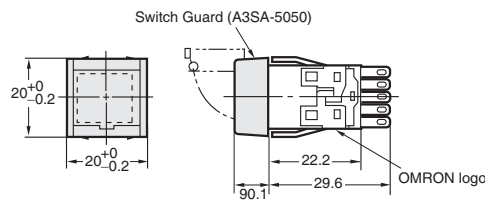
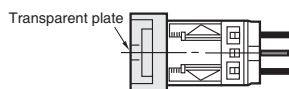

Seal Cover Dimensions When Mounted

Rectangular Models

A3SJ-5060

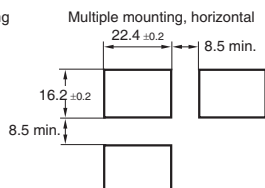
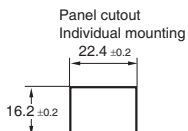
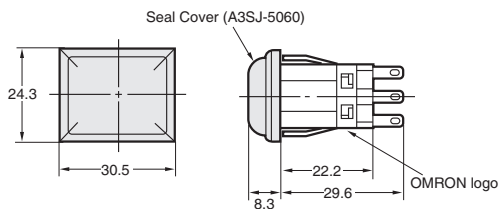
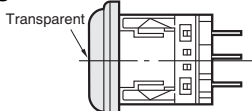

Square Models

A3SA-5060

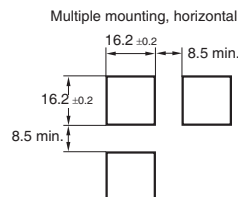
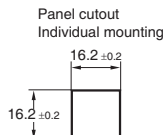
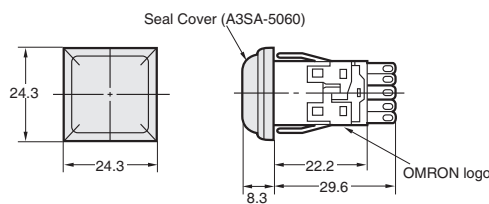
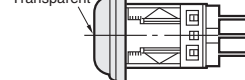

Note: 1. Use a mounting panel thickness of $t = 1$ to 3.3 mm.
2. Unless specified, a tolerance of ± 0.4 mm applies for all dimensions.

Safety Precautions

Refer to *Safety Precautions for All Pushbutton Switches/Indicators*.

Precautions for Correct Use

Mounting

- Always make sure that the power is turned OFF before mounting, removing, or wiring the Switch, or performing maintenance. Electric shock or fire may occur.

Wiring

- For wiring, use a wire size that is appropriate for the applied voltage and the supplied current.
Be sure to perform soldering according to the following conditions. Using the Switch with incomplete soldering may result in errors and heat, which may cause fire.
 - Manual soldering: Use a soldering iron with a tip temperature of 350°C maximum and complete soldering within 3 seconds.
 - Dip soldering: Solder at 350°C for 3 s or less.
Wait for one minute after soldering before exerting any external force on the solder.
- Use non-corrosive liquid rosin as the flux.
- Make sure that the insulating sheath of the wires does not come in contact with the Unit. If wiring is performed with the insulating sheath of the wires in contact with the Unit, use wire with a minimum heat resistance of 100°C.
- After wiring the Switch, make sure that there is a suitable isolation distance.

Operating Environment

- Do not use in locations that are subject to dust, oil, or metal filings, because these may penetrate the interior of the Switch and cause malfunction.

Using Microloads

- Using a standard load switch when a microload circuit is opened or closed may cause wear on the contacts. Use the switch within the operating range. (Refer to the diagram below.) Even when using microload models within the operating range shown below, if inrush current occurs when the contacts are opened or closed, it may cause the contact surface to become rough, and so decrease life expectancy. Therefore, insert a contact protection circuit where necessary. The minimum applicable load is the N-level reference value. This value indicates the malfunction reference level for the reliability level of 60% (λ_{60}) (conforming to JIS C5003).
The equation $\lambda_{60} = 0.5 \times 10^{-6}/\text{time}$ indicates that the estimated malfunction rate is less than 1/2,000,000 with a reliability level of 60%.

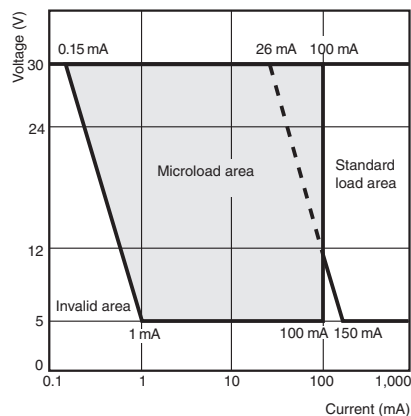

Character Film

- If the character film is to be specially prepared, use heat-resistant film with a maximum thickness of 0.2 mm.



LEDs

- A current-limiting resistor for the LED is built in, so no external resistor is required.
- Do not apply more than the rated current to the LED. Doing so may damage the LED.

Two-color Lighting

- With two-color lighting, changing the terminal connections enables two-color (red/green) full-surface colored illumination. (Only for models with the Display color symbol K.)
- To light two colors at the same time, connect an external resistors as described in the following table.

Connection Voltage	Green: L1	Red: L2
5 V	270 Ω (1/2 W)	270 Ω (1/2 W)
12 V	900 Ω (1/2 W)	900 Ω (1/2 W)
24 V	1.8 KΩ (1/2 W)	1.8 KΩ (1/2 W)

Application

Removing the Operation Unit

- Grasp the groove on the cap surface, and pull it firmly toward you to remove the Unit.
- An Extractor (A3PJ-5080) is available to conveniently remove the Display.

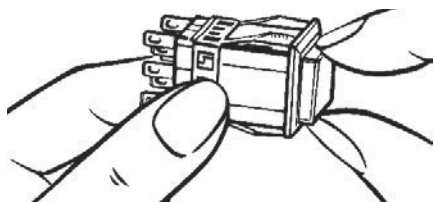

Inserting the Operation Unit into the Socket Unit

- Insert the Operation Unit in the proper direction. Insert the Operation Unit so that the "+" indication on the back (PCB) is lined up with the "O+" indication inside the Socket Unit.

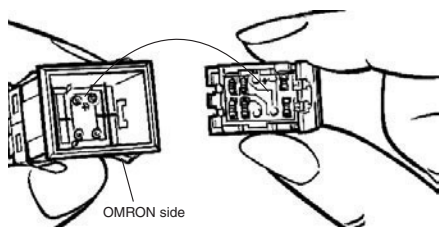

LED Rating

- The LED voltage rating is indicated on the side of the Operation Unit. Use within a range of $\pm 5\%$.

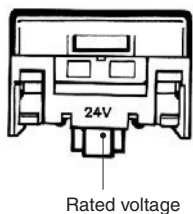

Mounting to the Switch Panel

- Mount the Socket Unit to the panel by inserting it from the front of the panel.
- Mount the Socket Unit so that the OMRON logo is at the bottom.

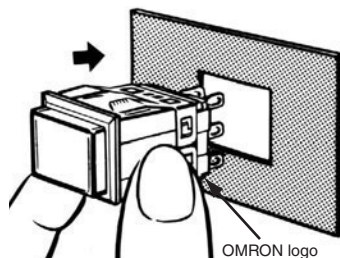

Barrier Mounting

- Place the Edge Barriers on the side of the Socket Unit, and then insert the Socket Unit into the panel.
- Insert the Intermediate Barrier between the Switches after inserting the Socket Units into the panel.

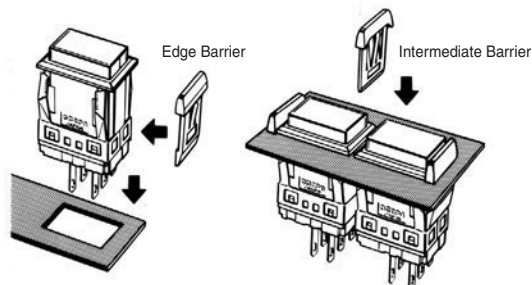

Inscribing Legend Plate Characters

Inscribing

- Inscription depth: 0.5 mm max.
- The legend plate is made of polycarbonate, so apply an alcohol-based paint coating, such as melamine, phthalate, or acrylic resin paint when marking the legend.



Assembling the Legend Plate (Plunger)

A3KA/M2KA

1. Assemble the dispersion plate to the plunger, and then assemble the legend plate on top.

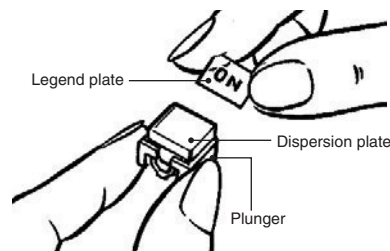

2. Assemble the color cap.

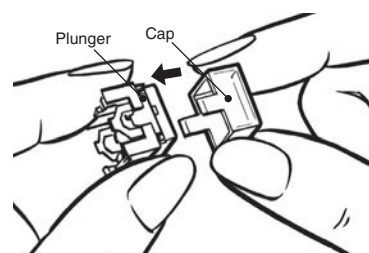

Terms and Conditions Agreement

Read and understand this catalog.

Please read and understand this catalog before purchasing the products. Please consult your OMRON representative if you have any questions or comments.

Warranties.

(a) Exclusive Warranty. Omron's exclusive warranty is that the Products will be free from defects in materials and workmanship for a period of twelve months from the date of sale by Omron (or such other period expressed in writing by Omron). Omron disclaims all other warranties, express or implied.

(b) Limitations. OMRON MAKES NO WARRANTY OR REPRESENTATION, EXPRESS OR IMPLIED, ABOUT NON-INFRINGEMENT, MERCHANTABILITY OR FITNESS FOR A PARTICULAR PURPOSE OF THE PRODUCTS. BUYER ACKNOWLEDGES THAT IT ALONE HAS DETERMINED THAT THE PRODUCTS WILL SUITABLY MEET THE REQUIREMENTS OF THEIR INTENDED USE.

Omron further disclaims all warranties and responsibility of any type for claims or expenses based on infringement by the Products or otherwise of any intellectual property right. (c) Buyer Remedy. Omron's sole obligation hereunder shall be, at Omron's election, to (i) replace (in the form originally shipped with Buyer responsible for labor charges for removal or replacement thereof) the non-complying Product, (ii) repair the non-complying Product, or (iii) repay or credit Buyer an amount equal to the purchase price of the non-complying Product; provided that in no event shall Omron be responsible for warranty, repair, indemnity or any other claims or expenses regarding the Products unless Omron's analysis confirms that the Products were properly handled, stored, installed and maintained and not subject to contamination, abuse, misuse or inappropriate modification. Return of any Products by Buyer must be approved in writing by Omron before shipment. Omron Companies shall not be liable for the suitability or unsuitability or the results from the use of Products in combination with any electrical or electronic components, circuits, system assemblies or any other materials or substances or environments. Any advice, recommendations or information given orally or in writing, are not to be construed as an amendment or addition to the above warranty.

See <http://www.omron.com/global/> or contact your Omron representative for published information.

Limitation on Liability: Etc.

OMRON COMPANIES SHALL NOT BE LIABLE FOR SPECIAL, INDIRECT, INCIDENTAL, OR CONSEQUENTIAL DAMAGES, LOSS OF PROFITS OR PRODUCTION OR COMMERCIAL LOSS IN ANY WAY CONNECTED WITH THE PRODUCTS, WHETHER SUCH CLAIM IS BASED IN CONTRACT, WARRANTY, NEGLIGENCE OR STRICT LIABILITY.

Further, in no event shall liability of Omron Companies exceed the individual price of the Product on which liability is asserted.

Suitability of Use.

Omron Companies shall not be responsible for conformity with any standards, codes or regulations which apply to the combination of the Product in the Buyer's application or use of the Product. At Buyer's request, Omron will provide applicable third party certification documents identifying ratings and limitations of use which apply to the Product. This information by itself is not sufficient for a complete determination of the suitability of the Product in combination with the end product, machine, system, or other application or use. Buyer shall be solely responsible for determining appropriateness of the particular Product with respect to Buyer's application, product or system. Buyer shall take application responsibility in all cases.

NEVER USE THE PRODUCT FOR AN APPLICATION INVOLVING SERIOUS RISK TO LIFE OR PROPERTY OR IN LARGE QUANTITIES WITHOUT ENSURING THAT THE SYSTEM AS A WHOLE HAS BEEN DESIGNED TO ADDRESS THE RISKS, AND THAT THE OMRON PRODUCT(S) IS PROPERLY RATED AND INSTALLED FOR THE INTENDED USE WITHIN THE OVERALL EQUIPMENT OR SYSTEM.

Programmable Products.

Omron Companies shall not be responsible for the user's programming of a programmable Product, or any consequence thereof.

Performance Data.

Data presented in Omron Company websites, catalogs and other materials is provided as a guide for the user in determining suitability and does not constitute a warranty. It may represent the result of Omron's test conditions, and the user must correlate it to actual application requirements. Actual performance is subject to the Omron's Warranty and Limitations of Liability.

Change in Specifications.

Product specifications and accessories may be changed at any time based on improvements and other reasons. It is our practice to change part numbers when published ratings or features are changed, or when significant construction changes are made. However, some specifications of the Product may be changed without any notice. When in doubt, special part numbers may be assigned to fix or establish key specifications for your application. Please consult with your Omron's representative at any time to confirm actual specifications of purchased Product.

Errors and Omissions.

Information presented by Omron Companies has been checked and is believed to be accurate; however, no responsibility is assumed for clerical, typographical or proofreading errors or omissions.

2022.1

In the interest of product improvement, specifications are subject to change without notice.

OMRON Corporation
Industrial Automation Company

<http://www.ia.omron.com/>

(c)Copyright OMRON Corporation 2022 All Right Reserved.