

## EtherNet/IP™

NJ/NX/NY Series, CS/CJ Series



High-speed High-capacity Industrial Ethernet  
Global Standard  
Integration of Controls and Information  
Convenience of the Universal Ethernet

# The Global Standard Network controls and information.

Data links between PLCs, between PLCs and multivendor devices, and communications between PTs and PLCs are realized with Universal Ethernet.

The global-standard network EtherNet/IP™ integrates controls and information using the latest Universal Ethernet technology and is supported by a wide range of OMRON products: PLCs, Machine Automation Controllers, HMIs, Vision sensors, Displacement Sensors, and Safety. The CJ2/NJ/NX CPU Units and NY Industrial PC Platform provide a built-in EtherNet/IP port.

**Convenience of the Universal Ethernet Right in Your Hands**

## Global Standard

- Highly open global standard for the FA industry with high future potential.
- No need for separate information and control networks.
- Improved efficiency with common Support Software operations.
- Safety systems can be monitored.

**Global Standard**

**EtherNet/IP**

# that integrates

## Ethernet Technology

- Data communications with higher capacity, **9 times** higher than previous OMRON models.
- Low cost expansion for each line.
- Reduced network construction cost.
- Easy mobile communications with FA wireless LAN.

### Integration of Controls and Information

- High-speed data links at optimal cycle, **30 times** faster than previous OMRON models
- FTP communications, data links, and Support Software can be used simultaneously with a single port.
- Memory map management is not required with the NJ/NX/NY-Series and CJ CPU Units.

## Industrial Protocol

## EtherNet/IP®

EtherNet/IP is a Global Standard for Industrial Ethernet promoted by the ODVA(ODVA,Inc.).

### Open Standard

Many companies around the world, including the main manufacturers of control devices, are marketing compatible devices.

### Independence

EtherNet/IP specifications are managed by the independent organization ODVA, which promotes the world-wide spread of open networks such as DeviceNet and CompoNet. It does not belong to a specific manufacturer.

### High Future Potential

EtherNet/IP has already been implemented in many places internationally. Its use is expected to spread further as the number of compatible devices increases.

## What Is CIP?

CIP is a Common Industrial Protocol in the OSI application layer. Routing between networks that use CIP as their base is easy. For this reason, transparent networks from sensors to host devices can be constructed easily.

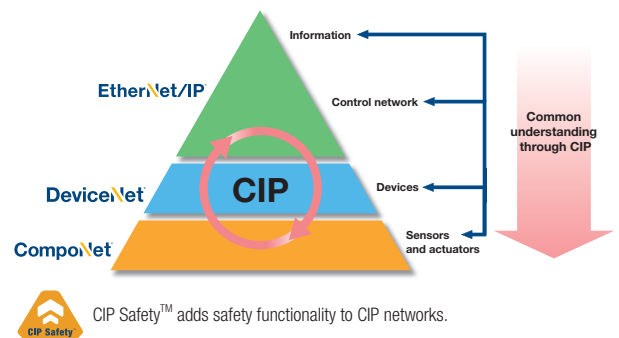

# Global Standard

FA Industry Standard Ethernet

## Global Standard

### Highly Open Global Standard for FA Industry with High Future Potential

The ODVA promotes the spread of Industrial Ethernet all over the world.

EtherNet/IP can be used to communicate with many devices from various companies around the world in addition to OMRON components (such as Temperature Controllers and Sensors). The use of EtherNet/IP will rapidly increase the development of an EtherNet/IP multivendor environment (including robots and safety devices).

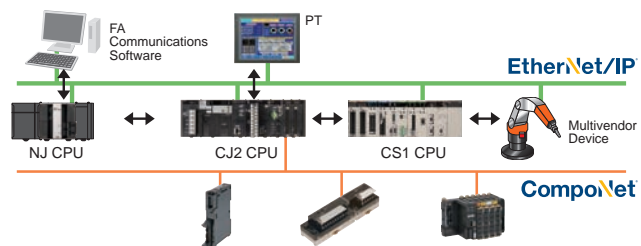

### Integrated Information and Control Network

Seamless communications on the control line and information monitoring line with EtherNet/IP

Using the global standard open protocol (CIP), an independent network system can be created with seamless data flow between the control line and the information monitoring line. OMRON FINS message communications can also be used on the same network because it is a standard LAN.

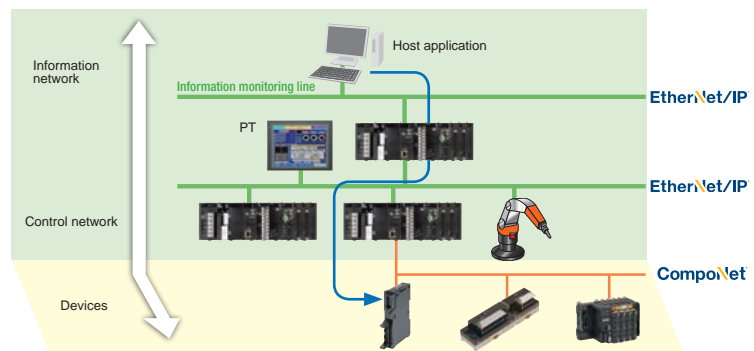

### Improved operation efficiency with common Support Software operation

Use the same operating procedures for both EtherNet/IP and DeviceNet Support Software.

The same Support Software procedures can be used from a remote location for device configuration, monitoring, and program transfer for the DeviceNet and EtherNet/IP networks.



### Monitor Safety Systems

Safety systems can be monitored through the EtherNet/IP.

The safety system can be monitored from a PLC by using a modular designed Safety Control Unit with a EtherNet/IP Coupler Unit.

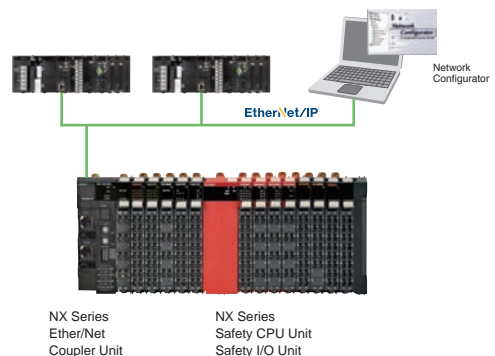

# Ethernet

Flexibility System Construction and Easy Expansion

## Convenience of the Universal Ethernet Right in Your Hands

### Higher Data Link Capacity 9 times the capacity of previous OMRON models

High-capacity communications with high-speed high-capacity bus

All types of data, from process interlocks and manufacturing recipes to production data, can be exchanged at high speed and with optimal timing. The ability to communicate is incomparably better than previous networks, such as the Controller Link and FL-net.

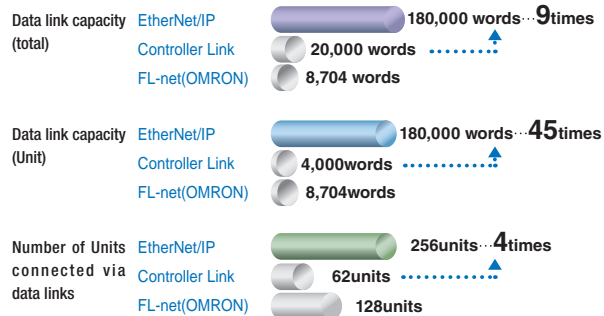

Note: Using a built-in EtherNet/IP port on C.J2H and EtherNet/IP Units.

### Low Cost Expansion for Each Line

Flexible topology with the Ethernet switch

Flexible wiring and expansion are possible with Ethernet switches. This means that there will be no total network crashes caused by communications path errors, ensuring high network performance and security.

- Joining and leaving the network is possible during communications.

Nodes can leave the network during operation, enabling easy maintenance for error detection, separation, and restoration.

- Unpredictable delays caused by data collisions are minimum.

- Problems caused by wiring errors are minimized to each line.

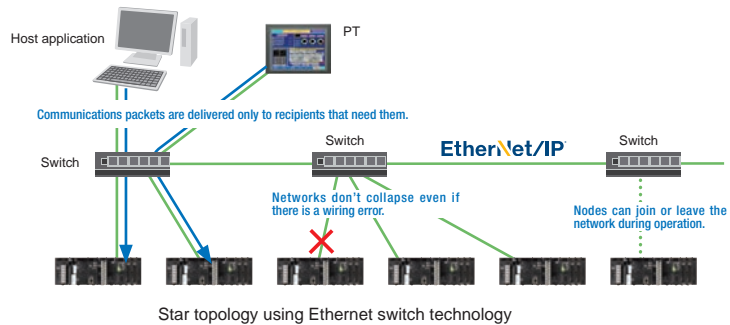

### Reduced Network Facility and Wiring Costs

Generic LAN cables can be used.

- Metal cables of category 5, 5e, or higher can be used as LAN cables.

- Generic RJ-45 connectors can be used.

### Standard wireless LAN can be used because EtherNet/IP is also Universal Ethernet.

There is no need to rewire even when layout has been changed.

- EtherNet/IP can be made wireless using the standard wireless LAN.

- High-speed Smart Roaming communications can be used for mobile units with the WE70 \*1 FA Wireless LAN. The communications range can be expanded by relaying communications between access points.

\*1. WE70 is final order entry date at the end of June 2020.

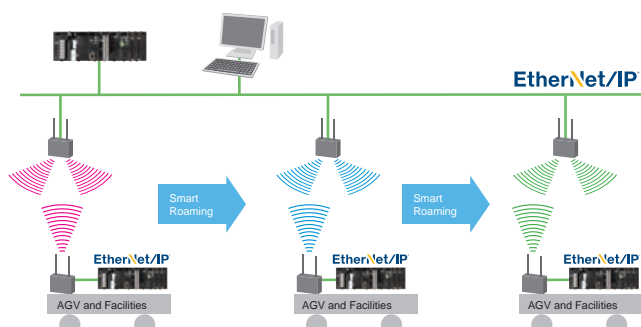

From Host to Field Level over Ethernet

## Integration of Control and Information Networks

### High-speed Data Links with Optimal Cycles for Applications

#### Flexible and high-speed cyclic communications

- Grouping can be used in data link tables to create multiple sections.
  - Data link table can be divided up to 256 groups (= connections).
  - The optimum communications cycle for the application can be set for each group.
- Cyclic synchronization can be set for each group.
  - The communications cycle can be set to between 0.5 ms and 10 s in 0.5-ms increments.
  - Data concurrency is maintained for each connection. The communications cycle does not change even if the number of nodes increases. The communications performance is 30 times better than that of the Controller Link.
  - Example: Data link refresh cycle for 25 linked Unit and 20,000 words/network is reduced from 300 ms to 10 ms.
- Facilities can be easily expanded.
  - When expanding facilities, all you need to do is make additions to the tables. Expansion is possible with little time and low cost.
  - Note: Using a built-in EtherNet/IP port on CJ2H and EtherNet/IP Units.

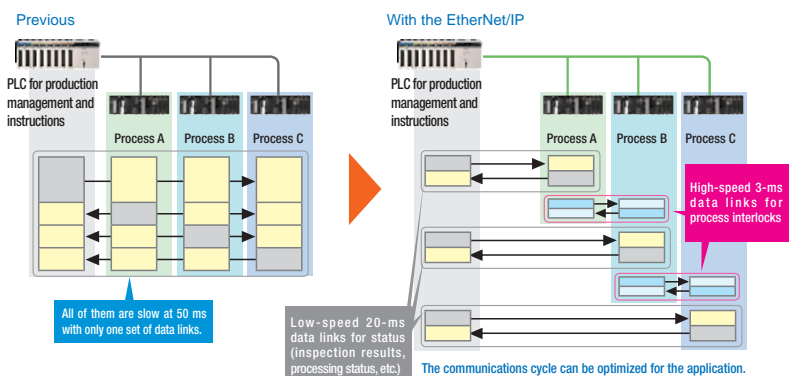

### FTP, Data Links, and Support Software Can Be Used Simultaneously with One Port

With the multipurpose EtherNet/IP port, an Ethernet Unit is not required for expansion.

Using the multipurpose EtherNet/IP port built into a CJ/NJ/NX/NY Unit, a single port can be used for data link communications between PLCs, messages between PLCs, and Universal Ethernet communications, such as FTP transfers while connecting Support Software. An EtherNet/IP Unit can be added to any CS/CJ-series PLC to achieve the same functions.

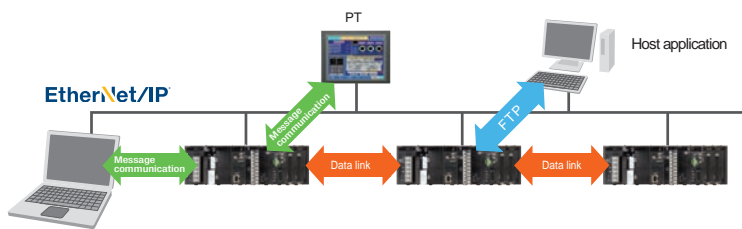

Using a CJ/NJ/NX/NY CPU Unit...

### Memory Map Management Becomes Unnecessary.

#### Freed from memory map by tags

The transmission/reception area can be specified with normal names called tag names instead of addresses for communication on data links between devices or when communication with the host application. The efficiency of design, startup, maintenance, and upgrading are improved.

- PT and host applications can be developed in parallel.
  - Network symbols defined in CJ/NJ/NX/NY Units can be used as tags when designing the PT screen.
  - Design is easy: Just decide on the tag names for the information and control departments.
  - Changes to allocated addresses is not needed later in development.
- Easier facility upgrading and maintenance
  - Even if physical addresses change in the PLC, there is no need to make any changes in the data link settings, in the PT, or in the host application.

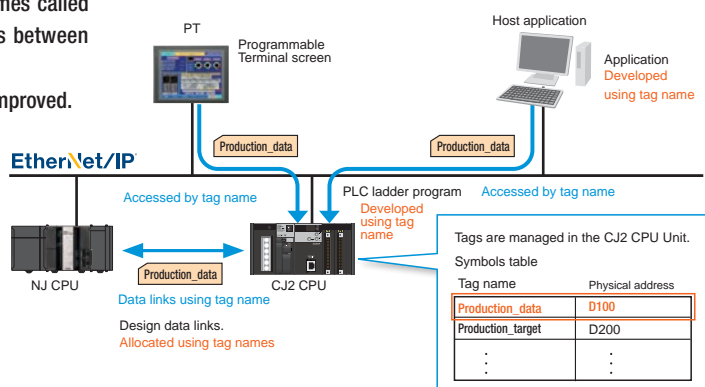

# EtherNet/IP Communications Specifications (CS/CJ/NJ/NX/NY Series)

Item	Model	Machine Automation Controller					Industrial PC Platform IPC Machine Controller	Programmable Controller		
		Built-in EtherNet/IP port on NX701-□□□□	Built-in EtherNet/IP port on NX502-□□□□ NX502 EtherNet/IP Unit NX-EIP201	Built-in EtherNet/IP port on NX102-□□□□	Built-in EtherNet/IP port on NJ501-□□□□ or NJ301-□□□□ or NJ101-□□□□	Built-in EtherNet/IP port on NX1P2	Built-in EtherNet/IP port on NY5□□-1	Built-in EtherNet/IP port on CJ2H-CPU□□-EIP CS/CJ EtherNet/IP Unit CJ1W-EIP21(S)/CS1W-EIP21(S)	Built in EtherNet/IP Port on CJ2M-CPU3□	
Number of port		2	2	2	1	1	1	1	1	
Transfer Specifications	Media access Method	CSMA/CD								
	Modulation method	Baseband								
	Transmission paths	Star form								
	Baud rate	1G bit/s (1000BASE-T)			100M bit/s (100BASE-TX)		1G bit/s (1000BASE-T)	100M bit/s (100BASE-TX)		
	Transmission media	Shielded twisted-pair (STP) cable Category: 5, 5e or higher								
	Transmission distance	100 m (distance between hub and node)								
CIP service	Tag data links (Cyclic communications)	Number of connections	256 / port total 512	NX502-□□□□: 64 / port total 128 NX-EIP201: 256 / port total 512	32 / port total 64	32	32	128	256	32
		Packet interval (refresh cycle)	0.5 to 10,000 ms (in 0.5-ms units)	1 to 10,000 ms (in 1-ms units)	1 to 10,000 ms (in 1-ms units)	1 to 10,000 ms *1 (in 1-ms units)	2 to 10,000 ms (in 1-ms units)	1 to 10,000 ms (in 1-ms units)	0.5 to 10,000 ms (in 0.5-ms units)	1 to 10,000 ms (in 0.5-ms units)
		Maximum allowed communications bandwidth per Unit	40,000 pps *2 *3	NX502-□□□□: 20,000 pps *2 *4 NX-EIP201: 40,000 pps *2 *5	12,000 pps *2 *4	3,000 pps *1 *2		20,000 pps *2	6,000 to 12,000 pps *2 *6	3,000pps *2
		Maximum link data size per Node (total size of all tags)	369,664 bytes (Total in 2 ports 739,328 byte)	92,416 bytes (Total in 2 ports 184,832 byte)	19,200 bytes (Total in 2 ports 38,400 byte)	19,200 bytes (9,600 words)		184,832 bytes (92,416 words)	369,664 bytes (184,832 words)	1,280 bytes (640 words)
		Maximum data size per connection	1,444 bytes (722 words) *7	1,444 bytes	600 bytes	600 bytes (300 words) *7		1,444 bytes (722 words) *7	1,444 bytes (722 words) or 504 bytes (252 words) *7	1,280 bytes (640 words) *6 *8
		Changing tag data link parameters during operation	Supported. *9							
		Multicast packet filter function *10	Supported.							
	Explicit Messaging	Class 3 (connected)	Supported.							
		UCMM (unconnected)	Supported.							
		CIP routing	Supported. CIP routing is supported for the following remote Units: NX701-□□□□, NX502-□□□□, NX102-□□□□, NX1P2-□□□□ NJ501-□□□□, NJ301-□□□□, NJ101-□□□□, CS1W-EIP21, CJ1W-EIP21, CJ2H-CPU□□-EIP, and CJ2M-CPU3□. Using a combination of any Units above, communication can be extended up to a maximum of 8 levels.							

- \*1. Use NJ-series CPU Unit with version 1.03 or later and Sysmac Studio with version 1.04 or later.  
When using the CPU Unit version 1.02 or earlier, the Packet interval is 10 to 10,000 ms in 1.0-ms increments and the Maximum allowed communications bandwidth per Unit is 1,000 pps.
- \*2. In this case, pps means "packets per second" and indicates the number of packets that can be processed in one second. Including heartbeat.
- \*3. If the two built-in EtherNet/IP ports are used simultaneously, the maximum communications data size for two ports in total will be reached.
- \*4. The allowable bandwidth varies depending on the RPI of the connection in use, the primary task period, and the number of ports simultaneously used for EtherNet/IP communications.
- \*5. When the Unit is performing tag data link communications where the allowable communications bandwidth per Unit is close to or greater than 30,000 pps, the following functions may not be used properly. In that case, use the built-in EtherNet/IP port on the CPU Unit or an EtherNet/IP port of a different NX-series EtherNet/IP Unit.
  - Connecting the Sysmac Studio online from the EtherNet/IP port of the NX-series EtherNet/IP Unit
  - Connecting the Network Configurator online from the EtherNet/IP port of the NX-series EtherNet/IP Unit
  - Connecting the NA-series Programmable Terminal online from the EtherNet/IP port of the NX-series EtherNet/IP Unit
  - Port forward via the NX-series EtherNet/IP Unit
  - CIP message communications
  - SNMP function
 These functions of the NX-series EtherNet/IP Unit can be used via X Bus from the built-in EtherNet/IP port on the CPU Unit or an EtherNet/IP port of a different NX-series EtherNet/IP Unit.
- \*6. When using CJ1W-EIP21S/CS1W-EIP21S or CJ1W-EIP21/CS1W-EIP21 with version 3.0 or later.  
When using CJ1W-EIP21/CS1W-EIP21 with version 2.1 or earlier, the allowed communications bandwidth per Unit is 6,000 pps.
- \*7. To use 505 to 1,444 bytes as the data size, the system must support the Large Forward Open standard (an optional CIP specification).  
NJ/NX/NY-series, CS/CJ-series Units support this standard, but other companies' devices may not support it.
- \*8. Unit version 2.0 of built-in EtherNet/IP section: 20 words.
- \*9. If parameters are changed, the target built-in EtherNet/IP port or EtherNet/IP Unit will restart. When other nodes communicating with the target node, the affected data will temporarily timeout and automatically recover later.
- \*10. Since the EtherNet/IP Unit is equipped with an IGMP client, unnecessary multicast packets can be filtered by using a switching hub that supports IGMP snooping.

## Ordering Information

### ■ NX-series NX701 CPU Units

Product name	Specifications			Current (Power) consumption	Model
	Program capacity	Memory capacity for variables	Number of motion axes		
NX701 CPU Units	80 MB	4 MB: Retained during power interruption 256 MB: Not retained during power interruption	256	40 W (including SD Memory Card and End Cover)	<b>NX701-1700</b>
					128
NX701 Database Connection CPU Units		4 MB: Retained during power interruption 256 MB: Not retained during power interruption (including Memory for CJ-series Units)	256		<b>NX701-1720</b>
			128		<b>NX701-1620</b>

### ■ NX-series NX502 CPU Units

Product name	Specifications			Model	
	Program capacity	Memory capacity for variables	Maximum number of used real axes		
NX502 CPU Unit	80 MB	4 MB (Retain attributes) / 256 MB (No Retain attributes)	64 axes	64 axes	<b>NX502-1500</b>
			32 axes	32 axes	<b>NX502-1400</b>
			16 axes	16 axes	<b>NX502-1300</b>

- Note1.** One NX-END02 End Cover is provided with the NX502-□□□□.  
**2.** The battery is not mounted when the product is shipped.

### ■ NX-series NX502 EtherNet/IP Unit

Product name	Specifications			Model
	Communications	Units per CPU Unit	Power consumption	
EtherNet/IP Unit	Tag data links, Message Communications	4 max.	8.1 W max.	<b>NX-EIP201</b>

### ■ NX-series NX102 CPU Units

Product name	Specifications				Model	
	Program capacity	Memory capacity for variables	Maximum number of used real axes			
NX102 CPU Unit	5 MB	1.5 MB (Retained during power interruption)/ 32 MB (Not retained during power interruption)	12	8	4	<b>NX102-1200</b>
			8	4	4	<b>NX102-1100</b>
			6	2	4	<b>NX102-1000</b>
			4	0	4	<b>NX102-9000</b>
NX102 Database Connection CPU Unit			12	8	4	<b>NX102-1220</b>
			8	4	4	<b>NX102-1120</b>
			6	2	4	<b>NX102-1020</b>
			4	0	4	<b>NX102-9020</b>

- Note1.** One NX-END02 End Cover is provided with the NX102 CPU Unit.  
**2.** The battery is not mounted when the product is shipped.



## NJ-series CPU Units

Product name	Specifications								Current consumption (A)		Model
	I/O capacity / maximum number of configuration Units (Expansion Racks)	Program capacity	Memory capacity for variables	Number of motion axes	Database Connection function	SECS/GEM Communication function	Number of controlled robots	Numerical Control (NC) function	5 VDC	24 VDC	
NJ501 CPU Units	2,560 points / 40 Units (3 Expansion Racks)	20MB	2 MB: Retained during power interruption 4 MB: Not retained during power interruption	64	No	No	—	No	1.90	—	NJ501-1500
				32							NJ501-1400
				16							NJ501-1300
NJ301 CPU Units		5MB	0.5 MB: Retained during power interruption	8							NJ301-1200
				4							NJ301-1100
NJ101 CPU Units		3MB	2 MB: Not retained during power interruption	2							NJ101-1000
				0	NJ101-9000						
NJ-series Database Connection CPU Units		20MB	2 MB: Retained during power interruption 4 MB: Not retained during power interruption	64	Yes	No	—	No	1.90	—	NJ501-1520
				32							NJ501-1420
				16							NJ501-1320
NJ-series SECS/GEM CPU Unit		3MB	0.5 MB: Retained during power interruption 2 MB: Not retained during power interruption	2	No	Yes	—	No	1.90	—	NJ101-1020
				0							NJ101-9020
NJ-series NJ Robotics CPU Units		20MB	2 MB: Retained during power interruption 4 MB: Not retained during power interruption	16	No	No	8 max.*1	No	1.90	—	NJ501-1340
				64							NJ501-4500
	32			NJ501-4400							
	16			NJ501-4300							
Robot Integrated CPU Units	20MB	2 MB: Retained during power interruption 4 MB: Not retained during power interruption	16	Yes	No	1	No	1.90	—	NJ501-4310	
			64							NJ501-4320	
			32							NJ501-R500	
NJ-series NC Integrated Controller	20MB	2 MB: Retained during power interruption 4 MB: Not retained during power interruption	16	No	No	8 max.*1	No	1.90	—	NJ501-R400	
			32							NJ501-R300	
			16 *2			—	Yes *3			NJ501-5300	

\*1. The number of controlled robots varies according to the number of axes used for the system.

\*2. The number of controlled axes of the MC Control Function Module is included.

\*3. One CNC Operator License (SYSMAC-RTNC0001L) is attached with the CPU Unit.

## NX-series NX1P2 CPU Units

Product name	Specifications						Model				
	Program capacity	Memory capacity for variables	Maximum number of used real axes			Total of built-in Inputs					
				Number of motion axes	Single-axis position control axes	Inputs		Outputs			
NX1P2 CPU Units	1.5 MB	32 kB: Retained during power interruption 2 MB: Not retained during power interruption	8	4	4	40	24	16, NPN transistor	NX1P2-1140DT		
								16, PNP transistor *	NX1P2-1140DT1		
			6	2	4			16, NPN transistor	NX1P2-1040DT		
								16, PNP transistor *	NX1P2-1040DT1		
			4	0	4			24	14	10, NPN transistor	NX1P2-9024DT
								10, PNP transistor *	NX1P2-9024DT1		

**Note:** NX1P2 includes 1 End Cover (NX-END02).

\* With load short-circuit protection.

## Industrial PC Platform NY-series IPC Machine Controller

The industrial PC Platform has extended configuration possibilities to meet your requirements, below an overview of the most used and recommended models. Selecting one of the models below will bring the benefit of faster delivery times.

In case your preferred model is not listed below, please contact your Omron representative to discuss the possibilities.

Product name		Specifications					Model			
		OS	CPU type	Number of motion axes	RAM memory (non-ECC type)	Storage size		Interface option		
Industrial Box PC		Windows 10 IoT Enterprise 2019 LTSC 64 bit	Intel® Core™ i5-7440EQ	64	32 GB	128GB SSD MLC	RS-232C	NY512-1500-1XX445K1X		
					8 GB	256 GB CFast MLC	No	NY512-1500-0XX44370X		
				32	32 GB	128 GB SSD MLC	RS-232C	NY512-1400-1XX445K1X		
					8 GB	256 GB CFast MLC	No	NY512-1400-0XX44370X		
16	32 GB			128 GB SSD MLC	RS-232C	NY512-1300-1XX445K1X				
	8 GB			256 GB CFast MLC	No	NY512-1300-0XX44370X				
Industrial Panel PC	Standard models					64	32 GB	256 GB CFast MLC	No	NY532-1500-011445700
							8 GB	128 GB CFast MLC		NY532-1500-011443600
		32	32 GB			256 GB CFast MLC	NY532-1400-011445700			
			8 GB			128 GB CFast MLC	NY532-1400-011443600			
		16	32 GB			256 GB CFast MLC	NY532-1300-011445700			
			8 GB			128 GB CFast MLC	NY532-1300-011443600			

## CJ2H CPU Units (with Built-in EtherNet/IP)

Product name	I/O capacity/No. of Configuration Units (maximum No. of Expansion Racks)	Program capacity	Data memory capacity	LD instruction execution time	Current consumption (A)		Model
					5V	24V	
CJ2H CPU Units (with Built-in EtherNet/IP)	2560 points/40 Units (3 Expansion Racks max.)	400 Ksteps	832 K words (DM: 32 K words, EM: 32 K words x 25 banks)	0.016 μs	0.82 *	—	CJ2H-CPU68-EIP
		250 Ksteps	512 K words (DM: 32 K words, EM: 32 K words x 15 banks)				CJ2H-CPU67-EIP
		150 Ksteps	352 K words (DM: 32 K words, EM: 32 K words x 10 banks)				CJ2H-CPU66-EIP
		100 Ksteps	160 K words (DM: 32 K words, EM: 32 K words x 4 banks)				CJ2H-CPU65-EIP
		50 Ksteps	160 K words (DM: 32 K words, EM: 32 K words x 4 banks)				CJ2H-CPU64-EIP

\* Add 0.15 A per Adapter when using NT-AL001 RS-232C/RS-422A Adapters. Add 0.04 A per Adapter when using CJ1W-CIF11 RS-422A Adapters. Add 0.20A/Unit when using NV3W-M□20L(-V1) Programmable Terminals. Refer to the CJ2 CPU Unit Catalog (Cat. No. P059) for details.

## CJ2M CPU Units (with Built-in EtherNet/IP)

Product name	Specifications						Current consumption (A)		Model
	I/O capacity/Mountable Units (Expansion Racks)	Program capacity	Data memory capacity	LD instruction execution time	EtherNet/IP function	Option board slot	5 V	24 V	
CJ2M (with Built-in EtherNet/IP) CPU Units	2,560 points/40 Units (3 Expansion Racks max.)	60K steps	160K words (DM: 32K words, EM: 32K words x 4 banks)	0.04 μs	YES	YES	0.7*	—	CJ2M-CPU35
		30K steps							CJ2M-CPU34
		20K steps	64K words (DM: 32K words, EM: 32K words x1 bank)						CJ2M-CPU33
		10K steps							CJ2M-CPU32
		5K steps							CJ2M-CPU31

\* Add 0.005A, 0.030A, and 0.075A when using Serial Communications Option Boards (CP1W-CIF01/11/12), respectively. Add 0.15A/Unit when using NT-AL001 RS-232C/RS-422A Adapters. Add 0.04A/Unit when using CJ1W-CIF11 RS-422A Adapters. Add 0.20A/Unit when using NV3W-M□20L(-V1) Programmable Terminals. Refer to the CJ2 CPU Unit Catalog (Cat. No. P059) for details.

## CS/CJ EtherNet/IP Units

Unit type	Product name	Specifications				Current consumption (A)			Model
		Communications cable	Communications type	Max. Units mountable per CPU Unit	No. of unit numbers allocated	5V	24V	26V	
CJ CPU Bus Unit	EtherNet/IP Unit	Shielded twisted-pair cable (STP), category 5, 5e or higher	Tag data links and message communications	8 *1	1	/	/	/	CJ1W-EIP21 *2*3
			Tag data links, message communications and socket service						CJ1W-EIP21S *4
CS CPU Bus Unit	EtherNet/IP Unit		Tag data links and message communications	8	1				CJ1W-EIP21 *5
			Tag data links, message communications and socket service						CS1W-EIP21S *6

\*1. Up to four EtherNet/IP Units can be connected to a NJ CPU Unit. Up to seven EtherNet/IP Units can be connected to a CJ2H-CPU6 □-EIP. Up to two EtherNet/IP Units can be connected to a CJ2M CPU Unit.

\*2. The EtherNet/IP Units can be used in CJ-series (CJ1 and CJ2), CP1H, NSJ-series and NJ-series PLCs.

EtherNet/IP Unit with unit version 2.1 or later is required to connect C1JW-EIP21 to NJ-series CPU Unit. Use NJ-series CPU Unit with version 1.01 or later and Sysmac Studio with version 1.02 or later.

\*3. You cannot use the following functions if you connect to the NJ-series CPU Unit through an EtherNet/IP Unit.

- Going online with a CPU Unit from the Sysmac Studio. (However, you can go online from the Network Configurator.)
- Troubleshooting from an NS-series PT.

\*4. For the CJ1W-EIP21S, the following CPU Units are supported. CJ2H-CPU□□, CJ2H-CPU□□-EIP, CJ2M-CPU□□ and CJ1G-CPU4□P

\*5. The EtherNet/IP Units can be used in CS-series PLCs.

\*6. For the CS1W-EIP21S, the following CPU Units are supported. CS1G-CPU□□□□, CS1H-CPU□□□□, CS1D-CPU□□□□/HA/H, CS1D-CPU□□□□/SA/S and CS1D-CPU□□□□P

## ■ NX-series EtherNet/IP Coupler Unit

Product name	Current consumption	Maximum I/O power supply current	Model
EtherNet/IP Coupler Unit	1.60 W or lower	10 A	NX-EIC202

**Note:** For details, refer to the NX-EIC202 datasheet, visit our Web site ([www.ia.omron.com/](http://www.ia.omron.com/)).

## ■ Programmable Multi-Axis Controller

Product name	Memory capacity	Port	Max. no. of controlled axes at EtherCAT port	Model
CK3M CPU Unit *1	RAM: 1 GB Built-In flash memory: 1 GB	EtherNet/IP: 1 EtherCAT: None	—	CK3M-CPU101
		EtherNet/IP: 1 EtherCAT:1 (DC sync)	4	CK3M-CPU111
		EtherNet/IP: 1 port EtherCAT: 1 (DC sync)	8	CK3M-CPU121
CK3E	Main memory: 1 GB Flash memory: 1 GB	EtherNet/IP: 1 EtherCAT: 1	8	CK3E-1210
			16	CK3E-1310
			32	CK3E-1410

**Note:** For details, refer to the CK3M CPU Unit datasheet or CK3E datasheet, visit our Web site ([www.ia.omron.com/](http://www.ia.omron.com/)).

\*1. One CK3W-TER11 End Cover is provided with the CK3M-CPU1□1 CPU Unit.

## ■ IP67 Remote Terminal NXR Series IO-Link Master Unit for EtherNet/IP™

Product name	Number of IO-Link ports	Degree of protection	Port connection	Model
IO-Link Master Unit for EtherNet/IP	8	IP67	M12 connector (A-cording, female)	NXR-ILM08C-EIT

**Note:** For details, refer to the NXR-Series Catalog (Cat. No. R202).

## ■ Programmable Terminals

Product name	Specifications	Model
NA Series	15.4 inch wide screen TFT, 1280 x 800 dots, Frame color: Black *1	NA5-15W101B-V1
	12.1 inch wide screen TFT, 1280 x 800 dots, Frame color: Black *1	NA5-12W101B-V1
	9 inch wide screen TFT, 800 x 480 dots, Frame color: Black *1	NA5-9W001B-V1
	7 inch wide screen TFT, 800 x 480 dots, Frame color: Black *1	NA5-7W001B-V1
NS Series *3	15-inch TFT, 1,024 x 768 dots, Frame color: Silver	NS15-TX01S-V2
	15-inch TFT, 1,024 x 768 dots, Frame color: Black *2	NS15-TX01B-V2
	12.1-inch TFT, 800 x 600 dots, Frame color: Black *2	NS12-TS01B-V2
	10.4-inch TFT, 640 x 480 dots, Frame color: Black *2	NS10-TV01B-V2
	8.4-inch TFT, 640 x 480 dots, Frame color: Black *2	NS8-TV01B-V2
	5.7-inch High-luminance TFT, 320 x 240 dots, Frame color: Black *2	NS5-TQ11B-V2
	5.7-inch TFT, 320 x 240 dots, Frame color: Black *2	NS5-SQ11B-V2

\*1. The PTs are also available with silver colored frames. For details, refer to the NA Series Catalog (Cat. No. V457).

\*2. The PTs are also available with ivory colored frames. For details, refer to the NS Series Catalog (Cat. No. V405).

\*3. Product no longer available to order.

## ■ FA Wireless LAN Units (Final order entry date : The end of June, 2020)

Product name	Applicable area	Type	Model
FA Wireless LAN Units	Japan	Access point (master)	WE70-AP
		Client (slave)	WE70-CL

**Note:**1. Includes Pencil Antenna, Mounting Magnet, and Mounting Screws.

2. Always use a model applicable for your area.

There are applicable products for other areas, such as Europe, USA, Canada, and China. For details, refer to the FA Wireless LAN Unit Datasheet (Cat. No. N154).

## ■ Vision Sensor

Product name	Specifications	Model
Vision System FH Series	All controllers	FH-□□□□(-□□)
Vision System FZ5 Series	High-speed Controllers	FZ5-120□(-10)
	Standard Controllers	FZ5-80□(-10)
Smart Camera FH-series	All cameras	FHV7H-□□□□□□-□(□□-□□)
Smart Camera F430-F Series	All cameras	F430-F□□□□□□□□-□□□□
Smart Camera FQ2 Series	All Sensors	FQ2-S□
Optical Character Recognition Sensor FQ2-CH Series	All Sensors	FQ2-CH□

**Note:** For details, refer to the Vision System FH Series Catalog (Cat. No. Q197), Vision System FZ5 Series Catalog (Cat. No. Q203), Smart Camera FHV7 Series Catalog (Cat. No. Q265), Smart Camera F430-F/F420-F Series Catalog (Cat.No.Q272), Smart Camera FQ2 Series Catalog (Cat. No. Q193).

## ■ Displacement Sensor

Product name	Type	Model
Displacement Sensor ZW-8000/7000/5000 Series	All Controllers	ZW-8000T
		ZW-7000T
		ZW-5000T

\* For details, refer to the Confocal Fiber Displacement Sensor Catalog (Cat. No. Q250), the Confocal Fiber Displacement Sensor Data Sheet (Cat. No. Q261).

## ■ NX series Safety Communication Controller (supporting CIP Safety)

Product name	Supported communications protocol	Number of communications connectors	Network variables	Model
NX series Communication Control Unit	EtherNet/IP *1	3	2 *2	<b>NX-CSG320</b>

**Note.** For details, refer to the Safety Network Controller NX Series Catalog (Cat. No. F104).

\*1. Routing of the CIP Safety protocol is supported.

\*2. PORT1 is an independent port. PORT2A and PORT2B are the ports with a built-in Ethernet switch.

## ■ GI-S series Safety I/O Terminals (supporting CIP Safety)

Product name	I/O capacity			Model
	Safety inputs	Test outputs	Safety outputs (for PNP)	
Safety I/O Terminals GI-S series	12 inputs	12 outputs	4 outputs	<b>GI-SMD1624</b>
	12 inputs	12 outputs	---	<b>GI-SID1224</b>

**Note.** For details, refer to the Safety Network Controller NX Series Catalog (Cat. No. F104).

## ■ Safety Network Controller

Product name	No. of I/O points			Model
	Safety inputs	Test outputs	Safety outputs	
Safety Network Controller	16	4	8	<b>NE1A-SCPU01-EIP</b>
	40	8	8	<b>NE1A-SCPU02-EIP</b>

**Note:** For details, refer to the website at: <http://www.ia.omron.com/>.

## ■ Safety Laser Scanner

Product name	Specifications		Model
		Max. Operating Range (Safety Zone)	
Safety Laser Scanner	OS32C with EtherNet/IP and back location cable entry	3m	<b>OS32C-BP-DM</b>
		4m	<b>OS32C-BP-DM-4M</b>
	OS32C with EtherNet/IP and side location cable entry *	3m	<b>OS32C-SP1-DM</b>
		4m	<b>OS32C-SP1-DM-4M</b>

\* For OS32C-SP1(-DM), each connector is located on the left as viewed from the back of the I/O block.

**Note1:** CD-ROM (Configuration tool)

**Note2:** For details, Refer to the Safety Laser Scanner OS32C Catalog (Cat. No. Z298).

## ■ Code Reader

Product name	Specifications	Model
Code Reader V430-F Series	All Code Reader	<b>V430-F□□□□□□□□□□</b>

**Note:** For details, refer to the MicroHAWK V430-F Series Datasheet (Cat.No.Q274).

## RFID System

Product name	Size	Model
RFID System V680S series Reader/Writer	50 × 50 × 30 mm	V680S-HMD63-EIP
	75 × 75 × 40 mm	V680S-HMD64-EIP
	120 × 120 × 40 mm	V680S-HMD66-EIP
UHF RFID System V780 Series Reader/Writer	250 × 250 × 70 mm	V780-HMD68-EIP-□□

Note: For details, Refer to the RFID System V680S Series Catalog (Cat. No. Q196), UHF RFID System V780 Series Catalog (Cat. No. Q256).

## Industrial Switching Hubs

Product name	Functions	No. of ports	Accessories	Current consumption (A)	Model
Industrial Switching Hubs	Quality of Service (QoS): EtherNet/IP control data priority 10/100BASE-TX, Auto-Negotiation	5	Power supply connector	0.07	W4S1-05D

## Laser Marker

Product name	Specifications	Model
Fiber Laser Marker MX-Z2000H series	All controllers	MX-Z20□□H(-□□)

Note: For details, refer to the Fiber Laser Marker MX-Z2000H-V1 series Catalog (Cat.No.Q269).

## Switch Mode Power Supply

Note: For details on normal stock models, contact your nearest OMRON representative.

### With Indication Monitor

Power rating	Rated input voltage	Rated output voltage (DC)	Rated output current	Maximum boost current	Model number
90 W	100 to 240 VAC (allowable range: 85 to 264 VAC, 90 to 350 VDC)	24 V	3.75 A	---	S8VK-X09024A-EIP
120 W		24 V	5 A	6 A	S8VK-X12024A-EIP
240 W		24 V	10 A	15 A	S8VK-X24024A-EIP
480 W		24 V	20 A	30 A	S8VK-X48024A-EIP

Note: For details, refer to the S8VK-X Catalog (Cat. No. T210).

### Without Indication Monitor

Power rating	Rated input voltage	Rated output voltage (DC)	Rated output current	Maximum boost current	Model number
30 W	100 to 240 VAC (allowable range: 85 to 264 VAC, 90 to 350 VDC)	5 V	5 A *1	6 A	S8VK-X03005-EIP
60 W		12 V	4.5 A *2	5.4 A	S8VK-X06012-EIP
		24 V	2.5 A	3 A	S8VK-X06024-EIP
90 W		24 V	3.75 A	---	S8VK-X09024-EIP
120 W		24 V	5 A	6 A	S8VK-X12024-EIP
240 W		24 V	10 A	15 A	S8VK-X24024-EIP
480 W		24 V	20 A	30 A	S8VK-X48024-EIP

Note: For details, refer to the S8VK-X Catalog (Cat. No. T210).

\*1. Output power is 25 W at rated output current.

\*2. Output power is 54 W at rated output current.

## Motor Condition Monitoring Device

Monitoring type	Power supply voltage	Model
Vibration & temperature type	100 to 240 VAC	K6CM-VBMA-EIP
	24 VAC/VDC	K6CM-VBMD-EIP
Insulation resistance type	100 to 240 VAC	K6CM-ISMA-EIP
	24 VAC/VDC	K6CM-ISMD-EIP
Comprehensive current diagnosis type	100 to 240 VAC	K6CM-CI2MA-EIP
	24 VAC/VDC	K6CM-CI2MD-EIP

Note: For details, refer to the Motor Condition Monitoring Device K6CM series Catalog (Cat. No. N218).

## ■ Software

### How to Select Required Support Software for Your Controller

The required Support Software depends on the Controller to connect. Please check the following table when purchasing the Support Software.

Controller	Software
NJ/NX/NY-series	Automation Software Sysmac Studio
CS, CJ, CP, and other series	FA Integrated Tool Package CX-One

### Automation Software Sysmac Studio

Please purchase a DVD and required number of licenses the first time you purchase the Sysmac Studio. DVDs and licenses are available individually. Each model of licenses does not include any DVD.

Product name	Specifications			Model
		Number of licenses	Media	
Sysmac Studio Standard Edition Ver.1.□□	<p>The Sysmac Studio is the software that provides an integrated environment for setting, programming, debugging and maintenance of machine automation controllers including the NJ/NX-series CPU Units, NY-series Industrial PC, EtherCAT Slave, and the HMI.</p> <p>Sysmac Studio runs on the following OS. *1 Windows 7 (32-bit/64-bit version)/Windows 8.1 (32-bit/64-bit version)/Windows 10(32-bit/64-bit version)/Windows 11(64-bit version)</p> <p>The Sysmac Studio Standard Edition DVD includes Support Software to set up EtherNet/IP Units, DeviceNet slaves, Serial Communications Units, and Support Software for creating screens on HMIs (CX-Designer). Refer to your OMRON website for details.</p>	— (Media only)	Sysmac Studio (32-bit) DVD	<b>SYSMAC-SE200D</b>
		— (Media only)	Sysmac Studio (64-bit) DVD	<b>SYSMAC-SE200D-64</b>
		1 license *2	—	<b>SYSMAC-SE201L</b>

\*1. Model "SYSMAC-SE200D-64" runs on Windows 10 (64 bit) or higher.

\*2. Multi licenses are available for the Sysmac Studio (3, 10, 30, or 50 licenses).

### FA Integrated Tool Package CX-One

Product name	Specifications			Model
		Number of licenses	Media	
FA Integrated Tool Package CX-One Ver. 4.□	<p>The CX-One is a comprehensive software package that integrates Support Software for OMRON PLCs and components.</p> <p>CX-One runs on the following OS. Windows 7 (32-bit/64-bit version)/Windows 8 (32-bit/64-bit version)/Windows 8.1 (32-bit/64-bit version)/Windows 10 (32-bit/64-bit version) CX-One Ver. 4.□ includes Network-Configurator. For details, refer to the CX-One Catalog (Cat. No. R134).</p>	1 license*	DVD	<b>CXONE-AL01D-V4</b>

\* Multi licenses are available for the CX-One (3, 10, 30, or 50 licenses). Site licenses are available for users who will run CX-One on multiple computers.

### ■ FA Communications Software (EtherNet/IP Compatible)

Name	Specifications	Model
CX- Compolet *	<p>Software components that can make it easy to create programs for communications between a computer and controllers. (Product includes CX-Compolet and SYSMAC Gateway functions.) Supported execution environment: .NET Framework (2.0, 3.0, 3.5, 4.0, 4.5.1, 4.6, 4.7 or 4.8) Development environment: Visual Studio 2010/2012/2013/2015/2017/2019 Development languages: Visual Basic, C# Supported communications: Equal to SYSMAC Gateway.</p>	<b>WS02-CPLC1</b>
SYSMAC Gateway	<p>Communications middleware for personal computers running Windows. Supports CIP communications and tag data links (EtherNet/IP) in addition to FinsGateway functions. (Fins Gateway functions are included.) Supported communications: RS-232C, USB, Controller Link, Ethernet, EtherNet/IP</p>	<b>WS02-SGWC1</b>

Supported OS: Windows 7 (32bit/64bit)/Windows 8 (32bit/64bit)/Windows 8.1 (32bit/64bit)/Windows 10 (32-bit/64-bit version)  
Windows Server 2008 (32bit/64bit)/Windows Server 2008 R2 (64bit)/Windows Server 2012 (64bit)/  
Windows Server 2012 R2 (64bit)/Windows Server 2016 (64bit)/Windows Server 2019 (64bit)

**Note.** One license is required per computer (execution environment).

For details, Refer to the FA Communications Software Catalog (Cat. No. V302).

\* A standalone product that does not include SYSMAC Gateway functions (WS02-CPI C2) is also available

## Read and Understand this Catalog

Please read and understand this catalog before purchasing the product. Please consult your OMRON representative if you have any questions or comments.

## Warranty and Limitations of Liability

### WARRANTY

OMRON's exclusive warranty is that the products are free from defects in materials and workmanship for a period of one year (or other period if specified) from date of sale by OMRON.

OMRON MAKES NO WARRANTY OR REPRESENTATION, EXPRESS OR IMPLIED, REGARDING NON-INFRINGEMENT, MERCHANTABILITY, OR FITNESS FOR PARTICULAR PURPOSE OF THE PRODUCTS. ANY BUYER OR USER ACKNOWLEDGES THAT THE BUYER OR USER ALONE HAS DETERMINED THAT THE PRODUCTS WILL SUITABLY MEET THE REQUIREMENTS OF THEIR INTENDED USE. OMRON DISCLAIMS ALL OTHER WARRANTIES, EXPRESS OR IMPLIED.

### LIMITATIONS OF LIABILITY

OMRON SHALL NOT BE RESPONSIBLE FOR SPECIAL, INDIRECT, OR CONSEQUENTIAL DAMAGES, LOSS OF PROFITS OR COMMERCIAL LOSS IN ANY WAY CONNECTED WITH THE PRODUCTS, WHETHER SUCH CLAIM IS BASED ON CONTRACT, WARRANTY, NEGLIGENCE, OR STRICT LIABILITY.

In no event shall the responsibility of OMRON for any act exceed the individual price of the product on which liability is asserted.

IN NO EVENT SHALL OMRON BE RESPONSIBLE FOR WARRANTY, REPAIR, OR OTHER CLAIMS REGARDING THE PRODUCTS UNLESS OMRON'S ANALYSIS CONFIRMS THAT THE PRODUCTS WERE PROPERLY HANDLED, STORED, INSTALLED, AND MAINTAINED AND NOT SUBJECT TO CONTAMINATION, ABUSE, MISUSE, OR INAPPROPRIATE MODIFICATION OR REPAIR.

## Application Considerations

### SUITABILITY FOR USE

OMRON shall not be responsible for conformity with any standards, codes, or regulations that apply to the combination of the product in the customer's application or use of the product.

At the customer's request, OMRON will provide applicable third party certification documents identifying ratings and limitations of use that apply to the products. This information by itself is not sufficient for a complete determination of the suitability of the products in combination with the end product, machine, system, or other application or use.

The following are some examples of applications for which particular attention must be given. This is not intended to be an exhaustive list of all possible uses of the products, nor is it intended to imply that the uses listed may be suitable for the products:

- Outdoor use, uses involving potential chemical contamination or electrical interference, or conditions or uses not described in this document.
- Nuclear energy control systems, combustion systems, railroad systems, aviation systems, medical equipment, amusement machines, vehicles, safety equipment, and installations subject to separate industry or government regulations.
- Systems, machines, and equipment that could present a risk to life or property.  
Please know and observe all prohibitions of use applicable to the products.

NEVER USE THE PRODUCT FOR AN APPLICATION INVOLVING SERIOUS RISK TO LIFE OR PROPERTY WITHOUT ENSURING THAT THE SYSTEM AS A WHOLE HAS BEEN DESIGNED TO ADDRESS THE RISKS, AND THAT THE OMRON PRODUCT IS PROPERLY RATED AND INSTALLED FOR THE INTENDED USE WITHIN THE OVERALL EQUIPMENT OR SYSTEM.

### PROGRAMMABLE PRODUCTS

OMRON shall not be responsible for the user's programming of a programmable product, or any consequence thereof.

## Disclaimers

### CHANGE IN SPECIFICATIONS

Product specifications and accessories may be changed at any time based on improvements and other reasons. Consult with your OMRON representative at any time to confirm actual specifications of purchased product.

### DIMENSIONS AND WEIGHTS

Dimensions and weights are nominal and are not to be used for manufacturing purposes, even when tolerances are shown.

### PERFORMANCE DATA

Performance data given in this catalog is provided as a guide for the user in determining suitability and does not constitute a warranty. It may represent the result of OMRON's test conditions, and the users must correlate it to actual application requirements. Actual performance is subject to the OMRON Warranty and Limitations of Liability.

**Note: Do not use this document to operate the Unit.**

**OMRON Corporation Industrial Automation Company**

**Kyoto, JAPAN**

**Contact : [www.ia.omron.com](http://www.ia.omron.com)**

**Regional Headquarters**

**OMRON EUROPE B.V.**

Wegalaan 67-69, 2132 JD Hoofddorp  
The Netherlands  
Tel: (31) 2356-81-300 Fax: (31) 2356-81-388

**OMRON ELECTRONICS LLC**

2895 Greenspoint Parkway, Suite 200  
Hoffman Estates, IL 60169 U.S.A.  
Tel: (1) 847-843-7900 Fax: (1) 847-843-7787

**OMRON ASIA PACIFIC PTE. LTD.**

438B Alexandra Road, #08-01/02 Alexandra  
Technopark, Singapore 119968  
Tel: (65) 6835-3011 Fax: (65) 6835-3011

**OMRON (CHINA) CO., LTD.**

Room 2211, Bank of China Tower,  
200 Yin Cheng Zhong Road,  
PuDong New Area, Shanghai, 200120, China  
Tel: (86) 21-6023-0333 Fax: (86) 21-5037-2388

**Authorized Distributor:**

©OMRON Corporation 2008-2023 All Rights Reserved.  
In the interest of product improvement,  
specifications are subject to change without notice.

**CSM\_32\_1**

**Cat. No. R150-E1-27 0623 (0908)**