

E3Z-LT/LR/LL

CSM_E3Z-LT_LR_LL_DS_E_7_1

Compact and Reliable Laser Photoelectric Sensor



- Safety and reliability with laser class 1 (JIS and IEC).
- Product lineup includes models with distance setting without influence of color.
- Maximum ambient operating temperature of 55°C and water-proof construction in E3Z class.



 Be sure to read *Safety Precautions* on page 9.

For the most recent information on models that have been certified for safety standards, refer to your OMRON website.

Applications

Detect the sides of large tiles.

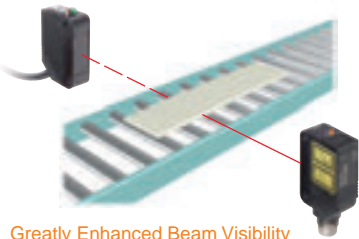

Greatly Enhanced Beam Visibility for Easier Optical Axis Adjustment of Sensors

Count bottles.

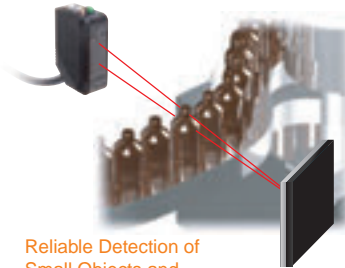

Reliable Detection of Small Objects and Narrow Gaps with the Small Spot

Detect chip components on tape.



Long-distance Sensing at 300 mm (White Paper)

Detect protruding straws.

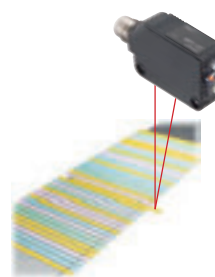





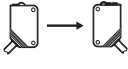

A Low Black/White Error for Applications with Mixed Colors

Ordering Information

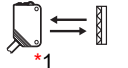
Sensors (Refer to Dimensions on page 11.)

 Red light

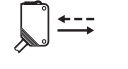
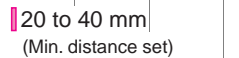
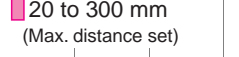
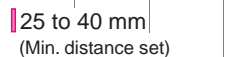
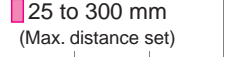
| Sensing method | Appearance | Connection method | Response time | Sensing distance | Model | |
|---------------------------------------|--|---------------------------|---|--|---|---|
| | | | | | NPN output | PNP output |
| Through-beam (Emitter + Receiver) |  | Pre-wired (2 m) | 1 ms |  60 m | E3Z-LT61 2M Emitter E3Z-LT61-L 2M Receiver E3Z-LT61-D 2M | E3Z-LT81 2M Emitter E3Z-LT81-L 2M Receiver E3Z-LT81-D 2M |
| | | Connector (M8, 4 pins) | | | E3Z-LT66 Emitter E3Z-LT66-L Receiver E3Z-LT66-D | E3Z-LT86 Emitter E3Z-LT86-L Receiver E3Z-LT86-D |
| Retro-reflective with MSR function |  *1 | Pre-wired (2 m) | |  *2 15 m (300 mm) (Using E39-R1) | E3Z-LR61 2M | E3Z-LR81 2M |
| | | Connector (M8, 4 pins) | |  7 m (200 mm) (Using E39-R12) | E3Z-LR66 | E3Z-LR86 |
| | | | |  7 m (200 mm) (Using E39-R6) | | |
| Distance-settable (BGS Models) |  | Pre-wired (2 m) | |  20 to 40 mm (Min. distance set) | E3Z-LL61 2M | E3Z-LL81 2M |
| | | Connector (M8, 4 pins) |  20 to 300 mm (Max. distance set) | | E3Z-LL66 | E3Z-LL86 |
| | | Pre-wired (2 m) | 0.5 ms |  25 to 40 mm (Min. distance set) | E3Z-LL63 2M | E3Z-LL83 2M |
| | | Connector (M8, 4 pins) | | |  25 to 300 mm (Max. distance set) | E3Z-LL68 |

*1. The Reflector is sold separately. Select the Reflector model most suited to the application.

*2. Values in parentheses indicate the minimum required distance between the Sensor and Reflector.

Accessories

Slits (A Slit is not provided with a Through-beam Sensor. Order a Slit separately if required.) (Refer to Dimensions on page 14.)









| Slit width | Sensing distance | Minimum detectable object (reference value) | Model | Contents |
|-------------|------------------|--|-----------------|--|
| 0.5 mm dia. | 3 m | 0.1 mm dia. | E39-S65A | One set (contains Slits for both the Emitter and Receiver) |

Reflectors (A Reflector is required for each Retro-reflective Sensor: A Reflector is not provided with the Sensor. Be sure to order a Reflector.)
(Refer to Dimensions on page 14.)

| Name | Sensing distance | | Model | Remarks |
|-----------|------------------|-----------------|----------------|---|
| | Rated value | Reference value | | |
| Reflector | — | 15 m (300 mm) | E39-R1 | <ul style="list-style-type: none"> Retro-reflective models are not provided with Reflectors. Separate the Sensor and the Reflector by at least the distance given in parentheses. The MSR function is enabled. |
| | 7 m (200 mm) | — | E39-R12 | |
| | — | 7 m (200 mm) | E39-R6 | |

Note: If you use the Reflector at any distance other than the rated distance, make sure that the stability indicator lights properly when you install the Sensor.

Mounting Brackets A Mounting Bracket is not provided with the Sensor. Order a Mounting Bracket separately if required.
 (Refer to *Dimensions* on E39-L/E39-S/E39-R.)

| Appearance | Model | Quantity | Remarks | Appearance | Model | Quantity | Remarks |
|--|----------------|----------|-------------------------------------|--|----------------|----------|--|
|  | E39-L153 *1 | 1 | Mounting Brackets |  | E39-L98 *2 | 1 | Metal Protective Cover Bracket |
|  | E39-L104 *1 | 1 | |  | E39-L150 | 1 set | (Sensor adjuster) |
|  | E39-L43 *2 | 1 | Horizontal Mounting Bracket |  | E39-L151 | 1 set | Easily mounted to the aluminum frame rails of conveyors and easily adjusted. For left to right adjustment |
|  | E39-L142 *2 | 1 | Horizontal Protective Cover Bracket | | | | |
|  | E39-L44 | 1 | Rear Mounting Bracket |  | E39-L144 *2 | 1 | Compact Protective Cover Bracket (For E3Z only) |

Note: When using a Through-beam Sensor, order one Mounting Bracket for the Receiver and one for the Emitter



*1. Cannot be used for Standard Connector models with mounting surface on the bottom. In that case, use Pre-wired Connector models.

*2. Cannot be used for Standard Connector models.

Sensor I/O Connectors (Sockets on One Cable End)

(Models for Connectors and Pre-wired Connectors: A Connector is not provided with the Sensor. Be sure to order a Connector separately.)

(Refer to *Dimensions* on XS3)

| Size | Cable | Appearance | Cable type | | Model |
|------|----------|--|------------|--------|-----------------|
| M8 | Standard | Straight *1  | 2 m | 4-wire | XS3F-M421-402-A |
| | | | 5 m | | XS3F-M421-405-A |
| | | L-shaped *1 *2  | 2 m | | XS3F-M422-402-A |
| | | | 5 m | | XS3F-M422-405-A |

Note: When using a Through-beam Sensor, order one Mounting Bracket for the Receiver and one for the Emitter

*1. The connector will not rotate after connecting.

*2. The cable is fixed at an angle of 180° from the sensor emitter/receiver surface.

Ratings and Specifications

| Sensing method | | Through-beam | Retro-reflective with MSR function | Distance-settable (BGS models) | |
|---|-----------------------|---|------------------------------------|---|--|
| Response | | Standard response | | | High-speed response |
| Item | Model | E3Z-LT61/-LT66 | E3Z-LR61/-LR66 | E3Z-LL61/-LL66 | E3Z-LL63/-LL68 |
| | NPN output | E3Z-LT81/-LT86 | E3Z-LR81/-LR86 | E3Z-LL81/-LL86 | E3Z-LL83/-LL88 |
| Sensing distance | | 60 m | 0.2 to 7 m (when using E39-R12) | White paper (100 × 100 mm): 20 to 300 mm Black paper (100 × 100 mm): 20 to 160 mm | White paper (100 × 100 mm): 25 to 300 mm Black paper (100 × 100 mm): 25 to 100 mm |
| Set distance range | | — | | White paper (100 × 100 mm): 40 to 300 mm Black paper (100 × 100 mm): 40 to 160 mm | White paper (100 × 100 mm): 40 to 300 mm Black paper (100 × 100 mm): 40 to 100 mm |
| Spot diameter (reference value) | | 5-mm dia. at 3 m | | 0.5-mm dia. at 300 mm | |
| Standard sensing object | | Opaque: 12-mm dia. min. | Opaque: 75-mm dia. min. | — | |
| Minimum detectable object (reference value) | | 6-mm-dia. opaque object at 3 m | | 0.2-mm-dia. stainless-steel pin gauge at 300 mm | |
| Differential travel | | --- | | 5% max. of set distance | |
| Black/white error | | --- | | 5% at 160 mm | 5% at 100 mm |
| Directional angle | | Receiver: 3 to 15° | | — | |
| Light source (wavelength) | | Red LD (655 nm), JIS C Class 1, IEC Class 1, FDA Class 2 | | | |
| Power supply voltage | | 12 to 24 VDC±10%, ripple (p-p): 10% max. | | | |
| Current consumption | | 35 mA (Emitter 15 mA, Receiver 20 mA) | 30 mA max. | | |
| Control output | | Load power supply voltage: 26.4 VDC max., Load current: 100 mA max., Open collector output | | | |
| Residual output voltage | | Load current of less than 10 mA: 1 V max. Load current of 10 to 100 mA: 2 V max. | | | |
| Output mode switching | | Switch to change between light-ON and dark-ON | | | |
| Protection circuits | | Reversed power supply polarity protection, Output short-circuit protection, and Reversed output polarity protection | | Reversed power supply polarity protection, Output short-circuit protection, Mutual interference prevention, and Reversed output polarity protection | |
| Response time | | Operate or reset: 1 ms max. | | | Operate or reset: 0.5 ms max. |
| Sensitivity adjustment | | One-turn adjuster | | Five-turn endless adjuster | |
| Ambient illumination (Receiver side) | | Incandescent lamp: 3,000 lx max. Sunlight: 10,000 lx max. | | | |
| Ambient temperature range | | Operating: -10 to 55°C, Storage: -25 to 70°C (with no icing or condensation) | | | |
| Ambient humidity range | | Operating: 35% to 85%, Storage: 35% to 95% (with no icing or condensation) | | | |
| Insulation resistance | | 20 MΩ min. at 500 VDC | | | |
| Dielectric strength | | 1,000 VAC, 50/60 Hz for 1 min | | | |
| Vibration resistance | | Destruction: 10 to 55 Hz, 1.5-mm double amplitude for 2 hours each in X, Y, and Z directions | | | |
| Shock resistance | | Destruction: 500 m/s ² 3 times each in X, Y, and Z directions | | | |
| Degree of protection | | IP67 (IEC 60529) | | | |
| Connection method | | Pre-wired cable (standard length: 2 m): | | E3Z-L□□1/-L□□3 | |
| | | Standard M8 Connector: | | E3Z-L□□6/-L□□8 | |
| Indicator | | Operation indicator (orange) Stability indicator (green) Emitter for Through-beam Models has power indicator (orange) only. | | | |
| Weight (packed state) | Pre-wired cable (2 m) | Approx. 120 g | Approx. 65 g | | |
| | Standard Connector | Approx. 30 g | Approx. 20 g | | |
| Material | Case | PBT (polybutylene terephthalate) | | | |
| | Lens | Modified polyarylate resin | Methacrylic resin | Modified polyarylate resin | |
| Accessories | | Instruction manual (Neither Reflectors nor Mounting Brackets are provided with any of the above models.) | | | |

Engineering Data (Reference Value)

Parallel Operating Range

Through-beam Models

E3Z-LT□□

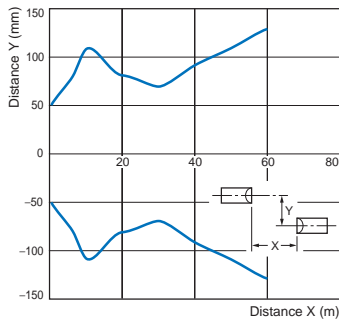

Through-beam Models

E3Z-LT□□ + E39-S65A

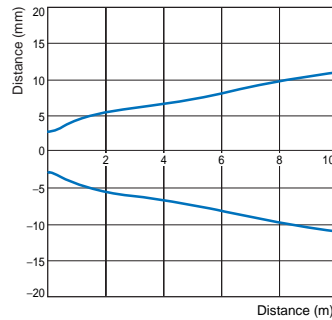

Retro-reflective Models

E3Z-LR□□

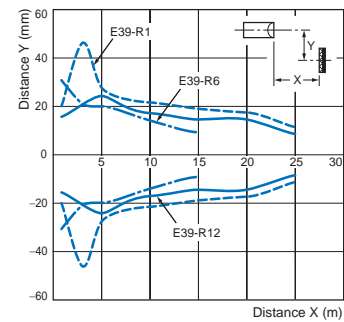

Operating Range at a Set Distance of 300 mm

BGS Models

E3Z-LL□□

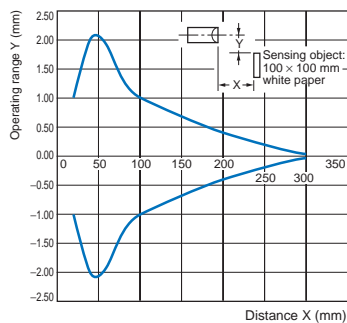

Operating Range at a Set Distance of 40 mm

BGS Models

E3Z-LL□□

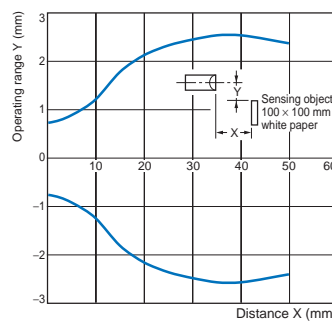

Excess Gain vs. Set Distance

Through-beam Models

E3Z-LT□□

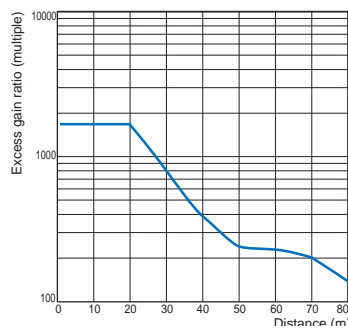

Retro-reflective Models

E3Z-LR□□

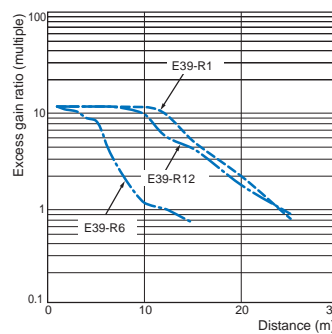

Close Range Characteristics

BGS Models

E3Z-LL□1/LL□6

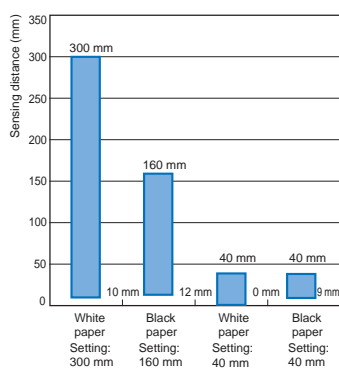

E3Z-LL□3/LL□8

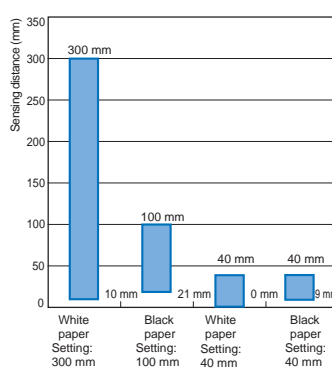

Sensing Distance vs. Sensing Object Material

BGS Models

E3Z-LL□1-/LL□6

White Paper with a Set Distance of 40 mm

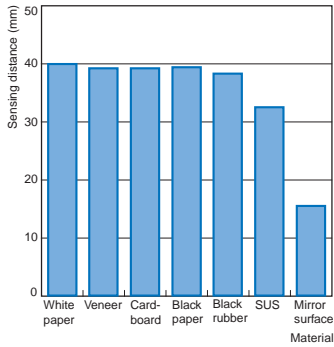

E3Z-LL□3-/LL□8

White Paper with a Set Distance of 40 mm

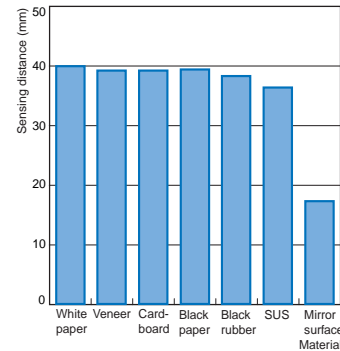

E3Z-LL□1-/LL□6

White Paper with a Set Distance of 300 mm

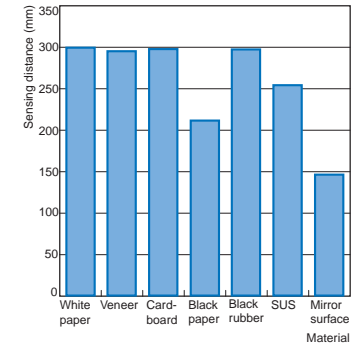

E3Z-LL□3-/LL□8

White Paper with a Set Distance of 100 mm

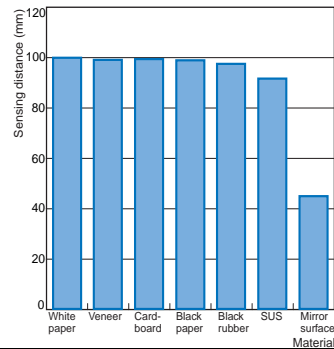

Emission Spot Diameter vs. Distance

Through-beam and Retro-reflective Models (Same for All Models)

E3Z-LT□□, E3Z-LR□□

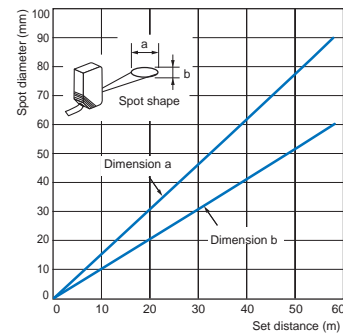

BGS Models (Same for All Models)

E3Z-LL□□

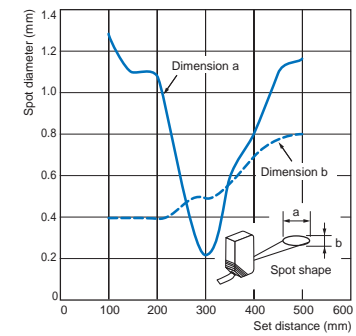

Hysteresis vs. Distance

BGS Models

E3Z-LL□1 (LL□6)

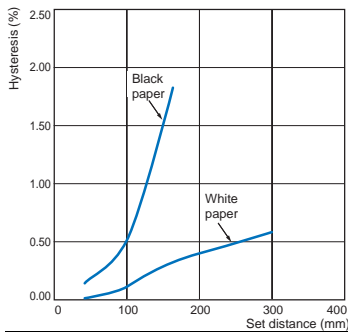

E3Z-LL□3 (LL□8)

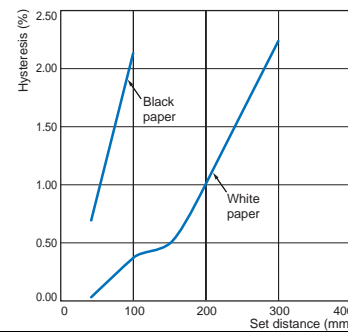

Inclination Characteristics (Vertical)

BGS Models

E3Z-LL□□

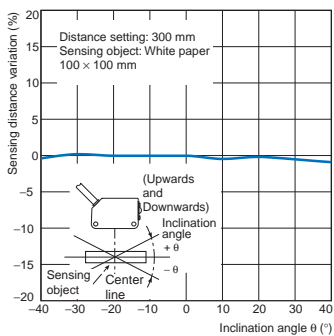

Inclination Characteristics (Horizontal)

BGS Models

E3Z-LL□□

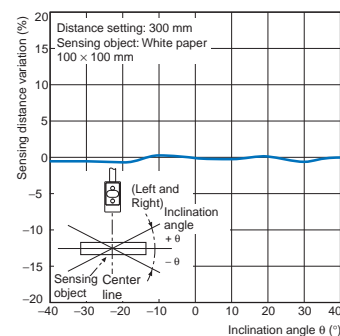

I/O Circuit Diagrams

NPN Output

| Model | Operation mode | Timing charts | Operation selector | Output circuit |
|--|----------------|---------------|----------------------|---|
| E3Z-LT61 * E3Z-LT66 * E3Z-LR61 E3Z-LR66 | Light-ON | | L side (LIGHT ON) | <p>M8 4-pin Connector Pin Arrangement</p> <p>Pin 2 is not used.</p> |
| | Dark-ON | | D side (DARK ON) | <p>M8 4-pin Connector Pin Arrangement</p> <p>Pins 2 and 4 are not used.</p> |
| E3Z-LL61 E3Z-LL66 E3Z-LL63 E3Z-LL68 | Light-ON | | L side (LIGHT ON) | <p>M8 4-pin Connector Pin Arrangement</p> <p>Pin 2 is not used.</p> |
| | Dark-ON | | D side (DARK ON) | <p>M8 4-pin Connector Pin Arrangement</p> <p>Pin 2 is not used.</p> |

PNP Output

| Model | Operation mode | Timing charts | Operation selector | Output circuit |
|--|----------------|---------------|----------------------|---|
| E3Z-LT81 * E3Z-LT86 * E3Z-LR81 E3Z-LR86 | Light-ON | | L side (LIGHT ON) | <p>M8 4-pin Connector Pin Arrangement</p> <p>Pin 2 is not used.</p> |
| | Dark-ON | | D side (DARK ON) | <p>M8 4-pin Connector Pin Arrangement</p> <p>Pins 2 and 4 are not used.</p> |
| E3Z-LL81 E3Z-LL86 E3Z-LL83 E3Z-LL88 | Light-ON | | L side (LIGHT ON) | <p>M8 4-pin Connector Pin Arrangement</p> <p>Pin 2 is not used.</p> |
| | Dark-ON | | D side (DARK ON) | <p>M8 4-pin Connector Pin Arrangement</p> <p>Pin 2 is not used.</p> |

* Models numbers for Through-beam Sensors (E3Z-LT□□) are for sets that include both the Emitter and Receiver. The model number of the Emitter is expressed by adding "L" to the set model number (example: E3Z-LT61-L 2M), the model number of the Receiver, by adding "-D" (example: E3Z-LT61-D 2M.) Refer to Ordering Information to confirm model numbers for Emitter and Receivers.

Plugs (Sensor I/O Connectors)

M8 4-pin Connectors

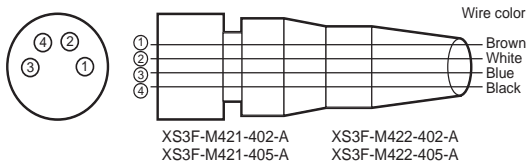

Nomenclature

Sensors with Sensitivity Adjustment and Mode Selector Switch

Through-beam Models

E3Z-LT□□ (Receiver)

Retro-reflective Models

E3Z-LR□□

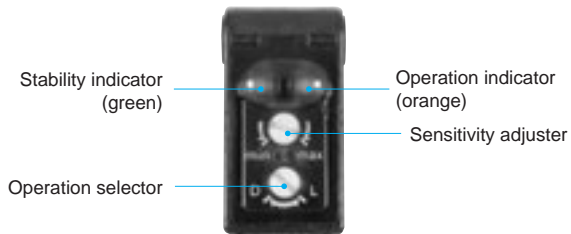

Distance-settable Sensor

BGS Models

E3Z-LL□□

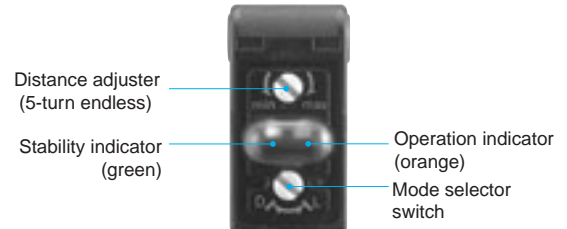

Safety Precautions

Refer to *Warranty and Limitations of Liability*.

WARNING

This product is not designed or rated for ensuring safety of persons. Do not use it for such purpose.



To ensure safe use of laser products, do not allow the laser beam to enter your eye. Direct exposure may adversely affect your eyesight.



CAUTION

Do not connect an AC power supply to the Sensor. If AC power (100 VAC or more) is supplied to the Sensor, it may explode or burn.



Precautions for Safe Use

Be sure to abide by the following precautions for the safe operation of the Sensor.

● Operating Environment

Do not use the Sensor in locations with explosive or flammable gas.

● Wiring

Power Supply Voltage and Output Load Power Supply Voltage

Make sure that the power supply to the Sensor is within the rated voltage range. If a voltage exceeding the rated voltage range is supplied to the Sensor, it may explode or burn.

Power Supply Voltage

The maximum power supply voltage is 26.4 VDC. Applying a voltage exceeding the rated range may damage the Sensor or cause burning.

Load

Do not use a load that exceeds the rated load.

Load Short-circuiting

Do not short-circuit the load, otherwise the Sensor may be damaged or it may burn.

Connection without Load

Do not connect the power supply to the Sensor with no load connected, otherwise the internal elements may explode or burn. Always connect a load when wiring.

Precautions for Correct Use

Do not use the product in atmospheres or environments that exceed product ratings.

● Laser Warning Labels

Be sure that the correct laser warning label (enclosed) is attached for the country of intended use of the equipment containing the Photoelectric Sensor. Refer to the user's manual for details.

● Usage Environment

Water Resistance

The Sensor is rated IP67. Do not use it in water, in the rain, or outdoors.

Ambient Environment

Do not install the product in the following locations. Doing so may result in product failure or malfunction.

- Locations subject to excess dust and dirt
- Locations subject to direct sunlight
- Locations subject to corrosive gas
- Locations subject to organic solvents
- Locations subject to shock or vibration
- Locations subject to exposure to water, oil, or chemicals
- Locations subject to high humidity or condensation

● Designing

Power Reset Time

The Sensor is ready to operate 100 ms after the Sensor is turned ON. If the load and Sensor are connected to independent power supplies respectively, be sure to turn ON the Sensor before supplying power to the load.

● Wiring

Avoiding Malfunctions

If using the Sensor with an inverter or servomotor, always ground the FG (frame ground) and G (ground) terminals, otherwise the Sensor may malfunction.

● Mounting

Mounting the Sensor

- If Sensors are mounted face-to-face, make sure that the optical axes are not in opposition to each other. Otherwise, mutual interference may result.
- Always install the Sensor carefully so that the aperture angle range of the Sensor will not cause it to be directly exposed to intensive light, such as sunlight, fluorescent light, or incandescent light.
- Do not strike the Photoelectric Sensor with a hammer or any other tool during the installation of the Sensor, or the Sensor will lose its water-resistive properties.
- Use M3 screws to mount the Sensor.
- When mounting the case, make sure that the tightening torque applied to each screw does not exceed 0.54 N·m.

Metal Connectors

- Always turn OFF the power supply to the Sensor before connecting or disconnecting the metal connector.
- Hold the connector cover to connect or disconnect it. If the XS3F is used, always tighten the connector cover by hand. Do not use pliers. If the tightening is insufficient, the degree of protection will not be maintained and the Sensor may become loose due to vibration. The appropriate tightening torque is 0.3 to 0.4 N·m. If other commercially available connectors are used, follow the recommended connector application conditions and recommended tightening torque specifications.

Mounting Direction for Distance-settable Models

- Make sure that the sensing side of the Sensor is parallel with the surface of the sensing objects. Normally, do not incline the Sensor towards the sensing object.

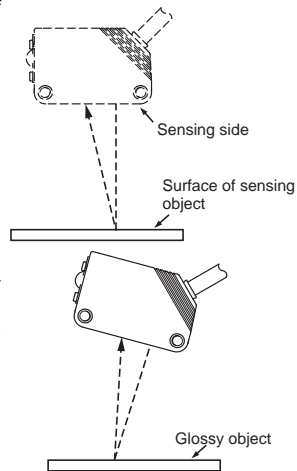

If the sensing object has a glossy surface, however, incline the Sensor by 5° to 10° as shown in the illustration, provided that the Sensor is not influenced by background objects.

- If there is a mirror-like object below the Sensor, the Sensor may not operate stably. Therefore, incline the Sensor or separate the Sensor from the mirror-like object as shown below.

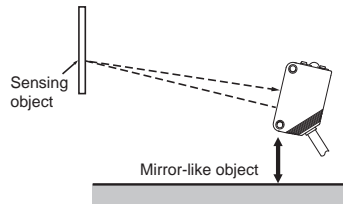

- Do not install the Sensor in the wrong direction. Refer to the following illustration.

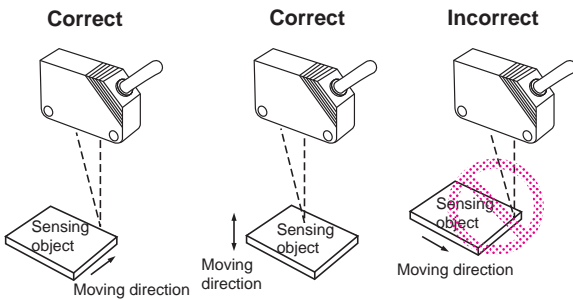

Install the Sensor as shown in the following illustration if each sensing object greatly differs in color or material.

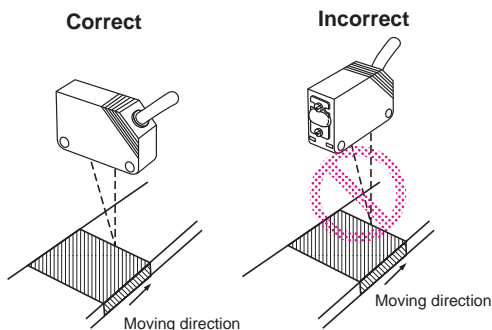

- The stability indicator may turn off in reaction to reflection from background objects. In such cases, incline the Sensor by 10° as shown in the illustration for more stable detection.

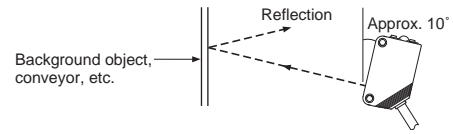

Adjusting Distance-settable Models Indicator Operation

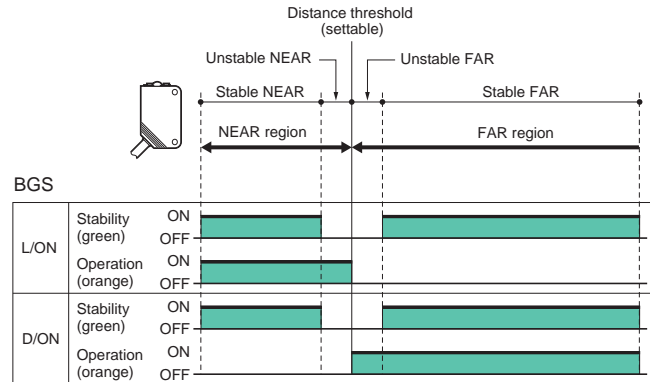

Note: If the stability indicator is lit, the detection/no detection status is stable within the rated ambient operating temperature (-10 to 55°C).

Inspection and Maintenance

Cleaning

Never use paint thinners or other organic solvents to clean the surface of the product.

Dimensions

Sensors

Through-beam* Pre-wired Models E3Z-LT61 E3Z-LT81

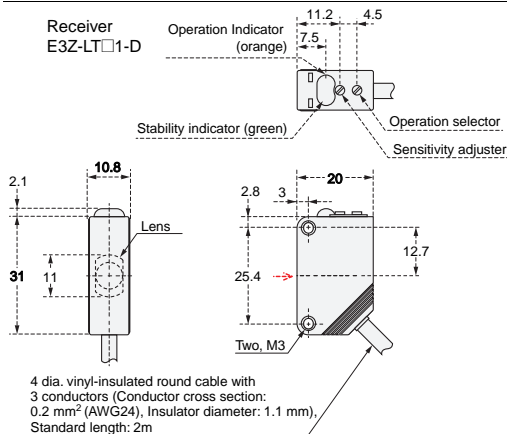
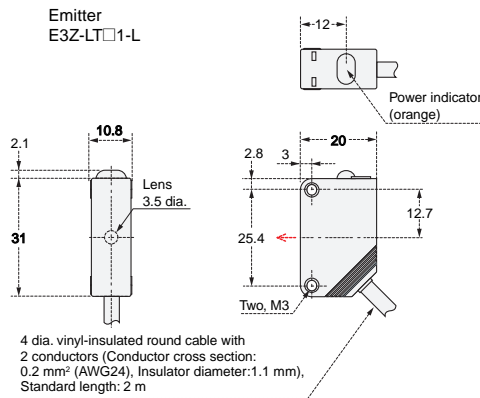

Through-beam* Standard Connector Models E3Z-LT66 E3Z-LT86

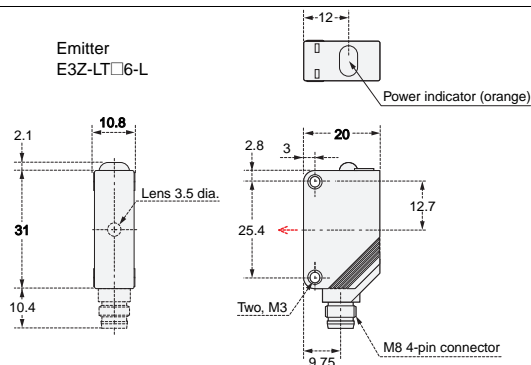

| Terminal No. | Specifications |
|--------------|----------------|
| 1 | +V |
| 2 | — |
| 3 | 0 V |
| 4 | — |

Pins 2 and 4 are not used.

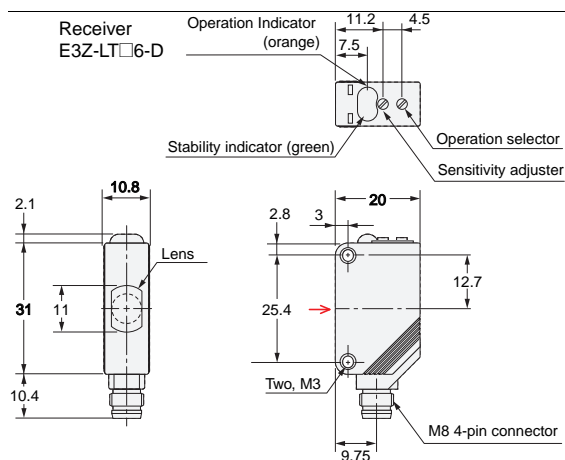

| Terminal No. | Specifications |
|--------------|----------------|
| 1 | +V |
| 2 | — |
| 3 | 0 V |
| 4 | Output |

Pins 2 is not used.

* Models numbers for Through-beam Sensors (E3Z-LT□□) are for sets that include both the Emitter and Receiver. The model number of the Emitter is expressed by adding "-L" to the set model number (example: E3Z-LT61-L 2M), the model number of the Receiver, by adding "-D" (example: E3Z-LT61-D 2M.) Refer to Ordering Information to confirm model numbers for Emitter and Receivers.

Retro-reflective Models

Pre-wired Models

E3Z-LR61

E3Z-LR81

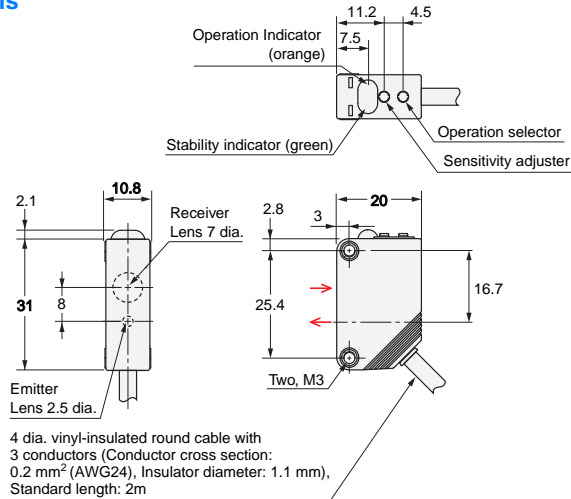

Retro-reflective Models

Standard Connector Models

E3Z-LR66

E3Z-LR86

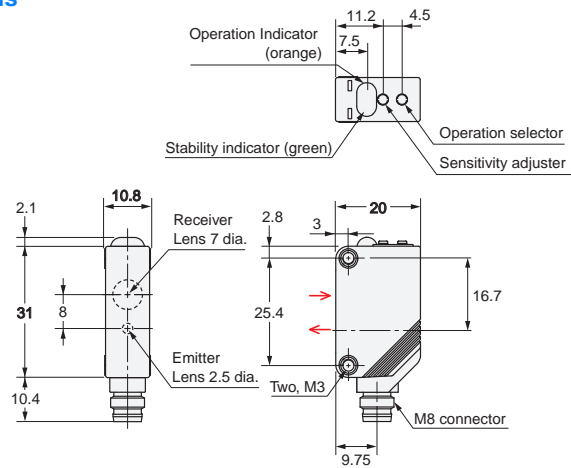

| Terminal No. | Specifications |
|--------------|----------------|
| 1 | +V |
| 2 | — |
| 3 | 0 V |
| 4 | Output |

Pins 2 is not used.

BGS Models

Pre-wired Models

E3Z-LL61

E3Z-LL81

E3Z-LL63

E3Z-LL83

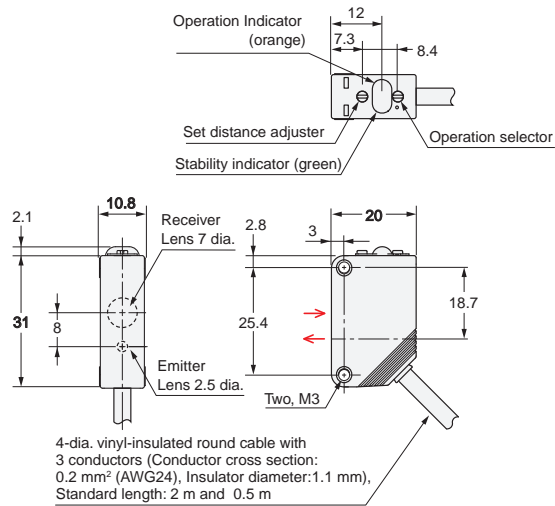

BGS Models

Standard M8

Connector Models

E3Z-LL66

E3Z-LL86

E3Z-LL68

E3Z-LL88

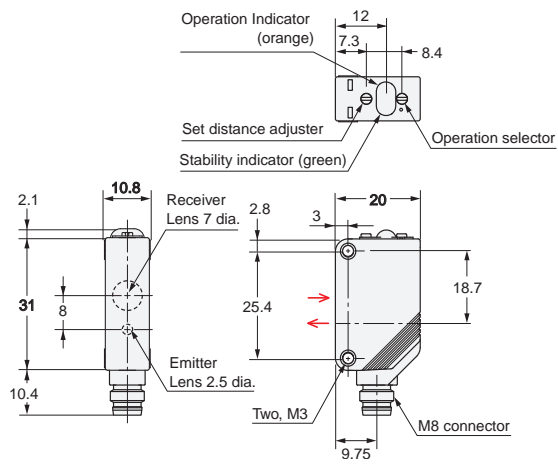

| Terminal No. | Specifications |
|--------------|----------------|
| 1 | +V |
| 2 | — |
| 3 | 0 V |
| 4 | Output |

Pins 2 is not used.

Accessories (Order Separately)

Slit E39-S65A

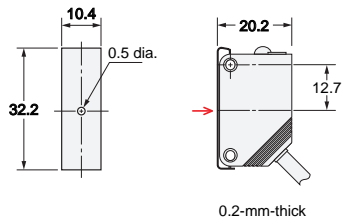

Material
SUS301 stainless steel

Reflector E39-R1

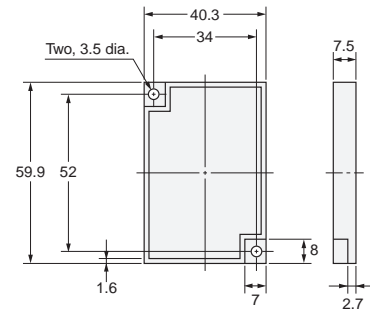

Materials
Reflective surface: Acrylic
Rear surface: ABS

Reflector E39-R6

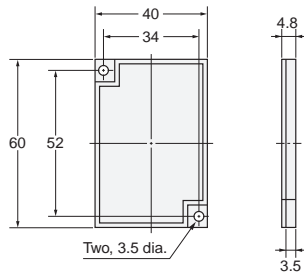

Materials
Reflective surface: Acrylic
Rear surface: ABS

Reflector E39-R12

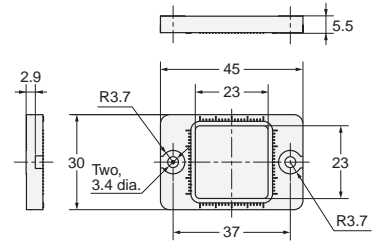

Materials
Reflector: Polycarbonate (surface)
Acrylic (interior)
Frame: ABS

Terms and Conditions Agreement

Read and understand this catalog.

Please read and understand this catalog before purchasing the products. Please consult your OMRON representative if you have any questions or comments.

Warranties.

(a) Exclusive Warranty. Omron's exclusive warranty is that the Products will be free from defects in materials and workmanship for a period of twelve months from the date of sale by Omron (or such other period expressed in writing by Omron). Omron disclaims all other warranties, express or implied.

(b) Limitations. OMRON MAKES NO WARRANTY OR REPRESENTATION, EXPRESS OR IMPLIED, ABOUT NON-INFRINGEMENT, MERCHANTABILITY OR FITNESS FOR A PARTICULAR PURPOSE OF THE PRODUCTS. BUYER ACKNOWLEDGES THAT IT ALONE HAS DETERMINED THAT THE PRODUCTS WILL SUITABLY MEET THE REQUIREMENTS OF THEIR INTENDED USE.

Omron further disclaims all warranties and responsibility of any type for claims or expenses based on infringement by the Products or otherwise of any intellectual property right. (c) Buyer Remedy. Omron's sole obligation hereunder shall be, at Omron's election, to (i) replace (in the form originally shipped with Buyer responsible for labor charges for removal or replacement thereof) the non-complying Product, (ii) repair the non-complying Product, or (iii) repay or credit Buyer an amount equal to the purchase price of the non-complying Product; provided that in no event shall Omron be responsible for warranty, repair, indemnity or any other claims or expenses regarding the Products unless Omron's analysis confirms that the Products were properly handled, stored, installed and maintained and not subject to contamination, abuse, misuse or inappropriate modification. Return of any Products by Buyer must be approved in writing by Omron before shipment. Omron Companies shall not be liable for the suitability or unsuitability or the results from the use of Products in combination with any electrical or electronic components, circuits, system assemblies or any other materials or substances or environments. Any advice, recommendations or information given orally or in writing, are not to be construed as an amendment or addition to the above warranty.

See <http://www.omron.com/global/> or contact your Omron representative for published information.

Limitation on Liability: Etc.

OMRON COMPANIES SHALL NOT BE LIABLE FOR SPECIAL, INDIRECT, INCIDENTAL, OR CONSEQUENTIAL DAMAGES, LOSS OF PROFITS OR PRODUCTION OR COMMERCIAL LOSS IN ANY WAY CONNECTED WITH THE PRODUCTS, WHETHER SUCH CLAIM IS BASED IN CONTRACT, WARRANTY, NEGLIGENCE OR STRICT LIABILITY.

Further, in no event shall liability of Omron Companies exceed the individual price of the Product on which liability is asserted.

Suitability of Use.

Omron Companies shall not be responsible for conformity with any standards, codes or regulations which apply to the combination of the Product in the Buyer's application or use of the Product. At Buyer's request, Omron will provide applicable third party certification documents identifying ratings and limitations of use which apply to the Product. This information by itself is not sufficient for a complete determination of the suitability of the Product in combination with the end product, machine, system, or other application or use. Buyer shall be solely responsible for determining appropriateness of the particular Product with respect to Buyer's application, product or system. Buyer shall take application responsibility in all cases.

NEVER USE THE PRODUCT FOR AN APPLICATION INVOLVING SERIOUS RISK TO LIFE OR PROPERTY OR IN LARGE QUANTITIES WITHOUT ENSURING THAT THE SYSTEM AS A WHOLE HAS BEEN DESIGNED TO ADDRESS THE RISKS, AND THAT THE OMRON PRODUCT(S) IS PROPERLY RATED AND INSTALLED FOR THE INTENDED USE WITHIN THE OVERALL EQUIPMENT OR SYSTEM.

Programmable Products.

Omron Companies shall not be responsible for the user's programming of a programmable Product, or any consequence thereof.

Performance Data.

Data presented in Omron Company websites, catalogs and other materials is provided as a guide for the user in determining suitability and does not constitute a warranty. It may represent the result of Omron's test conditions, and the user must correlate it to actual application requirements. Actual performance is subject to the Omron's Warranty and Limitations of Liability.

Change in Specifications.

Product specifications and accessories may be changed at any time based on improvements and other reasons. It is our practice to change part numbers when published ratings or features are changed, or when significant construction changes are made. However, some specifications of the Product may be changed without any notice. When in doubt, special part numbers may be assigned to fix or establish key specifications for your application. Please consult with your Omron's representative at any time to confirm actual specifications of purchased Product.

Errors and Omissions.

Information presented by Omron Companies has been checked and is believed to be accurate; however, no responsibility is assumed for clerical, typographical or proofreading errors or omissions.