

Extremely Thin Relays Integrated with Heat Sinks

- Downsizing achieved through optimum design of heat sink.
 - Mounting possible via screws or via DIN track.
 - Close mounting possible for linking terminals. (Except for G3PA-260B-VD and G3PA-450B-VD-2.)
 - Applicable with 3-phase loads.
 - Replaceable power element cartridges.
 - Comply with VDE 0160 (finger protection), with a dielectric strength of 4,000 V between input and load.
 - Certified by UL, CSA, and VDE (reinforced insulation). *
- * Only UL and CSA certification applies to model numbers that end in -VD-X.



* Not applicable to model numbers that end in -VD-X.



Note: Manufacture of the following models will be discontinued at the end of March 2017: G3PA-210B-VD, G3PA-220B-VD, G32A-A10-VD, and G32A-A20VD.

For the most recent information on models that have been certified for safety standards, refer to your OMRON website.

 Refer to *Safety Precautions for All Solid State Relays*.

Model Number Structure

Model Number Legend

G3PA-□□□□-□-□
 1 2 3 4 5 6 7

- 1. Basic Model Name**
G3PA: Solid State Relay
- 2. Rated Load Power Supply Voltage**
2: 200 VAC
4: 400 VAC
- 3. Rated Load Current**
10: 10 A
20: 20 A
30: 30 A
40: 40 A
50: 50 A
60: 60 A
- 4. Terminal Type**
B: Screw terminals
- 5. Zero Cross Function**
Blank: Equipped with zero cross function
L: Not equipped with zero cross function
- 6. Certification**
VD: Certified by UL, CSA, and VDE
- 7. Special Specifications**
Blank: Standard models
2: 480-V models
X: Non-compliant of EN standard (CE mark)

Ordering Information

List of Models

Model	Isolation	Zero cross function	Indicator	Rated output load	Rated input voltage	
G3PA-210B-VD-X	Phototriac coupler	Yes	Yes	10 A at 24 to 240 VAC	5 to 24 VDC	
G3PA-210B-VD *				20 A at 24 to 240 VAC		
G3PA-220B-VD-X				40 A at 24 to 240 VAC		
G3PA-220B-VD *				60 A at 24 to 240 VAC		
G3PA-240B-VD				10 A at 24 to 240 VAC		
G3PA-260B-VD				20 A at 24 to 240 VAC		
G3PA-210BL-VD		No		40 A at 24 to 240 VAC	10 A at 24 to 240 VAC	24 VAC
G3PA-220BL-VD				20 A at 24 to 240 VAC		
G3PA-240BL-VD				60 A at 24 to 240 VAC		
G3PA-260BL-VD				10 A at 24 to 240 VAC		
G3PA-210B-VD		Yes		Yes	20 A at 24 to 240 VAC	12 to 24 VDC
G3PA-220B-VD					40 A at 24 to 240 VAC	
G3PA-240B-VD					60 A at 24 to 240 VAC	
G3PA-260B-VD					20 A at 200 to 400 VAC	
G3PA-420B-VD					30 A at 200 to 400 VAC	
G3PA-430B-VD					20 A at 200 to 480 VAC	
G3PA-420B-VD-2	30 A at 200 to 480 VAC					
G3PA-430B-VD-2	50 A at 200 to 480 VAC					
G3PA-450B-VD-2						

Note: When ordering, specify the rated input voltage.

* Manufacture will be discontinued at the end of March 2017.

Replacement Parts

Name	Carry current	Load voltage range	Model	Applicable SSR	VDE certification		
Power Device Cartridge	10 A	19 to 264 VAC	G32A-A10-VD-X DC5-24	G3PA-210B-VD DC5-24 G3PA-210B-VD-X DC5-24	No		
			G32A-A10-VD DC5-24 *	G3PA-210B-VD DC5-24	Yes		
			G32A-A10L-VD DC5-24	G3PA-210BL-VD DC5-24	No		
			G32A-A10-VD AC24	G3PA-210B-VD AC24			
			20 A	G32A-A20-VD-X DC5-24	G3PA-220B-VD DC5-24 G3PA-220B-VD-X DC5-24	No	
				G32A-A20-VD DC5-24 *	G3PA-220B-VD DC5-24	Yes	
	G32A-A20L-VD DC5-24			G3PA-220BL-VD DC5-24			
	G32A-A20-VD AC24			G3PA-220B-VD AC24			
	40 A			G32A-A40-VD DC5-24	G3PA-240B-VD DC5-24		No
				G32A-A40L-VD DC5-24	G3PA-240BL-VD DC5-24		
			G32A-A40-VD AC24	G3PA-240B-VD AC24			
			60 A	G32A-A60-VD DC5-24	G3PA-260B-VD DC5-24	Yes	
				G32A-A60L-VD DC5-24	G3PA-260BL-VD DC5-24		
				G32A-A60-VD AC24	G3PA-260B-VD AC24		
	20 A			180 to 440 VAC	G32A-A420-VD DC12-24		G3PA-420B-VD DC12-24
					G32A-A430-VD DC12-24		G3PA-430B-VD DC12-24
					30 A		180 to 528 VAC
	G32A-A430-VD-2 DC12-24		G3PA-430B-VD-2 DC12-24				
50 A	G32A-A450-VD-2 DC12-24	G3PA-450B-VD-2 DC12-24					

* Manufacture will be discontinued at the end of March 2017.

Other Units (Order Separately)

Units that Enable 2-line Switching of 3-phase Power

Name	Current flow	Model	Applicable SSR
Short-circuit Unit	10 A	G32A-D20	G3PA-210B-VD-X, G3PA-210BL-VD
	20 A		G3PA-220B-VD-X, G3PA-220BL-VD G3PA-420B-VD, G3PA-420B-VD-2
	30 A	G32A-D40	G3PA-430B-VD, G3PA-430B-VD-2
	40 A		G3PA-240B-VD, G3PA-240BL-VD

Note: Refer to *List of Certified Models* for a list of products that comply with safety standards.

Specifications

■ Ratings (at an Ambient Temperature of 25°C)

Input

Model	Rated voltage	Operating Voltage range	Input current impedance	Voltage level	
				Must operate voltage	Must release voltage
G3PA-210B-VD-X	5 to 24 VDC	4 to 30 VDC	7 mA max.	4 VDC max.	1 VDC min.
G3PA-220B-VD-X					
G3PA-240B-VD					
G3PA-260B-VD					
G3PA-210BL-VD	5 to 24 VDC	4 to 30 VDC	20 mA max.	4 VDC max.	1 VDC min.
G3PA-220BL-VD					
G3PA-240BL-VD					
G3PA-260BL-VD					
G3PA-210B-VD	24 VAC	19.2 to 26.4 VAC	1.4 kΩ±20%	19.2 VAC max.	4.8 VAC min.
G3PA-220B-VD					
G3PA-240B-VD					
G3PA-260B-VD					
G3PA-420B-VD	12 to 24 VDC	9.6 to 30 VDC	7 mA max.	9.2 VDC max.	1 VDC min.
G3PA-430B-VD					
G3PA-420B-VD-2					
G3PA-430B-VD-2					
G3PA-450B-VD-2					

Output

Model	Rated load voltage	Load voltage range	Load current	Inrush current	V _{DRM} (reference value)
G3PA-210B(L)-VD(-X)	24 to 240 VAC (50/60 Hz)	19 to 264 VAC (50/60 Hz)	0.1 to 10 A at 40°C	150 A (60 Hz, 1 cycle)	600 V (V _{DRM})
G3PA-220B(L)-VD(-X)			0.1 to 20 A at 40°C	220 A (60 Hz, 1 cycle)	
G3PA-240B(L)-VD			0.5 to 40 A at 40°C	440 A (60 Hz, 1 cycle)	
G3PA-260B(L)-VD			0.5 to 60 A at 40°C	440 A (60 Hz, 1 cycle)	
G3PA-420B-VD	200 to 400 VAC (50/60 Hz)	180 to 440 VAC (50/60 Hz)	0.5 to 20 A at 30°C	220 A (60 Hz, 1 cycle)	1,000 V (V _{DRM})
G3PA-430B-VD			0.5 to 30 A at 30°C	440 A (60 Hz, 1 cycle)	
G3PA-420B-VD-2	200 to 480 VAC (50/60 Hz)	180 to 528 VAC (50/60 Hz)	0.5 to 20 A at 30°C	220 A (60 Hz, 1 cycle)	1,200 V (V _{DRM})
G3PA-430B-VD-2			0.5 to 30 A at 30°C	440 A (60 Hz, 1 cycle)	
G3PA-450B-VD-2			0.5 to 50 A at 30°C	440 A (60 Hz, 1 cycle)	

Refer to *Engineering Data* for further details.

■ Characteristics

Item	G3PA-210B(L)-VD(-X)	G3PA-220B(L)-VD(-X)	G3PA-240B(L)-VD	G3PA-260B(L)-VD	G3PA-420B-VD	G3PA-420B-VD-2	G3PA-430B-VD	G3PA-430B-VD-2	G3PA-450B-VD-2
Operate time	1/2 of load power source cycle + 1 ms max. (DC Input, -B models) 1 1/2 of load power source cycle + 1 ms max. (AC Input) 1 ms max. (-BL models)								
Release time	1/2 of load power source cycle + 1 ms max. (DC Input) 1 1/2 of load power source cycle + 1 ms max. (AC Input)								
Output ON voltage drop	1.6 V (RMS) max.				1.8 V (RMS) max.				
Leakage current	5 mA max. (at 100 VAC) 10 mA max. (at 200 VAC)		10 mA max. (at 100 VAC) 20 mA max. (at 200 VAC)		20 mA max. (at 400 VAC)	20 mA max. (at 480 VAC)	20 mA max. (at 400 VAC)	20 mA max. (at 480 VAC)	
I ² t	260 A ² s		1,260 A ² s		260 A ² s	1,800 A ² s	1,800 A ² s		1,800 A ² s
Insulation resistance	100 MΩ min. (at 500 VDC)								
Dielectric strength	4,000 VAC, 50/60 Hz for 1 min								
Vibration resistance	Destruction: 10 to 55 to 10 Hz, 0.375–mm single amplitude (Mounted to DIN track)								
Shock resistance	Destruction: 300 m/s ² (mounted to DIN track)								
Ambient temperature	Operating: –30°C to 80°C (with no icing or condensation) Storage: –30°C to 100°C (with no icing or condensation)								
Certified standards	UL (File No.E64562), CSA (File No.LR35535) VDE (Certificate No.5915, EN62314 (G3PA-2□-VD(-X)) / No.6642 (G3PA-450B-VD-2), 40040715 (G3PA-420B-VD(-2), G3PA-430B-VD(-2)), EN60947-4-3 (G3PA-4□-VD))								
EMC	Emission: EN55011 Group 1 Class A Immunity: EN61000-6-2								
Ambient humidity	Operating: 45% to 85%								
Weight	Approx. 260 g	Approx. 340 g	Approx. 460 g	Approx. 900 g	Approx. 290 g	Approx. 290 g	Approx. 410 g	Approx. 410 g	Approx. 900 g

Operation

■ Replacement Parts

G32A-A Power Device Cartridge

The G32A-A Power Device Cartridge (a Triac Unit) can be replaced with a new one. When the temperature indicator has changed from pink to red, the triac circuitry may have malfunctioned possibly by an excessive flow of current, in which case, dismantle the damaged cartridge for replacement.

The damaged cartridge can be replaced with a new one without disconnecting the wires from the G3PA.

Improve the heat radiation efficiency of the G3PA before replacing the cartridge.

The G32A-A Power Device Cartridge can withstand an excessive current for a short period of time, such as may be caused accidentally by the short circuitry of the load, in which case the temperature indicator will not turn red.

Be sure to turn OFF the power supply when replacing the Cartridge. Supplying power with the Cartridge removed may result in malfunction.

To remove or replace the Power Device Cartridge for the G3PA-210B(L)-VD(-X), G3PA-220B(L)-VD(-X), or G3PA-420B-VD(-2), use the special tool provided with it for extraction. (No special tool is required for other models.)

The G3PA can be broadly divided into two series: Previous models and models with model numbers that end with "-VD." The Cartridge shown at the right cannot be mounted to models in the G3PA-□□□B(-US) Series.

Appearance

G32A-A10(L)-VD(-X)

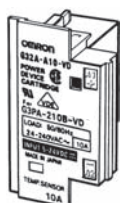

G32A-A20(L)-VD(-X)

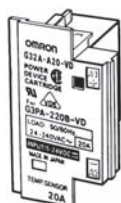

G32A-A40(L)-VD

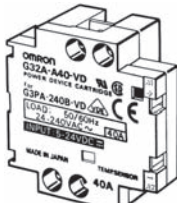

G32A-A60(L)-VD

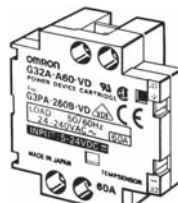

G32A-A420-VD(-2)

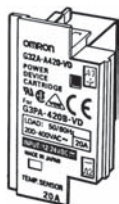

G32A-A430-VD(-2)

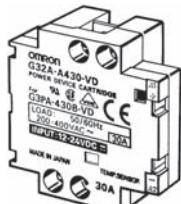

G32A-A450-VD-2

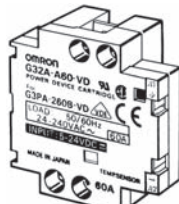

Replacing Power Device Cartridges

When replacing Power Device Cartridges, use the specified model. Using a Power Device Cartridge other than the specified one will result in faulty operation and destruction of the elements.

■ Replacement Procedure

G32A-A10(L)-VD(-X)/G32A-A20(L)-VD(-X)/G32-A420-VD(-2)

To remove or replace the Power Device Cartridge, use the special tool provided with it for extraction.
(Do not switch on the power without the Power Device Cartridge. For details, see the attached the instruction sheet with the product.)

Extraction

Follow the procedures below to dismantle the Power Device Cartridge from the G3PA.

1. Switch off the power.
2. Remove the terminal cover.
3. Hook the indented part of the cartridge with the tool and pull up on the cartridge to remove it.

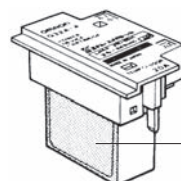
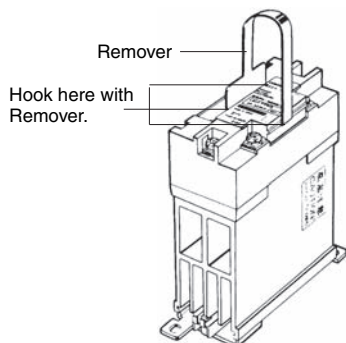

2. Make sure that there is no dust or pieces of wire on the heat sink of the G32A-A or the G3PA.
3. Insert the cartridge into the opening of the G3PA so that the letters on the cartridge and those on the G3PA are in the same direction and side A and side B are even.

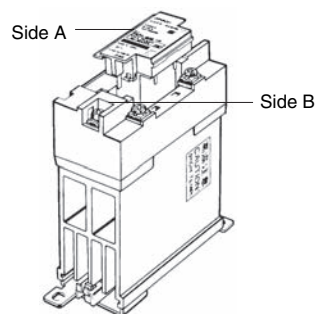

Mounting

Follow the procedures below to mount the Power Device Cartridge on the G3PA.

1. Apply silicone grease (provided with the G32A-A) to the entire surface of the heat sink.
4. Attach the terminal cover.
5. Switch on the power and check the G3PA to be sure it works properly.

G32A-A40(L)-VD/G32A-A60(L)-VD/G32A-A430-VD(-2)/G32A-A450-VD-2

The G32A Power Device Cartridge is mounted and secured with screws to the G3PA Unit. No special tool is required to remove the Cartridge.

Extraction

Follow the procedures below to dismantle the G32A-A Power Device Cartridge from the G3PA.

1. Switch off the power.
2. Remove the terminal cover.
3. Loosen the two centered screws on the sides to dismantle the cartridge. The screws are connected to terminals 1 and 2.

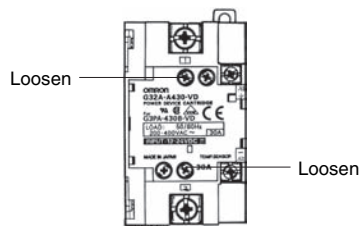

4. Loosen the screws on both the corners.

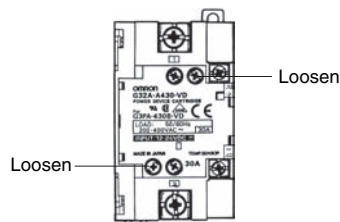

5. Hold the indented part of both the corners to dismantle the cartridge.

Mounting

1. Apply silicone grease to the entire surface of the heat sink.

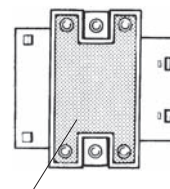

2. Make sure that there is no dust or pieces of wire on the heat sink of the G32A-A or the G3PA.

3. Insert the cartridge into the opening of the G3PA so that side A and side B are even.

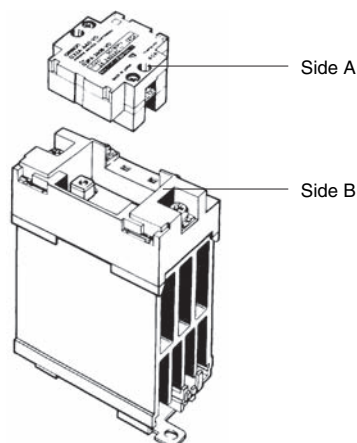

4. Tighten the screws on both the corners with a tightening torque of 0.59 to 0.78 N·m.
5. Tighten the screws on both the sides with a tightening torque of 0.59 to 0.78 N·m.
6. Attach the terminal cover.
7. Switch on the power and check the G3PA to be sure it works properly.

■ Linking Terminal Connection

- Connecting with linking terminal for G3PA-210B(L)-VD(-X), -220B(L)-VD(-X), -240B(L)-VD and G3PA-420B-VD(-2), G3PA-430B-VD(-2).

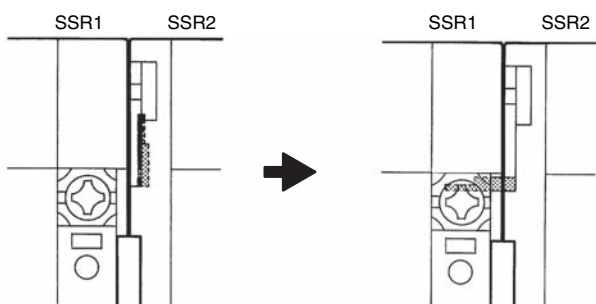

1. When SSRs are close mounted, loosen the M3.5 Sems screw and flip the linking terminal down.

2. Insert the linking terminal securely into the center of the screw and tighten the screw.

- Connecting with linking terminal for G32A.

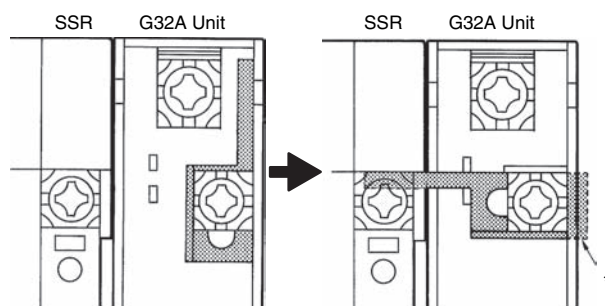

* The cover will not fit if the terminal protrudes.

1. When SSR are close mounted, loosen the M3.5 Sems screw on the G32A and flip the linking terminal down.

2. Insert the linking terminal securely into the center of the screw and tighten the screw. Ensure that the linking terminal does not protrude.

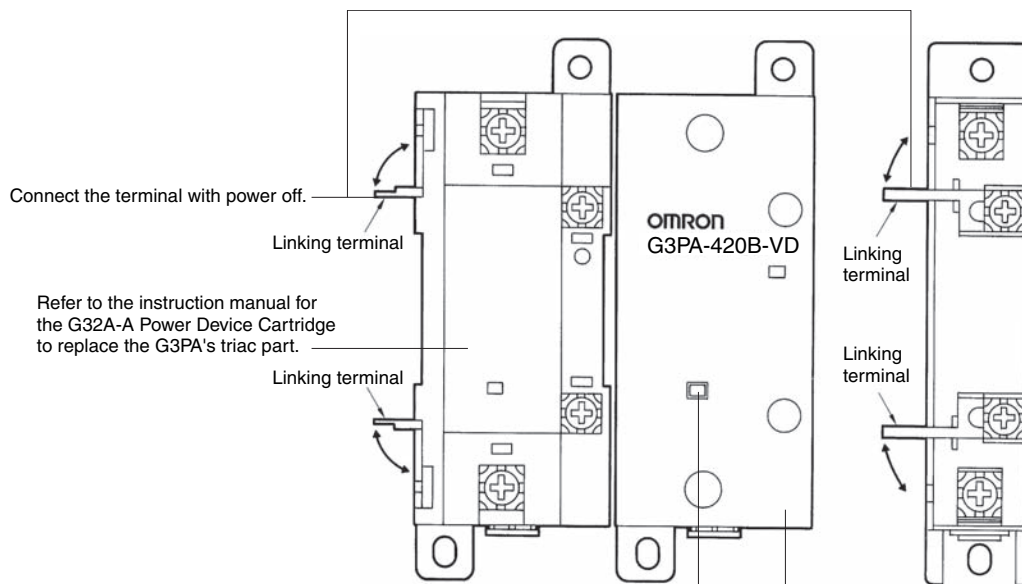

When the temperature indicator has turned from pink to red, the G32A-A Power Device Cartridge may have malfunctioned, in which case the cartridge must be replaced with a new one.

Use the terminal cover to prevent accidents due to electric shock.

Engineering Data

Load Current vs. Ambient Temperature

Vertical Mounting

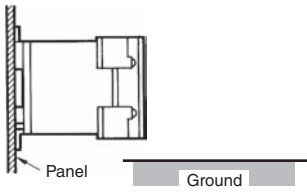

**G3PA-210B(L)-VD(-X),
G3PA-220B(L)-VD(-X)**

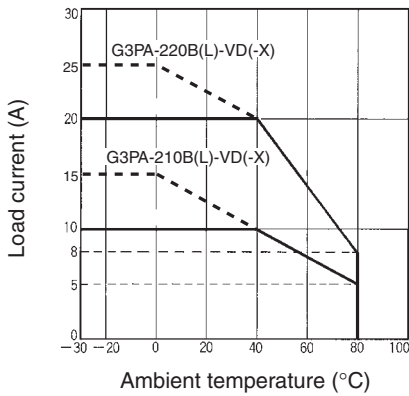

G3PA-240B(L)-VD

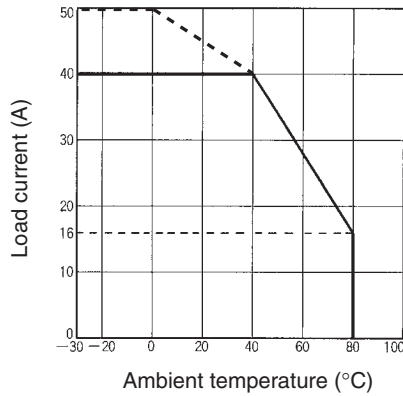

G3PA-260B(L)-VD

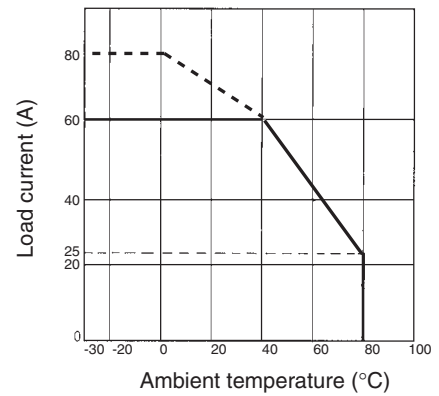

For close mounting of two or three SSRs, limit the load current to 90% or less.

G3PA-420B-VD, G3PA-420B-VD-2

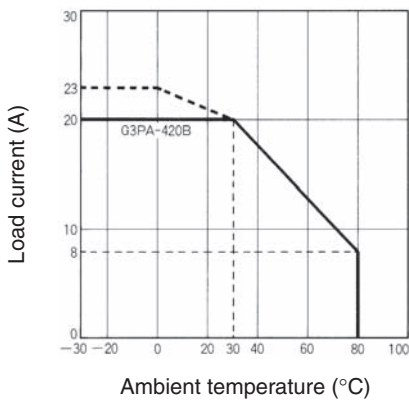

G3PA-430B-VD, G3PA-430B-VD-2

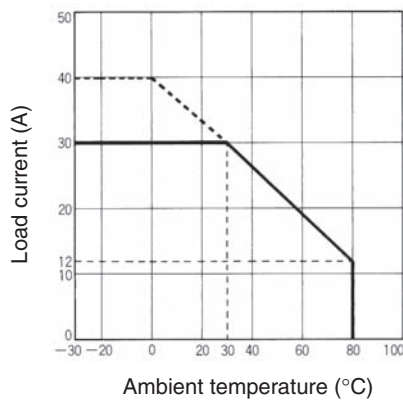

G3PA-450B-VD-2

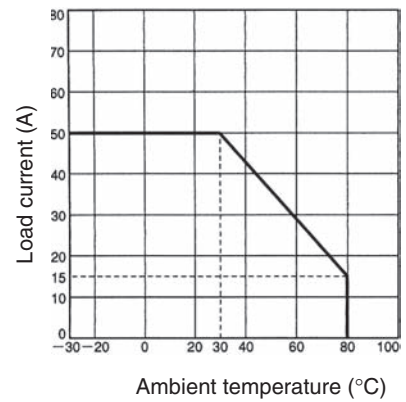

For close mounting of two or three SSRs, limit the load current to 80% or less.

Input Voltage vs. Input Current

G3PA-2□0B-VD(-X)

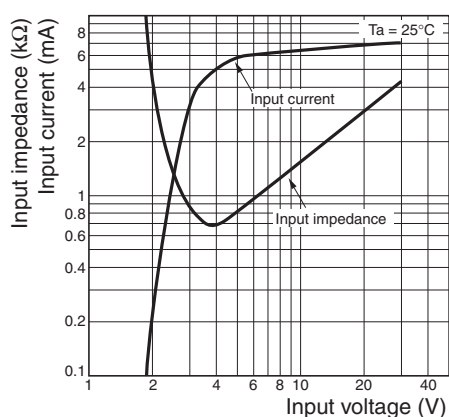

G3PA-4□0-VD, G3PA-4□-VD-2

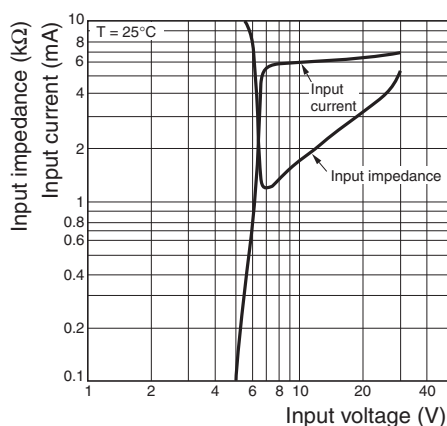

Horizontal Mounting

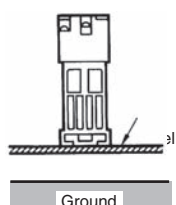

G3PA-210B(L)-VD(-X),
G3PA-220B(L)-VD(-X)

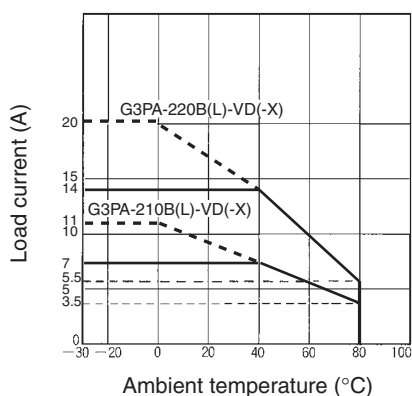

G3PA-240B(L)-VD

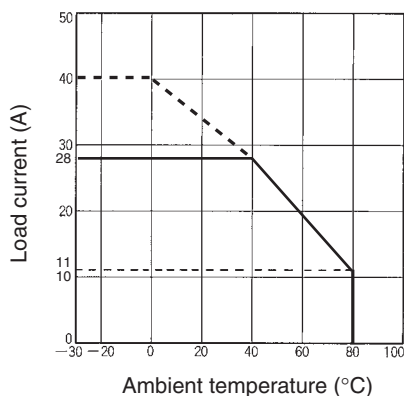

G3PA-260B(L)-VD

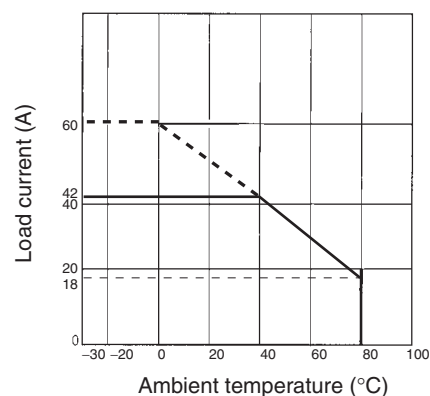

G3PA-420B-VD, G3PA-430B-VD
G3PA-420B-VD-2, G3PA-430B-VD-2

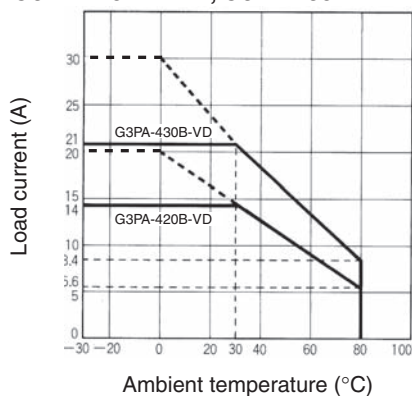

G3PA-450B-VD-2

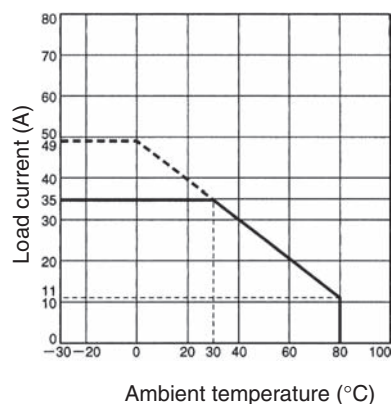

Close Mounting (Up to Three)

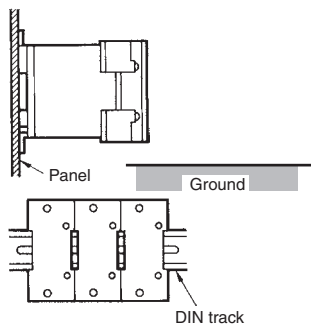

**G3PA-210B(L)-VD(-X),
G3PA-220B(L)-VD(-X)**

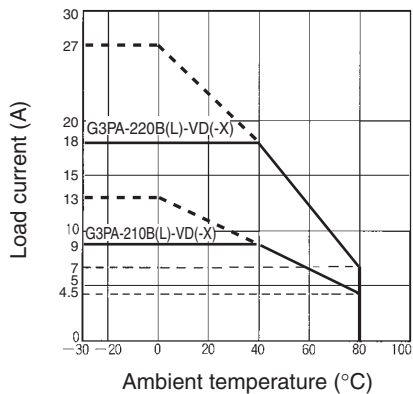

G3PA-240B(L)-VD

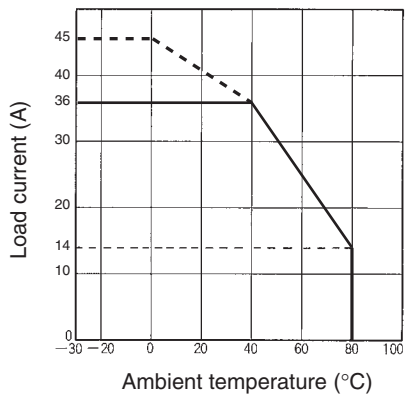

G3PA-260B(L)-VD

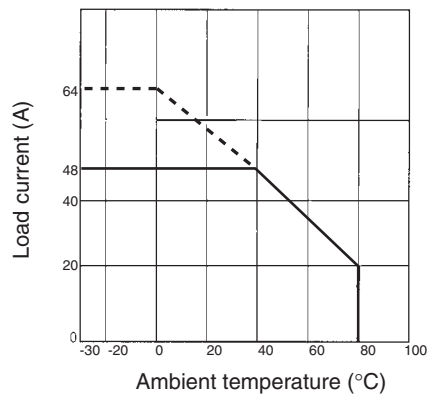

G3PA-420B-VD, G3PA-420B-VD-2

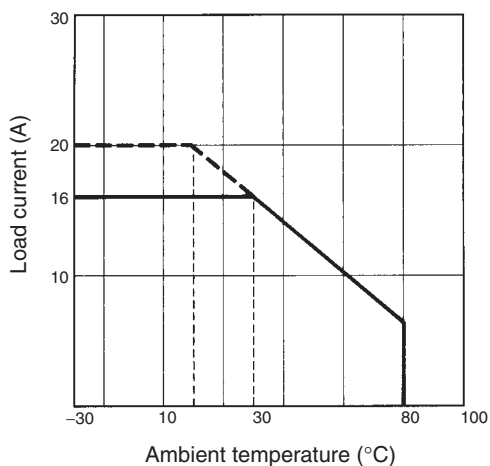

G3PA-430B-VD, G3PA-430B-VD-2

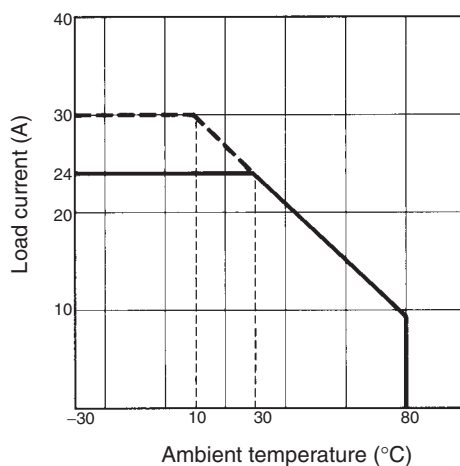

G3PA-450B-VD-2

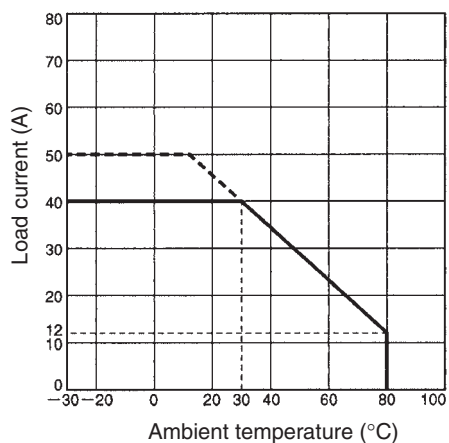

One Cycle Surge Current: Non-repetitive

Note: Keep the inrush current to half the rated value if it occurs repetitively.

G3PA-210B(L)-VD(-X)

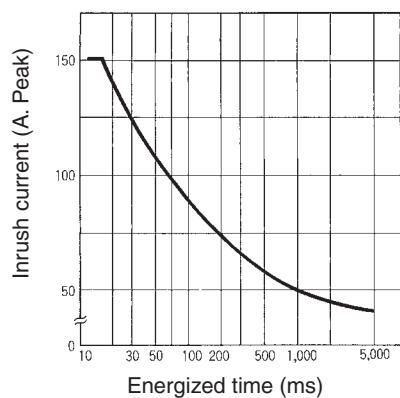

G3PA-220B(L)-VD(-X),
G3PA-420B-VD, G3PA-420B-VD-2

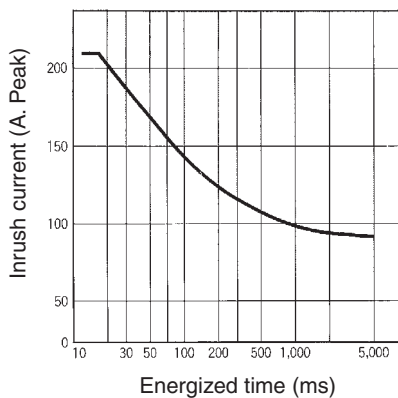

G3PA-240B(L)-VD/260B(L)-VD,
G3PA-430B-VD, G3PA-430B-VD-2,
G3PA-450B-VD-2

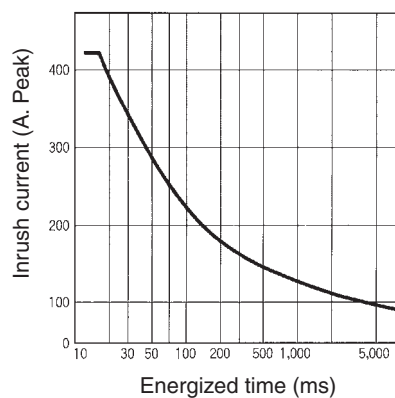

Dimensions

Note: All units are in millimeters unless otherwise indicated.

G3PA-210B(L)-VD(-X)

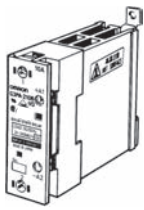

Without Terminal Cover

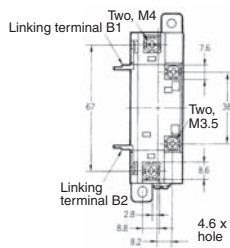

With Terminal Cover

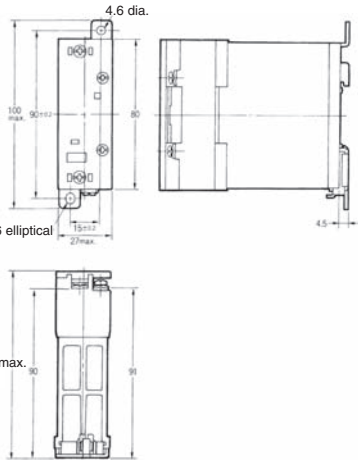

Mounting Holes

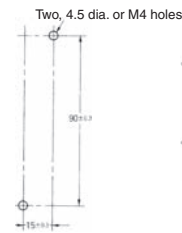

Terminal Arrangement/ Internal Connection:

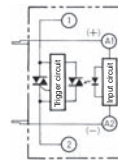

G3PA-220B(L)-VD(-X)

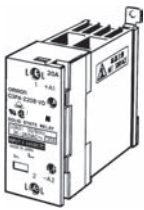

Without Terminal Cover

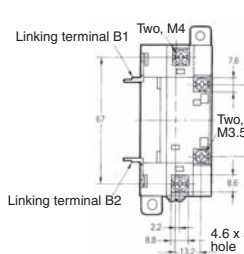

With Terminal Cover

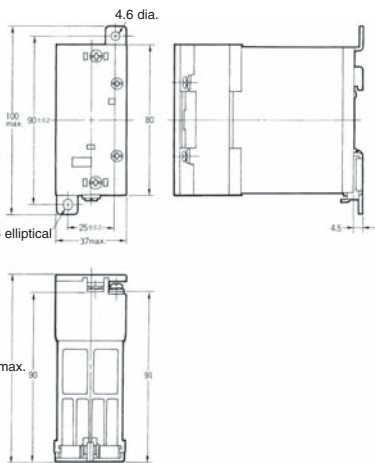

Mounting Holes

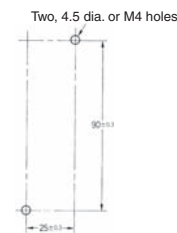

Terminal Arrangement/ Internal Connection:

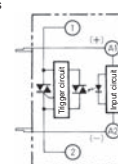

G3PA-240B(L)-VD

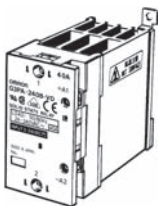

Without Terminal Cover

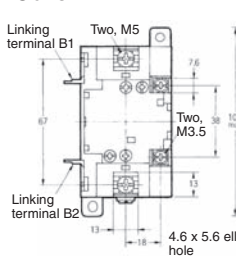

With Terminal Cover

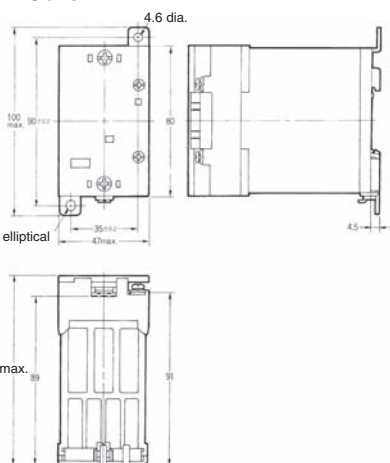

Mounting Holes

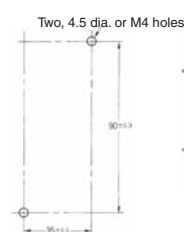

Terminal Arrangement/ Internal Connections

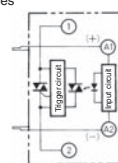

G3PA-260B(L)-VD G3PA-450B-VD-2



With Terminal Cover

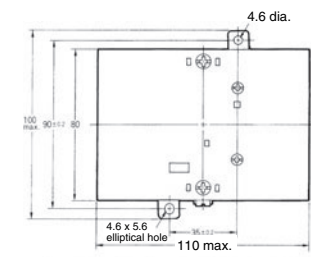

Without Terminal Cover

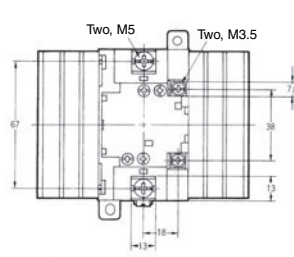

Mounting Holes



**Terminal Arrangement/
Internal Connections**

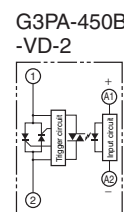
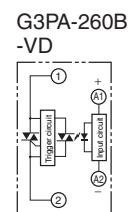

G3PA-420B-VD, G3PA-420B-VD-2

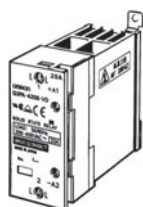

Without Terminal Cover

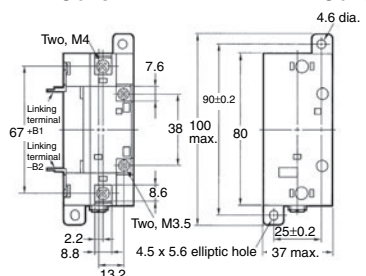

With Terminal Cover

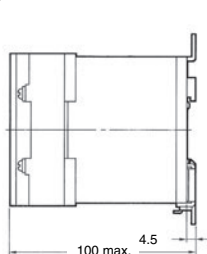

Mounting Holes

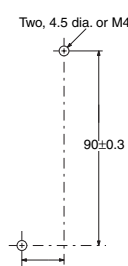

**Terminal Arrangement/
Internal Connections**

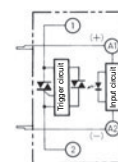

G3PA-430B-VD, G3PA-430B-VD-2

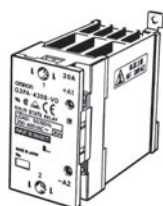

Without Terminal Cover

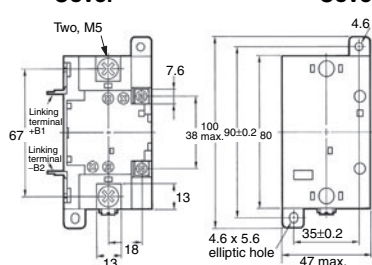

With Terminal Cover

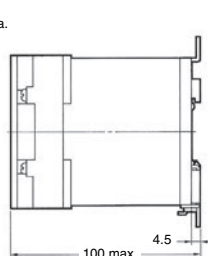

Mounting Holes

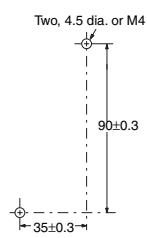

**Terminal Arrangement/
Internal Connections**

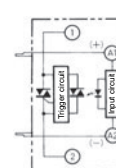

Safety Precautions

■ Precautions for Correct Use

Please observe the following precautions to prevent failure to operate, malfunction, or undesirable effect on product performance.

Load Connection

For an AC load, use a power supply rated at 50 or 60 Hz. The maximum operating frequency is 10 Hz. The G3PA-(VD) has a built-in varistor for overvoltage protection.

At a low applied voltage, such as 24 VAC, the load current is not fully supplied. When the Unit is switched ON, the voltage required to power the Unit deprives the output signal of the necessary voltage level and thus creates loss time. The lower the load voltage is, the greater the loss time is. This condition, however, will not create any serious problems.

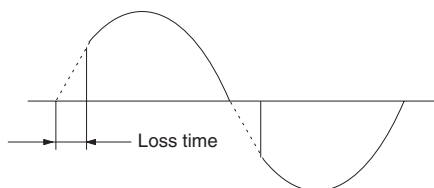

For a DC or L load, a diode should be connected in parallel the load to absorb the counter electromotive force of the load.

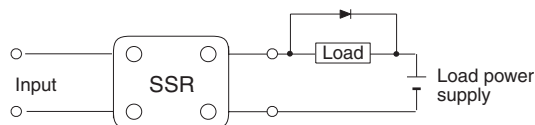

When attaching a heat sink to the G3PA-(VD), in order to facilitate heat dissipation, apply silicone grease or equivalent heat-conductive grease on the heat sink. (Toshiba Silicone, Shinetsu Silicone, etc.)

Tighten the mounting screws of the heat sink with a torque of 0.78 to 0.98 N·m.

Noise Terminal Voltage according to EN55011

The G3PA-(VD) complies with EN55011 standards when a capacitor is connected to the load power supply as shown in the following circuit diagram.

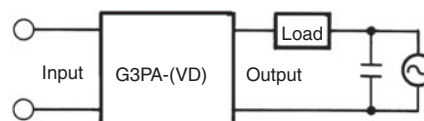

Recommended Capacitor: 1 μ F, 250 VAC

Mounting

The rated ambient temperature is 40°C. (30°C for 400 V.)

Vertical mounting

Close mounting

Horizontal mounting

- Screw or DIN track mounting is possible.
- Vertical mounting should usually be used.

- Close mounting cannot be used if the SSR is used at a 100% load current. Leave a gap of at least 10 mm on the left and right of each Unit.
- Close mounting can be used under the following conditions:
 1. Close mounting can be performed with no more than three SSRs (For four or more SSRs, leave a gap of at least 10 mm.)
 2. Use a load current of 80% or less (90% or less for the G3PA-210B-VD, G3PA-220B-VD, or G3PA-240B-VD).
 3. Leave a gap of at least 80 mm above and below the SSR.
 4. Leave a gap of at least 60 mm from wiring ducts to the top of the SSR and at least 30 mm from wiring ducts to the bottom of the SSR.

- With vertical mounting, reduce the load current by 30%. (Refer to the Load Current vs. Ambient Temperature graph.)

Note: Leave a distance of 60 mm min. between SSRs and ducts (especially above the SSR).

Close Mounting

SSR Mounting Pitch

Panel Mounting (At a rated ambient temperature of 40°C).

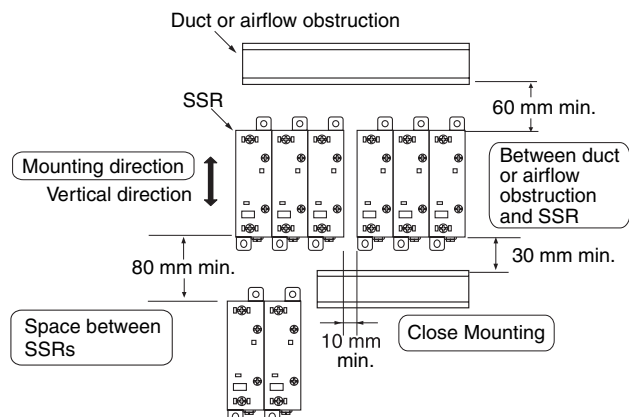

A heat exchanger, if used, should be located in front of the SSR Units to ensure the efficiency of the heat exchanger.

Please reduce the ambient temperature of SSRs.

The rated load current of an SSR is measured at an ambient temperature of 25 or 40 °C.

An SSR uses a semiconductor in the output element. This causes the temperature inside the control panel to increase due to heating resulting from the passage of electrical current through the load. To restrict heating, attach a fan to the ventilation outlet or air inlet of the control panel to ventilate the panel. This will reduce the ambient temperature of the SSRs and thus increase reliability. (Generally, each 10°C reduction in temperature will double the expected life.)

Load current (A)	10 A	20 A	30 A	40 A	60 A
Required number of fans per SSR	0.16	0.31	0.47	0.62	0.93

Example: For 10 SSRs with load currents of 20 A,
 $0.31 \times 10 = 3.1$
 Thus, 4 fans would be required.

Size of fans: 92 mm², Air volume: 0.7 m³/min,
 Ambient temperature of control panel: 30°C

Relationship between SSRs and Ducts

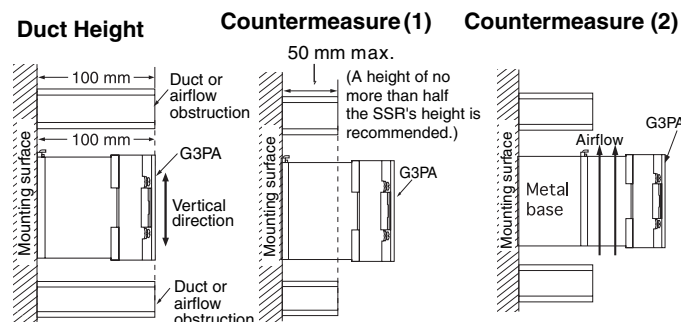

Do not surround the SSR with ducts, otherwise the heat radiation of the SSR will be adversely affected.

Use short ducts.

If the ducts cannot be shortened, place the SSR on a metal base so that it is not surrounded by the ducts.

If there are other instruments that generate heat in the control panel other than SSRs, additional ventilation will be required.

Ventilation

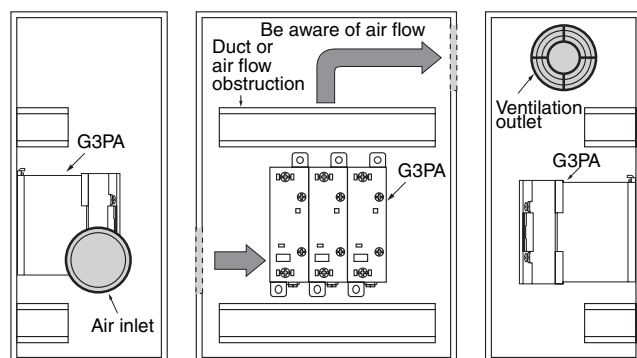

If the air inlet or air outlet has a filter, clean the filter regularly to prevent it from clogging and ensure an efficient flow of air.

Do not locate any objects around the air inlet or air outlet, otherwise the objects may obstruct the proper ventilation of the control panel.

ALL DIMENSIONS SHOWN ARE IN MILLIMETERS.

To convert millimeters into inches, multiply by 0.03937. To convert grams into ounces, multiply by 0.03527.

In the interest of product improvement, specifications are subject to change without notice.

Terms and Conditions Agreement

Read and understand this catalog.

Please read and understand this catalog before purchasing the products. Please consult your OMRON representative if you have any questions or comments.

Warranties.

(a) Exclusive Warranty. Omron's exclusive warranty is that the Products will be free from defects in materials and workmanship for a period of twelve months from the date of sale by Omron (or such other period expressed in writing by Omron). Omron disclaims all other warranties, express or implied.

(b) Limitations. OMRON MAKES NO WARRANTY OR REPRESENTATION, EXPRESS OR IMPLIED, ABOUT NON-INFRINGEMENT, MERCHANTABILITY OR FITNESS FOR A PARTICULAR PURPOSE OF THE PRODUCTS. BUYER ACKNOWLEDGES THAT IT ALONE HAS DETERMINED THAT THE PRODUCTS WILL SUITABLY MEET THE REQUIREMENTS OF THEIR INTENDED USE.

Omron further disclaims all warranties and responsibility of any type for claims or expenses based on infringement by the Products or otherwise of any intellectual property right. (c) Buyer Remedy. Omron's sole obligation hereunder shall be, at Omron's election, to (i) replace (in the form originally shipped with Buyer responsible for labor charges for removal or replacement thereof) the non-complying Product, (ii) repair the non-complying Product, or (iii) repay or credit Buyer an amount equal to the purchase price of the non-complying Product; provided that in no event shall Omron be responsible for warranty, repair, indemnity or any other claims or expenses regarding the Products unless Omron's analysis confirms that the Products were properly handled, stored, installed and maintained and not subject to contamination, abuse, misuse or inappropriate modification. Return of any Products by Buyer must be approved in writing by Omron before shipment. Omron Companies shall not be liable for the suitability or unsuitability or the results from the use of Products in combination with any electrical or electronic components, circuits, system assemblies or any other materials or substances or environments. Any advice, recommendations or information given orally or in writing, are not to be construed as an amendment or addition to the above warranty.

See <http://www.omron.com/global/> or contact your Omron representative for published information.

Limitation on Liability: Etc.

OMRON COMPANIES SHALL NOT BE LIABLE FOR SPECIAL, INDIRECT, INCIDENTAL, OR CONSEQUENTIAL DAMAGES, LOSS OF PROFITS OR PRODUCTION OR COMMERCIAL LOSS IN ANY WAY CONNECTED WITH THE PRODUCTS, WHETHER SUCH CLAIM IS BASED IN CONTRACT, WARRANTY, NEGLIGENCE OR STRICT LIABILITY.

Further, in no event shall liability of Omron Companies exceed the individual price of the Product on which liability is asserted.

Suitability of Use.

Omron Companies shall not be responsible for conformity with any standards, codes or regulations which apply to the combination of the Product in the Buyer's application or use of the Product. At Buyer's request, Omron will provide applicable third party certification documents identifying ratings and limitations of use which apply to the Product. This information by itself is not sufficient for a complete determination of the suitability of the Product in combination with the end product, machine, system, or other application or use. Buyer shall be solely responsible for determining appropriateness of the particular Product with respect to Buyer's application, product or system. Buyer shall take application responsibility in all cases.

NEVER USE THE PRODUCT FOR AN APPLICATION INVOLVING SERIOUS RISK TO LIFE OR PROPERTY OR IN LARGE QUANTITIES WITHOUT ENSURING THAT THE SYSTEM AS A WHOLE HAS BEEN DESIGNED TO ADDRESS THE RISKS, AND THAT THE OMRON PRODUCT(S) IS PROPERLY RATED AND INSTALLED FOR THE INTENDED USE WITHIN THE OVERALL EQUIPMENT OR SYSTEM.

Programmable Products.

Omron Companies shall not be responsible for the user's programming of a programmable Product, or any consequence thereof.

Performance Data.

Data presented in Omron Company websites, catalogs and other materials is provided as a guide for the user in determining suitability and does not constitute a warranty. It may represent the result of Omron's test conditions, and the user must correlate it to actual application requirements. Actual performance is subject to the Omron's Warranty and Limitations of Liability.

Change in Specifications.

Product specifications and accessories may be changed at any time based on improvements and other reasons. It is our practice to change part numbers when published ratings or features are changed, or when significant construction changes are made. However, some specifications of the Product may be changed without any notice. When in doubt, special part numbers may be assigned to fix or establish key specifications for your application. Please consult with your Omron's representative at any time to confirm actual specifications of purchased Product.

Errors and Omissions.

Information presented by Omron Companies has been checked and is believed to be accurate; however, no responsibility is assumed for clerical, typographical or proofreading errors or omissions.