

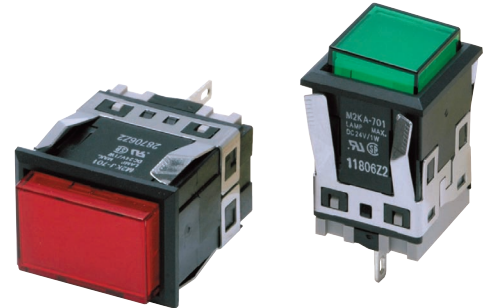

## Miniature Design Achieved with Body Length of 23 mm

- Five colors (red, yellow, green, white, and blue) with LED.
- Chip LED produces even surface brightness.
- Easy panel mounting from the front.



 Refer to *Safety Precautions for All Pushbutton Switches/Indicators* and *Safety Precautions for the A3K*.

## List of Models

### Indicators

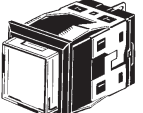
Appearance	Model
Rectangular 	M2KJ
Square 	M2KA

■ Specifications: Refer to page 6.  
■ Accessories: Refer to the A3K.

■ Dimensions: Refer to page 8.

## Model Number Structure

**Model Number Legend** ..... The model numbers used to order sets of Units are illustrated below. One set comprises the Display (LED built in) and Socket Unit. For information on combinations, refer to *Ordering Information* on page 3.

(2) (3) (4)  
**1 - 24E R** ..... Single screen  
 Upper Lower  
**M 2 K J - 9 0 A 2 - 24E RG** ..... Horizontal 2-split screen  
 R (Red) Upper  
 W (White) Lower

**(1) Shape of Display**

Symbol	Shape
J	Rectangular
A	Square

**(2) Screen Pattern**  
Illumination-only models

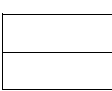
Symbol	Screen pattern
1	Single screen 
2	Horizontal 2-split screen  (rectangular models only)

The screen patterns listed below can be ordered individually. Refer to page 5 for details.

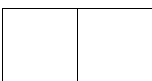
(Vertical 2-split screen)  
  
(rectangular models only)

**(3) Lighting Method**

Symbol	Rated voltage
05E	5 VDC
12E	12 VDC
24E	24 VDC

• Only for LED models.

**(4) Color of Display**

Symbol	Color
R	Red
Y	Yellow
G	Green
W	White
A	Blue
K	Two-color lighting (red/green) (rectangular models only)

► Red/green 2-color lighting:

Unlit	Lit
White	Red
	↑ ↓
	Green

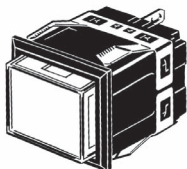
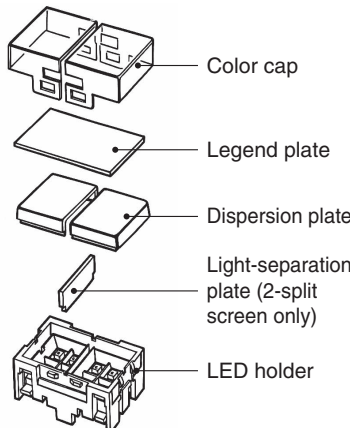
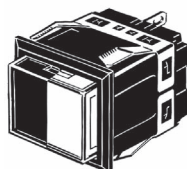
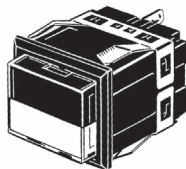
Type	Structure of Split-screen Display
 Single screen (Rectangular models and square models)	(Example: vertical 2-split screen)   <ul style="list-style-type: none"> <li>Color cap</li> <li>Legend plate</li> <li>Dispersion plate</li> <li>Light-separation plate (2-split screen only)</li> <li>LED holder</li> </ul>
 Vertical 2-split screen (See note 3.) (Rectangular models only)	
 Horizontal 2-split screen (Rectangular models only)	
<p>Note: 1. A legend plate and LED (with current-limiting resistor) are built into a standard Display.                      2. Split-screen color configurations are given with the OMRON mark on the Switch facing down.                      3. Vertical 2-split screen models can be ordered only individually. Refer to page 5.                      4. The built-in legend plate is milk-white in color.</p>	

## Ordering Information

**Ordering as a Set** ..... Sets are available that combine an Display (LED built in) and a Socket Unit.

### Indicators

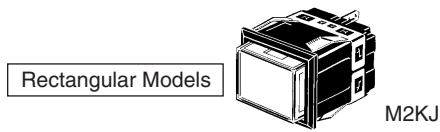

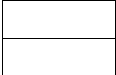
Screen pattern	Operating voltage	Indicator	Operation Unit color symbol		
Single screen 	5 VDC	<b>M2KJ-90A1-05E</b> <sup>1</sup>	Insert a color symbol in the box with the one at the end of the model number. R (red)    W (white) Y (yellow) A (blue) G (green) K (red/green)		
	12 VDC	<b>M2KJ-90A1-12E</b> <sup>1</sup>			
	24 VDC	<b>M2KJ-90A1-24E</b> <sup>1</sup>			
Horizontal 2-split screen 	24 VDC	<b>M2KJ-90A2-24E</b> <sup>1</sup> <sup>2</sup>	Insert a color symbol in the boxes with the one and two at the end of the model number. R (red) Y (yellow) G (green) W (white) A (blue) <table border="1" style="display: inline-table; vertical-align: middle;"> <tr><td>1</td></tr> <tr><td>2</td></tr> </table>	1	2
1					
2					



Screen pattern	Operating voltage	Indicator	Operation Unit color symbol
Single screen 	5 VDC	<b>M2KA-90A1-05E</b> <sup>1</sup>	Insert a color symbol in the box with the one at the end of the model number. R (red) Y (yellow) G (green) W (white) A (blue)
	12 VDC	<b>M2KA-90A1-12E</b> <sup>1</sup>	
	24 VDC	<b>M2KA-90A1-24E</b> <sup>1</sup>	

Individual models: Refer to pages 4 to 5.  
(The Light and Switch can be ordered separately.)

■ Specifications: Refer to page 6. ■ Dimensions: Refer to page 8.  
■ Accessories: Refer to the A3K.

## Ordering Information

**Ordering Individually** ..... Displays (LED built in), and Socket Units can be ordered separately. Combinations that are not available as sets can be created using individual Units. Also, store the parts as spares for maintenance and repairs.

**Ordering** ..... Specify a model on the following page.

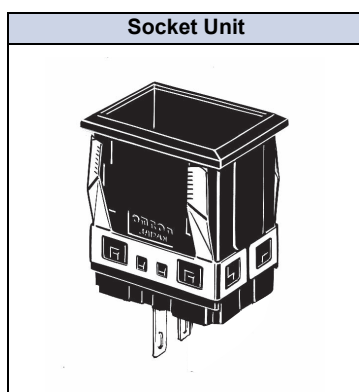
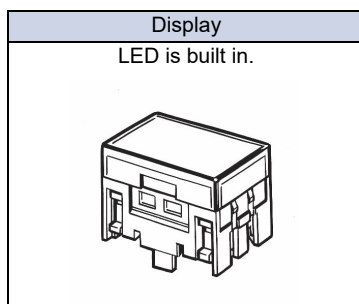

Ordering set combinations: Refer to page 3.









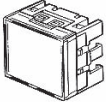

■ Specifications: Refer to page 6. ■ Dimensions: Refer to page 8.  
■ Accessories: Refer to the A3K.

## Ordering Information

### Display

#### LED-lighted Models (LED chip built in)

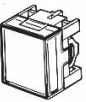
Not all combinations are possible. Ask your OMRON representative for details.

Appearance	Screen pattern	Color	White (W)	Red (R)	Green (G)	Blue (A)	Yellow (Y)	Selection precautions
Rectangular Models (M2KJ) 	Single screen		M2KJ -51W-□□E	M2KJ -51R-□□E	M2KJ -51G-□□E	---	M2KJ -51Y-□□E	<ul style="list-style-type: none"> <li>Enter the voltage to be used in the □□ at the end of the model number. Examples of voltage used: 5 V = 05E 12 V = 12E 24 V = 24E</li> <li>Two-split screen models support only 24 V.</li> <li>For the color of the shaded part, select the model according to the colors given at the top of the table.</li> </ul>
	Horizontal 2-split screen		M2KJ -52WW-□□E	M2KJ -52WR-□□E	---	M2KJ -52WA-□□E	---	
			M2KJ -52RW-□□E	M2KJ -52RR-□□E	M2KJ -52RG-□□E	---	M2KJ -52RY-□□E	
			---	M2KJ -52GR-□□E	---	M2KJ -52GA-□□E	M2KJ -52GY-□□E	
	Vertical 2-split screen		M2KJ -53WW-□□E	---	M2KJ -53WG-□□E	---	---	
			---	M2KJ -53RR-□□E	M2KJ -53RG-□□E	---	---	
			---	M2KJ -53GR-□□E	---	---	M2KJ -53GY-□□E	
Two-color full illumination (red/green)		M2KJ-57K-□□E						
Square Models (M2KA) 	Single screen		M2KA -51W-□□E	M2KA -51R-□□E	M2KA -51G-□□E	M2KA -51A-□□E	M2KA -51Y-□□E	

- Note: 1. A legend plate and LED (with current-limiting resistor) are built into a standard Display.  
 2. Split-screen coloring configurations are given with the OMRON mark on the Sockets facing down.  
 3. The built-in legend plate is milk-white in color.

### Socket Unit

Appearance	Rectangular models	Square models	Remarks
Model	M2KJ-7010	M2KA-7010	Refer to the A3K datasheet for mounting and removing.

Ordering set combinations: Refer to page 3.

- Specifications: Refer to page 6. ■ Dimensions: Refer to page 8.
- Accessories: Refer to the A3K.

## Ordering Information

### Accessories, Replacements, and Tools

Refer to the A3K datasheet.

## Specifications

### Approved Standard Ratings

UL (File No. E41515), CSA (File No. LR45258)

LED: 24 VDC, 1 W max.

Note: Certification has been obtained for the indicator.

For detailed information on individual products that have received certification, consult your supplier.

### Ratings

#### LED Ratings

##### Rectangular Models (M2KJ)

Applicable voltage	Rated voltage	Rated current
5 VDC $\pm$ 5%	5 VDC	48 mA (18 mA) *
12 VDC $\pm$ 5%	12 VDC	20 mA (10 mA) *
24 VDC $\pm$ 5%	24 VDC	10 mA (5 mA) *

\* Values are for blue illumination.

##### Square Models (M2KA)

Applicable voltage	Rated voltage	Rated current
5 VDC $\pm$ 5%	5 VDC	24 mA (10 mA) *
12 VDC $\pm$ 5%	12 VDC	24 mA (10 mA) *
24 VDC $\pm$ 5%	24 VDC	12 mA (5 mA) *

\* Values are for blue illumination.

<b>Ambient operating temperature</b>	-10 to 50°C (with no icing or condensation)
<b>Ambient operating humidity</b>	35% to 85%RH
<b>Ambient storage temperature</b>	-25 to 65°C (with no icing or condensation)

Nomenclature

Model Structure

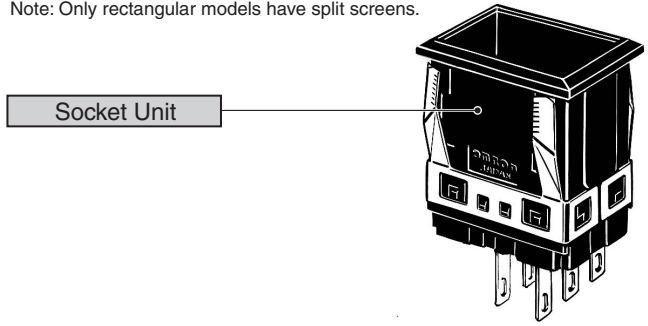
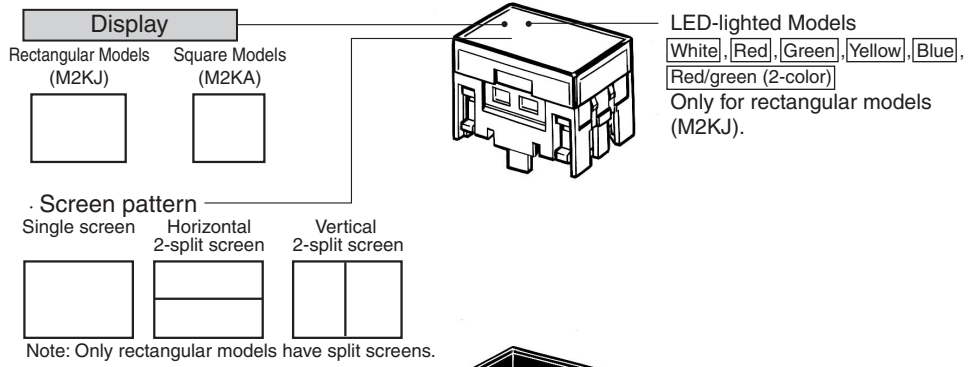
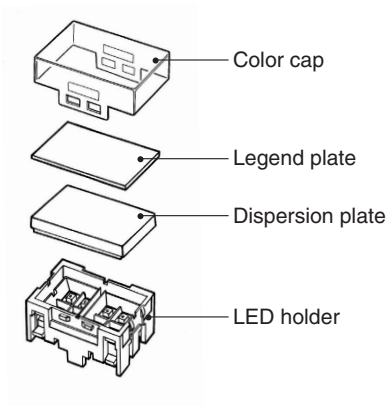

Note: The M2KJ model is shown here as an example.

## Dimensions

### Rectangular Models (M2KJ)

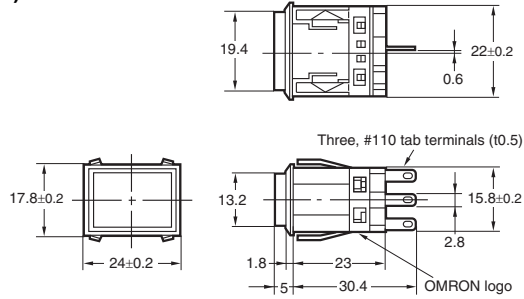
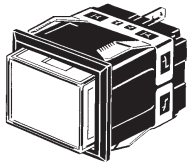

Note: Unless specified, a tolerance of  $\pm 0.4$  mm applies for all dimensions. Use a mounting panel thickness of 1 to 4 mm.

### Square Models (M2KA)

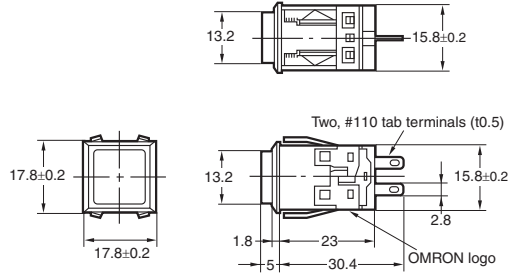
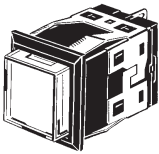

## Terminal Arrangement

Bottom View (All are shown with the OMRON logo facing down.)

Rectangular Models (M2KJ)	Square Models (M2KA)



Dimensions

Terminal Connections  
LED-lighted Models

(All are shown with the OMRON logo facing down.)

Operating voltage		5 VDC		12 VDC		24 VDC	
Model	Screen pattern						
M2KJ	Single screen	Bottom View 	Top View 	Bottom View 	Top View 	Bottom View 	Top View 
	Horizontal 2-split screen	Bottom View 	Top View 	Bottom View 	Top View 	Bottom View 	Top View 
	Vertical 2-split screen	Bottom View 	Top View 	Bottom View 	Top View 	Bottom View 	Top View 
	Two-color lighting (red/green)	Bottom View 	Top View 	Bottom View 	Top View 	Bottom View 	Top View 
M2KA	Single screen	Bottom View 		Top View 		Bottom View 	
						Top View 	

## Dimensions

(Unit: mm)

### Panel Cutout

(If a Switch Guard or Seal Cover is to be used, refer to the panel cutout diagrams for the A3K.)

### Rectangular Models (M2KJ)

Recommended panel thickness: 1 to 4 mm

Classification	Mounting design	Panel cutout	Remarks
Flange mount models	Individual mounting, horizontal 		<p>Panel cutout spacing between rows of Units:</p>
	Multiple mounting, horizontal 		
	Individual mounting, vertical 		
	Multiple mounting, vertical 		
Barrier mount models	Individual mounting, horizontal 		<p>Panel cutout spacing between rows of Units:</p> <p>(Dotted line indicates the position of each Mounting Barrier.)</p>
	Multiple mounting, horizontal 		
	Individual mounting, vertical 		
	Multiple mounting, vertical 		

• If the panel is to be finished (e.g., coated), make sure that the panel meets the specified dimensions after the coating.

### Square Models (M2KA)

Recommended panel thickness: 1 to 4 mm

Classification	Mounting design	Panel cutout	Remarks
Flange mount models	Individual mounting 		<p>Panel cutout spacing between rows of Units:</p>
	Multiple mounting 		
Barrier mount models	Individual mounting 		<p>Panel cutout spacing between rows of Units:</p> <p>(Dotted line indicates the position of each Mounting Barrier.)</p>
	Multiple mounting 		

• If the panel is to be finished (e.g., coated), make sure that the panel meets the specified dimensions after the coating.

## Safety Precautions

---

Refer to *Safety Precautions for All Pushbutton Switches/Indicators* and *Safety Precautions for the A3K*.

## Terms and Conditions Agreement

### Read and understand this catalog.

Please read and understand this catalog before purchasing the products. Please consult your OMRON representative if you have any questions or comments.

### Warranties.

(a) Exclusive Warranty. Omron's exclusive warranty is that the Products will be free from defects in materials and workmanship for a period of twelve months from the date of sale by Omron (or such other period expressed in writing by Omron). Omron disclaims all other warranties, express or implied.

(b) Limitations. OMRON MAKES NO WARRANTY OR REPRESENTATION, EXPRESS OR IMPLIED, ABOUT NON-INFRINGEMENT, MERCHANTABILITY OR FITNESS FOR A PARTICULAR PURPOSE OF THE PRODUCTS. BUYER ACKNOWLEDGES THAT IT ALONE HAS DETERMINED THAT THE PRODUCTS WILL SUITABLY MEET THE REQUIREMENTS OF THEIR INTENDED USE.

Omron further disclaims all warranties and responsibility of any type for claims or expenses based on infringement by the Products or otherwise of any intellectual property right. (c) Buyer Remedy. Omron's sole obligation hereunder shall be, at Omron's election, to (i) replace (in the form originally shipped with Buyer responsible for labor charges for removal or replacement thereof) the non-complying Product, (ii) repair the non-complying Product, or (iii) repay or credit Buyer an amount equal to the purchase price of the non-complying Product; provided that in no event shall Omron be responsible for warranty, repair, indemnity or any other claims or expenses regarding the Products unless Omron's analysis confirms that the Products were properly handled, stored, installed and maintained and not subject to contamination, abuse, misuse or inappropriate modification. Return of any Products by Buyer must be approved in writing by Omron before shipment. Omron Companies shall not be liable for the suitability or unsuitability or the results from the use of Products in combination with any electrical or electronic components, circuits, system assemblies or any other materials or substances or environments. Any advice, recommendations or information given orally or in writing, are not to be construed as an amendment or addition to the above warranty.

See <http://www.omron.com/global/> or contact your Omron representative for published information.

### Limitation on Liability: Etc.

OMRON COMPANIES SHALL NOT BE LIABLE FOR SPECIAL, INDIRECT, INCIDENTAL, OR CONSEQUENTIAL DAMAGES, LOSS OF PROFITS OR PRODUCTION OR COMMERCIAL LOSS IN ANY WAY CONNECTED WITH THE PRODUCTS, WHETHER SUCH CLAIM IS BASED IN CONTRACT, WARRANTY, NEGLIGENCE OR STRICT LIABILITY.

Further, in no event shall liability of Omron Companies exceed the individual price of the Product on which liability is asserted.

### Suitability of Use.

Omron Companies shall not be responsible for conformity with any standards, codes or regulations which apply to the combination of the Product in the Buyer's application or use of the Product. At Buyer's request, Omron will provide applicable third party certification documents identifying ratings and limitations of use which apply to the Product. This information by itself is not sufficient for a complete determination of the suitability of the Product in combination with the end product, machine, system, or other application or use. Buyer shall be solely responsible for determining appropriateness of the particular Product with respect to Buyer's application, product or system. Buyer shall take application responsibility in all cases.

NEVER USE THE PRODUCT FOR AN APPLICATION INVOLVING SERIOUS RISK TO LIFE OR PROPERTY OR IN LARGE QUANTITIES WITHOUT ENSURING THAT THE SYSTEM AS A WHOLE HAS BEEN DESIGNED TO ADDRESS THE RISKS, AND THAT THE OMRON PRODUCT(S) IS PROPERLY RATED AND INSTALLED FOR THE INTENDED USE WITHIN THE OVERALL EQUIPMENT OR SYSTEM.

### Programmable Products.

Omron Companies shall not be responsible for the user's programming of a programmable Product, or any consequence thereof.

### Performance Data.

Data presented in Omron Company websites, catalogs and other materials is provided as a guide for the user in determining suitability and does not constitute a warranty. It may represent the result of Omron's test conditions, and the user must correlate it to actual application requirements. Actual performance is subject to the Omron's Warranty and Limitations of Liability.

### Change in Specifications.

Product specifications and accessories may be changed at any time based on improvements and other reasons. It is our practice to change part numbers when published ratings or features are changed, or when significant construction changes are made. However, some specifications of the Product may be changed without any notice. When in doubt, special part numbers may be assigned to fix or establish key specifications for your application. Please consult with your Omron's representative at any time to confirm actual specifications of purchased Product.

### Errors and Omissions.

Information presented by Omron Companies has been checked and is believed to be accurate; however, no responsibility is assumed for clerical, typographical or proofreading errors or omissions.