

Ultra-Compact Interface Wiring System XW2K

The Industry's Smallest*1 Compact Interface Wiring System to Reduce Work and Save Space on Control Panels

- This product is the industry's smallest*1 and is mountable in two ways (vertical and horizontal), so you can use space efficiently to downsize and save space on your control panels.
- Push-In Plus terminal blocks are employed to reduce wiring work by 60%*2 compared with traditional screw terminal blocks. No loosening of screws means maintenance-free operation.
- Wiring patterns specifically designed for connections with the PLCs of each company reduce the work required for signal layout checking.
- Two types are available to choose from to suit the relay method of the I/O line.
(Connection example 1: Interface wiring system, connection example 2: Interface wiring system (integrated common terminal type))



*1. Results of OMRON survey conducted in March, 2022
*2. OMRON's actual measurement value data

Selection Guide

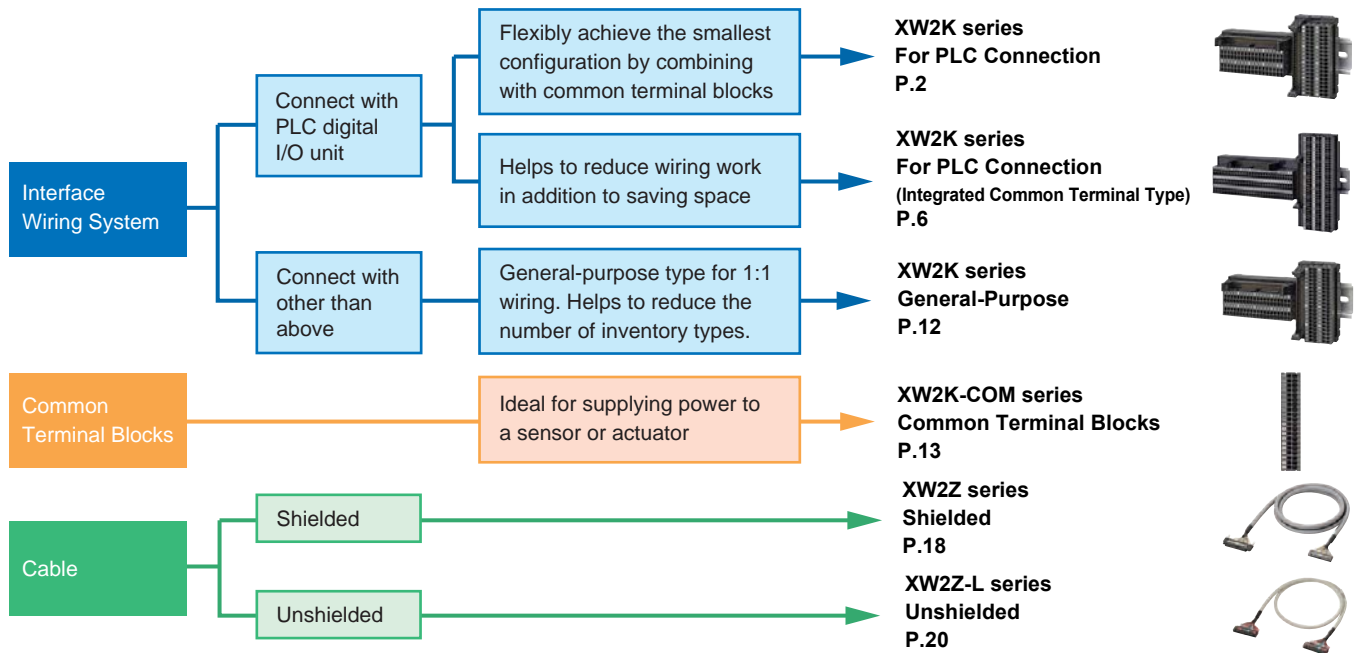

Connection Examples

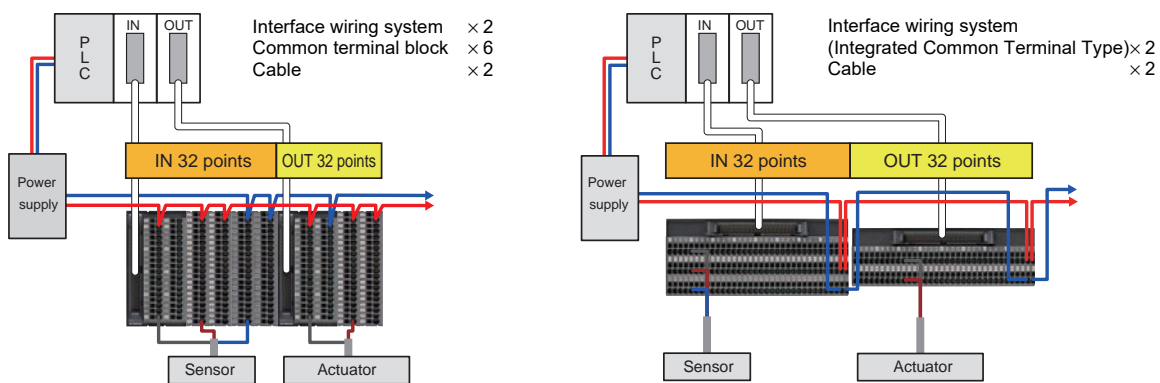

XW2K

Ultra-Compact Interface Wiring System

XW2K

For PLC Connection



Model Number Structure

Model Number Legend

XW2K- **G**- **32**

Series name (1) (2) (3) (4) (5)

(1) Number of Connector poles

34: 34 poles
40: 40 poles

(3) PLC manufacturer

O: OMRON, Yokogawa Electric, Hitachi Industrial Equipment Systems
M: Mitsubishi Electric, Fuji Electric
K: KEYENCE

(4) I/O Points

32: 32 Points

(5) Wiring pattern

A:
B:
C:
Blank:

Note:
Refer to the following PLC compatibility table.

PLC Compatibility Table

PLC					Quantity required	Interface Wiring System Blue text: For PLC Black text: 1:1 wiring	Cable		
Manufacturer name	Series name	I/O	Unit model	I/O Points			Shielded	Unshielded	
OMRON	CS	Input	CS1W-ID231	32	1	XW2K-40G-O32A	XW2Z-100B	XW2Z-0100BF-L	
			CS1W-ID261	64	2				
		Output	CS1W-OD231, CS1W-OD232	32	1				XW2K-40G-O32B
			CS1W-OD261, CS1W-OD262	64	2				
		Mixed I/O (input side)	CS1W-MD261, CS1W-MD262	32	1				XW2K-40G-O32A
			CS1W-MD561	32	1				
		Mixed I/O (output side)	CS1W-MD261, CS1W-MD262	32	1				XW2K-40G-O32B
		CS1W-MD561	32	1					
	CJ	Input	CJ1W-ID231	32	1	XW2K-40G-O32A	XW2Z-100B	XW2Z-0100BF-L	
			CJ1W-ID261	64	2	XW2K-40G-O32A	XW2Z-100K	XW2Z-0100FF-L	
			CJ1W-ID232, CJ1W-ID233	32	1	XW2K-40G-O32C	XW2Z-100B	XW2Z-0100BF-L	
			CJ1W-ID262	64	2	XW2K-40G-O32B	XW2Z-100K	XW2Z-0100FF-L	
		Output	CJ1W-OD231	32	1	XW2K-40G-O32B	XW2Z-100B	XW2Z-0100BF-L	
			CJ1W-OD261	64	2	XW2K-40G-O32B	XW2Z-100K	XW2Z-0100FF-L	
			CJ1W-OD232, CJ1W-OD233	32	1	XW2K-40G-O32C	XW2Z-100A	XW2Z-0100AD-L	
			CJ1W-OD262, CJ1W-OD263	64	2	XW2K-40G-O32C	XW2Z-100X	XW2Z-0100DD-L	
		Mixed I/O (input side)	CJ1W-MD231	16	1	XW2K-20G-T *1	XW2Z-100X	XW2Z-0100DD-L	
			CJ1W-MD232	16	1		XW2Z-100X	XW2Z-0100DD-L	
			CJ1W-MD233	16	1		XW2Z-100B	XW2Z-0100BF-L	
			CJ1W-MD261	32	1		XW2K-40G-O32A	XW2Z-100K	XW2Z-0100FF-L
		Mixed I/O (output side)	CJ1W-MD263, CJ1W-MD563	32	1	XW2K-40G-O32C	XW2Z-100A	XW2Z-0100AD-L	
			CJ1W-MD231	16	1	XW2K-20G-T *1	XW2Z-100X	XW2Z-0100DD-L	
			CJ1W-MD232	16	1		XW2Z-100X	XW2Z-0100DD-L	
			CJ1W-MD233	16	1		XW2Z-100X	XW2Z-0100DD-L	
	CJ1W-MD261	32	1	XW2K-40G-O32B	XW2Z-100B		XW2Z-0100BF-L		
	NX	Input	CJ1W-MD263, CJ1W-MD563	32	1	XW2K-40G-O32C	XW2Z-100K	XW2Z-0100FF-L	
			NX-ID5142-5	16	1	XW2K-20G-T *1	XW2Z-100X	XW2Z-0100DD-L	
			NX-ID6142-5	32	1	XW2K-40G-O32C	XW2Z-100K	XW2Z-0100FF-L	
Output		NX-ID6142-6	32	1	XW2K-40G-O32A	XW2Z-100B	XW2Z-0100BF-L		
		NX-OD5121-5, NX-OD5256-5	16	1	XW2K-20G-T *1	XW2Z-100X	XW2Z-0100DD-L		
		NX-OD6121-5, NX-OD6256-5	32	1	XW2K-40G-O32C	XW2Z-100K	XW2Z-0100FF-L		
Mixed I/O (input side)		NX-OD6121-6	32	1	XW2K-40G-O32B	XW2Z-100B	XW2Z-0100BF-L		
		NX-MD6121-5, NX-MD6256-5	16	1	XW2K-20G-T *1	XW2Z-100X	XW2Z-0100DD-L		
		NX-MD6121-6	16	1		XW2Z-100A	XW2Z-0100AD-L		
NX-MD6121-5, NX-MD6256-5		16	1	XW2Z-100X		XW2Z-0100DD-L			
Mixed I/O (output side)		NX-MD6121-6	16	1	XW2Z-100A	XW2Z-0100AD-L			

PLC					Quantity required	Interface wiring system Blue text: For PLC Black text: 1:1 wiring	Cable			
Manufacturer name	Series name	I/O	Unit model	I/O Points			Shielded	Unshielded		
Yokogawa Electric	FA-M3	Input	F3XD32-3F, F3XD32-4F, F3XD32-5F	32	1	XW2K-40G-O32A	XW2Z-100B	XW2Z-0100BF-L		
			F3XD64-3F, F3XD64-4F	64	2					
		Output	F3YD32-1H, F3YD32-1T F3YD32-1P, F3YD32-1R	32	1				XW2K-40G-O32B	
			F3YD64-1P, F3YD64-1R	64	2					
			Mixed I/O (input side)	F3WD64-3P, F3WD64-4P	32				1	XW2K-40G-O32A
Mixed I/O (output side)	F3WD64-3P, F3WD64-4P	32	1	XW2K-40G-O32B						
Hitachi Industrial Equipment Systems	EH-150/EHV	Input	EH-XD32, EH-XDL32, EH-XDS32, EH-XDB32, EH-XDBL32	32	1	XW2K-40G-O32A	XW2Z-100B	XW2Z-0100BF-L		
			EH-XD64, EH-XDL64 EH-XDB64, EH-XDBL64	64	2					
		Output	EH-YT32, EH-YTP32	32	1				XW2K-40G-O32B	
			EH-YT64, EH-YTP64	64	2					
Mitsubishi Electric	MELSEC L	Input	LX41C4	32	1	XW2K-40G-M32	XW2Z-100B	XW2Z-0100BF-L		
			LX42C4	64	2					
		Output	LY41NT1P, LY41PT1P	32	1					
			LY42NT1P, LY42PT1P	64	2					
			Mixed I/O (input side)	LH42C4NT1P, LH42C4PT1P	32				1	
	Mixed I/O (output side)	LH42C4NT1P, LH42C4PT1P	32	1						
	MELSEC Q	Input	QX41, QX41-S1, QX41-S2, QX71	32	1					
			QX42, QX42-S1, QX72, QX82, QX82-S1	64	2					
		Output	QY41P, QY71	32	1					
			QY42P, QY82P	64	2					
			Mixed I/O (input side)	QH42P, QX41Y41P	32				1	
	Mixed I/O (output side)	QH42P, QX41Y41P	32	1						
	MELSEC iQ-R	Input	RX41C4, RX71C4 RX41C6HS, RX61C6HS	32	1					
			RX42C4, RX72C4	64	2					
		Output	RY41NT2P, RY41NT2H RY41PT1P, RY41PT2H	32	1					
RY42NT2P, RY42PT1P			64	2						
Mixed I/O (input side)			RH42C4NT2P	32	1					
Mixed I/O (output side)	RH42C4NT2P	32	1							
Fuji Electric	MICREX-SX	Input	NP1X3202-W, NP1X3206-W	32	1	XW2K-40G-M32	XW2Z-100B	XW2Z-0100BF-L		
			NP1X6406-W	64	2					
		Output	NP1Y32T09P1, NP1Y32U09P1	32	1					
			NP1Y64T09P1, NP1Y64U09P1	64	2					
			Mixed I/O (input side)	NP1W6406T, NP1W6406U	32				1	
Mixed I/O (output side)	NP1W6406T, NP1W6406U	32	1							
KEYENCE	KV-1000	Input	KV-C32XA	32	1	XW2K-34G-K32	XW2Z-100EE	XW2Z-0100EE-L		
			KV-C64XA	64	2					
		Output	KV-C32TA	32	1					
			KV-C64TA	64	2					
			CPU unit	KV-1000 (CPU)	-				1	XW2K-40G-T *1
	KV-3000 KV-5000 KV-5500 KV-7000 KV-8000	Input	KV-C32XC	32	1	XW2K-34G-K32	XW2Z-100EE	XW2Z-0100EE-L		
			KV-C64XC	64	2					
		Output	KV-C32TC, KV-C32TD, KV-C32TCP	32	1					
			KV-C64TC, KV-C64TD, KV-C64TCP	64	2					
			Mixed I/O	KV-C16XTD	32				1	
		Mixed I/O (input side)	KV-C32XTD	32	1					
		Mixed I/O (output side)	KV-C32XTD	32	1					
	CPU unit	KV-3000 / 5000 / 5500 (CPU)	-	1	XW2K-40G-T *1	XW2Z-100K	XW2Z-0100FF-L			
	KV Nano	Basic unit	KV-SIR32XT	32	1	XW2K-40G-T *1	XW2Z-100K	XW2Z-0100FF-L		
			KV-SIR32XT	32	1					
Input		KV-NC32T	32	1	XW2K-34G-T *1				XW2Z-100EE	XW2Z-0100EE-L
		KV-NC32EX	32	1						
		KV-NC32ET	32	1						
Output		KV-NC16EXT	32	1						
		KV-NC32EXT	32	1						
Mixed I/O (input side)	KV-NC32EXT	32	1							
Mixed I/O (output side)	KV-NC32EXT	32	1							

Note: 1. This PLC compatibility table mainly lists digital I/O units. For units not in the compatibility table, select a general-purpose type for 1:1 wiring (page 12).
 2. The cable model to use is one with a cable length of 1 m. Refer to the section from page 18 for details.
 3. Caution is required when connecting with Yokogawa Electric, Hitachi Industrial Equipment Systems, and Fuji Electric PLCs. The PLC address is in the order of left to right, but the PLC address indication printed on the top surface of the terminal block follows that of the representative manufacturer.
 · For Yokogawa Electric and Hitachi Industrial Equipment Systems PLCs ⇒ Address indication of OMRON PLCs
 · For Fuji Electric PLCs ⇒ Address indication of Mitsubishi Electric PLCs

*1. Refer to page 12 for the model reference.

For PLC Connection

For PLC Connection (Integrated Common Terminal Type)

General-Purpose

Common Terminal Blocks

Common Items for Terminal Blocks

Cable (Shielded)

Cable (Unshielded)

XW2K

For OMRON, Yokogawa Electric, or Hitachi Industrial Equipment Systems PLC Connection

Ordering Information

Appearance	Mounted connector	I/O Points	PWB color	Model	Dimension (mm)
	MIL 40 poles	32	Green	XW2K-40G-032A	When installed vertically: 39 x 75 x 40.8 When installed horizontally: 75 x 39 x 40.8
			Blue	XW2K-40G-032B	
			Black	XW2K-40G-032C	

Ratings

Rated voltage	30 VDC	
Rated current	I/O unit signal line: 0.5 A, I/O unit common line: 4 A, Power supply line: 7 A	
Applicable wire #1	Stranded wire, solid wire	0.08 to 1.5 mm ² (AWG 28 to 16)
	Ferrules	With insulation sleeve: 0.14 to 0.5 mm ² (AWG 26 to 20) Without insulation sleeve: 0.75 to 1.5 mm ² (AWG 18 to 16)

*1. Outer diameter of insulation must be 2.8 mm max.

Refer to page 16 for information on recommended ferrules and crimp tools.

Refer to the common items (page 14) for details on performance.

Wiring Diagram and Dimensions

XW2K-40G-032A

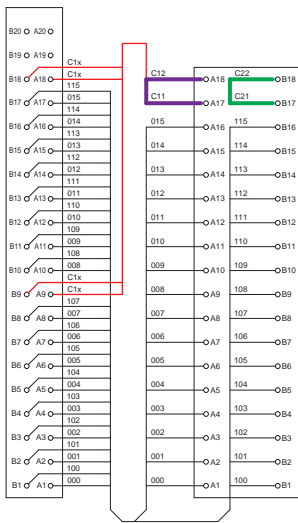

XW2K-40G-032B

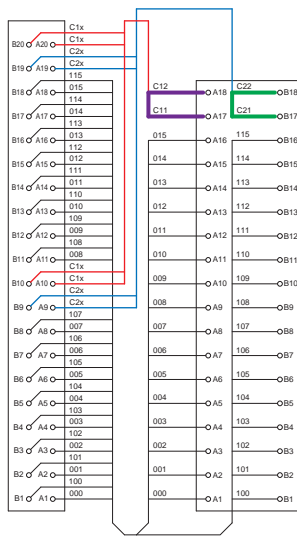

XW2K-40G-032C

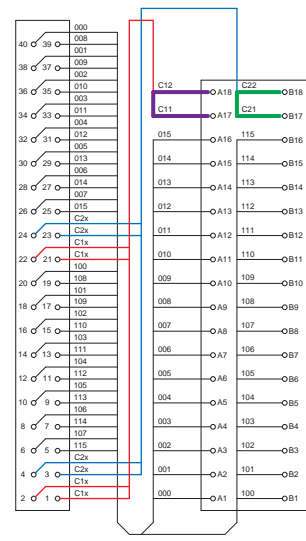

I/O unit signal line (black): 0.5 A, I/O unit common line (red/blue): 4 A, Power supply line (purple/green): 7 A

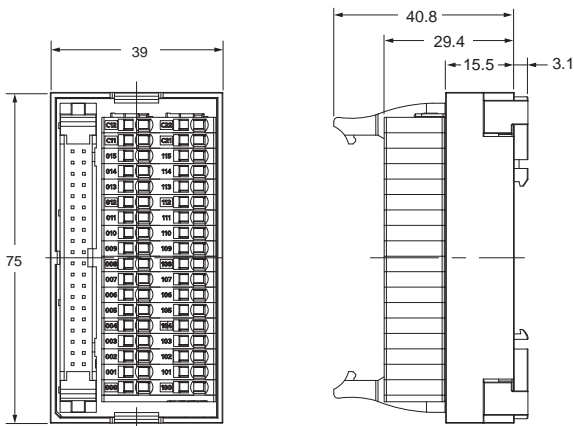

Note: The dimensions diagram is common for all three models.

How to distinguish between the three XW2K-40G-032□ models

The PWB colors are different so you can determine the model from the front without looking at the model indication on the side.

 XW2K-40G-032A
PWB color: green

 XW2K-40G-032B
PWB color: blue

 XW2K-40G-032C
PWB color: black

For Mitsubishi Electric, Fuji Electric, or KEYENCE PLC Connection

Ordering Information

Appearance	Mounted connector	I/O Points	PWB color	Model	Dimension (mm)
	MIL 40 poles	32	Black	XW2K-40G-M32	When installed vertically: 39 x 75 x 40.8 When installed horizontally: 75 x 39 x 40.8
	MIL 34 poles			XW2K-34G-K32	

Ratings

Rated voltage	30 VDC	
Rated current	I/O unit signal line: 0.5 A, I/O unit common line: 1 A/2 A, Power supply line: 7 A	
Applicable wire *1	Stranded wire, solid wire	0.08 to 1.5 mm ² (AWG 28 to 16)
	Ferrules	With insulation sleeve: 0.14 to 0.5 mm ² (AWG 26 to 20) Without insulation sleeve: 0.75 to 1.5 mm ² (AWG 18 to 16)

*1. Outer diameter of insulation must be 2.8 mm max.

Refer to page 16 for information on recommended ferrules and crimp tools.

Refer to the common items (page 14) for details on performance.

Wiring Diagram and Dimensions

XW2K-40G-M32

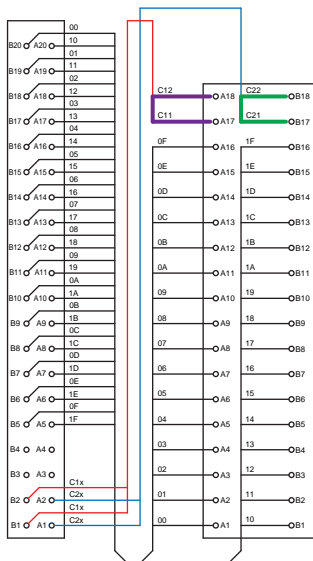

I/O unit signal line (black): 0.5 A, I/O unit common line (red/blue): 2 A
Power supply line (purple/green): 7 A

XW2K-34G-K32

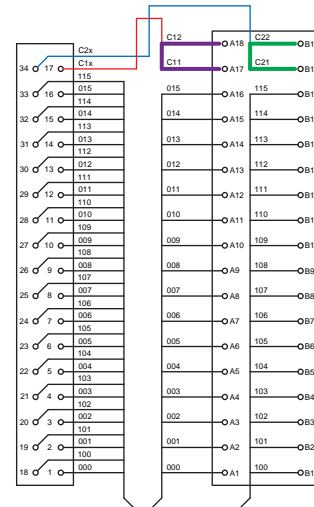

I/O unit signal line (black): 0.5 A, I/O unit common line (red/blue): 1 A
Power supply line (purple/green): 7 A

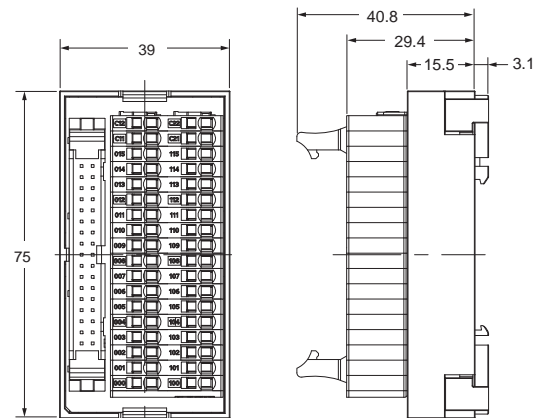
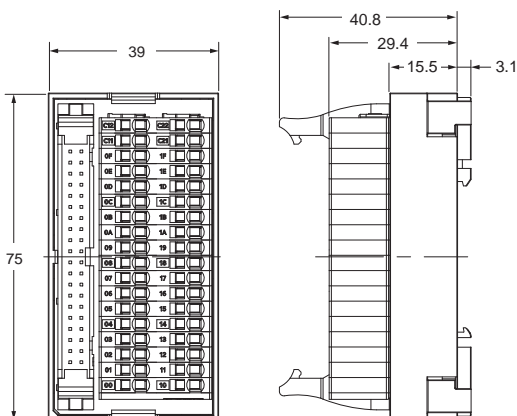

Ultra-Compact Interface Wiring System

XW2K

For PLC Connection (Integrated Common Terminal Type)



Model Number Structure

Model Number Legend

XW2K-□□**G**-□□□□-□□□□
 Series name (1) (2) (3) (4) (5) (6)

- | | | | | |
|--|---|---|---|---|
| (1) Number of Connector poles
20: 20 poles
34: 34 poles
40: 40 poles | (3) PLC manufacturer
O: OMRON, Yokogawa Electric, Hitachi Industrial Equipment Systems
M: Mitsubishi Electric, Fuji Electric
K: KEYENCE | (4) I/O Points
16: 16 Points
32: 32 Points | (5) Circuit pattern
A:
B:
C:
Blank:
Note:
Refer to the following PLC compatibility table. | (6) Power supply terminals
IN: For input
OUT: For output |
|--|---|---|---|---|

PLC Compatibility Table

PLC					Quantity required	Interface Wiring System (integrated common terminal type)	Cable	
Manufacturer name	Series name	I/O	Unit model	I/O Points			Shielded	Unshielded
OMRON	CS	Input	CS1W-ID231	32	1	XW2K-40G-O32A-IN	XW2Z-100B	XW2Z-0100BF-L
			CS1W-ID261	64	2			
		Output	CS1W-OD231, CS1W-OD232	32	1	XW2K-40G-O32B-OUT		
			CS1W-OD261, CS1W-OD262	64	2			
	Mixed I/O (input side)	CS1W-MD261, CS1W-MD262	32	1	XW2K-40G-O32A-IN			
		CS1W-MD561						
	Mixed I/O (output side)	CS1W-MD261, CS1W-MD262	32	1	XW2K-40G-O32B-OUT			
		CS1W-MD561						
	CJ	Input	CJ1W-ID231	32	1	XW2K-40G-O32A-IN	XW2Z-100B	XW2Z-0100BF-L
			CJ1W-ID261	64	2			
			CJ1W-ID232, CJ1W-ID233	32	1	XW2K-40G-O32C-IN		
			CJ1W-ID262	64	2			
		Output	CJ1W-OD231	32	1	XW2K-40G-O32B-OUT		
			CJ1W-OD261	64	2			
			CJ1W-OD232, CJ1W-OD233	32	1	XW2K-40G-O32C-OUT		
			CJ1W-OD234					
		CJ1W-OD262, CJ1W-OD263	64	2				
		Mixed I/O (input side)	CJ1W-MD231	16	1	XW2K-20G-O16A-IN	XW2Z-100A	XW2Z-0100AD-L
			CJ1W-MD233	16	1		XW2Z-100X-R	---
			CJ1W-MD261	32	1	XW2K-40G-O32A-IN	XW2Z-100B	XW2Z-0100BF-L
	CJ1W-MD263, CJ1W-MD563		32	1	XW2Z-100K		XW2Z-0100FF-L	
	Mixed I/O (output side)	CJ1W-MD231	16	1	XW2K-20G-O16B-OUT	XW2Z-100A	XW2Z-0100AD-L	
		CJ1W-MD233	16	1		XW2Z-100X-R	---	
		CJ1W-MD261	32	1	XW2K-40G-O32B-OUT	XW2Z-100B	XW2Z-0100BF-L	
CJ1W-MD263, CJ1W-MD563		32	1	XW2Z-100K		XW2Z-0100FF-L		
NX	Input	NX-ID5142-5	16	1	XW2K-20G-O16A-IN	XW2Z-100X-R	---	
		NX-ID6142-5	32	1				
		NX-ID6142-6	32	1				
	Output	NX-OD5121-5, NX-OD5256-5	16	1	XW2K-20G-O16B-OUT	XW2Z-100X-R	---	
		NX-OD6121-5, NX-OD6256-5	32	1				
		NX-OD6121-6	32	1				
	Mixed I/O (input side)	NX-MD6121-5, NX-MD6256-5	16	1	XW2K-20G-O16A-IN	XW2Z-100X-R	---	
		NX-MD6121-6	16	1				
Mixed I/O (output side)	NX-MD6121-5, NX-MD6256-5	16	1	XW2K-20G-O16B-OUT	XW2Z-100X-R	---		
	NX-MD6121-6	16	1					

					Quantity required					
PLC						Interface Wiring System (integrated common terminal type)	Cable			
Manufacturer name	Series name	I/O	Unit model	I/O Points	Shielded		Unshielded			
Yokogawa Electric	FA-M3	Input	F3XD32-3F, F3XD32-4F F3XD32-5F	32		1		XW2Z-100B	XW2Z-0100BF-L	
			F3XD64-3F, F3XD64-4F	64	2					
		Output	F3YD32-1H, F3YD32-1T, F3YD32-1P	32	1	XW2K-40G-O32B-OUT				
			F3YD64-1P	64	2					
Mixed I/O (input side)	F3WD64-3P, F3WD64-4P	32	1	XW2K-40G-O32A-IN						
Mixed I/O (output side)	F3WD64-3P, F3WD64-4P	32	1	XW2K-40G-O32B-OUT						
Hitachi Industrial Equipment Systems	EH-150/EHV	Input	EH-XD32, EH-XDL32, EH-XDS32, EH-XDB32, EH-XDBL32	32	1	XW2Z-100B	XW2Z-0100BF-L			
			EH-XD64, EH-XDL64 EH-XDB64, EH-XDBL64	64	2					
		Output	EH-YT32	32	1			XW2K-40G-O32B-OUT		
			EH-YT64	64	2					
Mitsubishi Electric	MELSEC L	Input	LX41C4	32	1	XW2Z-100B	XW2Z-0100BF-L			
			LX42C4	64	2					
		Output	LY41NT1P	32	1			XW2K-40G-M32-IN		
			LY42NT1P	64	2			XW2K-40G-M32-OUT		
	Mixed I/O (input side)	LH42C4NT1P	32	1	XW2K-40G-M32-IN					
	Mixed I/O (output side)	LH42C4NT1P	32	1	XW2K-40G-M32-OUT					
	MELSEC Q	Input	QX41, QX41-S1, QX41-S2, QX71	32	1			XW2Z-100B	XW2Z-0100BF-L	
			QX42, QX42-S1, QX72, QX82, QX82-S1	64	2					
		Output	QY41P, QY71	32	1					XW2K-40G-M32-OUT
			QY42P	64	2					
	Mixed I/O (input side)	QH42P, QX41Y41P	32	1	XW2K-40G-M32-IN					
	Mixed I/O (output side)	QH42P, QX41Y41P	32	1	XW2K-40G-M32-OUT					
MELSEC iQ-R	Input	RX41C4, RX71C4, RX41C6HS, RX61C6HS	32	1	XW2Z-100B	XW2Z-0100BF-L				
		RX42C4, RX72C4	64	2						
	Output	RY41NT2P, RY41NT2H	32	1			XW2K-40G-M32-OUT			
		RY42NT2P	64	2						
Mixed I/O (input side)	RH42C4NT2P	32	1	XW2K-40G-M32-IN						
Mixed I/O (output side)	RH42C4NT2P	32	1	XW2K-40G-M32-OUT						
Fuji Electric	MICREX-SX	Input	NP1X3202-W, NP1X3206-W	32	1	XW2Z-100B	XW2Z-0100BF-L			
			NP1X6406-W	64	2					
		Output	NP1Y32T09P1, NP1Y32U09P1	32	1			XW2K-40G-M32-OUT		
			NP1Y64T09P1, NP1Y64U09P1	64	2					
Mixed I/O (input side)	NP1W6406T, NP1W6406U	32	1	XW2K-40G-M32-IN						
Mixed I/O (output side)	NP1W6406T, NP1W6406U	32	1	XW2K-40G-M32-OUT						
KEYENCE	KV-1000	Input	KV-C32XA	32	1	XW2Z-100EE	XW2Z-0100EE-L			
			KV-C64XA	64	2					
		Output	KV-C32TA	32	1			XW2K-34G-K32-OUT		
			KV-C64TA	64	2					
	KV-3000 KV-5000 KV-5500 KV-7000 KV-8000	Input	KV-C32XC	32	1			XW2K-34G-K32-IN		
			KV-C64XC	64	2					
		Output	KV-C32TC, KV-C32TD	32	1				XW2K-34G-K32-OUT	
			KV-C64TC, KV-C64TD	64	2					
	Mixed I/O (input side)	KV-C32XTD	32	1	XW2K-34G-K32-IN					
	Mixed I/O (output side)	KV-C32XTD	32	1	XW2K-34G-K32-OUT					
KV Nano	Input	KV-NC32EX	32	1	XW2K-34G-K32-IN					
		KV-NC32ET	32	1						
	Output	KV-NC32EXT	32	1		XW2K-34G-K32-OUT				
		KV-NC32EXT	32	1						

Note: 1. This terminal block is a sink (NPN) type-compatible product. For source (PNP) use, reverse the polarity of the external power supply and the power source for I/O devices.
 2. The cable model to use is one with a cable length of 1 m. Refer to the section from page 18 for details.
 3. Caution is required when connecting with Yokogawa Electric, Hitachi Industrial Equipment Systems, and Fuji Electric PLCs. The PLC address is in the order of left to right, but the PLC address indication printed on the top surface of the terminal block follows that of the representative manufacturer.
 · For Yokogawa Electric and Hitachi Industrial Equipment Systems PLCs ⇒ Address indication of OMRON PLCs
 · For Fuji Electric PLCs ⇒ Address indication of Mitsubishi Electric PLCs

For PLC Connection

For PLC Connection (integrated Common Terminal Type)

General-Purpose

Common Terminal Blocks

Common Items for Terminal Blocks



Cable (Shielded)

Cable (Unshielded)

XW2K

For OMRON PLC Connection

Ordering Information

Appearance	Mounted connector	I/O Points	PWB color	Model	Dimension (mm)
	MIL 20 poles	16	Green	XW2K-20G-O16A-IN	When installed vertically: 52.7 x 75 x 40.8 When installed horizontally: 75 x 52.7 x 40.8
			Blue	XW2K-20G-O16B-OUT	When installed vertically: 39 x 75 x 40.8 When installed horizontally: 75 x 39 x 40.8

Ratings

Rated voltage	30 VDC
Rated current	I/O unit signal line: 0.5 A, I/O unit common line: 2 A, Power supply line: 4 A
Applicable wire *1	Stranded wire, solid wire
	Ferrules
0.08 to 1.5 mm ² (AWG 28 to 16)	
With insulation sleeve: 0.14 to 0.5 mm ² (AWG 26 to 20)	
Without insulation sleeve: 0.75 to 1.5 mm ² (AWG 18 to 16)	

*1. Outer diameter of insulation must be 2.8 mm max.

Refer to page 16 for information on recommended ferrules and crimp tools.

Refer to the common items (page 14) for details on performance.

Wiring Diagram and Dimensions

XW2K-20G-O16A-IN

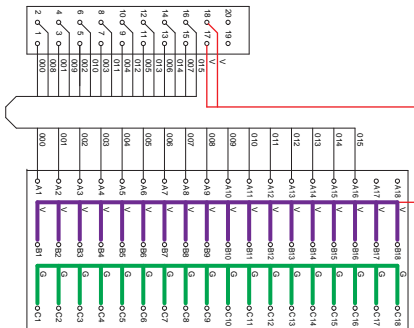

XW2K-20G-O16B-OUT

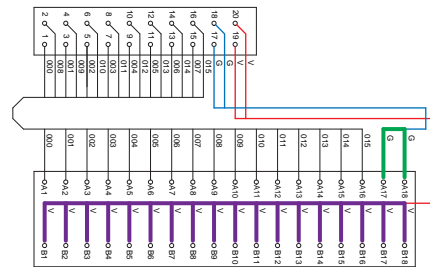

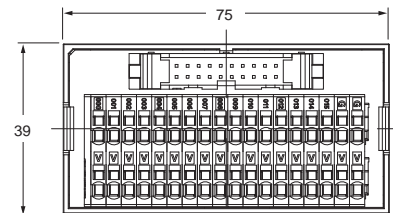
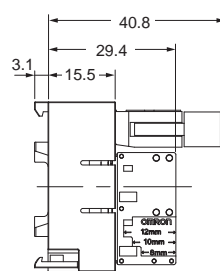
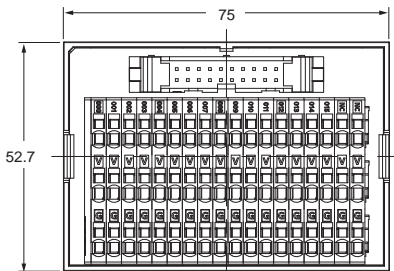
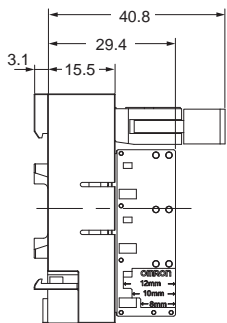

I/O unit signal line (black): 0.5 A, I/O unit common line (red/blue): 2 A, Power supply line (purple/green): 4 A



For OMRON, Yokogawa Electric, or Hitachi Industrial Equipment Systems PLC Connection

Ordering Information

Appearance *1	Mounted connector	I/O Points	PWB color	Model	Dimension (mm)
 	MIL 40 poles	32	Green	XW2K-40G-O32A-IN	When installed vertically: 52.7 x 124 x 40.8 When installed horizontally: 124 x 52.7 x 40.8
			Black	XW2K-40G-O32C-IN	
			Blue	XW2K-40G-O32B-OUT	When installed vertically: 39 x 124 x 40.8 When installed horizontally: 124 x 39 x 40.8
			Black	XW2K-40G-O32C-OUT	

*1. The appearance shows the models of circuit patterns A and B. Circuit pattern C (XW2K-40G-O32C-IN/OUT) has a different appearance and the board color is black.

Ratings

Rated voltage	30 VDC	
Rated current	I/O unit signal line: 0.5 A, I/O unit common line: 4 A, Power supply line: 7 A	
Applicable wire *2	Stranded wire, solid wire	0.08 to 1.5 mm ² (AWG 28 to 16)
	Ferrules	With insulation sleeve: 0.14 to 0.5 mm ² (AWG 26 to 20) Without insulation sleeve: 0.75 to 1.5 mm ² (AWG 18 to 16)

*2. Outer diameter of insulation must be 2.8 mm max.

Refer to page 16 for information on recommended ferrules and crimp tools.

Refer to the common items (page 14) for details on performance.

Wiring Diagram and Dimensions

XW2K-40G-O32A-IN

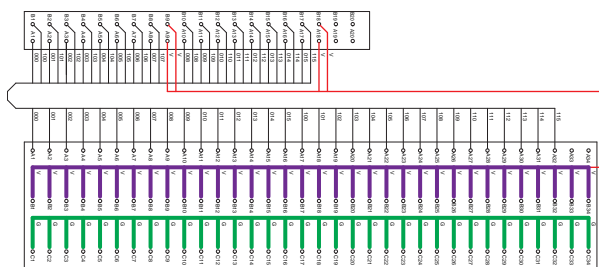

XW2K-40G-O32B-OUT



XW2K-40G-O32C-IN

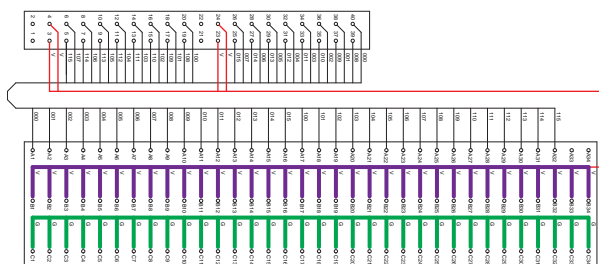

XW2K-40G-O32C-OUT

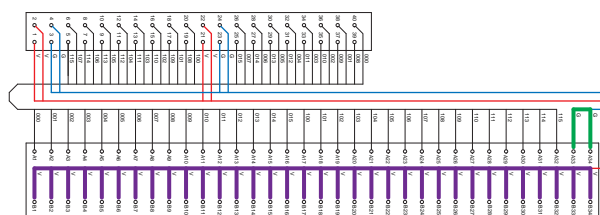

I/O unit signal line (black): 0.5 A, I/O unit common line (red/blue): 4 A, Power supply line (purple/green): 7 A

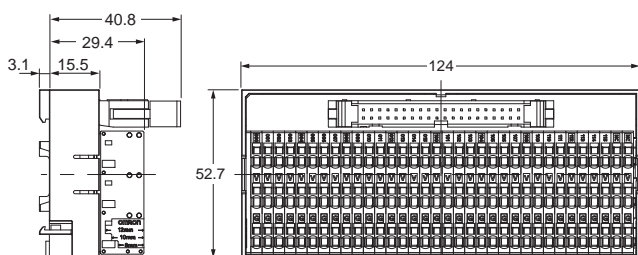

Note: The dimensions diagram is common for both models.

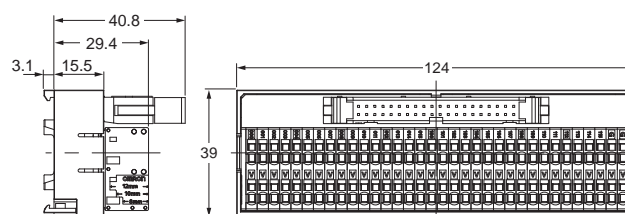



Note: The dimensions diagram is common for both models.

XW2K

For Mitsubishi Electric or Fuji Electric PLC Connection

Ordering Information

Appearance	Mounted connector	I/O Points	PWB color	Model	Dimension (mm)
	MIL 40 poles	32	Black	XW2K-40G-M32-IN	When installed vertically: 52.7 x 124 x 40.8 When installed horizontally: 124 x 52.7 x 40.8
				XW2K-40G-M32-OUT	When installed vertically: 39 x 124 x 40.8 When installed horizontally: 124 x 39 x 40.8

Ratings

Rated voltage	30 VDC	
Rated current	I/O unit signal line: 0.5 A, I/O unit common line: 2 A, Power supply line: 7 A	
Applicable wire #1	Stranded wire, solid wire	0.08 to 1.5 mm ² (AWG 28 to 16)
	Ferrules	With insulation sleeve: 0.14 to 0.5 mm ² (AWG 26 to 20) Without insulation sleeve: 0.75 to 1.5 mm ² (AWG 18 to 16)

*1. Outer diameter of insulation must be 2.8 mm max.

Refer to page 16 for information on recommended ferrules and crimp tools.

Refer to the common items (page 14) for details on performance.

Wiring Diagram and Dimensions

XW2K-40G-M32-IN

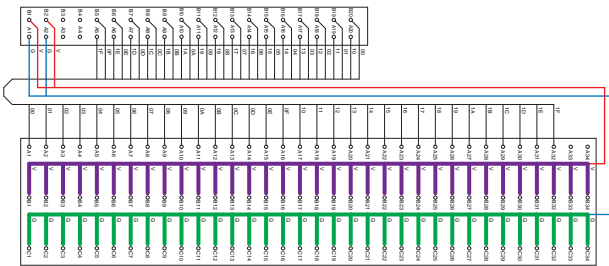

XW2K-40G-M32-OUT

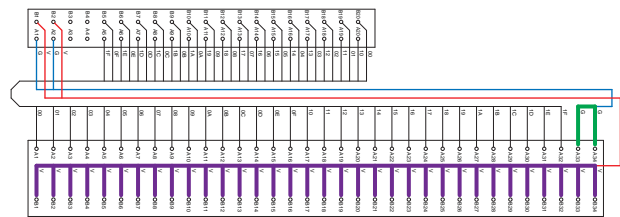

I/O unit signal line (black): 0.5 A, I/O unit common line (red/blue): 2 A, Power supply line (purple/green): 7 A

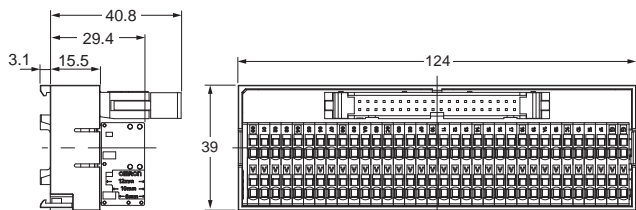
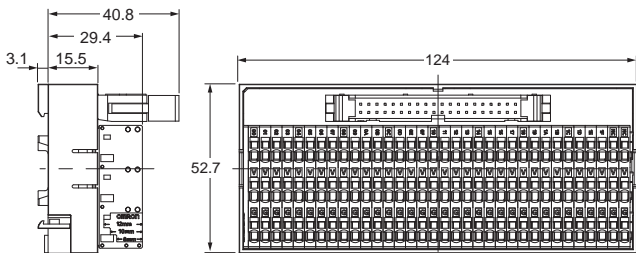

For PLC Connection

For PLC Connection (Integrated Common Terminal Type)

General-Purpose

Common Terminal Blocks



Common Items for Terminal Blocks

Cable (Shielded)

Cable (Unshielded)

For KEYENCE PLC Connection

Ordering Information

Appearance	Mounted connector	I/O Points	PWB color	Model	Dimension (mm)
	MIL 34 poles	32	Black	XW2K-34G-K32-IN	When installed vertically: 52.7 x 124 x 40.8 When installed horizontally: 124 x 52.7 x 40.8
				XW2K-34G-K32-OUT	When installed vertically: 39 x 124 x 40.8 When installed horizontally: 124 x 39 x 40.8

Ratings

Rated voltage		30 VDC
Rated current		I/O unit signal line: 0.5 A, I/O unit common line: 2 A, Power supply line: 7 A
Applicable wire *1	Stranded wire, solid wire	0.08 to 1.5 mm ² (AWG 28 to 16)
	Ferrules	With insulation sleeve: 0.14 to 0.5 mm ² (AWG 26 to 20) Without insulation sleeve: 0.75 to 1.5 mm ² (AWG 18 to 16)

*1. Outer diameter of insulation must be 2.8 mm max.

Refer to page 16 for information on recommended ferrules and crimp tools.

Refer to the common items (page 14) for details on performance.

Wiring Diagram and Dimensions

XW2K-34G-K32-IN

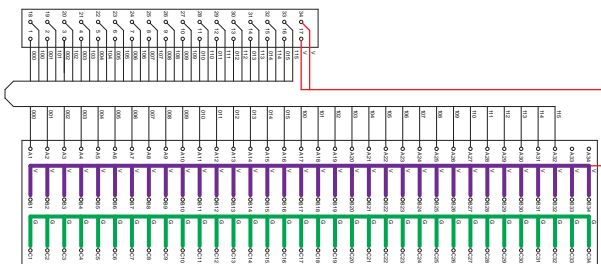

XW2K-34G-K32-OUT

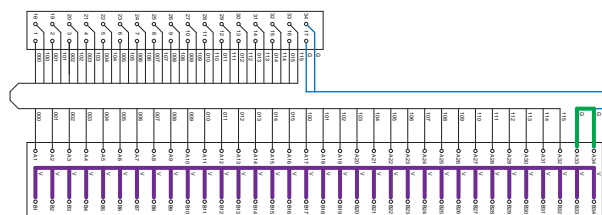

I/O unit signal line (black): 0.5 A, I/O unit common line (red/blue): 2 A, Power supply line (purple/green): 7 A

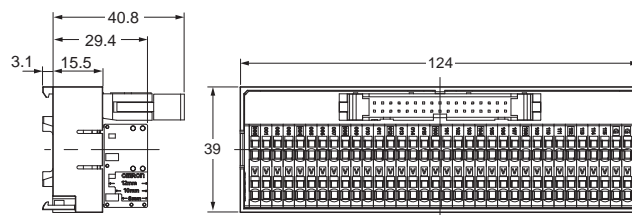
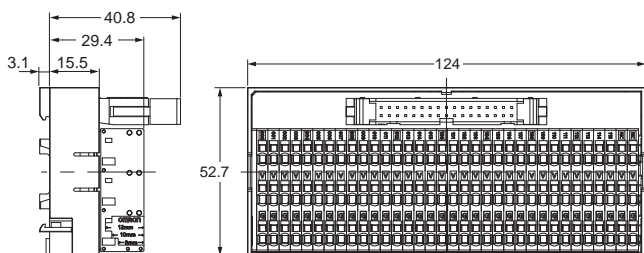

For PLC Connection

For PLC Connection
(Integrated Common Terminal Type)

General-Purpose

Common
Terminal Blocks

Common Items
for Terminal Blocks

Cable (Shielded)

Cable (Unshielded)

XW2K

Ultra-Compact Interface Wiring System

XW2K

General-Purpose



Model Number Structure

Model Number Legend

XW2K-□□G-T

Series name (1) (2) (3)

- (1) Number of Connector poles: 20, 34, 40, 50
- (2) Mounted connector: G: MIL
- (3) Wiring: T: Straight wiring (1:1 wiring)

Ordering Information

Appearance	Mounted connector	terminal block poles	PWB color	Model	Dimension A (mm)	Dimension (mm)
	MIL 20 poles	20	Black	XW2K-20G-T	56	When installed vertically: 39 x A x 40.8 When installed horizontally: A x 39 x 40.8
	MIL 34 poles	34		XW2K-34G-T	75	
	MIL 40 poles	40		XW2K-40G-T	75	
	MIL 50 poles	50		XW2K-50G-T	92.5	

Ratings

Rated voltage	125 VAC, 30 VDC *1	
Rated current	1 A	
Applicable wire *2	Stranded wire, solid wire	0.08 to 1.5 mm ² (AWG 28 to 16)
	Ferrules	With insulation sleeve: 0.14 to 0.5 mm ² (AWG 26 to 20) Without insulation sleeve: 0.75 to 1.5 mm ² (AWG 18 to 16)

*1. Only "30 VDC" is printed on the main unit.
*2. Outer diameter of insulation must be 2.8 mm max.

Refer to page 16 for information on recommended ferrules and crimp tools.
Refer to the common items (page 14) for details on performance.

Wiring Diagram and Dimensions:

XW2K-40G-T

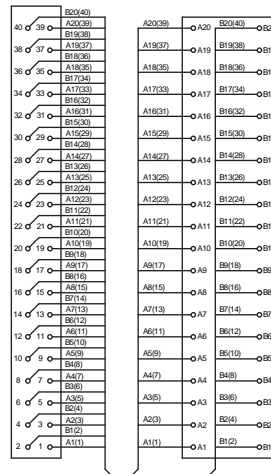
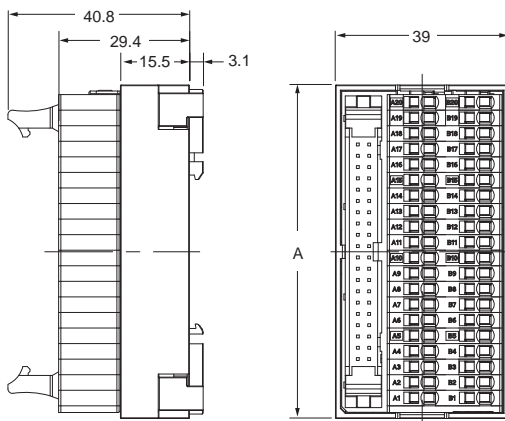

Note: Example of 40 poles

Ultra-Compact Common Terminal Blocks (For Sensor Power Supply*) XW2K-COM

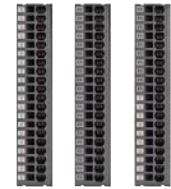

* This model is small and ideal for sensor power supply, but it can be used for uses other than sensor power supply (e.g. AC circuit).

Model Number Structure

Model Number Legend

XW2K-COM 20 □

Series name (1) (2)

- | | |
|--|--|
| (1) Number of poles
20: 20 poles | (2) Application
P: For + common
N: For - common
Blank: +/- mix |
|--|--|

Ordering Information

Appearance	Number of poles	Application	PWB color	Model	Dimension (mm)
	20	For + common	Black	XW2K-COM20P	14.8 x 75 x 29.4
		For - common		XW2K-COM20N	
		+/- mix		XW2K-COM20	

Ratings

Rated voltage	250 VAC/VDC	
Rated current	10 A	
Applicable wire *1	Stranded wire, solid wire	0.08 to 1.5 mm ² (AWG 28 to 16)
	Ferrules	With insulation sleeve: 0.14 to 0.5 mm ² (AWG 26 to 20) Without insulation sleeve: 0.75 to 1.5 mm ² (AWG 18 to 16)

*1. Outer diameter of insulation must be 2.8 mm max.

Refer to page 16 for information on recommended ferrules and crimp tools.
Refer to the common items (page 14) for details on performance.

Wiring Diagram and Dimensions

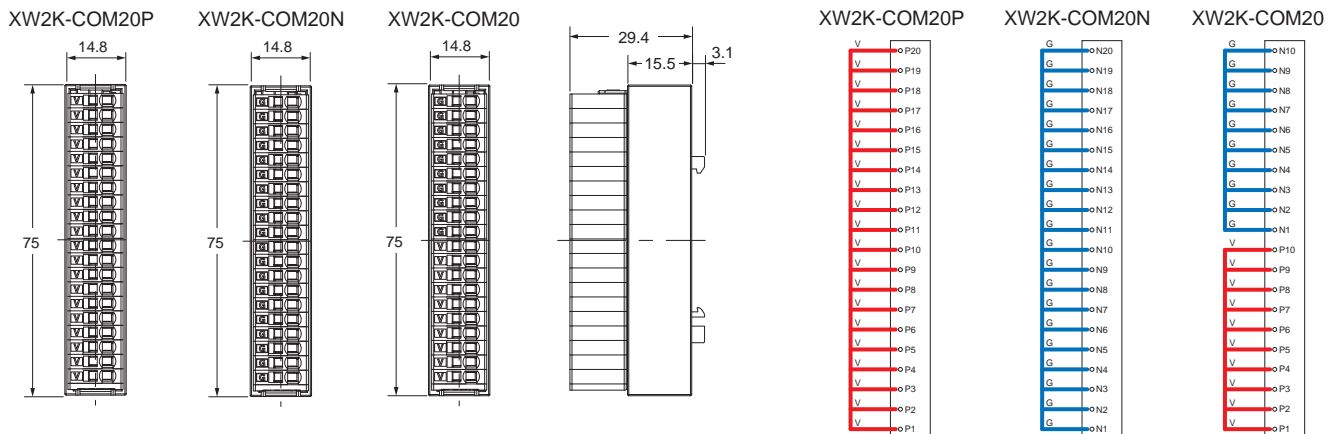

For PLC Connection

For PLC Connection (Integrated Common Terminal Type)

General-Purpose

Common Terminal Blocks

Common Items for Terminal Blocks

Cable (Shielded)

Cable (Unshielded)

Common Items for Terminal Blocks

Specifications

Series	Ultra-compact interface wiring system XW2K For PLC connection, For PLC connection (integrated Common Terminal Type), General-purpose	Ultra-Compact common terminal blocks (for sensor power supply) XW2K-COM
Ambient operating temperature	-20 to +75°C (with no condensation or icing)	
Ambient operating humidity	5 to 95% RH (with no condensation)	
Insulation resistance	100 MΩ min. (at 500 VDC)	
Withstand voltage	500 VAC for 1 min (leakage current: 1 mA max.)	1500 VAC for 1 min (leakage current: 1 mA max.)
Insertion durability	50 times	
Vibration resistance	10 to 150 Hz, acceleration of 50 m/s ² for 80 min each in X, Y, and Z directions	
Shock resistance	500 m/s ² for 11 ms each in 6 directions 5 times	
Ambient storage temperature	-20 to +75°C (with no condensation or icing)	
Ambient storage humidity	5 to 95% RH (with no condensation)	

Standards

Compliant standard

- UL 1977

Certification

- cURus (File No. E103202)

Safety Precautions

Warning Indications

Precautions for Safe Use	Supplementary comments on what to do or avoid doing, to use the product safely.
Precautions for Correct Use	Supplementary comments on what to do or avoid doing, to prevent failure to operate, malfunction, or undesirable effects on product performance.

Precautions for Safe Use

- Do not drop the Terminal Block. Terminal Block functionality may be inhibited.
- Terminal Block is designed to satisfy the functions when mounting on the DIN Track. Always mount on the DIN Track.
- Do not exceeds the ratings. Doing so may result failure or burning.
- Do not use Terminal Blocks in locations where toxic gases, such as sulfide gas (H₂S and SO₂), ammonia gas (NH₃), nitrogen gas (HNO₃), chlorine gas (Cl₂), or in locations subject to high temperature or humidity. Doing so may cause functional failure, such as damages due to contact failure or corrosion.
- Do not use the Terminal Blocks submersed in oil or water, or in locations continuously subject to splashes of oil or water. Doing so may result in oil or water entering and damaging the Terminal Blocks.
- Do not use or keep the Terminal Blocks under the following conditions:
 - Subject to severe temperature changes.
 - Subject to high humidity and condensation.
 - Subject to severe vibration or shock.
 - Where direct rays of the sun strike.
 - Where sea breeze may be present.
- When disposing, dispose the Terminal Blocks as industrial wastes.
- Do not wire anything to the release holes.

- Do not tilt or twist a flat-blade screwdriver as shown in the figure while it is inserted into a release hole on the terminal block. The terminal block may be damaged.

Not Correct

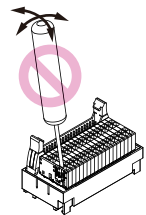

- Insert a flat-blade screwdriver into the release holes at an angle. The terminal block may be damaged if you insert the screwdriver straight in.
- Do not allow the flat-blade screwdriver to fall out while it is inserted into a release hole.
- Do not bend a wire past its natural bending radius or pull on it with excessive force. Doing so may sever the cable. Do not apply excessive force to the Terminal Blocks. Doing so may cause connection failure due to damage or deformation.
- Do not presolder the ends of the wires. The wires will become unable to be connected correctly.
- Do not insert more than one wire into each terminal insertion hole.
- Do not use wires with discoloration, doing so may cause conduction failure.
- When stripping the wire coatings, be sure not to damage the core wire. Doing so may cause connection failure.
- Do not perform wiring with wet hands. Doing so may result operation failure or malfunction when power is supplied.
- To prevent wiring materials from smoking or ignition, use the wiring materials given in the following table with referring the ratings of wires.

	Recommended wire		Stripping length (Ferrules not used)
	Stranded wire	Solid wire	
XW2K	0.08 to 1.5 mm ² / AWG 28 to 16	0.08 to 1.5 mm ² / AWG 28 to 16	8 mm

Precautions for Correct Use

1. Precautions for Correct Use

Wiring Precautions

- Always turn OFF the power supply before wiring. Electrical shock may occur.
- When wiring the terminal block, do not subject it or the wires to stress. Secure the wires so that they do not resonate with vibrations from the facilities in installation conditions.

2. Connecting Wires to the Push-In Plus Terminal Block

Part Names of the Terminal Block

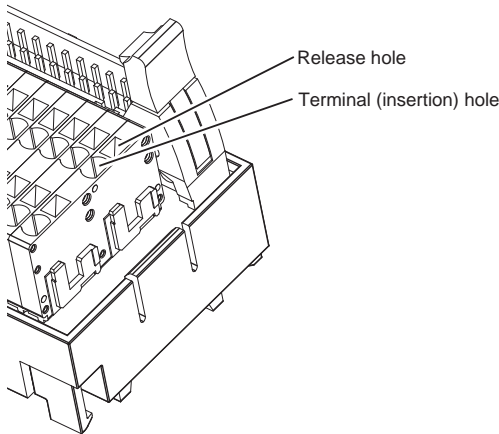

Connecting Wires with Ferrules (hereinafter referred to as Ferrules) and Solid Wires

Insert the solid wire or ferrule straight into the Terminal Block until the end strikes the Terminal Block.

If a wire is difficult to connect because it is too thin, use a flat-blade screwdriver in the same way as when connecting stranded wire.

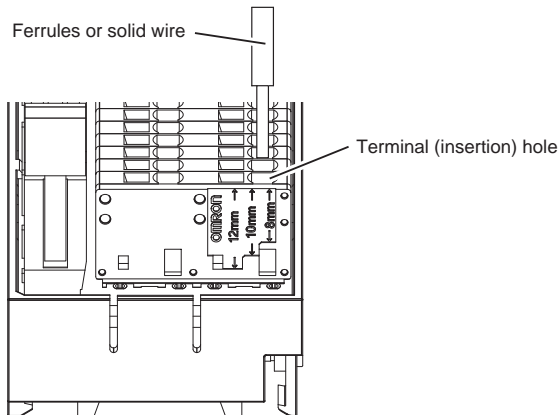

Connecting Stranded Wires

Use the following procedure to connect the wires to the terminal block.

1. Hold a flat-blade screwdriver at an angle and insert it into the release hole.
The angle should be between 10° and 15°. If the flat-blade screwdriver is inserted correctly, you will feel the spring in the release hole respond.
2. With the flat-blade screwdriver still inserted into the release hole, insert the wire into the terminal hole until it strikes the terminal block. Always twist stranded wires together before inserting them.
3. Remove the flat-blade screwdriver from the release hole.

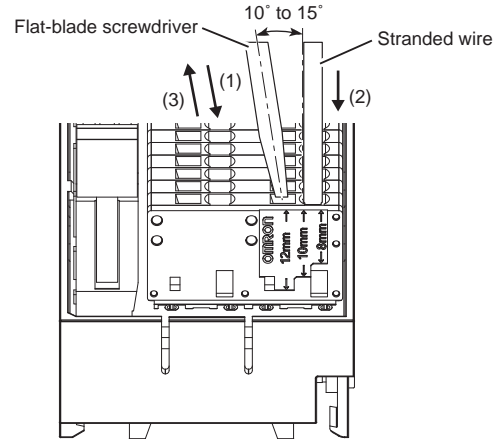

Checking Connections

- After the insertion, pull gently on the wire to make sure that it will not come off and the wire is securely fastened to the terminal block.
- To prevent short circuits, insert the stripped part of a stranded or solid wire or the conductor part of a ferrule until it is hidden inside the terminal insertion hole.

3. Removing Wires from the Push-In Plus Terminal Block

Use the following procedure to remove wires from the terminal block. The same method is used to remove stranded wires, solid wires, and ferrules.

1. Hold a flat-blade screwdriver at an angle and insert it into the release hole.
2. With the flat-blade screwdriver still inserted into the release hole, remove the wire from the terminal insertion hole.
3. Remove the flat-blade screwdriver from the release hole.

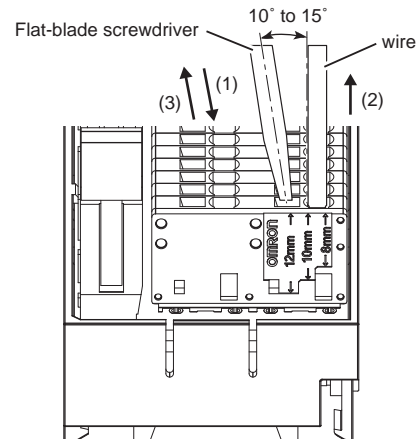

Common Items for Terminal Blocks

4. Recommended Ferrules and Crimp Tools

Recommended ferrules

XW2K

Applicable wire		Ferrule Conductor length (mm)	Stripping length (mm) (Ferrules used)	Recommended ferrules		
(mm ²)	(AWG)			Manufactured by Phoenix Contact *	Manufactured by Weidmuller	Manufactured by Wago
0.14	26	8	10	AI 0,14-8	H0.14/12	---
0.25	24	8	10	AI 0,25-8	H0.25/12	216-301
		10	12	AI 0,25-10	---	---
0.34	22	8	10	AI 0,34-8	H0.34/12	216-302
		10	12	AI 0,34-10	---	---
0.50	20	8	10	AI 0,5-8	H0.5/14	216-201
		10	12	AI 0,5-10	H0.5/16	216-241
Recommended crimp tools				CRIMPFOX6 CRIMPFOX6T-F CRIMPFOX10S	PZ6 roto	Variocrimp4

* The above recommended ferrules manufactured by Phoenix Contact do not include models ending in "-GB".

Models ending in "-GB" are not recommended because the inner diameter of the insulation sleeve is larger than standard model (models not ending in "-GB").

- Note:**
1. Make sure that the outer diameter of the wire is smaller than the inner diameter of the insulation sleeve of the recommended ferrule.
 2. Make sure that the ferrule processing dimensions conform to the following figure.

Processing dimensions of ferrules

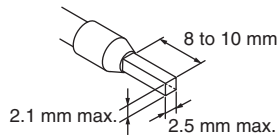

3. For the ferrule which is for applicable wire (0.75 to 1.5 mm²/ AWG 18 to 16), please use a ferrule without an insulation sleeve. (Refer to the following table.)

Applicable wire		Ferrule Conductor length (mm)	Stripping length (mm) (Ferrules used)	Recommended ferrules		
(mm ²)	(AWG)			Manufactured by Phoenix Contact	Manufactured by Weidmuller	Manufactured by Wago
0.75	18	8	10	A 0,75-8	---	F-0.75-8
		10	12	A 0,75-10	H0,75/10	F-0.75-10
1/1.25	18/17	8	8	A 1-8	---	F-1.0-8
		10	10	A 1-10	H1,0/10	F-1.0-10
1.25/1.5	17/16	10	10	A 1,5-10	H1,5/10	F-1.5-10
Recommended crimp tools				CRIMPFOX6 CRIMPFOX6T-F CRIMPFOX10S	PZ6 roto	Variocrimp4

Recommended Flat-blade Screwdriver

Use a flat-blade screwdriver to connect and remove wires. Use the following flat-blade screwdriver. The following table shows manufacturers and models as of 2021/Dec.

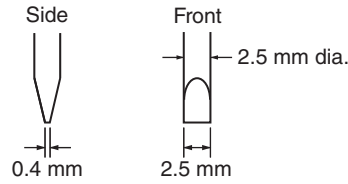

Model	Manufacturer
ESD 0,40x2,5	Wera
SZS 0,4x2,5 SZF 0-0,4x2,5 *	Phoenix Contact
0,4x2,5x75 302	Wiha
AEF,2,5x75	Facom
210-719	Wago
SDIS 0,4x2,5x75	Weidmuller
9900(-2,5x75)	Vessel

* OMRON's exclusive purchase model XW4Z-00B is available to order as SZF 0-0,4 x 2,5 (manufactured by Phoenix Contact).

5. Mounting to DIN Track/Removing from DIN Track

[Mounting to DIN track vertically]

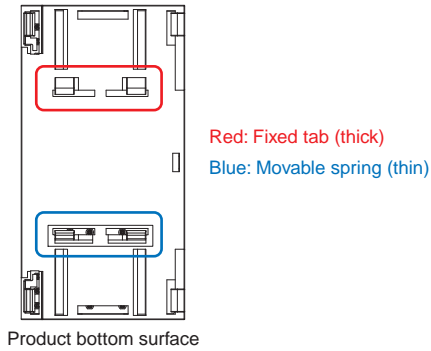

[Mounting to DIN track horizontally]

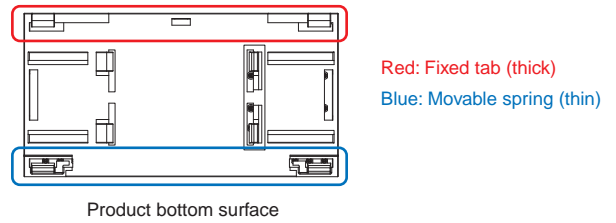

Mounting Method

Hook fixed tab (1).
Push terminal block (2) onto the DIN track.

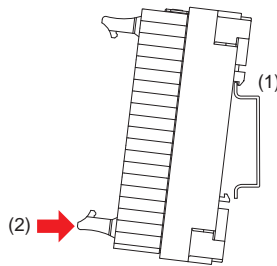

Mounting Method

Hook fixed tab (1).
Push terminal block (2) onto the DIN track.

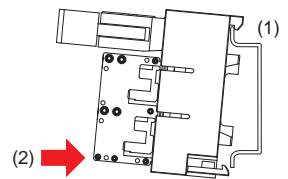

Removal Method

While pressing case (1) upward,
pull the fixed tab side (2) forward.

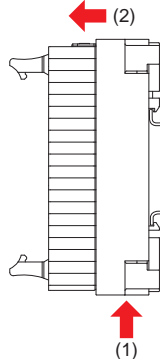

Removal Method

While pressing case (1) upward,
pull the fixed tab side (2) forward.

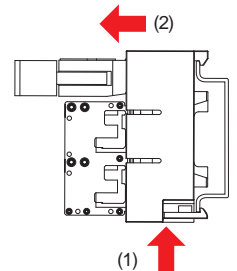

Note (Mounting Method)

If it is difficult to push the front of the main unit due to the wire connections, or if the mounting is hard due to individual differences in track types, it is possible to attach it to the DIN rail with a relatively light force while holding the lower part of the main unit by the mounting method shown in the figure below.

Hook movable spring (1)'.
Push bottom (2)' of the terminal block upward with the terminal block tilted diagonally in relation to the DIN track.

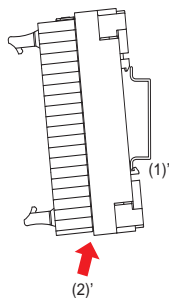

Hook movable spring (1)'.
Push bottom (2)' of the terminal block upward with the terminal block tilted diagonally in relation to the DIN track.

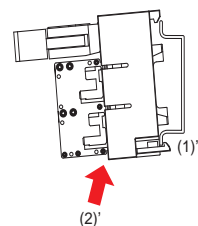

Connecting Cables for Interface Wiring System (Shielded)

XW2Z

Connect Interface Wiring System (XW2□□) to I/O Units for Programmable Controllers with one touch.

Shielded



Ratings and Specifications

Rated current	1 A
Rated voltage	125 VAC 30 VDC
Contact resistance	20 mΩ max. (at 20 mV, 100 mA max.) *1
Insulation resistance	100 MΩ min. (at 500 VDC)
Dielectric strength	500 VAC for 1 min (leakage current: 1 mA max.) *2
Ambient operating temperature	-20 to +75°C (with no condensation or icing) *3

Note: This cable is for fixed parts. Do not use it for moving parts.

*1. Contact resistance for the Connector.

*2. Dielectric strength for the Connector.

*3. However, when bending the cable to perform wiring, maintenance, and other work, do so within the temperature range of 0 to 75°C in consideration of severing of the cable.

Materials and Finish

XW2Z-□□□A

FCN 24-pin – MIL 20-pin, Straight Wiring

Appearance	Model	Cable length L (m)	Sheath outer diameter (mm)/ Minimum bending radius (mm)
	XW2Z-050A	0.5	7.8 dia./R63
	XW2Z-100A	1	
	XW2Z-150A	1.5	
	XW2Z-200A	2	
	XW2Z-300A	3	
	XW2Z-500A	5	
	XW2Z-700A	7	
	XW2Z-010A	10	
	XW2Z-15MA	15	
	XW2Z-20MA	20	

Cable length L (m)

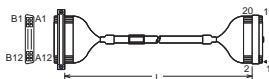

Wiring Diagram

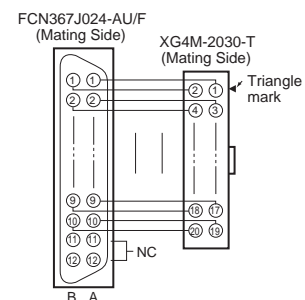

XW2Z-□□□X

MIL 20-pin – MIL 20-pin, Straight Wiring

Appearance	Model	Cable length L (m)	Sheath outer diameter (mm)/ Minimum bending radius (mm)
	XW2Z-C50X	0.5	7.8 dia./R63
	XW2Z-100X	1	
	XW2Z-200X	2	
	XW2Z-300X	3	
	XW2Z-500X	5	
	XW2Z-010X	10	

Cable length L (m)



Wiring Diagram

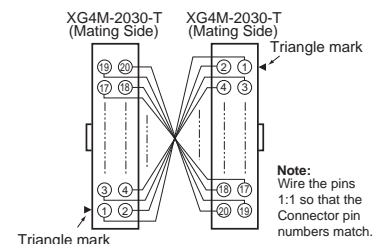

XW2Z-□□□X-R

MIL 20-pin – MIL 20-pin, Reverse Wiring

Appearance	Model	Cable length L (m)	Sheath outer diameter (mm)/ Minimum bending radius (mm)
	XW2Z-C50X-R	0.5	7.8 dia./R63
	XW2Z-100X-R	1	
	XW2Z-200X-R	2	

Cable length L (m)



Wiring Diagram

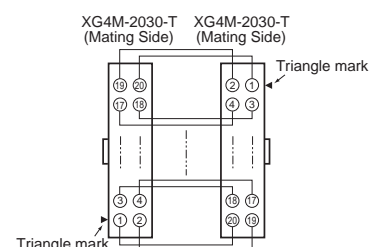

For PLC Connection

For PLC Connection (Integrated Common Terminal Type)

General-Purpose

Common Terminal Blocks

Common Items for Terminal Blocks

Cable (Shielded)

Cable (Unshielded)

XW2Z-□□□EE

MIL 34-pin – MIL 34-pin, Straight Wiring

Appearance	Model	Cable length L (m)	Sheath outer diameter (mm)/ Minimum bending radius (mm)
	XW2Z-050EE	0.5	9.8 dia./R79
	XW2Z-100EE	1	
	XW2Z-150EE	1.5	
	XW2Z-200EE	2	
	XW2Z-300EE	3	
	XW2Z-500EE	5	

Cable length L (m)

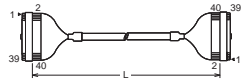

Wiring Diagram

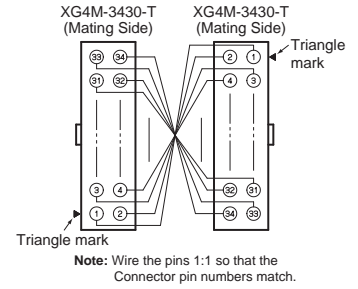

XW2Z-□□□B

FCN 40-pin – MIL 40-pin, Straight Wiring

Appearance	Model	Cable length L (m)	Sheath outer diameter (mm)/ Minimum bending radius (mm)
	XW2Z-050B	0.5	10.4 dia./R84
	XW2Z-100B	1	
	XW2Z-150B	1.5	
	XW2Z-200B	2	
	XW2Z-300B	3	
	XW2Z-500B	5	
	XW2Z-700B	7	
	XW2Z-010B	10	
	XW2Z-15MB	15	
	XW2Z-20MB	20	

Cable length L (m)

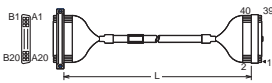

Wiring Diagram

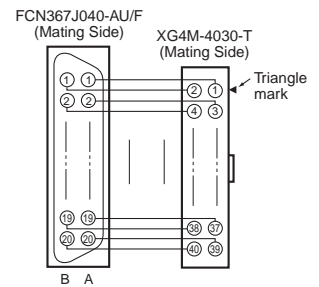

XW2Z-□□□K

MIL 40-pin – MIL 40-pin, Straight Wiring

Appearance	Model	Cable length L (m)	Sheath outer diameter (mm)/ Minimum bending radius (mm)
	XW2Z-C25K	0.25	10.4 dia./R84
	XW2Z-C50K	0.5	
	XW2Z-100K	1	
	XW2Z-150K	1.5	
	XW2Z-200K	2	
	XW2Z-300K	3	
	XW2Z-010K	10	

Cable length L (m)

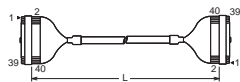

Wiring Diagram

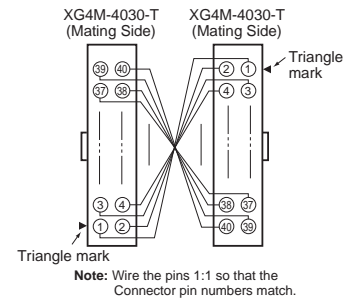

XW2Z-□□□Y

MIL 50-pin – MIL 50-pin, Straight Wiring

Appearance	Model	Cable length L (m)	Sheath outer diameter (mm)/ Minimum bending radius (mm)
	XW2Z-C25Y	0.25	10.9 dia./R88
	XW2Z-C50Y	0.5	
	XW2Z-100Y	1	
	XW2Z-150Y	1.5	
	XW2Z-200Y	2	
	XW2Z-300Y	3	
	XW2Z-010Y	10	

Cable length L (m)



Wiring Diagram

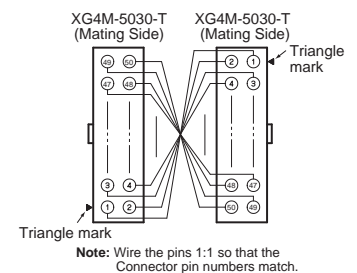

For PLC Connection

For PLC Connection (Integrated Common Terminal Type)

General-Purpose

Common Terminal Blocks

Common Items for Terminal Blocks

Cable (Shielded)

Cable (Unshielded)

Connecting Cables for Interface Wiring System (Unshielded)

XW2Z-L

Connect Interface Wiring System (XW2□) to I/O Units for Programmable Controllers with one touch.



Unshielded

Ratings and Specifications

Rated current	1 A
Rated voltage	125 VAC 30 VDC
Contact resistance	20 mΩ max. (at 20 mV, 100 mA max.) *1
Insulation resistance	100 MΩ min. (at 500 VDC)
Dielectric strength	500 VAC for 1 min (leakage current: 1 mA max.) *2
Ambient operating temperature	-20 to +75°C (with no condensation or icing) *3

Note: This cable is for fixed parts. Do not use it for moving parts.

*1. Contact resistance for the Connector.

*2. Dielectric strength for the Connector.

*3. However, when bending the cable to perform wiring, maintenance, and other work, do so within the temperature range of 0 to 75°C in consideration of severing of the cable.

Materials and Finish

XW2Z-□□□AD-L

FCN 24-pin – MIL 20-pin, Straight Wiring

Appearance	Model	Cable length L (m)	Sheath outer diameter (mm)/ Minimum bending radius (mm)
	XW2Z-0050AD-L	0.5	6.7 dia./R54
	XW2Z-0100AD-L	1	
	XW2Z-0200AD-L	2	
	XW2Z-0300AD-L	3	

Cable length L (m)

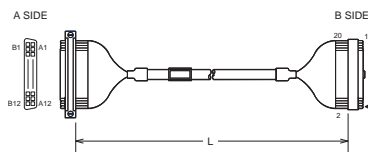

Wiring Diagram

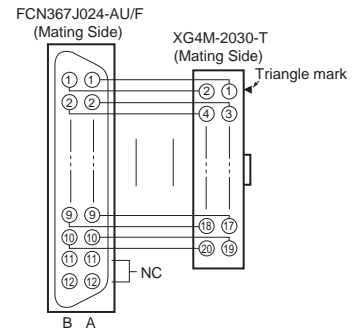

XW2Z-□□□DD-L

MIL 20-pin – MIL 20-pin, Straight Wiring

Appearance	Model	Cable length L (m)	Sheath outer diameter (mm)/ Minimum bending radius (mm)
	XW2Z-0050DD-L	0.5	6.7 dia./R54
	XW2Z-0100DD-L	1	
	XW2Z-0200DD-L	2	

Cable length L (m)

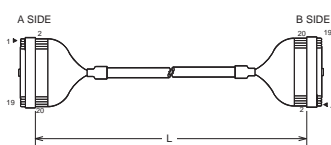

Wiring Diagram

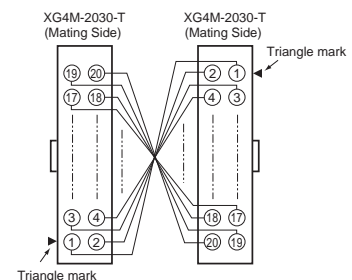

Note: Wire the pins 1:1 so that the Connector pin numbers match.

For PLC Connection

For PLC Connection
(Integrated Common Terminal Type)

General-Purpose

Common Terminal Blocks

Common Items for Terminal Blocks

Cable (Shielded)

Cable (Unshielded)

XW2Z-□□□EE-L

MIL 34-pin – MIL 34-pin, Straight Wiring

Appearance	Model	Cable length L (m)	Sheath outer diameter (mm)/ Minimum bending radius (mm)
	XW2Z-0050EE-L	0.5	8.2 dia./R66
	XW2Z-0100EE-L	1	
	XW2Z-0150EE-L	1.5	
	XW2Z-0200EE-L	2	
	XW2Z-0300EE-L	3	
	XW2Z-0500EE-L	5	
	XW2Z-0700EE-L	7	
	XW2Z-1000EE-L	10	

Cable length L (m)

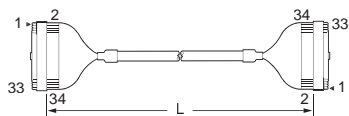

Wiring Diagram

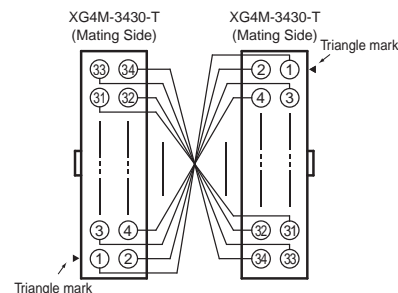

Note: Wire the pins 1:1 so that the Connector pin numbers match.

XW2Z-□□□BF-L

FCN 40-pin – MIL 40-pin, Straight Wiring

Appearance	Model	Cable length L (m)	Sheath outer diameter (mm)/ Minimum bending radius (mm)
	XW2Z-0050BF-L	0.5	8.2 dia./R66
	XW2Z-0100BF-L	1	
	XW2Z-0150BF-L	1.5	
	XW2Z-0200BF-L	2	
	XW2Z-0300BF-L	3	
	XW2Z-0500BF-L	5	
	XW2Z-0700BF-L	7	
	XW2Z-1000BF-L	10	

Cable length L (m)

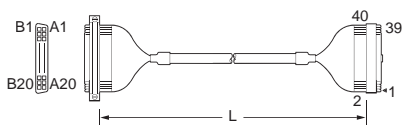

Wiring Diagram

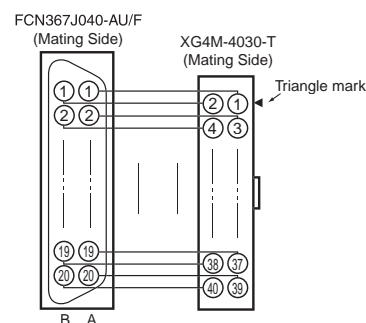

XW2Z-□□□FF-L

MIL 40-pin – MIL 40-pin, Straight Wiring

Appearance	Model	Cable length L (m)	Sheath outer diameter (mm)/ Minimum bending radius (mm)
	XW2Z-0050FF-L	0.5	8.2 dia./R66
	XW2Z-0100FF-L	1	
	XW2Z-0150FF-L	1.5	
	XW2Z-0200FF-L	2	
	XW2Z-0300FF-L	3	
	XW2Z-0500FF-L	5	
	XW2Z-0700FF-L	7	
	XW2Z-1000FF-L	10	

Cable length L (m)

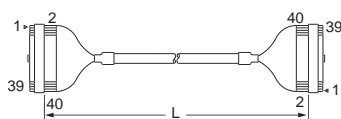

Wiring Diagram

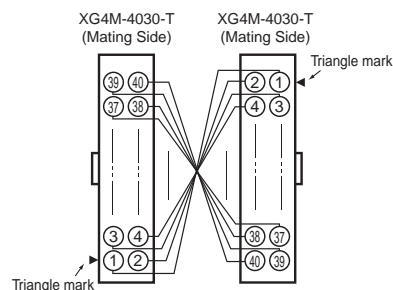

Note: Wire the pins 1:1 so that the Connector pin numbers match.

For PLC Connection

For PLC Connection (Integrated Common Terminal Type)

General-Purpose

Common Terminal Blocks

Common Items for Terminal Blocks

Cable (Shielded)

Cable (Unshielded)

Terms and Conditions Agreement

Read and understand this catalog.

Please read and understand this catalog before purchasing the products. Please consult your OMRON representative if you have any questions or comments.

Warranties.

- (a) Exclusive Warranty. Omron's exclusive warranty is that the Products will be free from defects in materials and workmanship for a period of twelve months from the date of sale by Omron (or such other period expressed in writing by Omron). Omron disclaims all other warranties, express or implied.
- (b) Limitations. OMRON MAKES NO WARRANTY OR REPRESENTATION, EXPRESS OR IMPLIED, ABOUT NON-INFRINGEMENT, MERCHANTABILITY OR FITNESS FOR A PARTICULAR PURPOSE OF THE PRODUCTS. BUYER ACKNOWLEDGES THAT IT ALONE HAS DETERMINED THAT THE PRODUCTS WILL SUITABLY MEET THE REQUIREMENTS OF THEIR INTENDED USE.

Omron further disclaims all warranties and responsibility of any type for claims or expenses based on infringement by the Products or otherwise of any intellectual property right. (c) Buyer Remedy. Omron's sole obligation hereunder shall be, at Omron's election, to (i) replace (in the form originally shipped with Buyer responsible for labor charges for removal or replacement thereof) the non-complying Product, (ii) repair the non-complying Product, or (iii) repay or credit Buyer an amount equal to the purchase price of the non-complying Product; provided that in no event shall Omron be responsible for warranty, repair, indemnity or any other claims or expenses regarding the Products unless Omron's analysis confirms that the Products were properly handled, stored, installed and maintained and not subject to contamination, abuse, misuse or inappropriate modification. Return of any Products by Buyer must be approved in writing by Omron before shipment. Omron Companies shall not be liable for the suitability or unsuitability or the results from the use of Products in combination with any electrical or electronic components, circuits, system assemblies or any other materials or substances or environments. Any advice, recommendations or information given orally or in writing, are not to be construed as an amendment or addition to the above warranty.

See <http://www.omron.com/global/> or contact your Omron representative for published information.

Limitation on Liability; Etc.

OMRON COMPANIES SHALL NOT BE LIABLE FOR SPECIAL, INDIRECT, INCIDENTAL, OR CONSEQUENTIAL DAMAGES, LOSS OF PROFITS OR PRODUCTION OR COMMERCIAL LOSS IN ANY WAY CONNECTED WITH THE PRODUCTS, WHETHER SUCH CLAIM IS BASED IN CONTRACT, WARRANTY, NEGLIGENCE OR STRICT LIABILITY.

Further, in no event shall liability of Omron Companies exceed the individual price of the Product on which liability is asserted.

Suitability of Use.

Omron Companies shall not be responsible for conformity with any standards, codes or regulations which apply to the combination of the Product in the Buyer's application or use of the Product. At Buyer's request, Omron will provide applicable third party certification documents identifying ratings and limitations of use which apply to the Product. This information by itself is not sufficient for a complete determination of the suitability of the Product in combination with the end product, machine, system, or other application or use. Buyer shall be solely responsible for determining appropriateness of the particular Product with respect to Buyer's application, product or system. Buyer shall take application responsibility in all cases.

NEVER USE THE PRODUCT FOR AN APPLICATION INVOLVING SERIOUS RISK TO LIFE OR PROPERTY OR IN LARGE QUANTITIES WITHOUT ENSURING THAT THE SYSTEM AS A WHOLE HAS BEEN DESIGNED TO ADDRESS THE RISKS, AND THAT THE OMRON PRODUCT(S) IS PROPERLY RATED AND INSTALLED FOR THE INTENDED USE WITHIN THE OVERALL EQUIPMENT OR SYSTEM.

Programmable Products.

Omron Companies shall not be responsible for the user's programming of a programmable Product, or any consequence thereof.

Performance Data.

Data presented in Omron Company websites, catalogs and other materials is provided as a guide for the user in determining suitability and does not constitute a warranty. It may represent the result of Omron's test conditions, and the user must correlate it to actual application requirements. Actual performance is subject to the Omron's Warranty and Limitations of Liability.

Change in Specifications.

Product specifications and accessories may be changed at any time based on improvements and other reasons. It is our practice to change part numbers when published ratings or features are changed, or when significant construction changes are made. However, some specifications of the Product may be changed without any notice. When in doubt, special part numbers may be assigned to fix or establish key specifications for your application. Please consult with your Omron's representative at any time to confirm actual specifications of purchased Product.

Errors and Omissions.

Information presented by Omron Companies has been checked and is believed to be accurate; however, no responsibility is assumed for clerical, typographical or proofreading errors or omissions.

Note: Do not use this document to operate the Unit.

OMRON Corporation Industrial Automation Company

Kyoto, JAPAN

Contact : www.ia.omron.com

Regional Headquarters

OMRON EUROPE B.V.

Wegalaan 67-69, 2132 JD Hoofddorp
The Netherlands
Tel: (31) 2356-81-300 Fax: (31) 2356-81-388

OMRON ELECTRONICS LLC

2895 Greenspoint Parkway, Suite 200
Hoffman Estates, IL 60169 U.S.A.
Tel: (1) 847-843-7900 Fax: (1) 847-843-7787

OMRON ASIA PACIFIC PTE. LTD.

438B Alexandra Road, #08-01/02 Alexandra
Technopark, Singapore 119968
Tel: (65) 6835-3011 Fax: (65) 6835-2711

OMRON (CHINA) CO., LTD.

Room 2211, Bank of China Tower,
200 Yin Cheng Zhong Road,
PuDong New Area, Shanghai, 200120, China
Tel: (86) 21-5037-2222 Fax: (86) 21-5037-2200

Authorized Distributor:

©OMRON Corporation 2022-2023 All Rights Reserved.
In the interest of product improvement,
specifications are subject to change without notice.

CSM_1_4

Cat. No. G152-E1-04 0123 (0422)