

Machine Automation Controller NJ-series

General-purpose Serial Connection Guide (RS-485 CompoWay/F) OMRON Corporation

KM1-series Smart Power Monitor/
KE1-series Smart Measurement and
Monitoring Instrument

Network
Connection
Guide

About Intellectual Property Right and Trademarks

Microsoft product screen shots reprinted with permission from Microsoft Corporation.

Windows is a registered trademark of Microsoft Corporation in the United States and other countries.

EtherCAT® is registered trademark and patented technology, licensed by Beckhoff Automation GmbH, Germany.

Company names and product names in this document are the trademarks or registered trademarks of their respective companies.

Table of Contents

1. Related Manuals	1
2. Terms and Definitions	1
3. Remarks	2
4. Overview	4
5. Applicable Devices and Support Software.....	5
5.1. Applicable Devices.....	5
5.2. Device Configuration.....	6
6. Serial Communications Settings	8
6.1. Serial Communications Settings	8
6.2. Cable Wiring Diagram	9
6.3. Example of Checking Connection	10
7. Connection Procedure	11
7.1. Work Flow	11
7.2. Setting Up the Smart Power Monitor.....	12
7.3. Setting Up the Controller.....	20
7.4. Checking the Serial Communications	34
8. Initialization Method	37
8.1. Initializing the Controller.....	37
8.2. Initializing the Smart Power Monitor.....	38
9. Program.....	39
9.1. Overview	39
9.2. Destination Device Command.....	44
9.3. Error Detection Processing	47
9.4. Variables	48
9.5. ST Program.....	50
9.6. Timing Charts.....	58
9.7. Error Process	59
10. Revision History	63

1. Related Manuals

The table below lists the manuals related to this document.

To ensure system safety, make sure to always read and heed the information provided in all Safety Precautions, Precautions for Safe Use, and Precaution for Correct Use of manuals for each device which is used in the system.

Cat.No	Model	Manual name
W500	NJ501-□□□□ NJ301-□□□□	NJ-series CPU Unit Hardware User's Manual
W501	NJ501-□□□□ NJ301-□□□□	NJ-series CPU Unit Software User's Manual
W494	CJ1W-SCU□2	CJ-series Serial Communications Units Operation Manual for NJ-series CPU Unit
W502	NJ501-□□□□ NJ301-□□□□	NJ-series Instructions Reference Manual
W504	SYSMAC-SE2□□□□	Sysmac Studio Version 1 Operation Manual
N172	KM1/KE1	Smart Power Monitor Communication Manual for Smart Measurement and Monitoring Instrument
N171	KM1	Smart Power Monitor User's Manual
GAMS-010	KM1/KE1	KM1/KE1-Setting User's Manual



2. Terms and Definitions

Term	Explanation and Definition
Serial Gateway Mode	The receive message is automatically converted to CompoWay/F, Modbus-RTU, or Modbus-ASCII according to the message.

3. Remarks

- (1) Understand the specifications of devices which are used in the system. Allow some margin for ratings and performance. Provide safety measures, such as installing safety circuit in order to ensure safety and minimize risks of abnormal occurrence.
- (2) To ensure system safety, always read and heed the information provided in all Safety Precautions, Precautions for Safe Use, and Precaution for Correct Use of manuals for each device used in the system.
- (3) The user is encouraged to confirm the standards and regulations that the system must conform to.
- (4) It is prohibited to copy, to reproduce, and to distribute part of or the whole part of this document without the permission of OMRON Corporation.
- (5) The information contained in this document is current as of June 2013. It is subject to change without notice for improvement.

The following notation is used in this document.

 WARNING	Indicates a potentially hazardous situation which, if not avoided, will result in minor or moderate injury, or may result in serious injury or death. Additionally there may be significant property damage.
 Caution	Indicates a potentially hazardous situation which, if not avoided, may result in minor or moderate injury or in property damage.



Precautions for Safe Use

Precautions on what to do and what not to do to ensure safe usage of the product



Precautions for Correct Use

Precautions on what to do and what not to do to ensure proper operation and performance.



Additional Information

Additional information to read as required.

This information is provided to increase understanding or make operation easier

Symbol



The filled circle symbol indicates operations that you must do.
 The specific operation is shown in the circle and explained in text.
 This example shows a general precaution for something that you must do.

4. Overview

This document describes the procedure for connecting the Smart Power Monitor/Smart Measurement and Monitoring Instrument (KM1/KE1) of OMRON Corporation (hereinafter referred to as OMRON) with the NJ-series Machine Automation Controller (hereinafter referred to as Controller) via serial communications, and describes the procedure for checking their connection.

Refer to the serial communications settings of the prepared Sysmac Studio project file and understand the setting method and key points to connect the devices via serial communications.

The user program in this project file is used to check the serial connection by executing the CompoWay/F command on the destination device.

Prepare the latest Sysmac Studio project file beforehand. To obtain the file, contact your OMRON representative.

Name	File name	Version
Sysmac Studio project file (extension: smc)	OMRON_CWF485_EV100.smc	Ver.1.00

*Hereinafter, the Sysmac Studio project file is referred to as the “project file”.

The user program in the project file is referred to as the “program”.

Caution

This document aims to explain the wiring method and communications settings necessary to connect the corresponding devices and provide the setting procedure. The program used in this document is designed to check if the connection was properly established, and is not designed to be constantly used at a site. Therefore, functionality and performances are not sufficiently taken into consideration. When you construct an actual system, please use the wiring method, communications settings and setting procedure described in this document as a reference and design a new program according to your application needs.



5. Applicable Devices and Support Software

5.1. Applicable Devices

The applicable devices are as follows:

Manufacturer	Name	Model
OMRON	NJ-series CPU Unit	NJ501-□□□□□ NJ301-□□□□□
OMRON	Serial Communications Unit	CJ1W-SCU□2
OMRON	Smart Power Monitor Smart Measurement and Monitoring Instrument	KM1-□□□□□-FLK KE1-□□□□□-FLK



Precautions for Correct Use

As applicable devices above, the devices with the models and versions listed in Section 5.2. are actually used in this document to describe the procedure for connecting devices and checking the connection.

You cannot use devices with versions lower than the versions listed in Section 5.2.

To use the above devices with versions not listed in Section 5.2 or versions higher than those listed in Section 5.2, check the differences in the specifications by referring to the manuals before operating the devices.



Additional Information

This document describes the procedure to establish the network connection. Except for the connection procedure, it does not provide information on operation, installation or wiring method. It also does not describe the function or operation of the devices. Refer to the manuals or contact your OMRON representative.

5.2. Device Configuration

The hardware components to reproduce the connection procedure of this document are as follows:

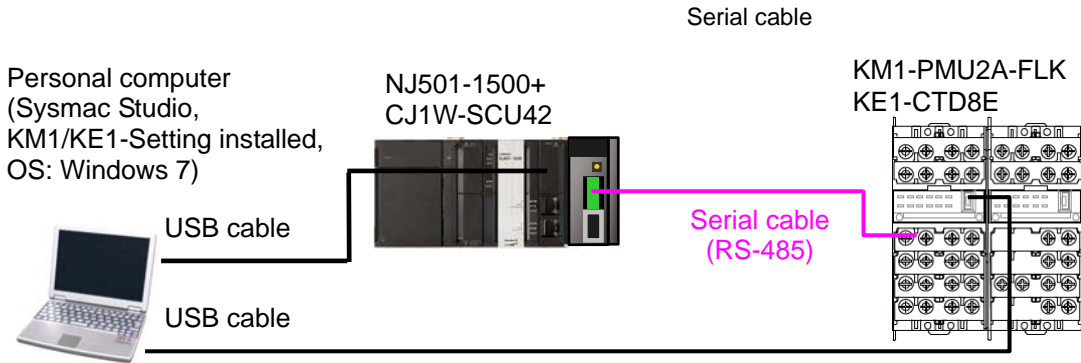

Manufacturer	Name	Model	Version
OMRON	Serial Communications Unit	CJ1W-SCU42	Ver.2.0
OMRON	NJ-series CPU Unit	NJ501-1500	Ver.1.03
OMRON	Power Supply Unit	NJ-PA3001	
OMRON	Sysmac Studio	SYSMAC-SE2[] [] [] []	Ver.1.04
OMRON	Sysmac Studio project file	OMRON_CWF485_EV10 0.smc	Ver.1.00
-	Personal computer (OS:Windows7)	-	
-	USB cable (USB 2.0 type B connector)	-	
-	USB cable (USB 2.0 mini-B connector)	-	
-	Serial cable (RS-485)	-	
OMRON	Smart Power Monitor	KM1-PMU2A-FLK	
OMRON	CT Expansion Slave Unit	KE1-CTD8E	
OMRON	KM1/KE1-Setting	-	

Precautions for Correct Use

- Prepare the latest project file in advance.
- To obtain the file, contact your OMRON representative.

Precautions for Correct Use

Update the Sysmac Studio to the version specified in this section or higher version using the auto update function. If a version not specified in this section is used, the procedures described in Section 7 and subsequent sections may not be applicable. In that case, use the equivalent procedures described in the Sysmac Studio Version 1 Operation Manual (Cat.No. W504).



Additional Information

It may not be possible to reproduce the same operation with different devices or versions. Check the configuration, model and version. If they are different from your configuration. Contact your OMRON representative.



Additional Information

For information on the serial cable (RS-485), refer to *3-3 RS-232C and RS-422A/485 Wiring* in the *CJ-series Serial Communications Units Operation Manual for NJ-series CPU Unit* (Cat.No. W494).



Additional Information

The system configuration in this document uses USB for the connection between the personal computer and the Controller. For information on how to install the USB driver, refer to *A-1 Driver Installation for Direct USB Cable Connection* of the *Sysmac Studio Version 1 Operation Manual* (Cat.No. W504).



Additional Information

The system configuration in this document uses USB for the connection between the personal computer and the Smart Power Monitor. For information on how to install the USB driver, refer to *3.1. Installation* in the *KM1/KE1-Setting User's Manual* (Cat. No. GAMS-010).

6. Serial Communications Settings

This section provides the specifications such as the cable wiring and communications parameters that are set in this document.



Additional Information

To perform communications without using the settings described in this section, you need to modify the program. For information on the program, refer to *Section 9. Program*.

6.1. Serial Communications Settings

The settings for serial communications are shown below.

Setting item	Serial Communications Unit	Smart Power Monitor
Device name	J01	-
Unit number	0	-
Unit number (Node No.)	-	1 (Default)
Communications (connection) port	Port 1 (RS-422/485)	-
TERM (Terminating resistance ON/OFF switch)	ON (Terminating resistance ON)	-
WIRE (2-wire or 4-wire selector switch)	2 (2-wire)	2-wire (Fixed)
Serial communications mode	Serial Gateway	-
Data length (Transmission characters)	7 bits (Default)	7 bits (Default)
Stop bit	2 bits (Default)	2 bits (Default)
Parity (Parity bit)	Even (Default)	Even (Default)
Baud rate (Transmission speed)	9,600 bps (Default)	9,600 bps (Default)
Switch communications protocol	-	OFF (CompoWay/F)
Send wait time	-	20ms (Default)

Setting item	CT Expansion Slave Unit
SLAVE ID (Rotary switch)	1
Unit No. (Node No.)	2



Precautions for Correct Use

This document describes the procedure for setting the CJ1W-SCU42 Serial Communications Unit when the unit number 0, communications port 1 and device name J01 are used. To connect devices under different conditions, refer to *9. Program* and create a program by changing the variable names and setting values.

6.2. Cable Wiring Diagram

For details on the cable wiring, refer to *Section 3 Installation and Wiring* of the *CJ-series Serial Communications Units Operation Manual for NJ-series CPU Unit* (Cat. No. W494) and *2.5 Wiring of the Smart Power Monitor User's Manual* (Cat. No. N171). Check the connector configuration and pin assignment for wiring.

■ Connector configuration and pin assignment

<OMRON CJ1W-SCU42> Applicable connector: Terminal block

Pin No.	Symbol	Signal name	I/O
1 (See note 1.)	RDA	Receive data -	Input
2 (See note 1.)	RDB	Receive data +	Input
3 (See note 1.)	SDA	Send data -	Output
4 (See note 1.)	SDB	Send data +	Output
5 (See note 2.)	FG	Shield	---

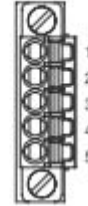

- Note**
1. For 2-wire connections, use either pins 1 and 2 or pins 3 and 4.
 2. Pin 5 (the shield) is connected to the GR terminal on the Power Supply Unit though the Serial Communications Unit. The cable shield can thus be grounded by grounding the GR terminal of the Power Supply Unit.

<KM1/KE1> Applicable connector: Terminal block

Pin No.	Signal name	Input/Output
1-6		
7	A(-)	Input/Output
8	B(+)	Input/Output
9-24		

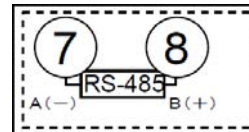

■ Cable/Pin arrangement

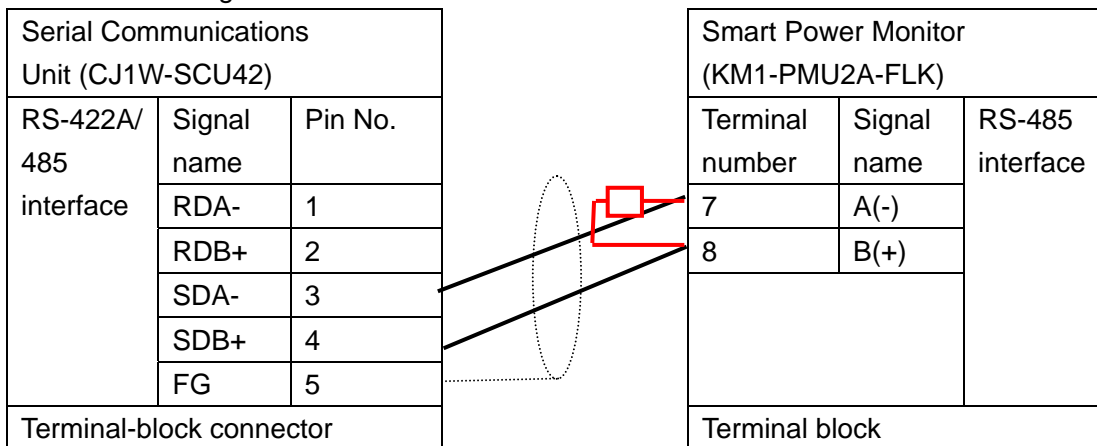

Precautions for Correct Use

Turn ON the terminating resistance switch on the Serial Communications Unit and connect an external resistor of 120Ω (1/2W) to the Smart Power Monitor that is connected at the end of the network as shown in the Cable/Pin arrangement above.

6.3. Example of Checking Connection

This document shows an example of an ST (structured text) program in which the Controller sends/receives the CompoWay/F message to/from the Smart Power Monitor.

The Controller and Smart Power Monitor send and receive the message of "Read Unit Attributes". The following figure outlines the operation.

●Outline of operation

- (1)The ST program is used to execute the command send instruction (SendCmd instruction) that specifies the CompoWay/F protocol to send and receive the message of "Read Unit Attributes".
- (2)The corresponding message is converted to CompoWay/F protocol and the converted data is sent to the Smart Power Monitor.
- (3)The Smart Power Monitor executes the command corresponding to the send data from the Controller.
- (4)The Controller receives the execution result of the command and stores it in the specified variable.

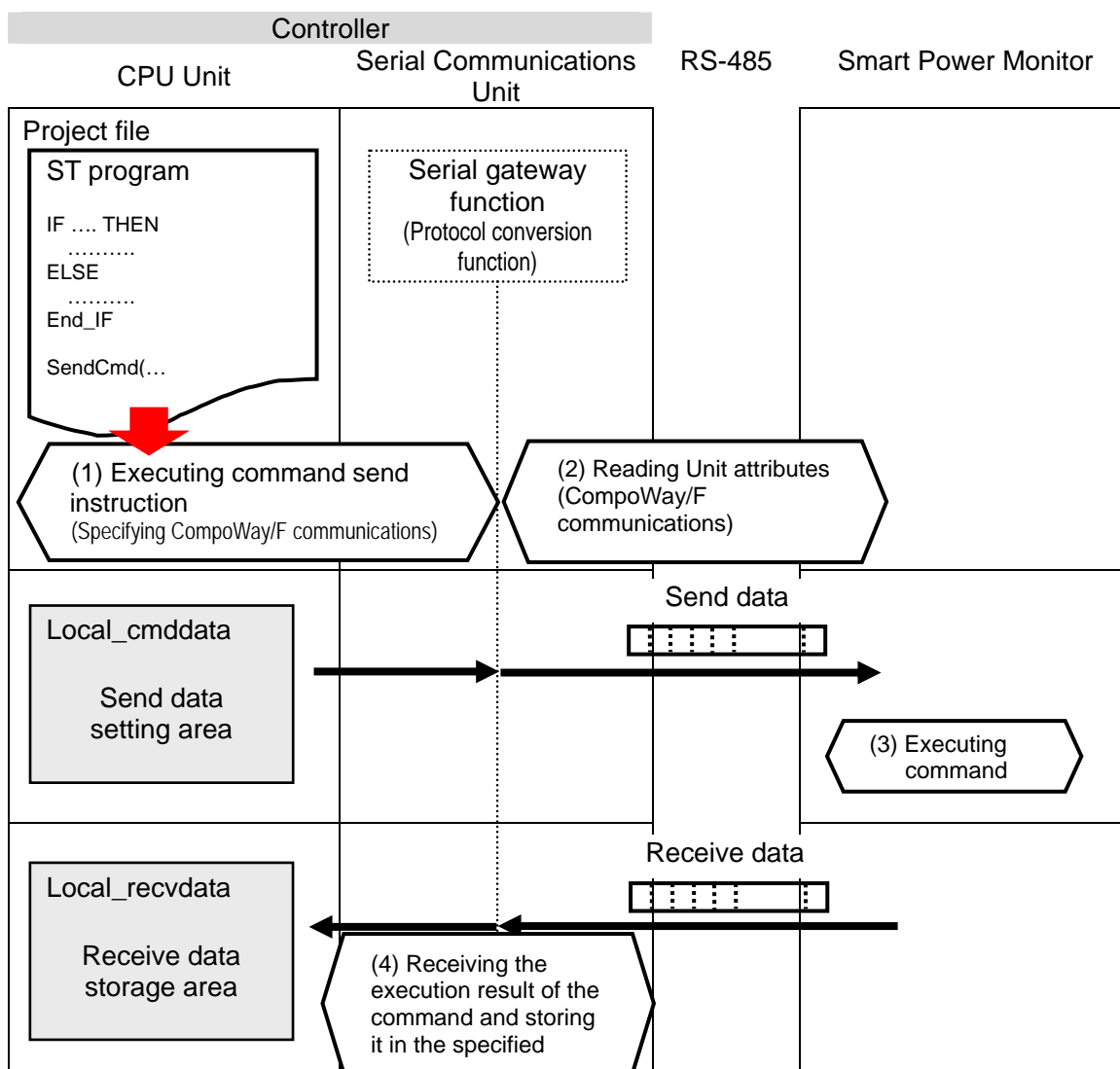

7. Connection Procedure

This section describes the procedure for connecting the Smart Power Monitor to the Controller via serial communications.

This document explains the procedures for setting up the Controller and Smart Power Monitor from the factory default setting. For the initialization, refer to *Section 8 Initialization Method*.

7.1. Work Flow

Take the following steps to connect the Smart Power Monitor to the Controller via serial communications.

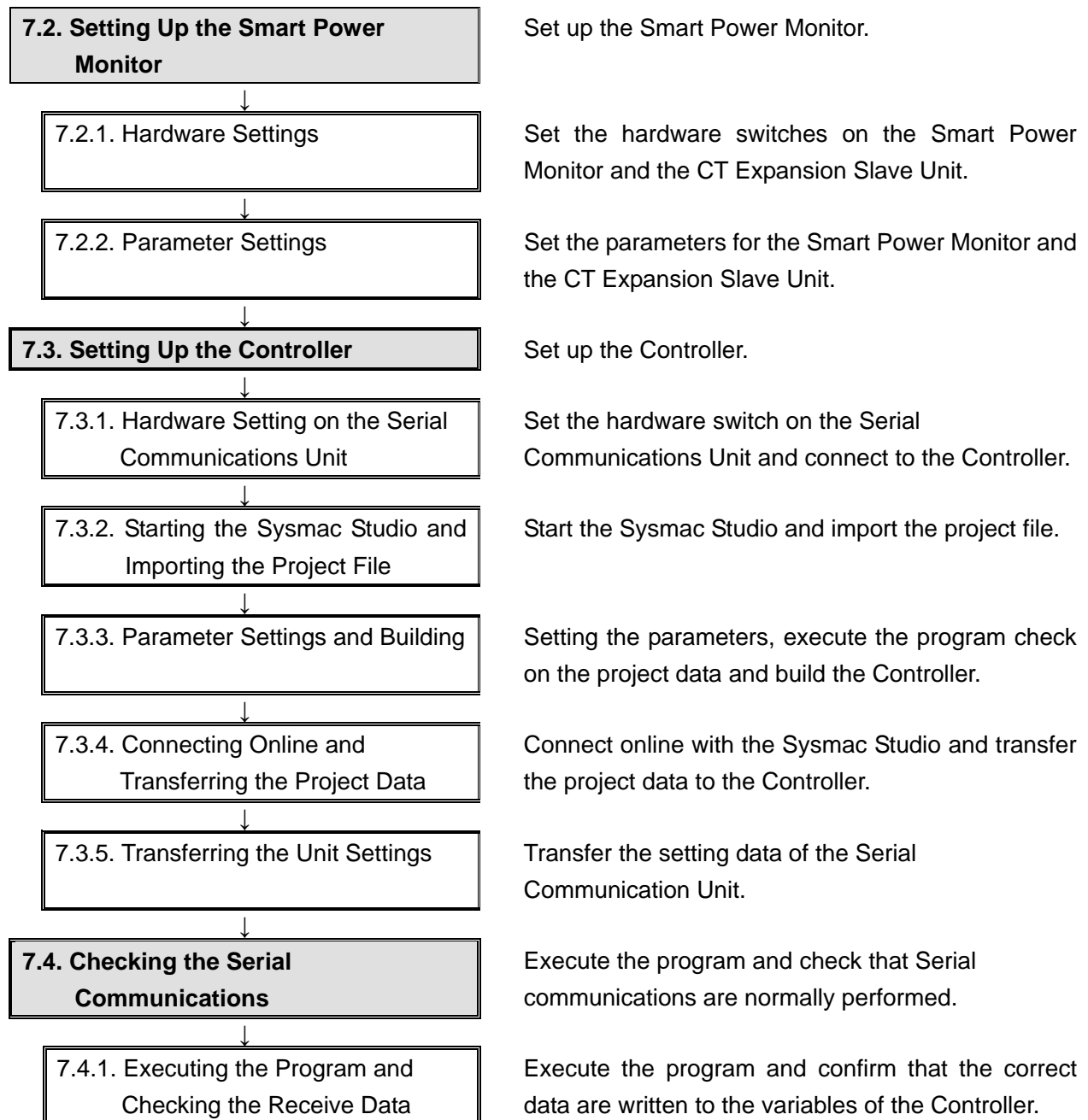

7.2. Setting Up the Smart Power Monitor

Set up the Smart Power Monitor.

7.2.1. Hardware Setting

Set the hardware switches on the Smart Power Monitor and the CT Expansion Slave Unit.



Precautions for Correct Use

Make sure that the power supply is OFF when you perform the setting up.

- 1 Make sure that the power supply to the Smart Power Monitor is OFF.

*If the power supply is turned ON, settings may not be applicable as described in the following procedure.

- 2 Open the connector cover of the Smart Power Monitor and the CT Expansion Slave Unit. Set No. 2 of each internal DIP switch to OFF (CompoWay/F).

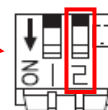
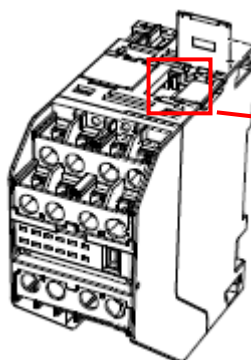

DIPswitch

Instead of Switch 1, use Switch 2 to change the communication protocol.

Switch 2: **OFF** CompoWay/F
ON Modbus

- 3 Set the rotary switch (SLAVE ID) in the connector cover of the CT Expansion Slave Unit to 1.

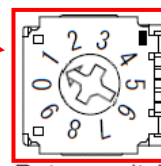
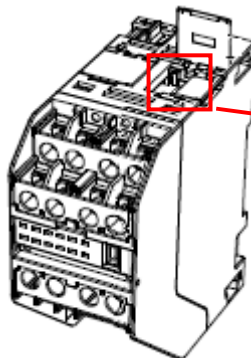

Rotary switch

The slave ID should be set without overlapping among 1 to 4.

4 Connect the CT Expansion Slave Unit to the Smart Power Monitor.

(1) Connect the horizontally connecting hook.

Slide the white, horizontally connecting hooks on top and at the bottom of the product until a clicking sound is heard and lock.

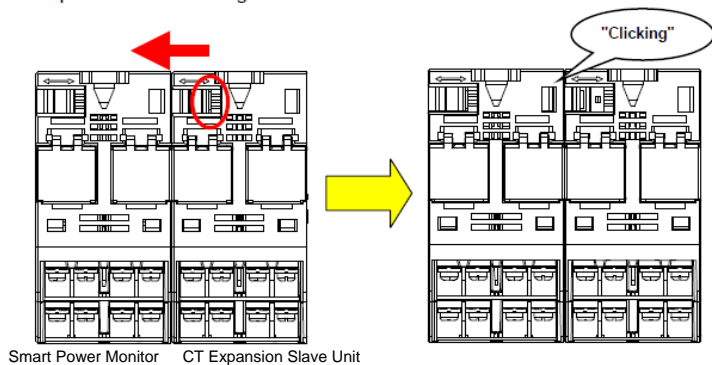

(2) Install the connector.

Lift the cover on top of the product and set the connection connector. Close the cover before use.

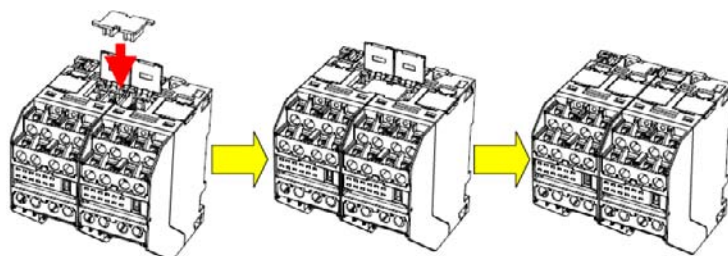

5 Connect the serial cable to pins 7 and 8 of the Smart Power Monitor. Connect the power supply cable to pins 1 and 2.

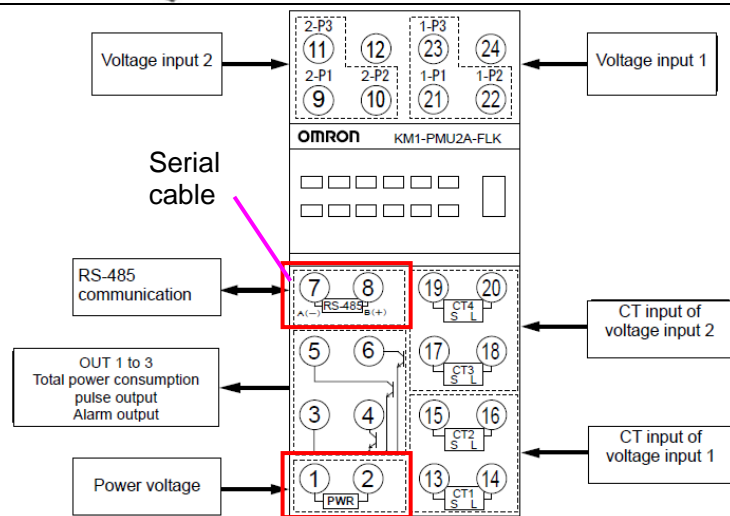

6 Connect the USB cable to the USB port on the CT Expansion Slave Unit. **Do not connect the other end of the USB cable to the personal computer. (Connect it in step 2 of Section 7.2.2.)**

Turn ON the power supply to the Smart Power Monitor.

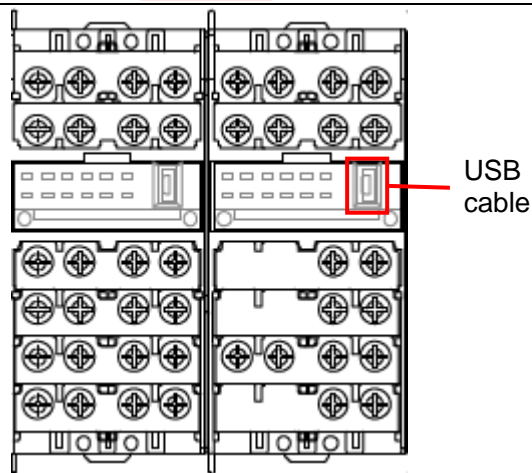

7.2.2. Parameter Settings

Set the parameters for the Smart Power Monitor and the CT Expansion Slave Unit.
To set the parameters by using the KM1/KE1-Setting, install the software and the driver in the personal computer in advance.



Additional Information

For how to install the software and the driver, refer to 3.1. *Installation of the KM1/KE1-Setting User's Manual* (Cat. No. GAMS-010).

- 1 Start the KM1/KE1-Setting.

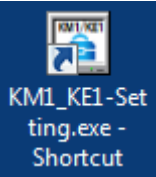
- 2 The Connection method Dialog Box is displayed.

Connect the USB cable to the personal computer.

Select the USB connection option and click the **OK** Button.

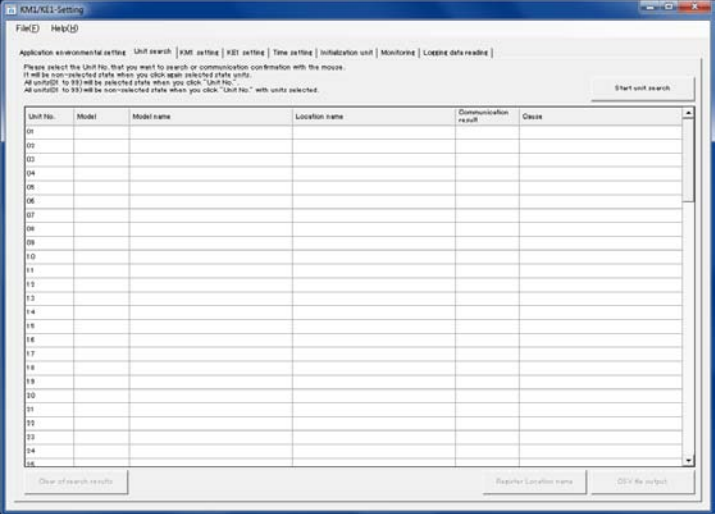

- 3 The KM1/KE1-Setting Window is displayed.



4 Select the Application environmental setting Tab. Select the USB connection Option for Connection method and select the used communication port for USB virtual COM port No.

*If the personal computer has multiple serial ports, display the Windows' Device Manager and find the COM port number, to which the KM1/KE1 is connected, under Ports (COM & LPT). (COM 16 is set in the right example.)

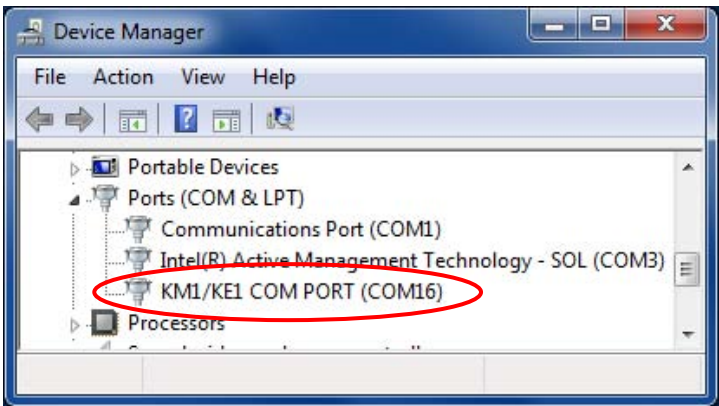
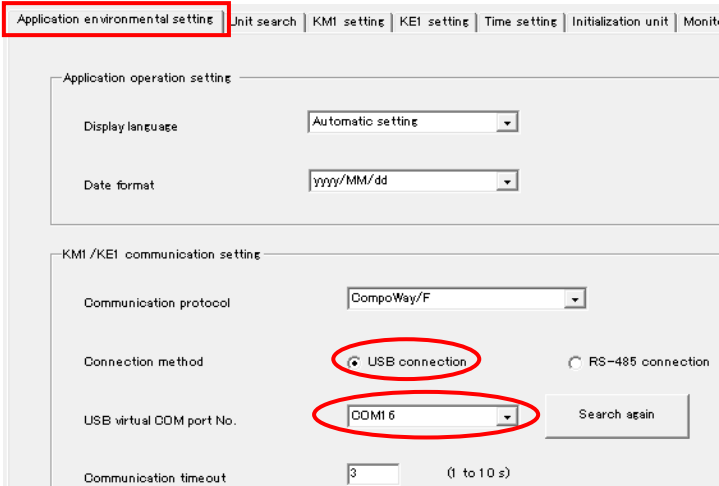
*To open Device Manager, select **Device Manager** from Control Panel.



5 Select the Unit search Tab. Select 01 under the Unit No. Column. The selected item is highlighted. Click the **Start unit search** Button.

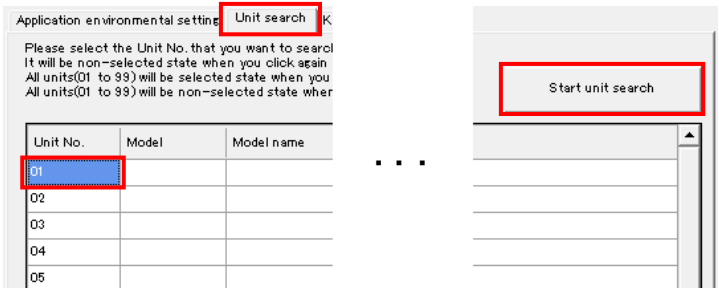

6 A confirmation dialog box is displayed. Click the **Yes** Button.

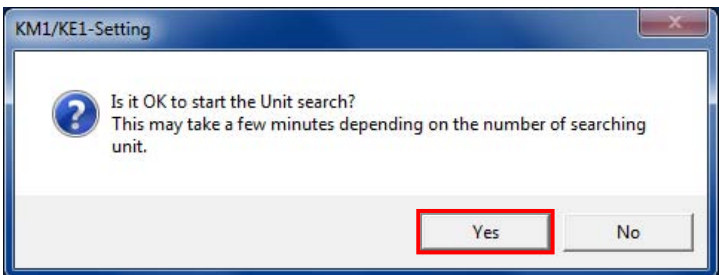

- 7 When a message indicating the searching is being performed disappears, a confirmation dialog box is displayed. Click the **OK** Button.

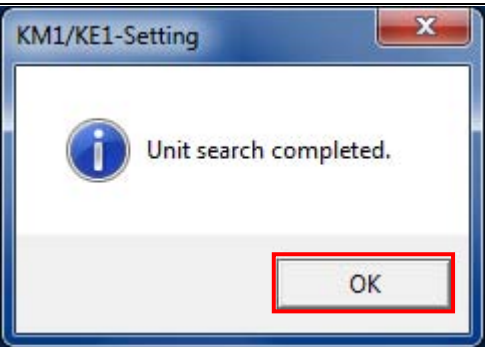

- 8 Confirm that the connected device is displayed in the row of Unit No. 01 and that the communication result is "Passed".

*If the communication result is "Failed", an incorrect Unit No. is set. To check the current number, click the **Clear of search results** Button and select all Unit No. Columns. Then, click the **Start unit search** Button. Select a Unit No. whose communication result is "Passed" and follow the steps below.

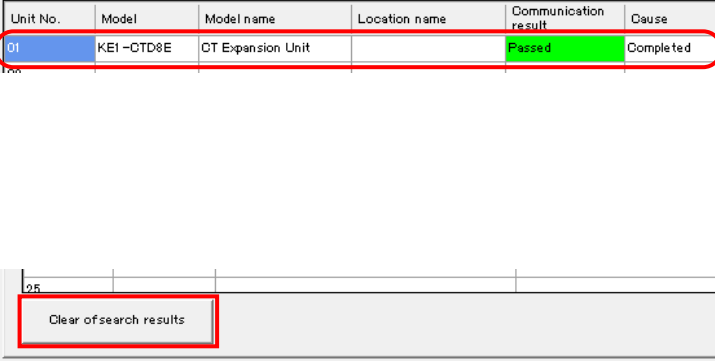
Unit No.	Model	Model name	Location name	Communication result	Cause
01	KE1-CTD8E	CT Expansion Unit		Passed	Completed

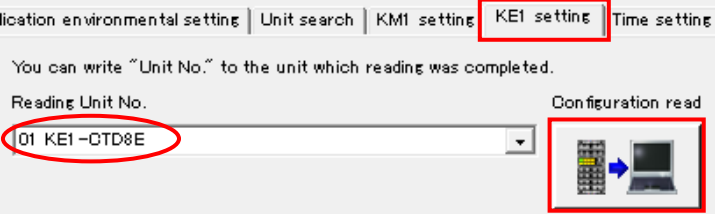
- 9 Select the KE1 setting Tab. Confirm that the target device is shown in the Reading Unit No. Field and click the **Configuration read** Button.

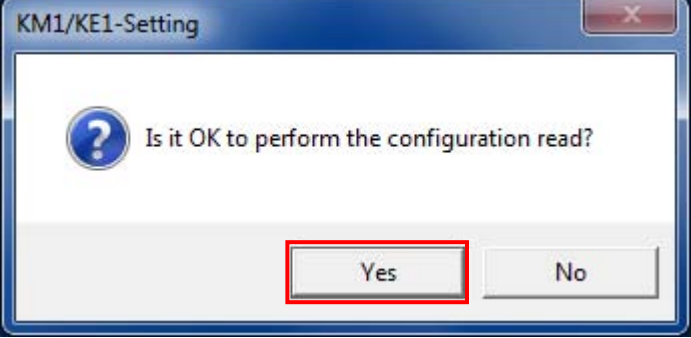
- 10 A confirmation dialog box is displayed. Click the **Yes** Button.



11 Select the Communication setting Tab. Check the Unit No. If the value is different from the value (02) specified in Section 6.1, use the following procedure.

Select 02 from the pull-down list of Unit No.

*The setting range of Unit No. is 0 to 99. Set a value. (02 is set in this document.) The set value must not be duplicated between units.

The value of Unit No. changes to 02. The new value is displayed in red.

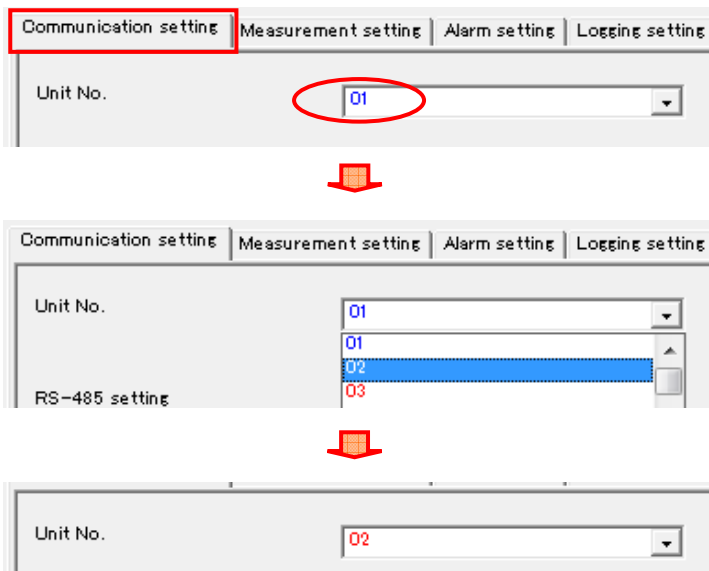

12 Confirm that the target device is displayed in the Writing Unit No. Field and click the Configuration write Button.

A confirmation dialog box is displayed. Click the Yes Button.

The Waiting for restart unit... Dialog Box is displayed. When the dialog box is closed, the rewrite operation is completed.

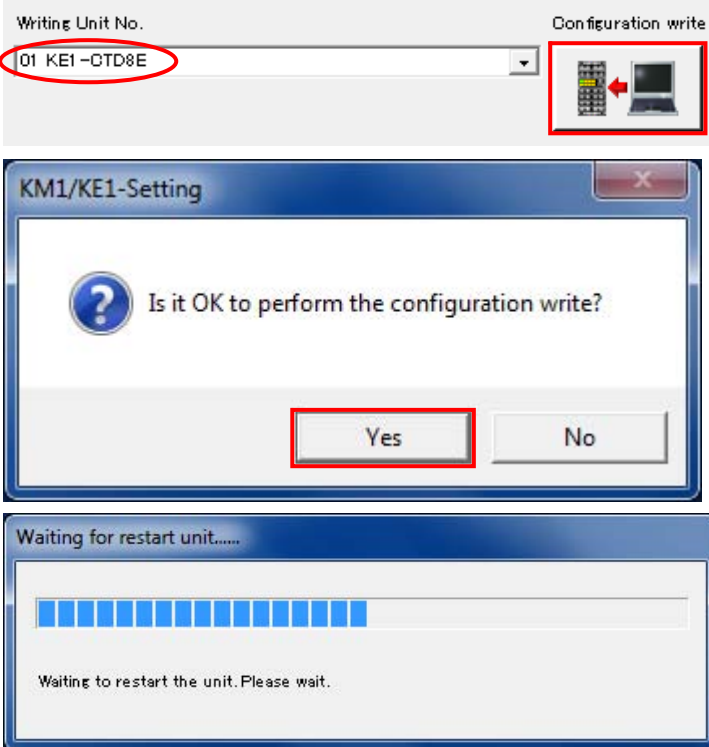

13 Select the Unit search Tab. Select the Unit No. that "Passed" in step 8 (here, 01 is selected.) and select 02 under the Unit No. Column. The selected items are highlighted as shown on the right.

Click the Start unit search Button.

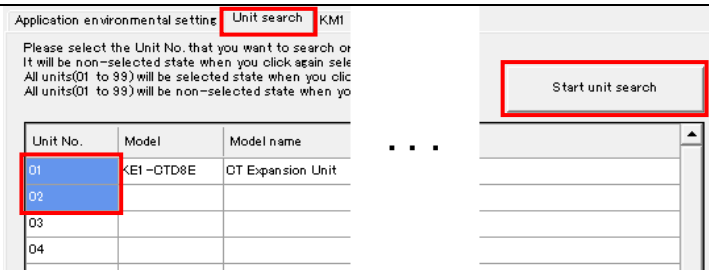

14 A confirmation dialog box is displayed. Click the **Yes** Button and **OK** Button.

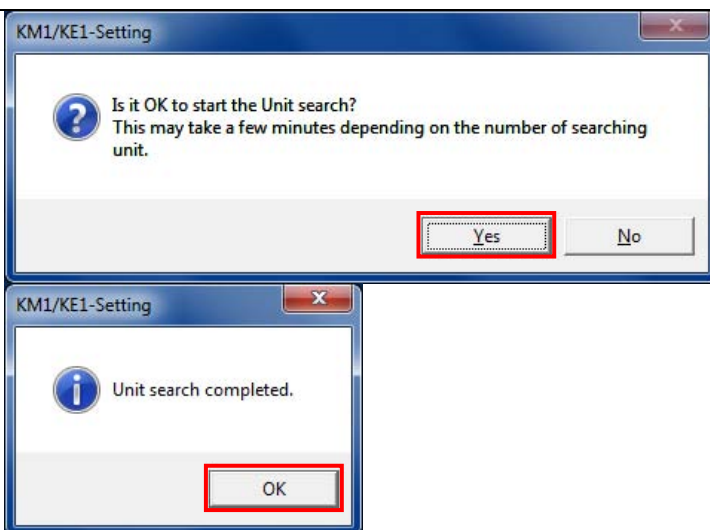

15 Confirm that the connected device name (CT Expansion Unit) is displayed in the row of Unit No. 02 and that the communication result is "Passed".

Unit No.	Model	Model name	Location name	Communication result	Cause
01	KE1-CTD8E	CT Expansion Unit		Failed	No response
02	KE1-CTD8E	CT Expansion Unit		Passed	Completed

*If the communication result is "Failed", the Unit No. is not correctly set. Return to step 8 and perform the settings again.

16 Remove the USB cable that is connected to the USB port on the CT Expansion Slave Unit, and connect it to the USB port on the Smart Power Monitor.

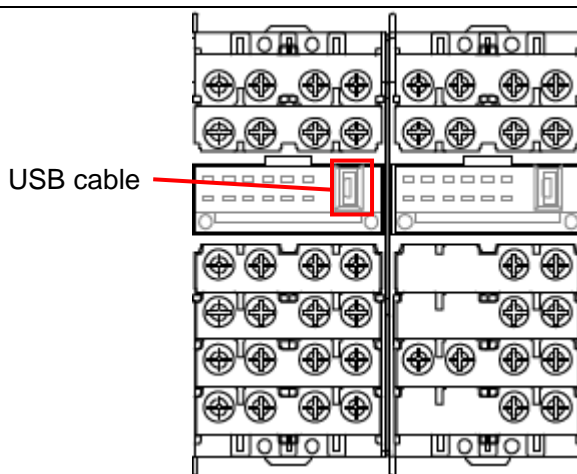

17 In the same way as steps 13 and 14, select Unit No. 01 and 02 in the Unit search Tab and click the **Start unit search** Button.

(Refer to steps 13 and 14.)

18 Confirm that the connected device (Power Two-System Measurement Unit) is displayed in the row of Unit No. 01 and that the communication result is "Passed".

Unit No.	Model	Model name	Location name	Communication result	Cause
01	KMI-FMU2A	Power Two-System Measurement Unit		Passed	Completed
02	KE1-CTD8E	CT Expansion Unit		Failed	No response

<p>19</p>	<p>Select the KM1 setting Tab. Confirm that the target device is displayed in the Reading Unit No. Field, and click the Configuration read Button.</p>	
<p>20</p>	<p>A configuration dialog box is displayed. Click the Yes Button.</p>	
<p>21</p>	<p>Confirm that the values specified in Section 6.1. are displayed in the Communication setting Tab Page as shown on the right.</p> <p>*If the values are different, change a value from each pull-down list and click the Configuration read Button to write the changes.</p>	
<p>22</p>	<p>Select Exit from the File Menu. A confirmation dialog box is displayed. Click the Yes Button.</p>	

7.3. Setting Up the Controller

Set up the Controller.

7.3.1. Hardware Settings on the Serial Communications Unit

Set the hardware switches on the Serial Communications Unit.



Precautions for Correct Use

Make sure that the power supply is OFF when you perform the setting up.

<p>1</p> <p>Make sure that the power supply to the Controller is OFF.</p> <p>*If the power supply is turned ON, settings may not be applicable as described in the following procedure.</p> <p>Check the each part name by referring to the right figure.</p> <p>*This setting is required to use the Port 1 of Serial Communications Unit.</p>	<p>CJ1W-SCU42</p>	
<p>2</p> <p>Set the Unit number switch to 0. (The unit number is set to 0 as the factory default setting.)</p>		<p>Unit number switch</p>
<p>3</p> <p>Set the terminating resistance ON/OFF switch of port 1 to ON (Terminating resistance ON).</p>		<p>TERM:terminating resistance ON/OFF switch OFF:Terminating resistance OFF ON:Terminating resistance ON</p>
<p>4</p> <p>Set the 2-wire or 4-wire selector switch for port 1 to 2 (2-wire).</p>		<p>WIRE:2-wire/4-wire switch 2:2-wire;4:4-wire</p>

5 Connect the Serial Communications Unit to the Controller as shown on the right. Connect the Smart Power Monitor and the Serial Communications Unit with the serial cable. Connect the Controller and the personal computer with the USB cable.

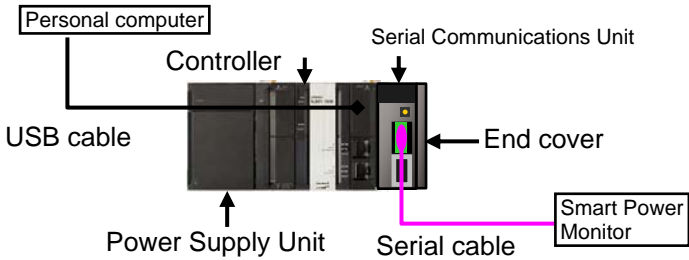

7.3.2. Starting the Sysmac Studio and Importing the Project File

Start the Sysmac Studio and import the project file.

Install the Sysmac Studio and USB driver in the personal computer in advance.

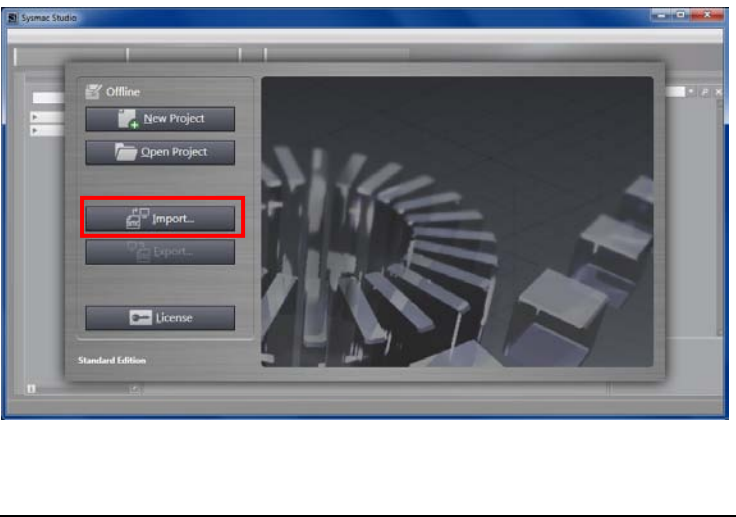
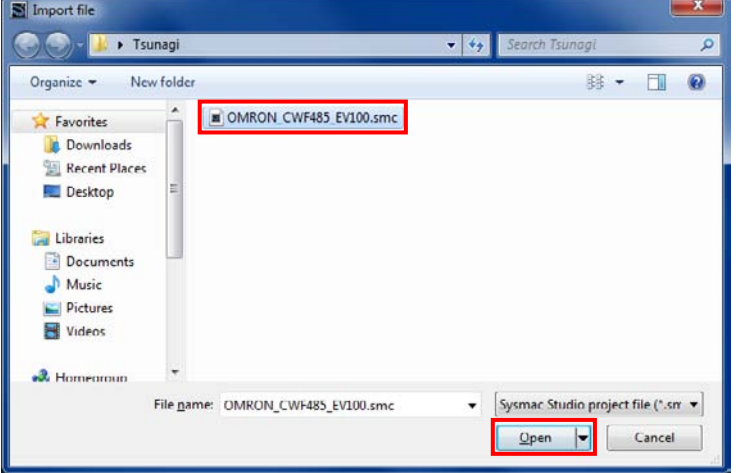
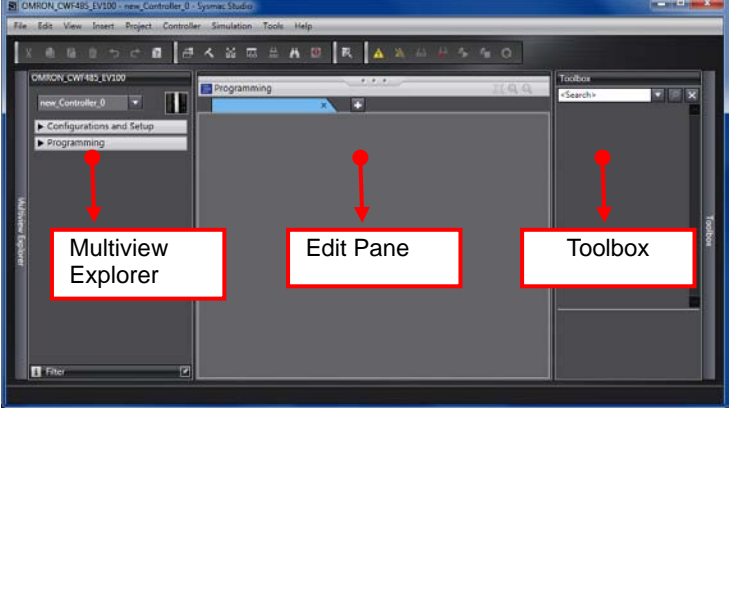
<p>1 Confirm that the personal computer and Controller are connected through the USB cable, and turn ON the power supply to the Controller.</p> <p>Start the Sysmac Studio. Click the Import Button.</p> <p>*If a dialog box is displayed at start confirming the access right, select an option to start.</p>	
<p>2 The Import file Dialog Box is displayed. Select OMRON_CWF485_EV100.smc and click the Open Button.</p> <p>*Obtain the project file from OMRON.</p>	
<p>3 OMRON_CWF485_EV100 project is displayed. The left pane is called Multiview Explorer, the right pane is called Toolbox and the middle pane is called Edit Pane.</p> <p>*If an error message is displayed stating "Failed to Load Descendants", change the version of the Sysmac Studio to any version specified in 5.2. Device Configuration or higher version.</p>	

7.3.3. Parameter Settings and Building

Set the parameters, execute the program check on the project data and build the Controller.

- 1 Double-click **CPU/Expansion Racks** under **Configurations and Setup** in the Multiview Explorer.

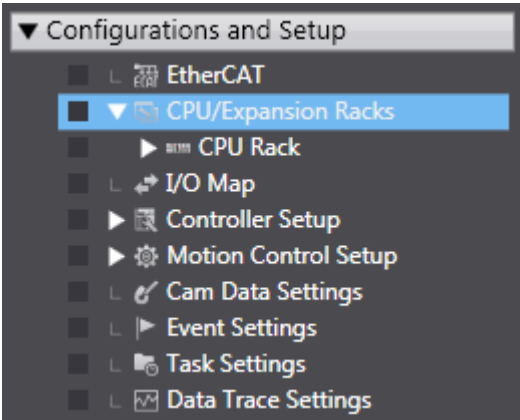

- 2 The CPU/Expansion Racks Tab is displayed on the Edit Pane. Select the Serial Communications Unit icon as shown on the right. Confirm that CJ1W-SCU42 is displayed, the device name is J01, and the unit number is 0.

*If the settings are different from the above, change the value.

Click **Edit Special Unit Settings**.

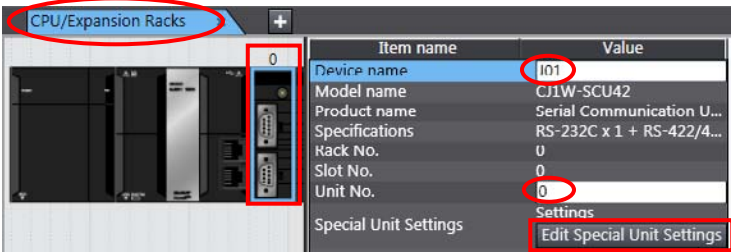

Item name	Value
Device name	J01
Model name	CJ1W-SCU42
Product name	Serial Communication U...
Specifications	RS-232C x 1 + RS-422/4...
Rack No.	U
Slot No.	0
Unit No.	0
Special Unit Settings	Settings
	Edit Special Unit Settings

- 3 The 0 [Unit 0]: Tab is displayed. Select *Port1: Serial Gateway Settings* from the pull-down list of Parameter group to show.

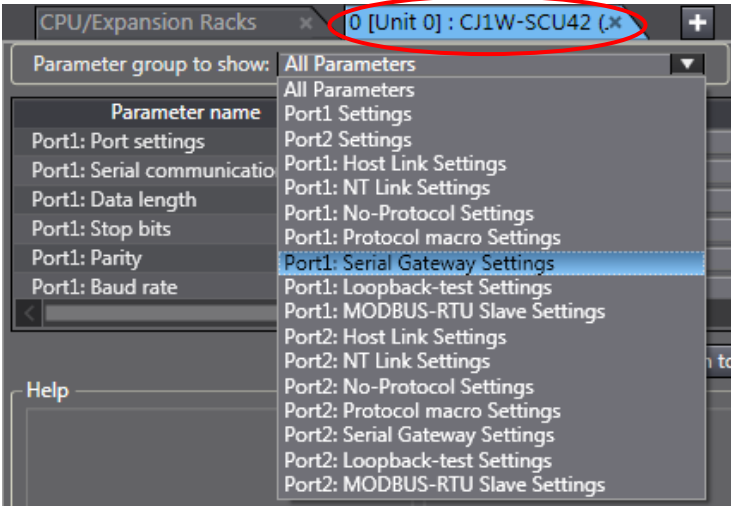

- 4 Parameter group to show is set to *Port1: Serial Gateway Settings*.

The setting items for Port1: Serial Gateway Settings are Displayed.

Confirm that the following settings are made.

- Port settings: User settings
- Serial communications mode: Serial Gateway

*If the settings are different from the above, change a value from each pull-down list. After changing values, click the **Apply** Button.

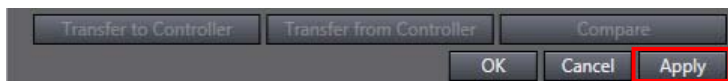
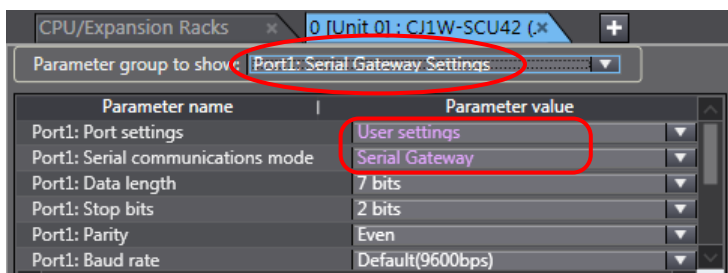

- 5 Change other items as follows:

- Data length: 7 bits
- Stop bits: 7 bits
- Stop bits: 2 bits
- Parity: Even
- Baud rate: 9600bps (Default)

*After changing the settings, click the **Apply** Button in the same way as step 4.

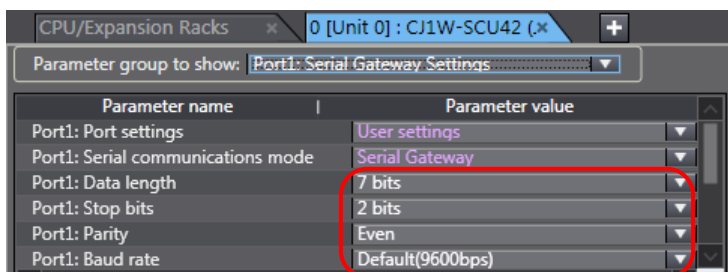

- 6 Double-click **I/O Map** under **Configurations and Setup** in the Multiview Explorer.

The I/O Map Tab is displayed and the parameters of the Unit are displayed.

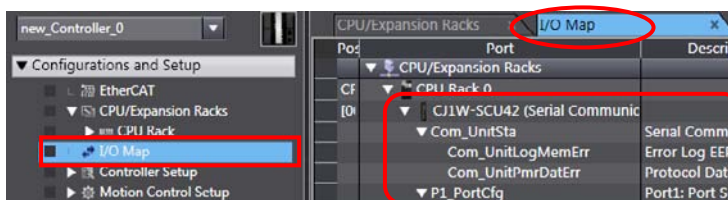

7 Confirm that data in the Variable Columns start with J01 and the Global Variable is set in each Variable Type Column in the I/O Map.

Port	Port	Description	I/W	Data Type	Variable	Variable Comment	Variable Type
CF	↓ CPU/Expansion Racks						
ID	↓ CPU Rack 0						
	↓ CJ1W-SCU42 (Serial Communic						
	↓ Com_UnitSta	Serial Communication U	R	WORD	J01_Com_UnitSta		Global Variables
	Com_UnitLogMemErr	Error Log EEPROM Error	R	BOOL	J01_Com_UnitLogMemErr		Global Variables
	Com_UnitPmrDatErr	Protocol Data Error	R	BOOL	J01_Com_UnitPmrDatErr		Global Variables
	↓ P1_PortCfg	Port1: Port Settings	RW	WORD	J01_P1_PortCfg		Global Variables
	P1_SerSetCfg	Port1: User-specified Set	RW	BOOL	J01_P1_SerSetCfg		Global Variables
	P1_StartBitCfg	Port1: Start Bits	RW	BOOL	J01_P1_StartBitCfg		Global Variables
	P1_DatBitCfg	Port1: Data Length	RW	BOOL	J01_P1_DatBitCfg		Global Variables
	P1_StopBitCfg	Port1: Stop Bits	RW	BOOL	J01_P1_StopBitCfg		Global Variables
	P1_ParityYNCfg	Port1: Parity	RW	BOOL	J01_P1_ParityYNCfg		Global Variables
	P1_ParityBitCfg	Port1: Parity Even/Odd	RW	BOOL	J01_P1_ParityBitCfg		Global Variables
	P1_BaudrateCfg	Port1: Baud Rate	RW	USINT	J01_P1_BaudrateCfg		Global Variables

*If the settings are different from the above, right-click on **CJ1W-SCU42** and select **Create Device Variable**.

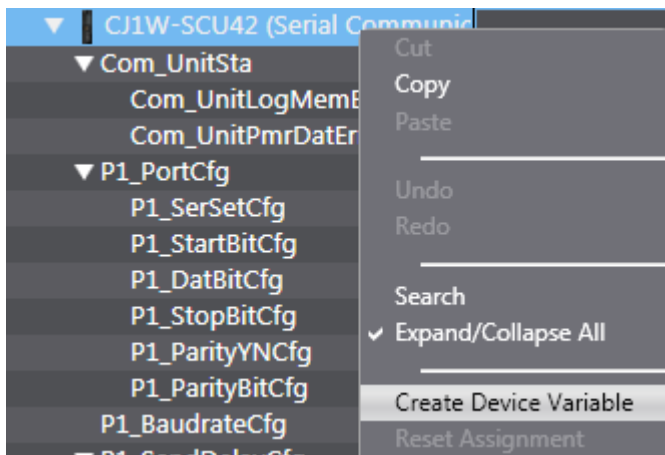

8 Double-click the **Task Settings** under **Configurations and Setup** in the Multiview Explorer.

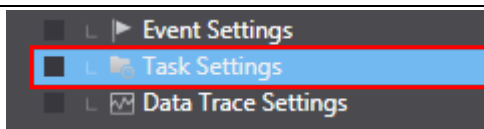

9 The Task Settings Tab Page is displayed in the Edit Pane. Click the **Program Assignment Settings** Button and confirm that Program0 is set under PrimaryTask.

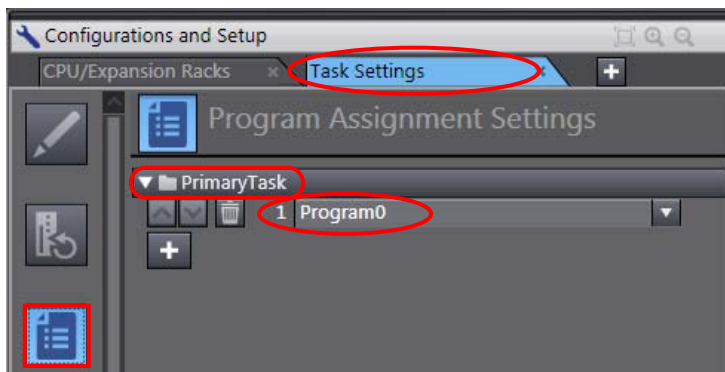

10 Select **Check All Programs** from the Project Menu.

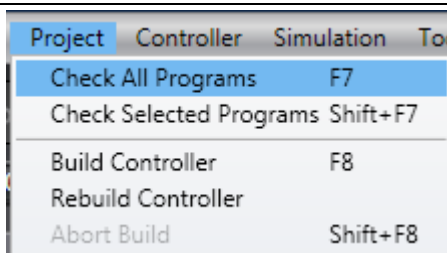

11 The Build Tab Page is displayed in the Edit Pane. Confirm that "0 Errors" and "0 Warnings" are displayed.

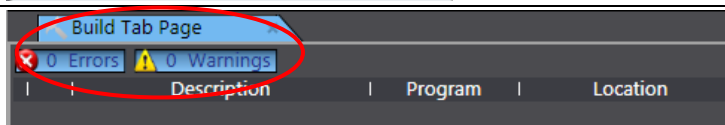

12 Select **Rebuild Controller** from the Project Menu.

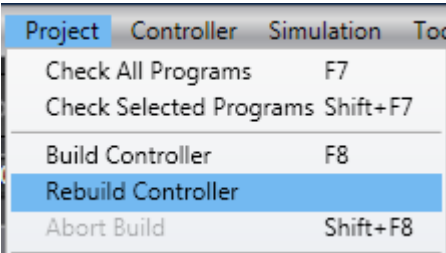

A screen is displayed indicating the conversion is being performed.

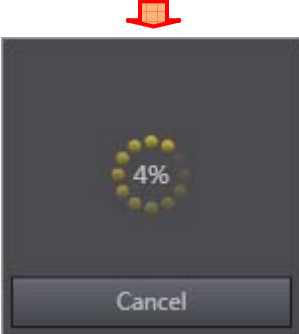

13 Confirm that "0 Errors" and "0 Warnings" are displayed in the Build Tab Page.

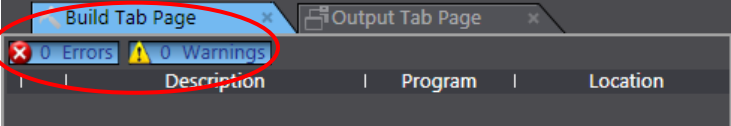

7.3.4. Connecting Online and Transferring the Project Data

Connect online with the Sysmac Studio and transfer the project data to the Controller.

WARNING

Always confirm safety at the destination node before you transfer a user program, configuration data, setup data, device variables, or values in memory used for CJ-series Units from the Sysmac Studio.

The devices or machines may perform unexpected operation regardless of the operating mode of the CPU Unit.



Caution

Always confirm safety before you reset the Controller or any components.

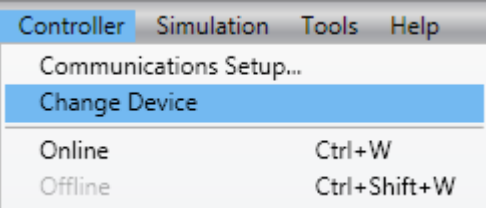
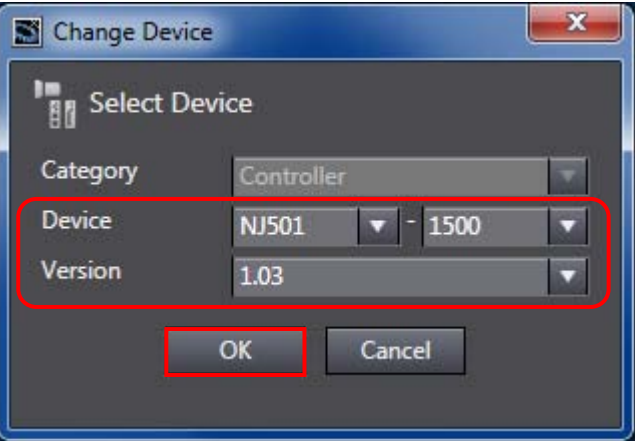
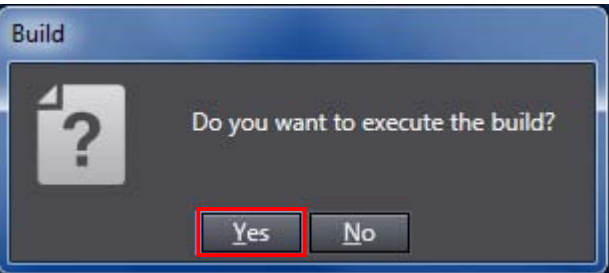

- | | |
|--|--|
| <p>1 Select Change Device from the Controller Menu.</p> |  |
| <p>2 The Change Device Dialog Box is displayed.
Confirm that the Device and Version are set as shown on the right and click the OK Button.</p> <p>*If the settings are different from the above, change a value from each pull-down list.</p> |  |
| <p>3 If the settings were changed in Step 2, the Build Dialog Box is displayed. Click the Yes Button.</p> <p>*This dialog box is not displayed if no change was made.</p> |  |

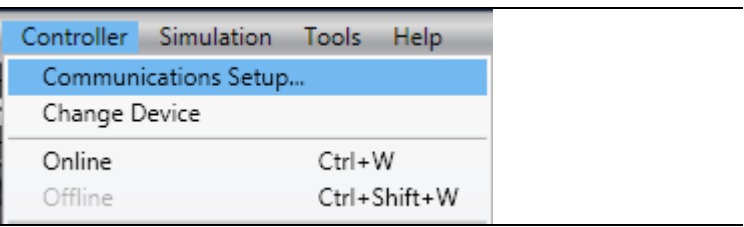
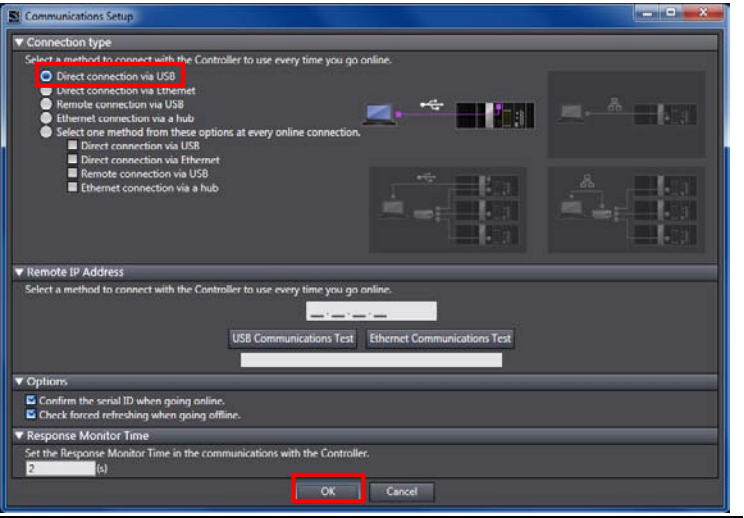
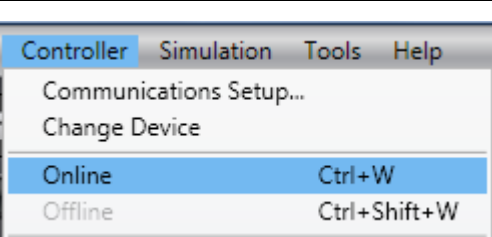
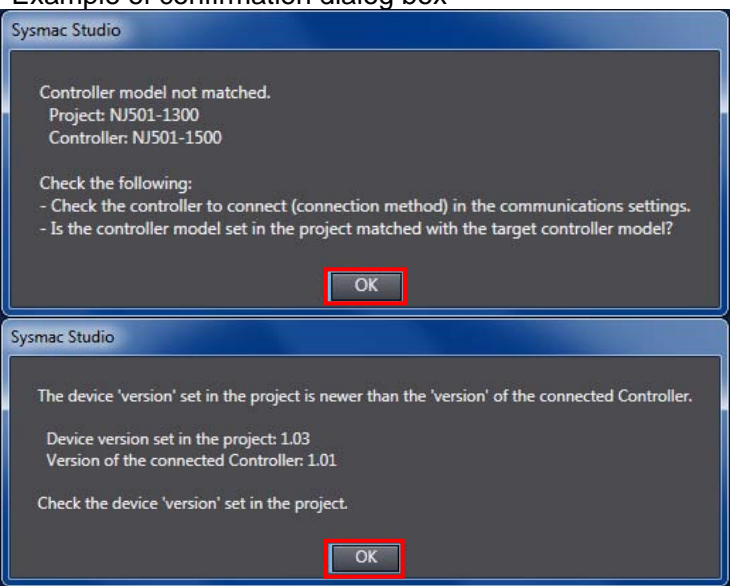
<p>4 Select Communications Setup from the Controller Menu.</p>	
<p>5 The Communications Setup Dialog Box is displayed. Select the <i>Direct connection via USB</i> Option in the Connection Type Field.</p> <p>Click the OK Button.</p>	
<p>6 Select Online from the Controller Menu.</p> <p>*If the dialog on the right is displayed, the model or version of the Controller does not match that of the project file. Check the model and version of the Controller and device settings of the project file. Then, return to step 1 and try again.</p> <p>Click the OK Button to close the dialog box.</p> <p>*The model and version displayed on the confirmation dialog box differ depending on the Controller used and the device settings of the project file.</p>	 <p>*Example of confirmation dialog box</p> 

7 A confirmation dialog is displayed. Click the **Yes** Button.

*The displayed dialog depends on the status of the Controller used. Click the **Yes** Button to proceed with the processing.

*The displayed serial ID differs depending on the device.

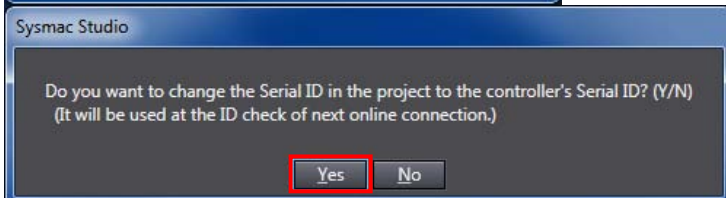
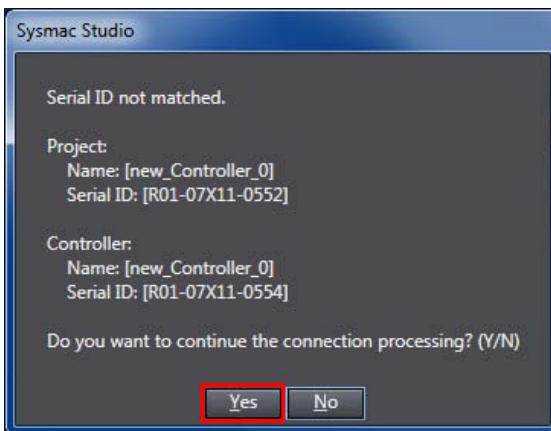
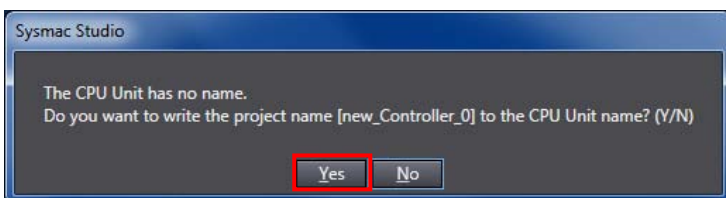

Additional Information

For details on online connections to a Controller, refer to *Section 5 Going Online with a Controller* in the *Sysmac Studio Version 1 Operation Manual (Cat. No. W504)*.

8 When an online connection is established, a yellow bar is displayed on the top of the Edit Pane.



9 Select **Synchronization** from the Controller Menu.

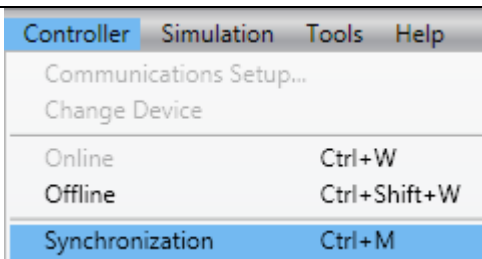

10 The Synchronization Dialog Box is displayed.

Confirm that the data to transfer (NJ501 in the right figure) is selected. Then, click the **Transfer to Controller** Button.

*After executing the **Transfer to Controller**, the Sysmac Studio project data is transferred to the Controller and the data are compared.

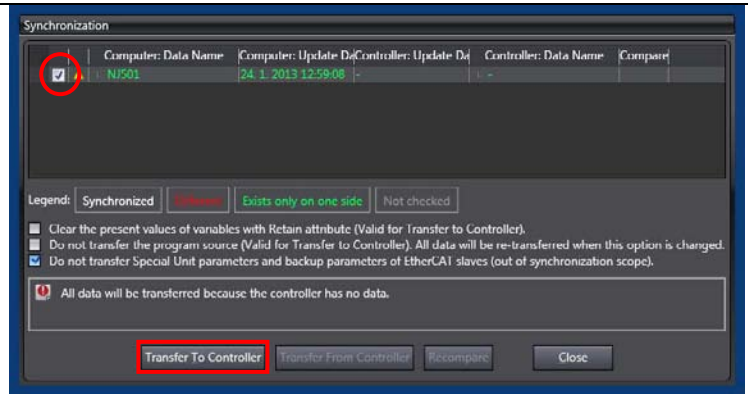

11 A confirmation dialog is displayed. Click the **Yes** Button.

A screen stating "Synchronizing" is displayed.

A confirmation dialog box is displayed. Click the **No** Button.

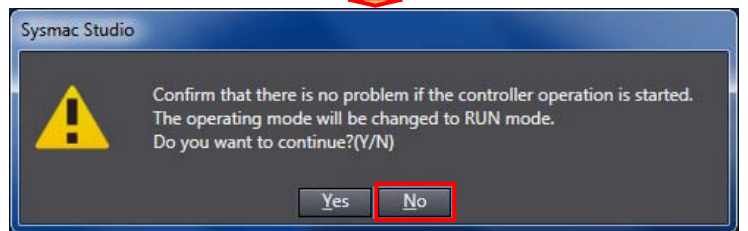
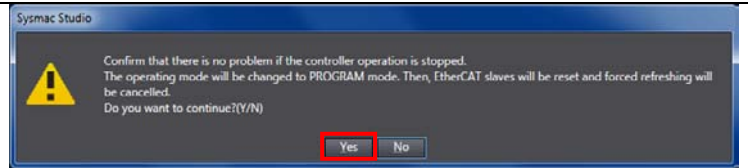

12 Confirm that the synchronized data is displayed with the color specified by "Synchronized" and that a message is displayed stating "The synchronization process successfully finished". If there is no problem, click the **Close** Button.

*A message stating "The synchronization process successfully finished" means that the project data of Sysmac Studio and that of the Controller match.

*If the synchronization fails, check the wiring and repeat the procedure described in this section.

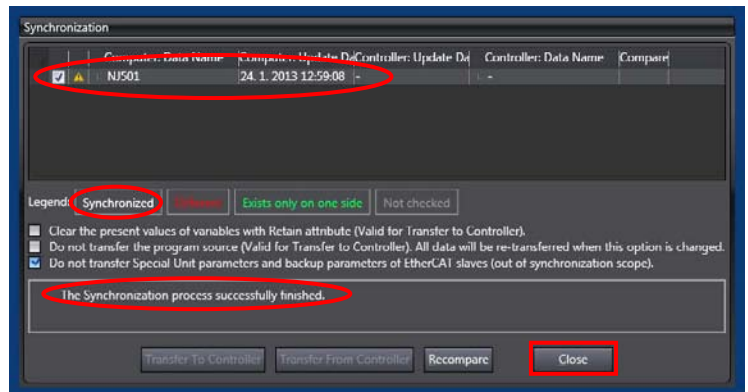

13 Select **Reset Controller** from the Controller Menu.

*When Mode is set to RUN Mode, Reset Controller cannot be selected. In this case, select **Mode - PROGRAM Mode** from the Controller Menu to change to PROGRAM mode and perform this step.



14 A confirmation dialog box is displayed several times. Click the **Yes** Button.

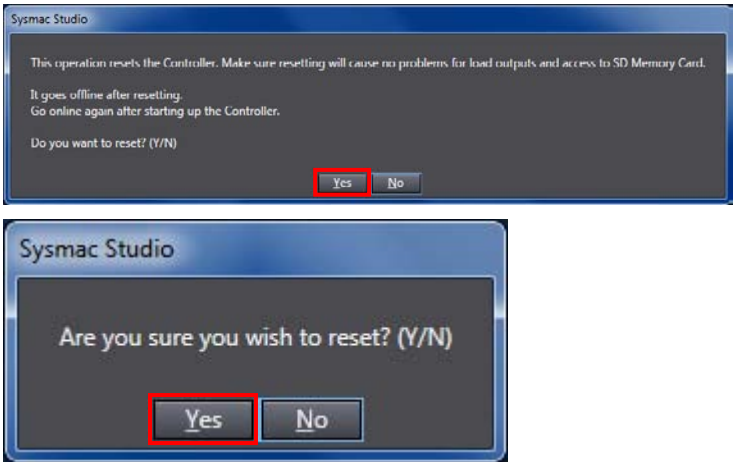

15 The Controller is reset, and Sysmac Studio goes offline. The yellow bar on the top of the Edit Pane disappears. Use steps 6 to 8 to go online again.



7.3.5. Transferring the Unit Settings

Transfer the setting data of the Serial Communication Unit.

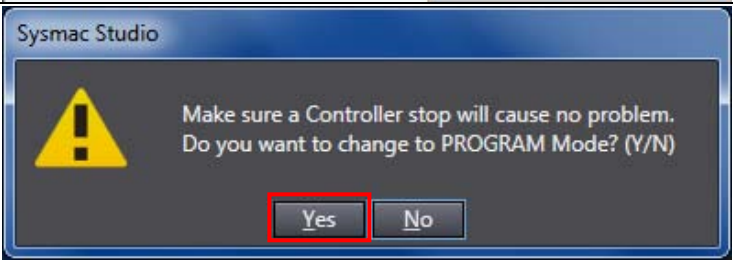
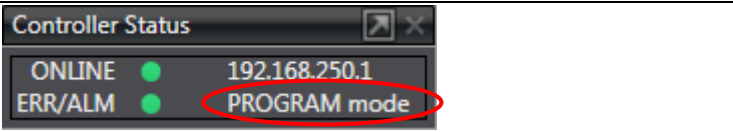
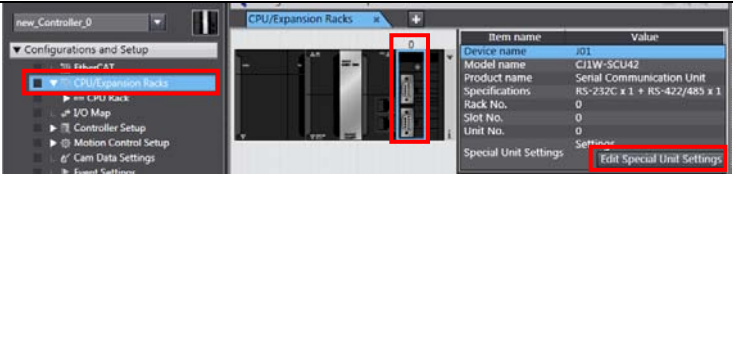
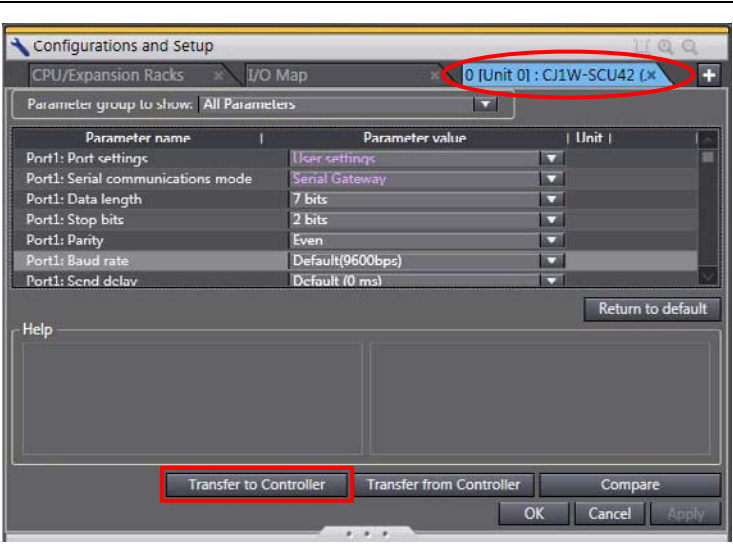
<p>1 Select Mode - PROGRAM Mode from the Controller Menu.</p>	
<p>2 A confirmation dialog box is displayed. Click the Yes Button.</p>	
<p>3 PROGRAM mode is displayed on the Controller Status Pane.</p>	
<p>4 Double-click CPU/Expansion Racks under Configurations and Setup in the Multiview Explorer. Select the Serial Communications Unit icon. Click Edit Special Unit Settings.</p>	
<p>5 The 0 [Unit 0]: Tab is displayed. Click the Transfer to Controller Button.</p>	

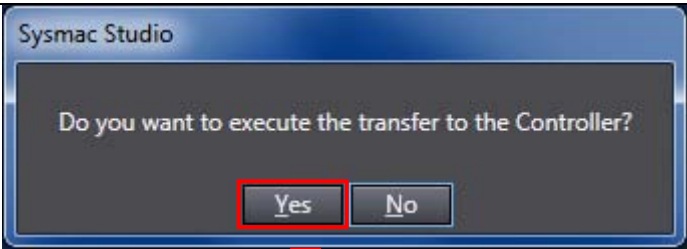
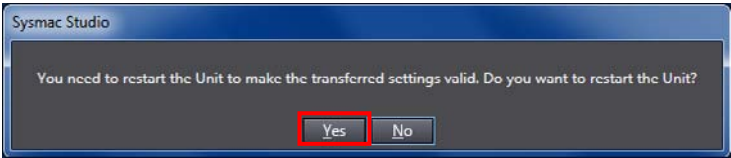
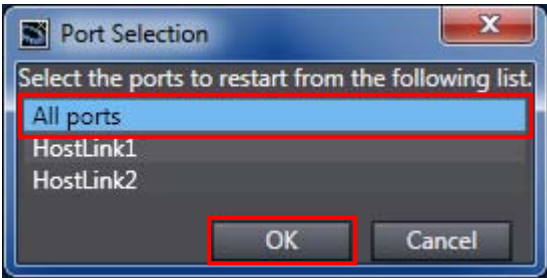
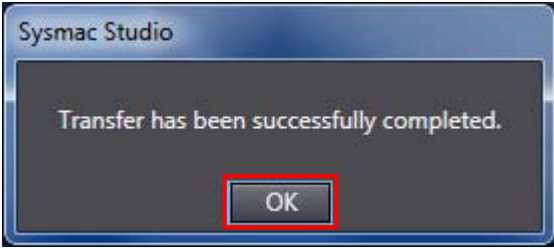
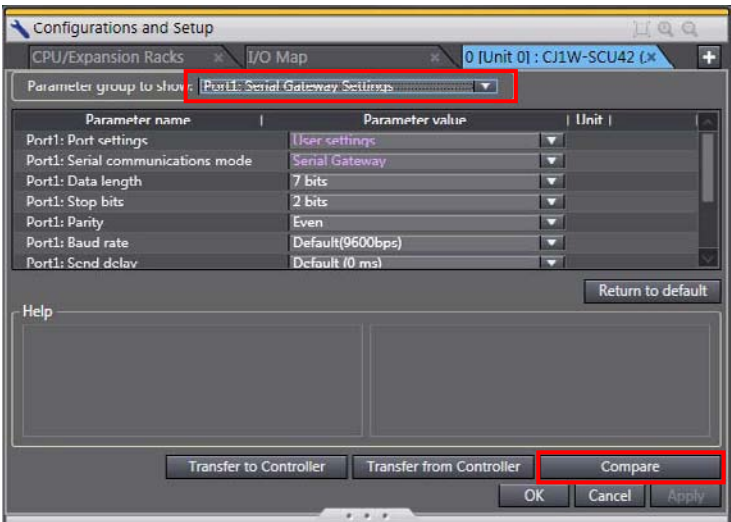
- 6 A confirmation dialog box is displayed.
Click the **Yes** Button.
- 
- A dialog box, which indicates transferring is being performed, is displayed. After that a confirmation dialog box is displayed.
Click the **Yes** Button.
- 
- 7 The Port Selection Dialog Box is displayed.
Select **All ports** and click the **OK** Button.
- 
- 8 A confirmation dialog box is displayed.
Click the **OK** Button.
- 
- 9 Select *Port1: Serial Gateway Settings* from the pull-down list of Parameter group to show.
Click the **Compare** Button.
- 
- 10 Confirm that “≠” (mismatch) is not shown in the red frame on the right.
- | Parameter name | Parameter value | [Compare results] | Unit |
|---------------------------------------|------------------|-------------------|------|
| Port1: Port settings | User settings | User settings | |
| Port1: Serial communications mode | Serial Gateway | Serial Gateway | |
| Port1: Data length | 7 bits | 7 bits | |
| Port1: Stop bits | 2 bits | 2 bits | |
| Port1: Parity | Even | Even | |
| Port1: Baud rate | Default(9600bps) | Default(9600) | |
| Port1: Send delay | Default (0 ms) | Default (0 ms) | |
| Port1: Send delay (user-specified) | 0 | 0 | ms |
| Port1: CTS control | No | No | |
| Port1: Serial Gateway Response time | 0 | 0 | ms |
| Port1: Serial Gateway send start time | 0 | 0 | ms |

7.4. Checking the Serial Communications

Execute the program and confirm that serial communications are performed normally.

Caution

Sufficiently confirm safety before you change the values of variables on a Watch Tab Page when the Sysmac Studio is online with the CPU Unit. Incorrect operation may cause the devices that are connected to Output Units to operate regardless of the operating mode of the Controller.

Precautions for Correct Use

Please confirm that the serial cable is connected before proceeding to the following steps. If it is not connected, turn OFF the power of the devices, and then connect the serial cable.

7.4.1. Executing the Program and Checking the Receive Data

Execute the program and confirm that the correct data are written to the variables of the Controller.

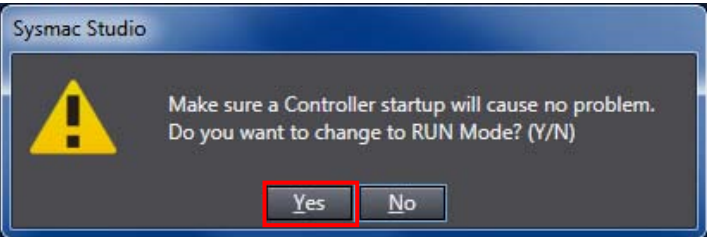
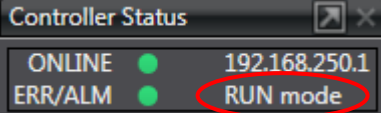
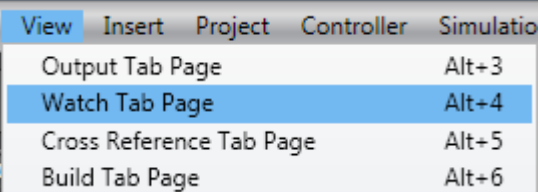
<p>1 Select Mode - RUN Mode from the Controller Menu.</p> <p>A confirmation dialog box is displayed. Click the Yes Button.</p>	 
<p>2 RUN mode is displayed on the Controller Status Pane.</p>	
<p>3 Select Watch Tab Page from the View Menu.</p>	

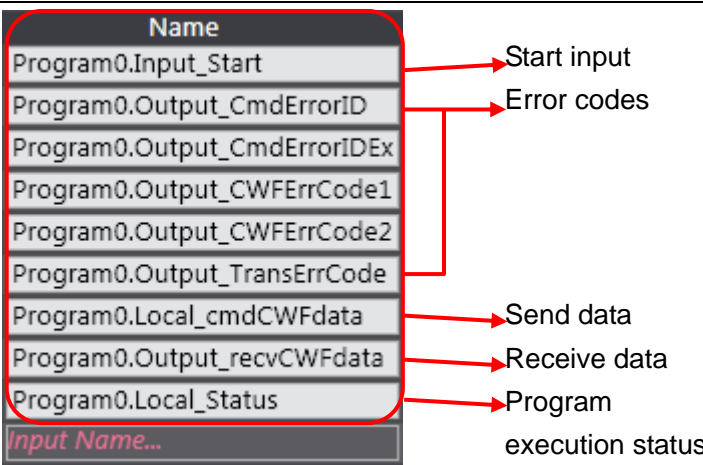
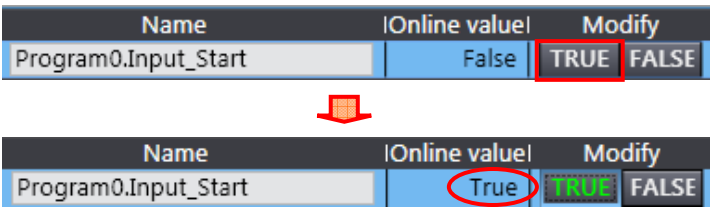
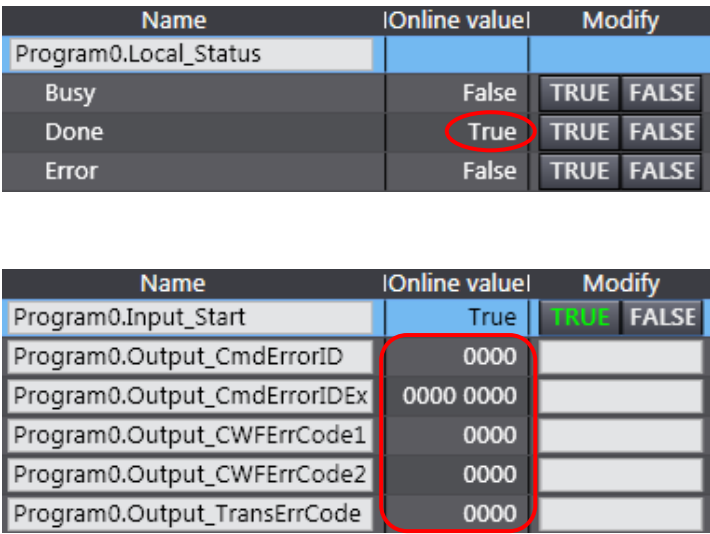
- 4 The Watch Tab Page 1 is displayed in the lower section of the Edit Pane.
- 
- 5 Confirm that the variables shown on the right are displayed in the Name Columns.
- *To add a variable, click *Input Name...*
- *Program0 of the Name is omitted from the following descriptions.
- 
- 6 Click **TRUE** on the Modify Column of *Input_Start*.
- The online value of *Input_Start* changes to TRUE.
- The program is operated and CompoWay/F communications are performed with the destination device.
- 
- 7 When the communications ends normally, the online value of *Local_Status.Done* that indicates the execution status of the program changes to TRUE and each error code changes to 0.
- *In the case of error end, *Local_Status.Error* changes to TRUE and the error code corresponding to the error is stored. For details on error codes, refer to 9.7 Error Process.
- 

8 When the communications ends normally, the response data is stored in *Output_recvCWFdata*. (The send command is stored in *Local_cmdCWFdata*.)

*The text data (Unit attributes) differs depending on the device used

*Refer to 9.2. *Destination Device Command* for details on the command.

Name	Online value
Program0.Local_cmdCWFdata	010000503
Program0.Output_recvCWFdata	01000005030000KM1-PMU2A 00E6

Response data
 01 = Node No.
 00 = Subaddress
 00 = Response code
 0503 = Command (MRC, SRC)
 0000 = Response code (MRES, SRES)
 KM1-PMU2A = Text data (Unit attributes)
 00E6 = Buffer size

8. Initialization Method

This document explains the setting procedure from the factory default setting.

Some settings may not be applicable as described in this document unless you use the devices with the factory default setting.

8.1. Initializing the Controller

To initialize the Controller, it is necessary to initialize the Serial Communications Unit and the CPU Unit. Place in PROGRAM mode before initialization.

8.1.1. Serial Communications Unit

To initialize the settings of the Serial Communications Unit, select **Edit Special Unit Settings** of CJ1W-SCU42 in CPU/Expansion Racks from the Sysmac Studio.

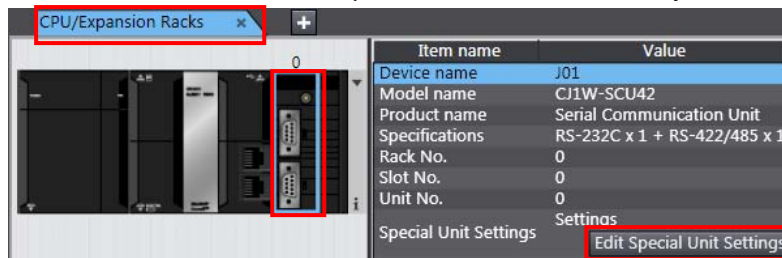

Click the **Return to default** Button and click the **Apply** Button. Then, click the **Transfer to Controller** Button.

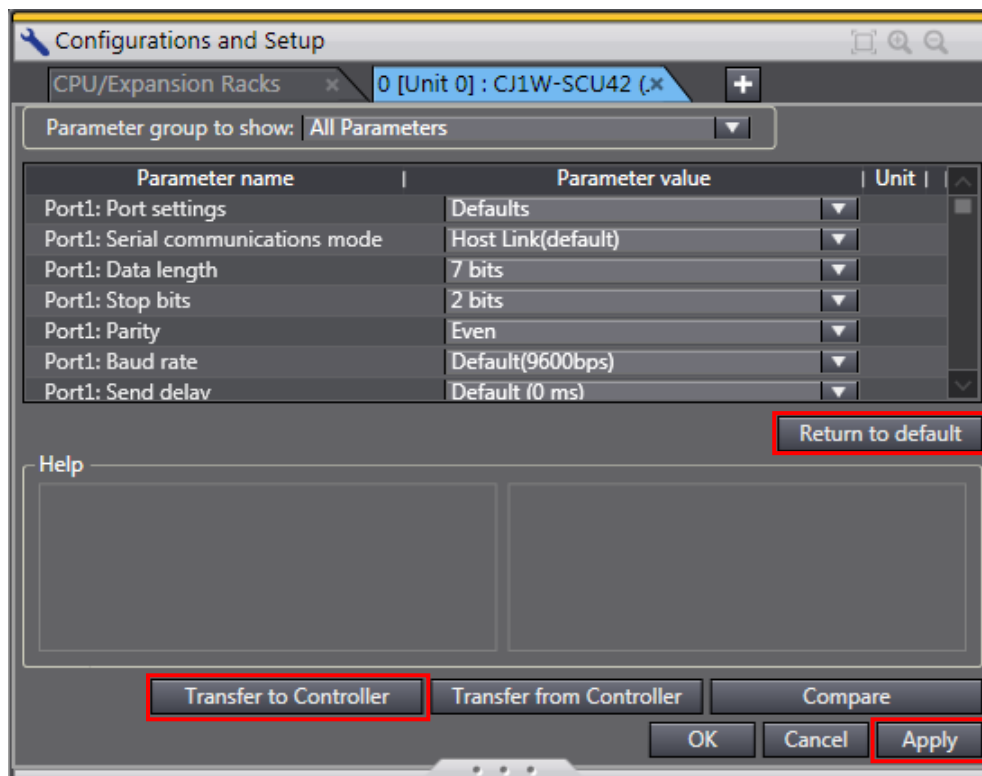

8.1.2. CPU Unit

To initialize the settings of the Controller, select **Clear All Memory** from the Controller Menu of the Sysmac Studio. The Clear All Memory Dialog Box is displayed. Click the **OK** Button.

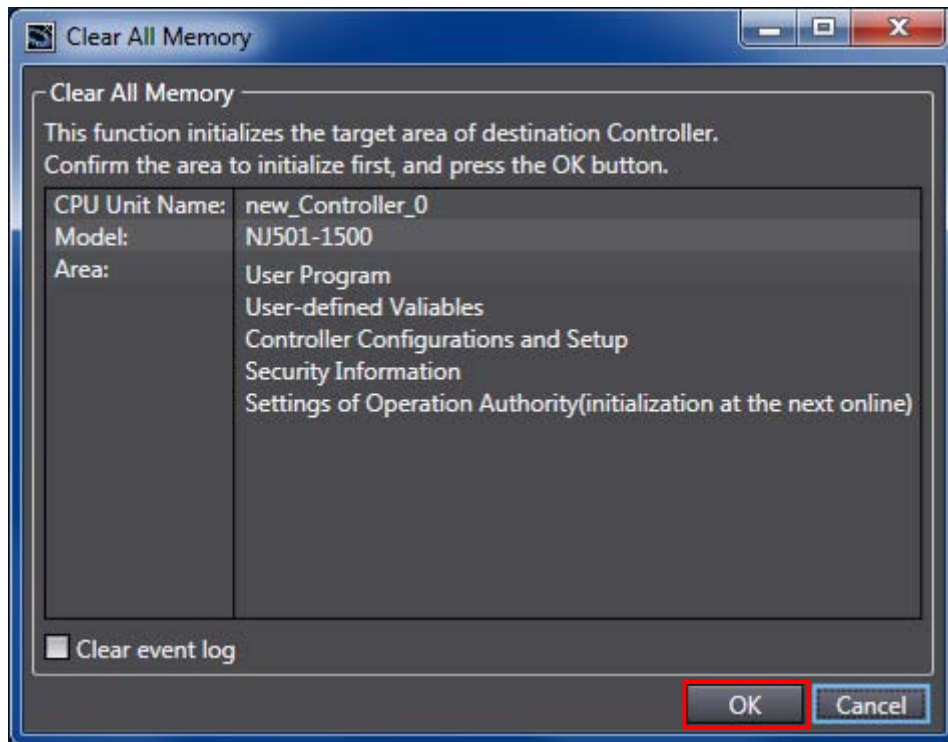

8.2. Initializing the Smart Power Monitor

For information on how to initialize the Smart Power Monitor, refer to 3.6. *Other functions* in the *Smart Power Monitor User's Manual* (Cat. No. N171) or 4.3.6. *Initialization unit* in the *KM1/KE1-Setting User's Manual* (Cat. No. GAMS-010).

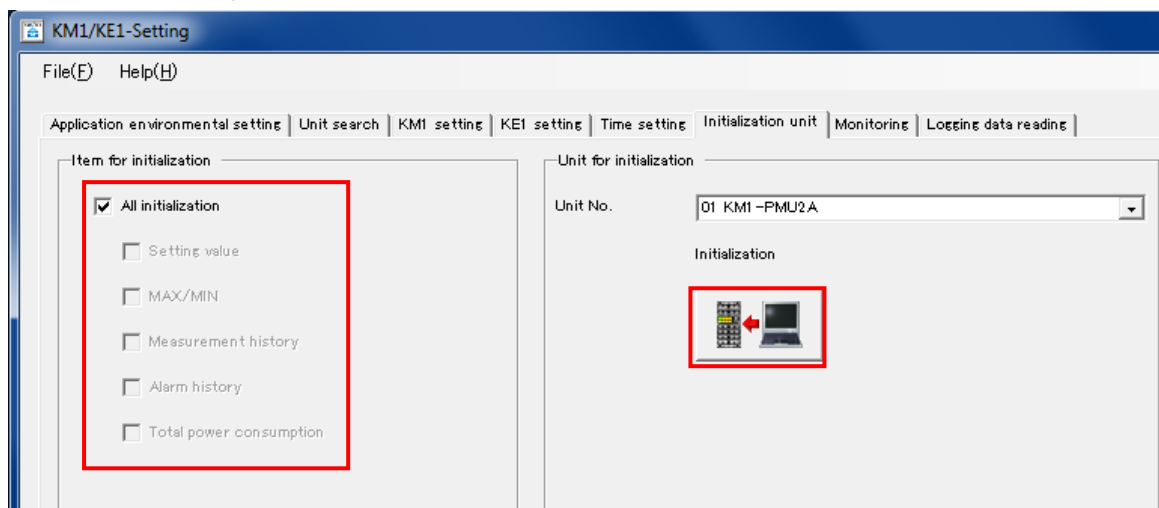

9. Program

This section describes the details on the program in the project file used in this document.

9.1. Overview

This section explains the specifications and functions of the program used to check the connection between the Smart Power Monitor (hereinafter referred to as the destination device) and the Controller (Serial Communications Unit) (hereinafter referred to as an SCU).

This program performs the CompoWay/F communications by using the Serial Gateway function of the SCU to send/receive the "Read Unit Attributes" command to/from the destination device and to detect a normal end or an error end.

A normal end of this program means a normal end of the CompoWay/F communications.

An error end means an error end of the CompoWay/F communications and an error end of the destination device (detected with the response data from the destination device).

In this section, the prefix "10#" (possible to omit) is added to decimal data and the prefix "16#" to hexadecimal data when it is necessary to distinguish between decimal and hexadecimal data. (e.g., "1000" or "10#1000" for decimal data and "16#03E8" for hexadecimal data, etc.) Also, to specify a specific data type, the prefix "<data type>#" is added. (e.g., "WORD#16#03E8")



Additional Information

OMRON has confirmed that normal communications can be performed using this program under the OMRON evaluation conditions including the test system configuration, version of each product, and product Lot, No. of each device which was used for evaluation.

OMRON does not guarantee the normal operation under the disturbance such as electrical noise and the performance variation of the device.

9.1.1. Communications Data Flow

The following figure shows the data flow from when the Controller (SCU) issues the command data to the destination device until when the Controller receives the response data from the destination device.

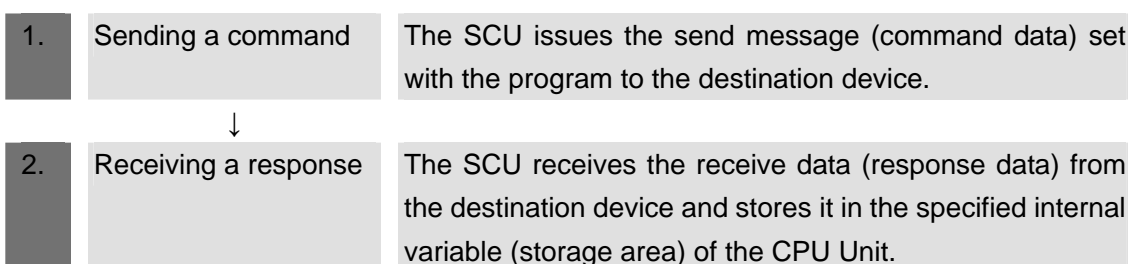

9.1.2. Command Send Instruction and Send/Receive Message

This section outlines the command send function block (hereinafter referred to as command send instruction) and the general operation of the send/receive messages.



Additional Information

For details, refer to *Communications Instructions in 2 Instruction Descriptions* of the *NJ-series Instructions Reference Manual* (Cat. No. W502).

•Command send instruction

This program uses the following standard instruction to perform serial communications.

Name	Function block	Description
Send command	SendCmd	Sends the command to the Serial Communications Unit by using the Serial Gateway function.

•SendCmd instruction argument data

Instruction	Name	FB/FUN	Graphic expression	ST expression
SendCmd	Send Command	FB	<pre> graph TD subgraph SendCmd_instance [SendCmd_instance] subgraph SendCmd [SendCmd] Execute --- Done DstNetAdr --- Busy CommPort --- Error CmdDat --- ErrorID CmdSize --- ErrorIDEx RespDat Option end end </pre>	SendCmd_instance(Execute, DstNetAdr, CommPort, CmdDat, CmdSize, RespDat, Option, Done, Busy, Error, ErrorID, ErrorIDEx);

Variables

Name	Meaning	I/O	Description	Valid range	Unit	Default
DstNetAdr	Destination network address	Input	Destination network address	---	---	---
CommPort	Destination serial port		Destination serial port	Only _NONE		_NONE
CmdDat[] (array)	Command array		Command to send	Depends on data type.		*
CmdSize	Command data size		Command data size	2 to maximum data length (depends on network type)	Bytes	2
Option	Response		Response monitoring and retry specifications	---	---	---
RespDat[] (array)	Response storage array	In-out	Array to store response	Depends on data type.	---	---

* If you omit an input parameter, the default value is not applied. A building error will occur.

[DstNetAdr: Destination network address]

The following table lists the variables used to store the destination network address.

Variable	Setting item	Data type	Description
DstNetAdr	Destination network address	_sDNET_ADR	Destination network address
NetNo	Network address	USINT	USINT#16#00 (Fixed): Local network
NodeNo	Node address	USINT	USINT#16#00 (Fixed): Communications in local Controller
UnitNo	Unit address	BYTE	Make the following setting. Unit address of serial port For Serial Communications Unit Port 1: 16#80+16#04 × [Unit number (Hex)] Port 2: 16#81+16#04 × [Unit number (Hex)] *For example, when the Unit number (No.10) port 2 is used, the Unit address of the serial port is as follows: = 16#81 + 16#04 × 16#0A=16#81+16#28 = 16#A9

[CommPort: Destination serial port]

The following table shows the variable that stores a destination serial port number.

Variable	Setting item	Data type	Description
CommPort	Destination serial port	_ePORT	_NONE: The destination is not a serial port in Host Link Mode *To specify the serial port unit address as the Destination unit address, set <i>_NONE</i> .

[CmdSize: Command data size]

The following table shows the variable that stores the number of bytes of the command (send data).

Variable	Setting item	Data type	Description
CmdSize	Command data size	UINT	Sets the number of bytes of command data. (UINT#2 to maximum data length)

[Option: Response]

The following table shows the variables that store settings to receive a response.

Variable	Setting item	Data type	Description
Option	Response	_sRESPONSE	Response monitoring and retry specifications
isNonResp	No response	BOOL	TRUE: Response is not required. FALSE: Response is required.
TimeOut	Timeout time	UINT	Sets UINT#1 to 65535 (indicate 0.1 to 6553.5 sec). (UINT#0: 2 sec (Default))
Retry	Retry count	USINT	Sets USINT#0 to 15 (0 to 15 times).

[CmdDat[] array: Command array (send data)]

With this program, after the command (send data) is set with the STRING variable (Local_cmdCWFdata), it is converted to BYTE array data and stored in the BYTE array variable (Local_cmddata). Then, the data is transferred to the command array (CmdDat[]).

Command array

[0]	[1]	[2]	[3]	[4]	[5]	[6]	[7]	[8]	[9]	[10]	[11]		
28	03	AA	BB	CC	DD	EE	FF	GG	HH	II	**	**	**	
CompoWay/F comm.. command		Node No.		Subaddress		SID	Command			Text				
							MRC			SRC				

*CompoWay/F communications command (16#2803) is a command that can be executed to use CompoWay/F with the Serial Gateway function of the SCU.

*The command data in the shaded areas from AA onwards are expressed in ASCII codes.

[RespDat[] array: Response storage array (receive data)]

With this program, after the response (receive data) is received in the response storage array (RespDat[]), it is stored in the BYTE array variable (Local_recvdata), converted to STRING data, and then stored in the STRING data variable (Output_recvCWFdata).

Response storage array

[0]	[1]	[2]	[3]	[4]	[5]	[6]	[7]	[8]	[9]	[10]	[11]	[12]	[13]	[14]	[15]	[16]	[17]	..
28	03	aa	bb	AA	BB	CC	DD	cc	dd	FF	GG	HH	II	ee	ff	gg	hh	**
CompoWay/F comm.. command		Comma nd end code	Node No.	Sub address		End code	Command			Response				Text				
							MRC			SRC		MRES		SRES				

*The response data in the shaded areas from AA onwards are expressed in ASCII codes.

*The response data not in thick frames such as AA will be the same values as those of the command code.

*The response data in thick frames (cc, dd, ee to hh) will be stored in the variables below as the destination device error code when a destination device error occurs.

For details on error codes, refer to 9.7.2 Destination Device Errors.

Output_CWFErrCode1: End code

Output_CWFErrCode2: Response (MRES,SRES)

*"aa" and "bb" command end codes are not used in this document or this program.

•Send/Receive messages

[Overview of send/receive messages]

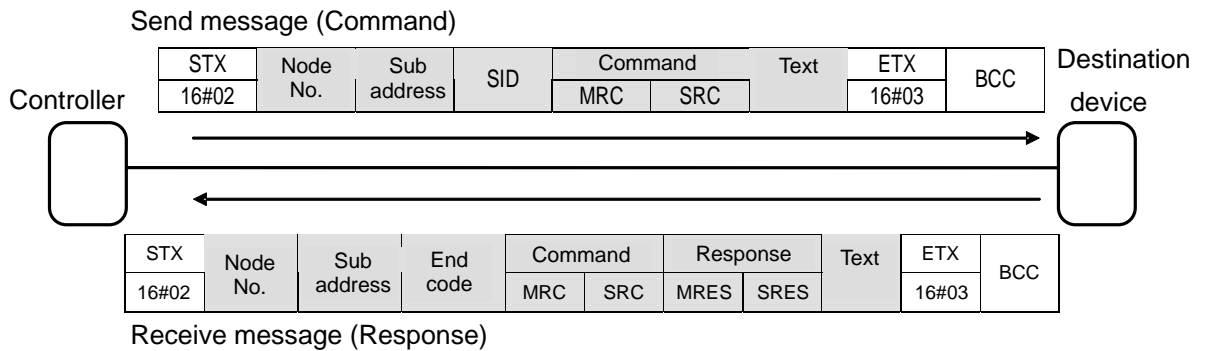

[Relationship between send command (SendCmd instruction operand) and send message]

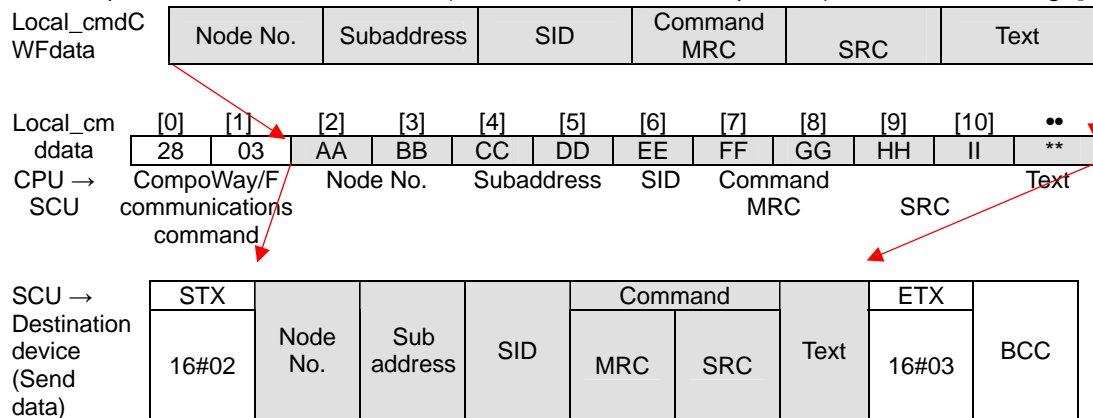

[Relationship between receive response (SendCmd instruction operand) and receive message]

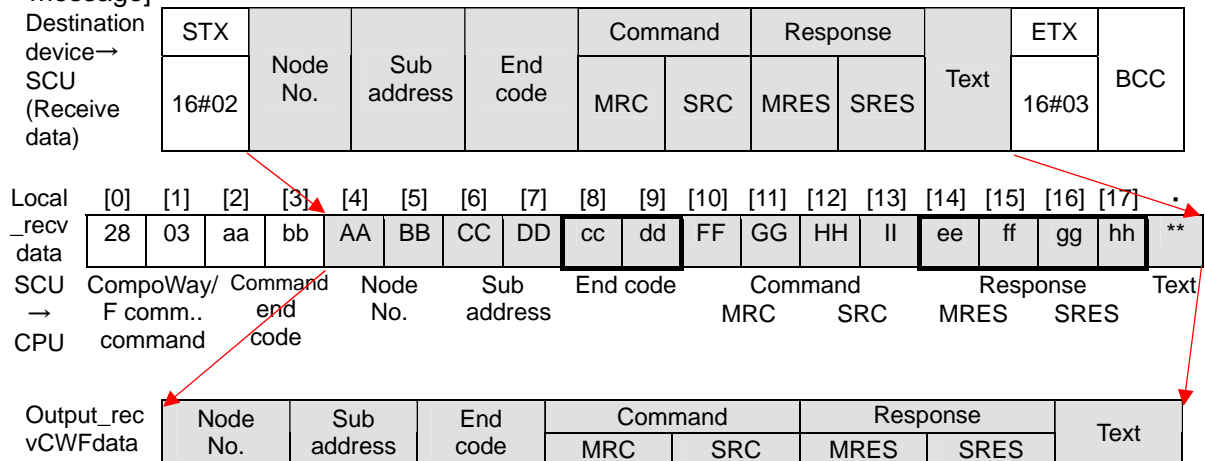

9.2. Destination Device Command

This section explains the destination device command used in this program.

9.2.1. Overview of the Command

This program uses the Read Unit Attributes command to read the information from the destination device.

Command name	Description
Read Controller Attributes	Reads the attributes of the destination device.

9.2.2. Detailed Description of the Function

This section explains the “Read Controller Attributes” command.

•SendCmd instruction send data

[DstNetAdr: Destination network address]

Variable	Setting item	Data type	Setting value	
DstNetAdr	Destination network address	_sDNET_ADR	-	
NetNo	Network address	USINT	16#00	Fixed: Local network
NodeNo	Node address	USINT	16#00	Fixed: Within local controller
UnitNo	Unit address	BYTE	16#80	Unit number 0 + Port number 1

[CommPort: Destination serial port]

Variable	Setting item	Data type	Setting value	
DstNetAdr	Destination serial port	_ePORT	_NONE	Fixed

[CmdSize: Command data size]

Variable	Setting item	Data type	Setting value	
DstNetAdr	Command data size	UINT	11	11 bytes

[Option: Response]

Variable	Setting item	Data type	Setting value	
Option	Response	_sRESPONSE	-	
isNonResp	No response	BOOL	FALSE	Response is required
TimeOut	Timeout time	UINT	0	Default: 2 sec
Retry	Retry count	USINT	3	3 times

[CmdDat []: Command array]

Variable	Setting item	Data type	Setting value		
CmdDat	Command array	ARRAY[0..255] OF BYTE	-		
Element number					
0	CompoWay/F communications command	BYTE	16#28	Fixed	
1		BYTE	16#03		
2	Node No.	BYTE	16#30	"01": Unit No. of destination device	
3		BYTE	16#31		
4	Subaddress	BYTE	16#30	"00": Fixed (Not used)	
5		BYTE	16#30		
6	SID	BYTE	16#30	"0" : Fixed (Not used)	
7	Command	MRC	BYTE	"0503": "Read Controller Attributes" command	
8		BYTE	16#35		
9		SRC	BYTE		16#30
10			BYTE		16#33
:	Text	BYTE***	16#00	"": The setting is not required for this command.	

*After the data in the red frame above is set in the following string variable in the CWFCmdsSet function block, it is transferred to the command array (CmsDat[]).

Variable	Data type	Data
Local_cmdCWFdata	STRING[256]	CONCAT(NodeNo, SubAddress, SID, MRC SRC, SendText);

●SendCmd instruction receive data

[RespDat []: Response storage array]

Variable	Item stored	Data type	Storage value		
RespDat	Response storage array	ARRAY[0..255] OF BYTE	-		
Element number					
0	CompoWay/F communications command	BYTE	16#28	Fixed: Same as CmdDat[0]	
1		BYTE	16#03	Fixed: Same as CmdDat[1]	
2	Command end code	BYTE	16#**	End code of CompoWay/F communications command	
3		BYTE	16#**		
4	Node No.	BYTE	16#30	"01": Unit No. of destination device	
5		BYTE	16#31		
6	Subaddress	BYTE	16#30	"00": Fixed (Not used)	
7		BYTE	16#30		
8	End code	BYTE	16#**	"xx": End code ("00": Normal end)	
9		BYTE	16#**		
10	Command	MRC	BYTE	"0503": "Read Controller Attributes" command	
11		BYTE	16#35		
12		SRC	BYTE		16#30
13			BYTE		16#33
14	Response	MRES	BYTE	"xxxx" ("0000": Normal end)	
15		BYTE	16#**		
16		SRES	BYTE		16#**
17	BYTE		16#**		
:	Text	BYTE***	16#***	"xxxx***"	

•Send message

This is the command format of the message that is sent by the Controller to the destination device according to the setting of the “Read Controller Attributes” command.

- Except for STX, ETX and BCC, ASCII codes are sent.
- STX, ETX and BCC are automatically added to the send message by the SCU.
- Data not used are moved forward.

02	30	31	30	30	30	30	35	30	33					03	xx
STX	Node No.		Subaddress		SID	Command MRC		Command SRC		Text (Not used)				ETX	BCC

•Receive message (at normal operation)

This is the response format of the normal message received by the Controller from the destination device according to the settings of the “Read Controller Attributes” command.

- Except for STX, ETX and BCC, ASCII codes are received.
- STX, ETX and BCC are automatically removed from the receive message by the SCU.
- Data not used are moved forward.

02	30	31	30	30	30	30	30	35	30	33	30	30	30	30	
STX	Node No.		Subaddress		End code		Command MRC		Command SRC		Response MRES		Response SRES		
Continued															
**		**		**		**		**		**		**		**	
Product type										Buffer size					
Continued															
													03	**	
													ETX	BCC	

•Receive message (at error operation)

This is the response format for the error message received by the Controller from the destination device.

- Except for STX, ETX and BCC, ASCII codes are received.
- STX, ETX and BCC are automatically removed from the receive message by the SCU.

02	30	31	30	30	**	**	30	35	30	33	**	**	**	**
STX	Node No.		Subaddress		End code		Command MRC		Command SRC		Response MRES		Response SRES	
Continued														
													03	**
													ETX	BCC

*For details on the end codes and response codes, refer to 9.7.2 Destination Device Error.



Additional Information

For details on the destination device command and message format, refer to *Chapter 2 CompoWay/F Communication Procedure* in the *Smart Power Monitor Communication Manual for Smart Measurement and Monitoring Instrument* (Cat. No. N172).

9.3. Error Detection Processing

This section explains the error detection processing of this project file.

9.3.1. Error Detection in the Project File

This program detects and handles the errors (1) and (2). For information on error codes, refer to 9.7 *Error Process*.

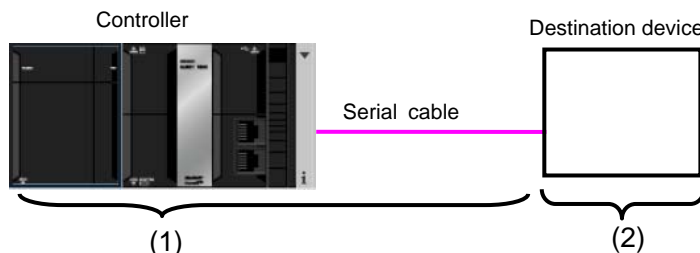

(1) Errors at execution of SendCmd instruction (SendCmd instruction errors)

Errors in the Unit, command format, or parameters at the execution of the SendCmd instruction are detected as "SendCmd instruction errors". An error is detected according to the error codes *ErrorID* and *ErrorIDEx* of the SendCmd instruction.

If a communications error is caused by a transmission error due to, for example, a character corruption or unmatched baud rate setting, the transmission error status (J01_P1_TransErrSta) allocated variable area of the SCU is stored in the output variable to show the communication error status.

(2) Errors in the destination device (Destination device errors)

The destination device errors include a command error, a parameter error, and an execution failure in the destination device. An error is detected according to the response data which is sent from the destination device. When an error occurred in the destination device, the error codes are set in the end code and response of the receive data.

Local _recv data	[0]	[1]	[2]	[3]	[4]	[5]	[6]	[7]	[8]	[9]	[10]	[11]	[12]	[13]	[14]	[15]	[16]	[17]	.
	28	03	aa	bb	AA	BB	CC	DD	cc	dd	FF	GG	HH	II	ee	ff	gg	hh	**
	CompoWay/Command F comm. command		end code		Node No.		Sub address		End code		Command			Response				Text	

9.4. Variables

The following lists the variables used in this program.

9.4.1. List of Variables

The data types, external variables (user-defined global variables/system-defined variables), and internal variables used in this program are listed below.

- Data type (Structure)

[Communications processing status flags]

Name	Data type	Description
sStatus	STRUCT	Structure of communications processing status flags
Busy	BOOL	Communications processing in progress flag TRUE: Processing is in progress. FALSE: Processing is not in progress.
Done	BOOL	Communications processing normal end flag TRUE: Normal end / FALSE: Other than normal end
Error	BOOL	Communications processing error end flag TRUE: Error end / FALSE: Other than error end

- External variables

[User-defined global variables]

Variable name	Data type	Description
Input_Start	BOOL	Communication start switch The program is started when this switch changes from FALSE to TRUE.
Output_recvCWFdata	STRING[256]	An area that stores the receive data (STRING type: 256 characters)
Output_CmdErrorID	WORD	An area that stores an error code of SendCmd instruction Normal end: 16#0000
Output_CmdErrorIDEx	DWORD	An area that stores an expansion error code of SendCmd instruction Normal end: 16#00000000
Output_TransErrCode	WORD	Transmission error status for a communication error An area that stores J01_P1_TransErrSta Normal end: 16#0000
Output_CWFErrCode1	WORD	An area that stores the destination device end code for a destination device error Normal end: 16#0000
Output_CWFErrCode2	WORD	An area that stores the destination device response code for a destination device error Normal end: 16#0000

[Device variables for CJ-series Unit CJ] (Serial Communications Unit)

Variable name	Data type	Description
J01_P1_TransErr	BOOL	Transmission error
J01_P1_TransErrSta	BOOL	Transmission error status



Additional Information

For the variables of the Serial Communications Unit, refer to *2-3 Device Variable for CJ-series Unit* in the *CJ-series Serial Communications Units Operation Manual for NJ-series CPU Unit* (Cat.No. W494).

[System-defined variable]

Variable name	Data type	Description
_Port_isAvailable	BOOL	Network Communications Instruction Enabled Flag TRUE: A port is available. FALSE: A port is not available.



Additional Information

For the system-defined variables for the SendCmd instruction, refer to *2 Instruction Descriptions - Communications Instruction* in the *NJ-series Instructions Reference Manual* (Cat. No. W502).

• Internal variables (instance variables)

The internal variables used to execute the function blocks in the program are listed below. An internal variable is called an "instance". The name of each function block to use is specified as the data type of the variable.

[Instance for user-defined function block]

Variable name	Data type	Description
CWFCmdsSet_instance	CWFCmdsSet	Sets the byte sizes of send/receive data and sets the send message.

*For the user-defined function block, refer to *9.5.3. Detailed Description of the Function Block*.

[Instance for SendCmd instruction]

Variable name	Data type	Description
SendCmd_instance	SendCmd	This function block sends the command to the Serial Communications Unit by using the Serial Gateway function.



Additional Information

For the SendCmd instruction, refer to *Communications Instructions* in *Section 2 Instruction Descriptions* of the *NJ-series Instructions Reference Manual* (Cat. No. W502).

• Internal variables

Variable name	Data type	Description
Local_Status	sStatus	Communications processing status flags This variable is defined as sStatus structure.
Local_State	DINT	Processing number
Local_ExecFlgs	BOOL	Communications instruction execution flag
Local_InitialSettingOK	BOOL	Initialization processing normal setting flag
Local_DstNetAdr	_sDNET_ADR	Destination address for SendCmd instruction setting
Local_CommPort	_ePORT	Destination serial port for SendCmd instruction setting
Local_sendSize	UINT	Send command data size for SendCmd instruction setting
Local_Option	_sRESPONSE	Response setting for SendCmd instruction setting
Local_cmddata	ARRAY[0..255] OF BYTE	Command array for SendCmd instruction setting (256 bytes)
Local_recvdata	ARRAY[0..255] OF BYTE	Response storage array for SendCmd instruction setting (256 bytes)
Local_cmdCWFdata	STRING[256]	An area that stores the send data (STRING type: 256 characters)

9.5. ST Program

9.5.1. Functional Components of the Program

This program is written in the ST language. The functional components are as follows:

Major classification	Minor classification	Description
1. Communications processing	1.1. Starting the communications processing 1.2. Clearing the communications processing status flags 1.3. Communications processing in progress status	The communications processing is started.
2. Initialization processing	2.1. Initializing the communications instruction 2.2. Initializing the communications execution instruction flag 2.3. Initializing the error code storage areas 2.4. Setting the SendCmd instruction control data 2.5. Setting the send variables 2.6. Initialization setting end processing	The receive data storage areas and the error code storage areas are initialized. The parameters and send data are set for the SendCmd instruction (CompoWay/F communications).
3. CompoWay/F communications processing	3.1. Determining the communications processing status and setting the execution flag 3.2. Executing the communications instruction	SendCmd instruction (CompoWay/F communications) are executed. Whether the execution ends normally or ends in an error is detected.
4. Processing number error process	4.1. Processing number error process	The error processing is performed when a non-existent number is detected.

9.5.2. Program List

The program is shown below.

The communications setting and send data (command data) setting which need to be changed depending on the destination device are set in the function block (CWFCmdsSet). For information on how to change these values, refer to 9.5.3 *Detailed Description of the Function Block*.

- Program: Program0 (General-purpose serial communications connection check program)

1. Communications processing

```
(*=====
Name: NJ-series CompoWay/F (RS-485) communications
      connection check program
Serial Communications Unit: CJ1W-SCU42 (CompoWay/F, Unit number: 0, Serial port number :1)
Version: V1.00 New release 17 December 2012
(C)Copyright OMRON Corporation 2012 All Rights Reserved.
===== *)
```

```
(* 1. Communications processing
   Communications start switch: Input_Start
   Communications processing status flags: Local_Status<STRUCT>
   .Busy: Communications in progress
   .Done: Communications normal end
   .Error: Communications error end
   State processing number: Local_State
   10:Initialization processing
   11:CompoWay/F communications processing *)
```

```
(* 1.1. Starting the communications processing
   Start communications processing when the communications start switch changes to ON
   when communications processing status flags have been cleared. *)
```

```
IF Input_Start AND
   NOT(Local_Status.Busy OR Local_Status.Done OR Local_Status.Error) THEN
   Local_Status.Busy:=TRUE;
   Local_State:=10; //10: Initialization processing
END_IF;
```

```
(* 1.2. Clearing the communications processing status flags
   Clear the communications processing status flags when the communications start switch
   changes to OFF while communications processing is not in progress. *)
```

```
IF NOT Input_Start AND NOT Local_Status.Busy THEN
   Local_Status.Done:=FALSE;
   Local_Status.Error:=FALSE;
END_IF;
```

```
(* 1.3. Entering the communications in progress status and shifting to each state processing *)
```

```
IF Local_Status.Busy THEN
   CASE Local_State OF
```

2. Initialization processing

(* 2. Initialization processing

-Perform initialization for the whole communications and set the parameters.

-Set the send data and initialize the receive data storage areas. *)

10:

(* 2.1. Initializing the communications instruction *)

(* 2.1.1. Initializing the addresses *)

Local_DstNetAdr.NetNo:=USINT#16#00; // Set destination network address.

Local_DstNetAdr.NodeNo:=USINT#00; // Set local node address.

Local_DstNetAdr.UnitNo:=BYTE#16#00; // Set Unit number address

(* 2.1.2. Initializing the command data and receive data storage areas *)

Clear(Local_cmddata);

Clear(Local_recvdata);

Clear(Output_recvCWFdata);

(* 2.1.3. Initializing the parameters *)

Local_Option.isNonResp:=FALSE; // Set response required/not required setting

Local_Option.TimeOut:=UINT#0; // Timeout time

Local_Option.Retry:=USINT#0; // Retry count

(* 2.1.4. Executing the initialization of SendCmd instruction *)

SendCmd_instance(
Execute:=FALSE,
DstNetAdr:=Local_DstNetAdr,
CommPort:=_NONE,
CmdDat:=Local_cmddata[0],
CmdSize:=UINT#0,
RespDat:=Local_recvdata[0],
Option:=Local_Option);

(* 2.2. Initializing the communications instruction execution flag *)

Local_ExecFlg:=FALSE;

(* 2.3. Initializing the error code storage areas *)

Output_TransErrCode:=WORD#16#FFFF;

Output_CWFErrCode1:=WORD#16#FFFF;

Output_CWFErrCode2:=WORD#16#FFFF;

Output_CmdErrorID:=WORD#16#FFFF;

Output_CmdErrorIDEx:=DWORD#16#FFFFFFFF;

(* 2.4. Setting the SendCmd instruction control data *)

(* 2.4.1. Setting the address and port *)

Local_DstNetAdr.NetNo:=USINT#16#00; // Set destination network address Always 0

Local_DstNetAdr.NodeNo:=USINT#00; // Set local node address Always 0

Local_DstNetAdr.UnitNo:=BYTE#16#80; // Unit number address setting=80h+4hxUnit number

// (Unit number 0, port number 1)

Local_CommPort:=_NONE; // Set serial port _NONE only

```

(* 2.4.2. Setting the parameters *)
Local_Option.isNonResp:=FALSE; // Set response required/not required setting: Required
Local_Option.TimeOut:=UINT#0; // Timeout time (default 2.0s)
Local_Option.Retry:=USINT#3; // Retry count: 3 times

(* 2.5. Setting the send variables *)
(* 2.5.1. Setting the CompoWay/F communications command *)
Local_cmddata[0]:=BYTE#16#28;
Local_cmddata[1]:=BYTE#16#03;

(* 2.5.2. Setting the CompoWay/F command *)
CWFCmdsSet_instance(
  Execute:=TRUE,
  CWFdata:=Local_cmdCWFdata,
  Done=>Local_InitialSettingOK);

(*2.5.3. Converting the send data from string to BYTE array and setting the size *)
Local_sendSize:=UINT#2+StringToAry(Local_cmdCWFdata,Local_cmddata[2]);

(* 2.6. Initialization setting end processing *)
IF Local_InitialSettingOK THEN
  Local_State:=11; //11: CompoWay/F communications processing
ELSE
  Local_Status.Busy:=FALSE;
  Local_Status.Error:=TRUE;
  Local_State:=0; //0: Communications not in progress status
END_IF;

```

3. CompoWay/F communications processing

```
(* 3.CompoWay/F communications processing
-Execute the communications processing from the specified serial port. *)
11:
(*3.1. Normal receive processing *)
IF SendCmd_instance.Done THEN
  (*3.1.1. Clearing the command error codes *)
  Output_CmdErrorID:=WORD#16#0000;
  Output_CmdErrorIDEx:=DWORD#16#0000000;

  (*3.1.2. Converting the receive data from BYTE array to STRING *)
  Output_recvCWFData:=
    AryToString(Local_RecvData[4],SizeOfAry(Local_recvdata)-UINT#4);

  (*3.1.3. Obtaining the end code and response code *)
  Output_CWFErrCode1:=STRING_TO_WORD(MID(Output_recvCWFData,2,5));
  Output_CWFErrCode2:=STRING_TO_WORD(MID(Output_recvCWFData,4,11));

  (*3.1.4. Checking the end code and response code *)
  IF (Output_CWFErrCode1 = WORD#16#0000 AND
      Output_CWFErrCode2 = WORD#16#0000) THEN
    Output_TransErrCode:=WORD#16#0000;
    Local_Status.Busy:=FALSE;
    Local_Status.Done:=TRUE;
  ELSE
    Output_TransErrCode:=WORD#16#1000;
    Local_Status.Busy:=FALSE;
    Local_Status.Error:=TRUE;
  END_IF;

  Local_State:=0; //0: Communications not in progress status

(*3.2. Error receive processing *)
ELSIF SendCmd_instance.Error THEN
  (*3.2.1. Setting the command error codes *)
  Output_CmdErrorID:=SendCmd_instance.ErrorID;
  Output_CmdErrorIDEx:=SendCmd_instance.ErrorIDEx;
```

```

(*3.2.2. Destination node busy or response timeout error *)
IF Output_CmdErrorIDEx = DWORD#16#00000204 OR
   Output_CmdErrorIDEx = DWORD#16#00000205 THEN
  IF J01_P1_TransErr THEN
    Output_TransErrCode:=J01_P1_TransErrSta;
    Local_Status.Busy:=FALSE;
    Local_Status.Error:=TRUE;
    Local_ExecFlg:=FALSE;
    Local_State:=0; //0: Communications not in progress status
  END_IF;
ELSE
  Output_TransErrCode:=WORD#16#2000;
  Local_Status.Busy:=FALSE;
  Local_Status.Error:=TRUE;
  Local_ExecFlg:=FALSE;
  Local_State:=0; //0: Communications not in progress status
END_IF;

```

```

(*3.3. Starting the communications instruction *)
(*3.3.1. Setting the communications instruction execution flag *)
ELSIF _Port_isAvailable AND NOT(SendCmd_instance.Busy) THEN
  Local_ExecFlg:=TRUE;
END_IF;

```

```

(*3.3.2. Executing the communications instruction *)
SendCmd_instance(
  Execute:=Local_ExecFlg,
  DstNetAdr:=Local_DstNetAdr,
  CommPort:=Local_CommPort,
  CmdDat:=Local_cmddata[0],
  CmdSize:=Local_sendSize,
  RespDat:=Local_recvdata[0],
  Option:=Local_Option);

```

4. Processing number error process

```

ELSE
(* 4. Processing number error process
  -Error process for nonexistent processing number *)
  Output_TransErrCode:=WORD#16#0100;
  Local_Status.Busy:=FALSE;
  Local_Status.Error:=TRUE;
  Local_State:=0; //0: Communications not in progress status

END_CASE;

END_IF;

```

9.5.3. Detailed Description of the Function Block

The user-defined function block is shown below.

The code which you need to edit according to the destination device is indicated by the red frames on the function block below.

●CWFCmdsSet function block (CompoWay/F communications send command setting)

Instruction	Name	ST expression
CWFCmdsSet	CompoWay/F communications send command setting	CWFCmdsSet_instance(Execute, CWFdata, Done);

[Internal variables]

Variable name	Data type	Description
NodeNo	STRING[3]	Node No.: Sets the Unit No. of the destination device.
SubAddress	STRING[3]	Subaddress: (Not used)
SID	STRING[2]	SID: (Not used)
MRCSRC	STRING[5]	Command (MRC+SRC): Sets the command code to use.
SendText	STRING[128]	Text: Sets the data according to the command code.

[Input/output]

Variable name	I/O	Data type	内容
Execute	Input	BOOL	Execution flag: The function block is executed when this flag is TRUE and it is stopped when this flag is FALSE
CWFdata	In-out	STRING[256]	CompoWay/F send data: Sets the command sent to the destination device.
Done	Output	BOOL	Normal end: Changes to TRUE after an execution of the function block.
Busy	Output	BOOL	Busy
Error	Output	BOOL	Error end
ErrorID	Output	WORD	Error information
ErrorIDEx	Output	DWORD	Error information

Not used
(Not used in this program.)

[External variables]

None

[Program]

```
(* =====
  Name: NJ-series CompoWay/F communications
        send command setting function block
  Applicable device: OMRON Corporation CompoWay/F-compatible device
  Version: V1.00 New release January 17, 2012
  (C)Copyright OMRON Corporation 2012 All Rights Reserved.
  ===== *)
```

IF Execute THEN

```
(* Destination device node address=01
  MRC=05,SRC=03: Read Unit Attributes *)
```

```
NodeNo:='01';           // Address=01
SubAddress:='00';       // Subaddress
SID:='0';               // SID
MRCSRC:='0503';        // MRC,SRC
SendText:='';           // No send data
```

```
(* SendCmd CompoWay/F format send data setting
  Node No.+Subaddress+SID+Command(MRC,SRC)+Send data*)
CWFdata:=CONCAT(NodeNo,SubAddress,SID,MRCSRC,SendText);
```

```
Done:=TRUE;
```

```
END_IF;
RETURN;
```

9.6. Timing Charts

This section explains the timing charts of the program.

The definitions of the timing chart patterns are as follows:

Pattern	Normal end	Error end (1) SendCmd instruction error	Error end (2) Destination device error
Command	Normal	Error	Normal
Destination device	Normal	Normal or error	Error
Response	Yes	None	Yes

■ Normal end

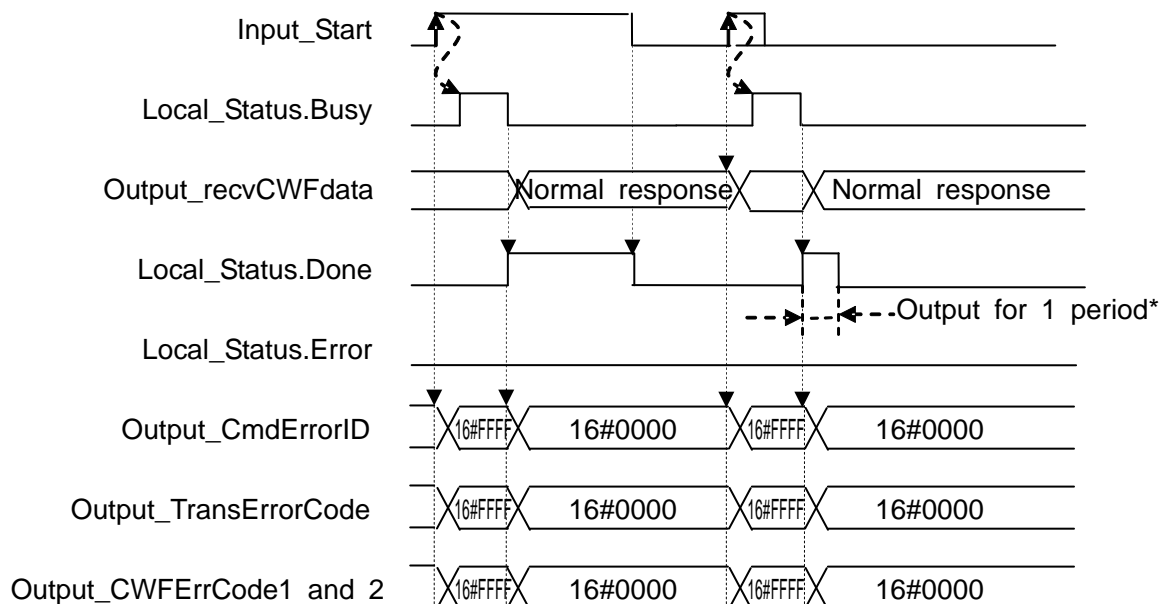

■ Error end

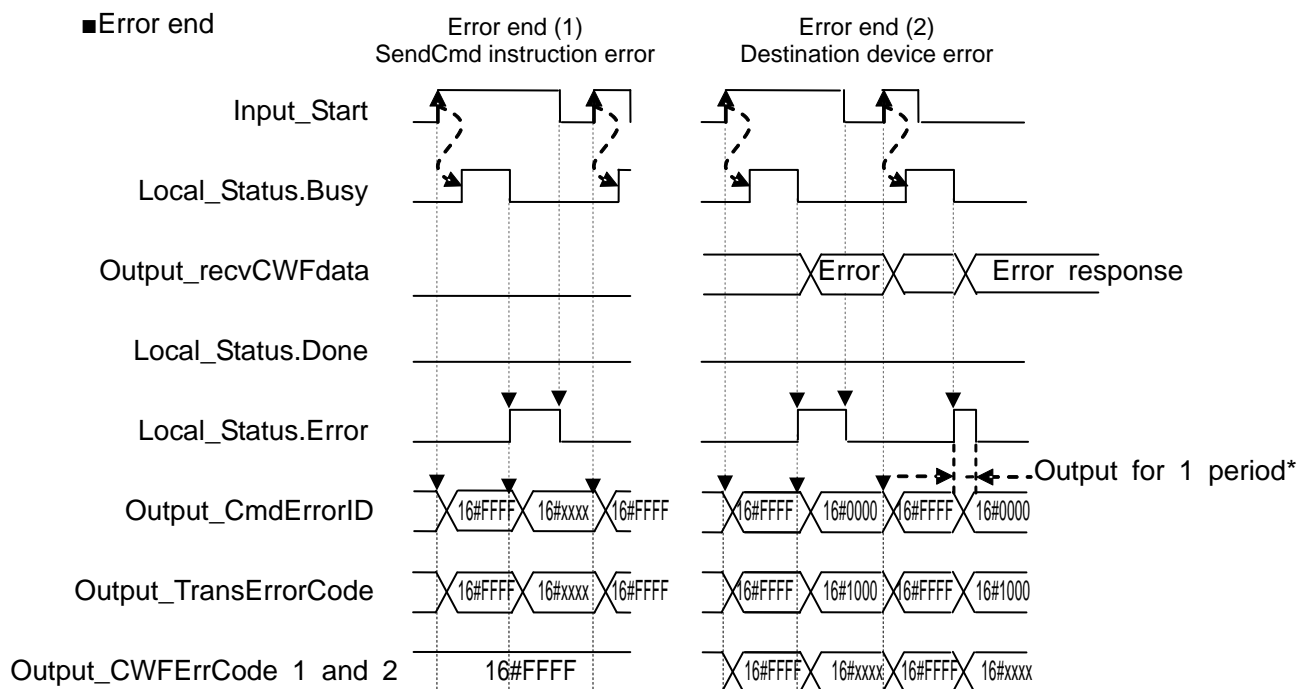

*If *Input_Start* changes from TRUE to FALSE during execution (Busy=ON), a normal end or an error end is output for 1 period after the processing is completed (Busy=OFF).

9.7. Error Process

The errors that occur when this program is executed are shown below.

9.7.1. SendCmd Instruction Errors

The error codes that are generated for errors in the SendCmd instruction are shown below.

- SendCmd instruction error code [Output_CmdErrorID, Output_CmdErrorIDEx]

An error code of *ErrorID* is stored in *Output_CmdsErrorID* and an error code of *ErrorIDEx* is stored in *Output_CmdsErrorIDEx*.

[Output_CmdErrorID]

Value	Error description
16#0400	An input parameter for an instruction exceeded the valid range for an input variable.
16#0406	The data position specified for an instruction exceeded the data area range.
16#0407	The results of instruction processing exceeded the data area range of the output parameter.
16#0800	An error occurred when a FINS command was sent or received. The details are stored in Output_CmdErrorIDEx.
16#0801	The port is being used.



Additional Information

For details on the errors, refer to *A-3 Error Code Details* in *Appendices of the NJ-series Instructions Reference Manual* (Cat. No. W502).

For troubleshooting, refer to *9-3 Troubleshooting* of in the *CJ-series Serial Communications Units Operation Manual for NJ-series CPU Unit* (Cat. No. W494).

[Output_CmdErrorIDEx]

Value	Error	Correction
16#00000101	The local node is not part of the network.	Make the local node part of the network.
16#00000105	The IP address of the local node is out of range.	Set the rotary switches on the Serial Communications Unit correctly.
16#00000106	The IP address of the local node is also used by another node in the network.	Change one of the node addresses that are duplicated.
16#00000202	A Unit with the specified unit address does not exist at the destination.	Correctly set the unit address for the destination network address.
16#00000205	A response timeout occurred.	Check the settings of the communications parameters.
16#00000301	A Communications Controller Error occurred.	Refer to the operation manual for the relevant Unit and make suitable corrections.
16#00000304	The unit number setting is not correct.	Set the rotary switches on the Serial Communications Unit correctly.
16#00000401	The command that was sent is not supported.	Set the command string correctly.
16#00000402	The Unit model or version is not supported.	Check the Unit model and version.
16#00001001	The command is too long.	Set the command string correctly.
16#00001002	The command is too short.	Set the command string correctly.
16#00001003	The number of write elements that is specified in the command does not agree with the number of write data.	Specify the same number of write elements and write data.
16#00001004	The command format is incorrect.	Set the command string correctly.
16#0000110B	The response is too long.	Set the number of elements in the command string correctly.
16#0000110C	This is another parameter error.	Set the command string correctly.
16#00002202	The operating mode is wrong.	Check the operating mode.
16#00002502	There is an error in the part of memory for processing.	Transfer the correct data to memory.
16#00002503	The registered I/O Unit configuration does not agree with the physical Unit configuration.	Check the I/O Unit configuration.
16#00002504	There are too many local or remote I/O points.	Set the number of local and remote I/O points correctly.
16#00002505	An error occurred in a data transmission between the CPU Unit and a CPU Bus Unit.	Check the Unit and the Connecting Cable. After removing the error, execute a command to reset the error.
16#00002506	The same rack number, unit number, or I/O address is set more than once.	Correct the settings so that each number is unique.
16#00002507	An error occurred in a data transmission between the CPU Unit and an I/O Unit.	Check the Unit and the Connecting Cable. After removing the error, execute a command to reset the error.
16#00002509	There is an error in SYSMAC BUS/2 data transmission.	Check the Unit and the Connecting Cable. After removing the error, execute a command to reset the error.
16#0000250A	An error occurred in a CPU Bus Unit data transmission.	Check the Unit and the Connecting Cable. After removing the error, execute a command to reset the error.
16#0000250D	The same word setting is used more than once.	Set the I/O words correctly.
16#00002510	The end station setting is wrong.	Set the end station correctly.

- Transmission error status [Output_TransErrCode

The transmission error status (*J01_P1_TransErrSta*) is stored in *Output_TransErrCode*.

When a SendCmd instruction error, a destination device error and a processing number error occur, bits 8, 12 and 13 will change to TRUE, respectively.

[Each bit content of transmission error status]

Bit	Description
15	TRUE: Transmission error FALSE: No transmission error
14	(Not used)
13	TRUE: SendCmd instruction error FALSE: Normal
12	TRUE: Destination device error FALSE: Normal
9 to 11	(Not used)
8	TRUE: Processing number error FALSE: Normal
7	TRUE: FCS check error FALSE: FCS check normal
6	(Not used)
5	TRUE: Timeout error FALSE: Normal
4	TRUE: Overrun error FALSE: Normal
3	TRUE: Framing error FALSE: Normal
2	TRUE: Parity error FALSE: Normal
0 and 1	(Not used)

16#0000 and 16#FFFF indicate the following status.

Value	Description
16#0000	Normal end
16#FFFF	Initialized

10. Revision History

Revision code	Date of revision	Revision reason and revision page
01	Jun. 25, 2013	First edition

OMRON Corporation Industrial Automation Company

Tokyo, JAPAN

Contact: www.ia.omron.com

Regional Headquarters

OMRON EUROPE B.V.

Wegalaan 67-69-2132 JD Hoofddorp
The Netherlands

Tel: (31)2356-81-300/Fax: (31)2356-81-388

OMRON ELECTRONICS LLC

One Commerce Drive Schaumburg,
IL 60173-5302 U.S.A.

Tel: (1) 847-843-7900/Fax: (1) 847-843-7787

OMRON ASIA PACIFIC PTE. LTD.

No. 438A Alexandra Road # 05-05/08 (Lobby 2),
Alexandra Technopark,
Singapore 119967

Tel: (65) 6835-3011/Fax: (65) 6835-2711

OMRON (CHINA) CO., LTD.

Room 2211, Bank of China Tower,
200 Yin Cheng Zhong Road,
PuDong New Area, Shanghai, 200120, China

Tel: (86) 21-5037-2222/Fax: (86) 21-5037-2200

Authorized Distributor:

© OMRON Corporation 2013 All Rights Reserved.
In the interest of product improvement,
specifications are subject to change without notice.

Cat. No. **P556-E1-01**

0911(-)