

Vision Sensor FH/FHV Series Vision System

Processing Item Function Reference Manual

FH-2□□□/ FH-2□□□-□□

FH-5□□□/ FH-5□□□-□□

FH-L□□□/ FH-L□□□-□□

FHV7□-□□□□□-C

FHV7□-□□□□□-S□□/ FHV7□-□□□□□-S□□-□□

FHV7□-□□□□□-H□□/ FHV7□-□□□□□-H□□-□□



NOTE

- All rights reserved.
- No part of this publication may be reproduced, stored in a retrieval system, or transmitted, in any form, or by any means, mechanical, electronic, photocopying, recording, or otherwise, without the prior written permission of OMRON.
- No patent liability is assumed with respect to the use of the information contained herein. Moreover, because OMRON is constantly striving to improve its high-quality products, the information contained in this manual is subject to change without notice. Every precaution has been taken in the preparation of this manual. Nevertheless, OMRON assumes no responsibility for errors or omissions.

Neither is any liability assumed for damages resulting from the use of the information contained in this publication.

Trademarks

- Sysmac and SYSMAC are trademarks or registered trademarks of OMRON Corporation in Japan and other countries for OMRON factory automation products.
- This software is based in part on the work of the Independent JPEG Group.
- Microsoft, Windows, Windows Vista, Excel, and Visual Basic are either registered trademarks or trademarks of Microsoft Corporation in the United States and other countries.
- Intel, Core and Pentium are trademarks of Intel Corporation in the U.S. and/or other countries.
- EtherCAT® is registered trademark and patented technology, licensed by Beckhoff Automation GmbH, Germany.
- ODVA, CIP, CompoNet, DeviceNet, and EtherNet/IP are trademarks of ODVA.
- The SD, SDHC, microSD, and microSDHC logos are trademarks of SD-3C, LLC.



- QR Code is a registered trademark of DENSO WAVE INCORPORATED.
- MELSEC is a registered trademarks of Mitsubishi Electric Corporation.

Other company names and product names in this document are the trademarks or registered trademarks of their respective companies.

Copyrights

Microsoft product screen shots reprinted with permission from Microsoft Corporation.

Introduction

Thank you for purchasing the FH series/FHV series.

This manual contains information that is necessary to use the FH series/FHV series.

Please read this manual and make sure you understand the functionality and performance of the FH series/FHV series before you attempt to use it in a control system.

Keep this manual in a safe place where it will be available for reference during operation.

Intended Audience

This manual is intended for the following personnel, who must also have knowledge of electrical systems (an electrical engineer or the equivalent).

- Personnel in charge of introducing FA systems.
- Personnel in charge of designing FA systems.
- Personnel in charge of installing and maintaining FA systems.
- Personnel in charge of managing FA systems and facilities.

Applicable Products

This manual covers the following products.

- FH-2□□□
- FH-2□□□-□□
- FH-5□□□
- FH-5□□□-□□
- FH-L□□□
- FH-L□□□-□□
- FHV7□-□□□□

Part of the specifications and restrictions are given in other manuals. Refer to *Relevant Manuals* on page 2 and *Related Manuals* on page 31.

Relevant Manuals

The following table provides the relevant manuals for the FH series/FHV series.

Read all of the manuals that are relevant to your system configuration and application before you use the FH series/FHV series.

Purpose of use	Manual							
	Basic information			FHV Series Smart Camera Setup Manual	FH/FHV Series Vision System Processing Item Function Reference Manual	FH Series Vision System Macro Customize Functions Programming Manual	FH/FHV Series Vision System User's Manual for Communications Settings	FH/FHV Series Vision System Operation Manual for Systemac Studio
	FH/FHV Series Vision System User's Manual	FH Series Vision System Hardware Setup Manual						
Overview of FH series	●	●						
Overview of FHV series	●		●					
Setup and Wiring								
EtherCAT								
EtherNet/IP								
PROFINET		●	●					
Ethernet								
RS-232C								
Parallel interface								
Setup the communication setting of Sensor Controller								●
EtherCAT								
EtherNet/IP	●	●	●				●	
PROFINET								
Ethernet								
RS-232C								
Parallel interface								
Setup the Sensor Controller								●
EtherCAT								
EtherNet/IP								
PROFINET	●						●	
Ethernet								
RS-232C								
Parallel interface								

Purpose of use	Manual						
	Basic information			FH/FHV Series Vision System Processing Item Function Reference Manual	FH Series Vision System Macro Customize Functions Programming Manual	FH/FHV Series Vision System User's Manual for Communications Settings	FH/FHV Series Vision System Operation Manual for Sysmac Studio
	FH/FHV Series Vision System User's Manual	FH Series Vision System Hardware Setup Manual	FHV Series Smart Camera Setup Manual				
Create and Set the Scene							●
EtherCAT							
EtherNet/IP							
PROFINET	●			●			
Ethernet							
RS-232C							
Parallel interface							
Optimizing the Scene Flow							
EtherCAT							
EtherNet/IP							
PROFINET				●	●		
Ethernet							
RS-232C							
Parallel interface							
Connecting the Controller							●
EtherCAT							
EtherNet/IP							
PROFINET	●	●	●			●	
Ethernet							
RS-232C							
Parallel interface							
Using Helpful Functions							●
EtherCAT							
EtherNet/IP							
PROFINET	●						
Ethernet							
RS-232C							
Parallel interface							
Troubleshooting and Problem Solving	●						

Manual Structure

Page Structure

The following page structure is used in this manual.

The diagram illustrates the structure of a manual page. On the left, labels point to various elements: 'Level 2 heading' points to '4-3 Mounting Units'; 'Level 3 heading' points to '4-3-1 Connecting Controller Components'; 'A step in a procedure' points to step '1'; 'Special information' points to a warning icon and 'Precautions for Correct Use'; 'Manual name' points to 'NJ-series CPU Unit Hardware User's Manual (W500)'. On the right, labels point to 'Level 1 heading' (4 Installation and Wiring), 'Level 2 heading' (4-3 Mounting Units), 'Level 3 heading' (4-3-1 Connecting Controller Components), and 'Page tab' (4). The page content includes a title bar '4 Installation and Wiring', a section header '4-3 Mounting Units', a sub-section header '4-3-1 Connecting Controller Components', a paragraph of text, two numbered steps with diagrams, a 'Precautions for Correct Use' section with a warning icon, and a footer 'NJ-series CPU Unit Hardware User's Manual (W500) 4-9'.

Note This illustration is provided only as a sample. It may not literally appear in this manual.

Special Information

Special information in this manual is classified as follows:



Precautions for Safe Use

Precautions on what to do and what not to do to ensure safe usage of the product.



Precautions for Correct Use

Precautions on what to do and what not to do to ensure proper operation and performance.



Additional Information

Additional information to read as required.

This information is provided to increase understanding or make operation easier.

Conventions Used in This Manual

Use of Quotation Marks and Brackets

In this manual, menus and other items are indicated as follows.

Bold	Menu	Indicates the menu bar, button, and icon.
<i>Italic</i>	Item name	Indicates the item and area names displayed on the screen.

Sections in This Manual

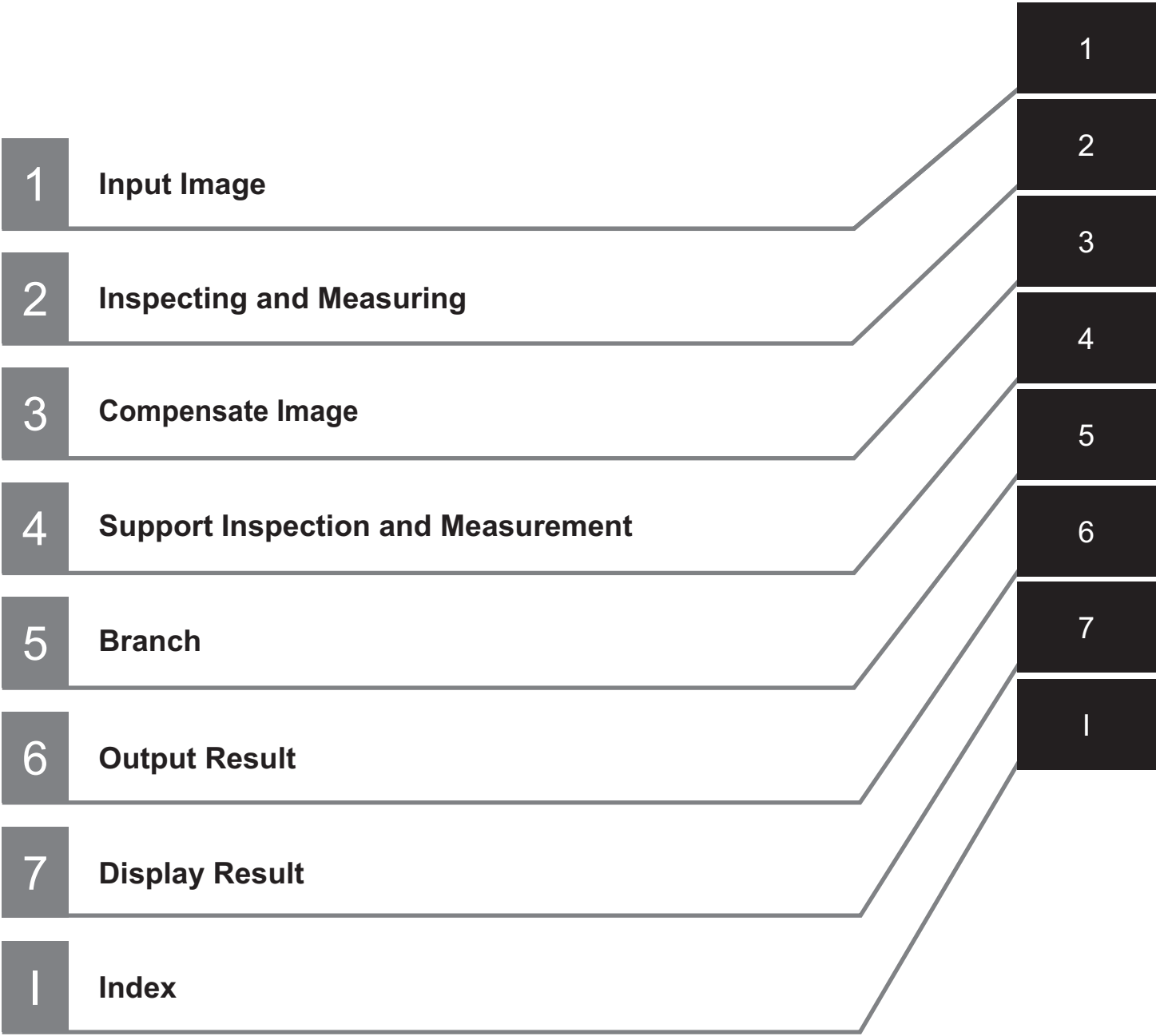

CONTENTS

Introduction	1
Intended Audience	1
Applicable Products	1
Relevant Manuals	2
Manual Structure	4
Page Structure	4
Special Information	5
Conventions Used in This Manual	5
Sections in This Manual	7
Terms and Conditions Agreement	24
Warranty, Limitations of Liability	24
Application Considerations	25
Disclaimers	25
Safety Precautions	27
Precautions for Safe Use	28
Precautions for Correct Use	29
Regulations and Standards	30
Related Manuals	31
Revision History	33

Section 1 Input Image

1-1 Camera Image Input	1-3
1-1-1 Settings Flow (Camera Image Input)	1-4
1-1-2 Select Camera (Camera Image Input)	1-5
1-1-3 Camera Settings (Camera Image Input)	1-6
1-1-4 Screen Adjustment Settings (Camera Image Input)	1-11
1-1-5 White Balance (Camera Image Input)	1-19
1-1-6 Calibration (Camera Image Input)	1-21
1-1-7 Additional Explanation (Camera Image Input)	1-26
1-1-8 External Reference Tables (Camera Image Input)	1-27
1-2 Camera Image Input FH	1-28
1-2-1 Settings Flow (Camera Image Input FH)	1-29
1-2-2 Select Camera (Camera Image Input FH)	1-30
1-2-3 Camera Settings (Camera Image Input FH)	1-31
1-2-4 Assigning Multiple Electronic Flashes to a Camera	1-40
1-2-5 Screen Adjustment Settings (Camera Image Input FH)	1-41
1-2-6 White Balance (Camera Image Input FH)	1-56
1-2-7 Calibration (Camera Image Input FH)	1-58
1-2-8 External Reference Tables (Camera Image Input FH)	1-64
1-3 Camera Image Input FHV	1-66
1-3-1 Settings Flow (Camera Image Input FHV)	1-67
1-3-2 Camera Selection (Camera Image Input FHV)	1-68

1-3-3	Camera Settings (Camera Image Input FHV)	1-68
1-3-4	Screen Adjustment Settings (Camera Image Input FHV)	1-75
1-3-5	White Balance (Camera Image Input FHV).....	1-82
1-3-6	Calibration (Camera Image Input FHV).....	1-83
1-3-7	Lens Adjustment (Camera Image Input FHV)	1-89
1-3-8	External Reference Tables (Camera Image Input FHV).....	1-91
1-4	Camera Image Input HDR (using FH Controller).....	1-93
1-4-1	Settings Flow (Camera Image Input HDR (using FH Controller))	1-94
1-4-2	Camera Settings (Camera Image Input HDR (using FH Controller))	1-95
1-4-3	HDR Settings (Camera Image Input HDR (using FH Controller))	1-100
1-4-4	Bright Adjust Setting (Camera Image Input HDR (using FH Controller))	1-101
1-4-5	Camera Model (Camera Image Input HDR (using FH Controller))	1-102
1-4-6	External Reference Tables (Camera Image Input HDR (using FH Controller)).....	1-103
1-5	Camera Image Input HDR (using FHV Controller).....	1-105
1-5-1	Settings Flow (Camera Image Input HDR (using FHV Controller)).....	1-106
1-5-2	Camera Settings (Camera Image Input HDR (using FHV Controller)).....	1-107
1-5-3	HDR Settings (Camera Image Input HDR (using FHV Controller)).....	1-110
1-5-4	Bright Adjust Setting (Camera Image Input HDR (using FHV Controller)).....	1-112
1-5-5	Lens Adjustment (Camera Image Input HDR (using FHV Controller)).....	1-113
1-5-6	External Reference Tables (Camera Image Input HDR (using FHV Controller))	1-114
1-6	Camera Image Input HDR Lite	1-116
1-6-1	Settings Flow (Camera Image Input HDR Lite).....	1-117
1-6-2	Camera Settings (Camera Image Input HDR Lite).....	1-118
1-6-3	HDR Settings (Camera Image Input HDR Lite).....	1-118
1-6-4	Screen Adjust (Camera Image Input HDR Lite).....	1-119
1-6-5	External Reference Tables (Camera Image Input HDR Lite)	1-120
1-7	Photometric Stereo Image Input (using FH Controller).....	1-122
1-7-1	Settings Flow (Photometric Stereo Image Input (using FH Controller)).....	1-124
1-7-2	Image Input Settings (Photometric Stereo Image Input (using FH Controller)).....	1-125
1-7-3	Screen Adjust (Photometric Stereo Image Input (using FH Controller))	1-133
1-7-4	Filter Setting (Photometric Stereo Image Input (using FH Controller))	1-138
1-7-5	Output Image (Photometric Stereo Image Input (using FH Controller)).....	1-141
1-7-6	White Balance (Photometric Stereo Image Input (using FH Controller))	1-142
1-7-7	Calibration (Photometric Stereo Image Input (using FH Controller))	1-142
1-7-8	Camera Model (Photometric Stereo Image Input (using FH Controller))	1-142
1-7-9	External Reference Tables (Photometric Stereo Image Input (using FH Controller))	1-143
1-8	Photometric Stereo Image Input (using FHV Controller)	1-144
1-8-1	Settings Flow (Photometric Stereo Image Input (using FHV Controller)).....	1-146
1-8-2	Image Input Settings (Photometric Stereo Image Input (using FHV Controller))	1-147
1-8-3	Screen Adjust (Photometric Stereo Image Input (using FHV Controller)).....	1-155
1-8-4	Filter (Photometric Stereo Image Input (using FHV Controller))	1-160
1-8-5	Output Image (Photometric Stereo Image Input (using FHV Controller))	1-164
1-8-6	White Balance (Photometric Stereo Image Input (using FHV Controller)).....	1-164
1-8-7	Calibration (Photometric Stereo Image Input (using FHV Controller))	1-164
1-8-8	Lens Adjustment (Photometric Stereo Image Input (using FHV Controller))	1-164
1-8-9	Camera Model (Photometric Stereo Image Input (using FHV Controller)).....	1-166
1-8-10	External Reference Tables (Photometric Stereo Image Input (using FHV Controller))	1-166
1-9	Camera Switching.....	1-167
1-9-1	Camera Selection (Camera Switching)	1-167
1-9-2	Additional Explanation (Camera Switching)	1-168
1-9-3	External Reference Tables (Camera Switching).....	1-168
1-10	Measurement Image Switching	1-169
1-10-1	Parameter Settings (Measurement Image Switching).....	1-169
1-10-2	Key Points for Test Measurement and Adjustment (Measurement Image Switching)	1-170
1-10-3	External Reference Tables (Measurement Image Switching)	1-171
1-11	Multi-trigger Imaging	1-172
1-11-1	Mode and Timeout (Multi-Trigger Imaging)	1-173
1-11-2	Key Points for Adjustment.....	1-174
1-11-3	External Reference Tables (Multi-Trigger Imaging).....	1-175
1-12	Multi-trigger Imaging Task	1-176

Section 2 Inspecting and Measuring

2-1	Search	2-8
2-1-1	Settings Flow (Search).....	2-9
2-1-2	Model Registration (Search).....	2-9
2-1-3	Region Setting (Search).....	2-12
2-1-4	Detection Point (Search).....	2-13
2-1-5	Reference Setting (Search).....	2-14
2-1-6	Measurement Parameters (Search).....	2-16
2-1-7	Output Parameters (Search).....	2-18
2-1-8	Key Points for Test Measurement and Adjustment (Search).....	2-18
2-1-9	Measurement Results for Which Output Is Possible (Search).....	2-20
2-1-10	External Reference Tables (Search).....	2-21
2-2	Search II	2-24
2-2-1	Settings Flow (Search II).....	2-25
2-2-2	Model Registration (Search II).....	2-26
2-2-3	Region Setting (Search II).....	2-29
2-2-4	Detection Point (Search II).....	2-29
2-2-5	Reference Setting (Search II).....	2-30
2-2-6	Measurement Parameters (Search II).....	2-31
2-2-7	Output Parameters (Search II).....	2-33
2-2-8	Key Points for Test Measurement and Adjustment (Search II).....	2-33
2-2-9	Measurement Results for Which Output Is Possible (Search II).....	2-35
2-2-10	External Reference Tables (Search II).....	2-36
2-3	Flexible Search	2-39
2-3-1	Settings Flow (Flexible Search).....	2-40
2-3-2	Model Registration (Flexible Search).....	2-41
2-3-3	Region Setting (Flexible Search).....	2-43
2-3-4	Measurement Parameters (Flexible Search).....	2-44
2-3-5	Output Parameters (Flexible Search).....	2-45
2-3-6	Key Points for Test Measurement and Adjustment (Flexible Search).....	2-46
2-3-7	Measurement Results for Which Output Is Possible (Flexible Search).....	2-47
2-3-8	External Reference Tables (Flexible Search).....	2-48
2-4	Sensitive Search	2-50
2-4-1	Settings Flow (Sensitive Search).....	2-50
2-4-2	Model Registration (Sensitive Search).....	2-52
2-4-3	Region Setting (Sensitive Search).....	2-55
2-4-4	Detection Point (Sensitive Search).....	2-55
2-4-5	Reference Setting (Sensitive Search).....	2-57
2-4-6	Measurement Parameters (Sensitive Search).....	2-59
2-4-7	Output Parameters (Sensitive Search).....	2-60
2-4-8	Key Points for Test Measurement and Adjustment (Sensitive Search).....	2-60
2-4-9	Measurement Results for Which Output Is Possible (Sensitive Search).....	2-62
2-4-10	External Reference Tables (Sensitive Search).....	2-63
2-5	ECM Search	2-67
2-5-1	Settings Flow (ECM Search).....	2-68
2-5-2	Model Registration (ECM Search).....	2-69
2-5-3	Error Model Registration (ECM Search).....	2-72
2-5-4	Region Setting (ECM Search).....	2-72
2-5-5	Detection Point (ECM Search).....	2-73
2-5-6	Reference Setting (ECM Search).....	2-74
2-5-7	Measurement Parameters (ECM Search).....	2-77
2-5-8	Output Parameters (ECM Search).....	2-78
2-5-9	Key Points for Test Measurement and Adjustment (ECM Search).....	2-79
2-5-10	Measurement Results for Which Output Is Possible (ECM Search).....	2-80
2-5-11	External Reference Tables (ECM Search).....	2-81
2-6	EC Circle Search	2-84
2-6-1	Settings Flow (EC Circle Search).....	2-85
2-6-2	Circle Setting (EC Circle Search).....	2-86
2-6-3	Region Setting (EC Circle Search).....	2-87
2-6-4	Reference Setting (EC Circle Search).....	2-87

2-6-5	Color Specification (EC Circle Search)	2-89
2-6-6	Measurement Parameters (EC Circle Search).....	2-89
2-6-7	Output Parameters (EC Circle Search).....	2-91
2-6-8	Key Points for Test Measurement and Adjustment (EC Circle Search)	2-92
2-6-9	Measurement Results for Which Output Is Possible (EC Circle Search).....	2-93
2-6-10	External Reference Tables (EC Circle Search)	2-93
2-7	Shape Search II	2-96
2-7-1	Settings Flow (Shape Search II)	2-97
2-7-2	Model Registration (Shape Search II)	2-98
2-7-3	Region Setting (Shape Search II)	2-100
2-7-4	Detection Point (Shape Search II).....	2-100
2-7-5	Reference Setting (Shape Search II)	2-101
2-7-6	Measurement Parameters (Shape Search II)	2-103
2-7-7	Output Parameters (Shape Search II).....	2-105
2-7-8	Key Points for Test Measurement and Adjustment (Shape Search II)	2-106
2-7-9	Measurement Results for Which Output Is Possible (Shape Search II).....	2-107
2-7-10	External Reference Tables (Shape Search II).....	2-108
2-8	Shape Search III	2-111
2-8-1	Settings Flow (Shape Search III)	2-112
2-8-2	Model (Shape Search III)	2-113
2-8-3	Region Setting (Shape Search III)	2-120
2-8-4	Detection Point (Shape Search III).....	2-121
2-8-5	Reference Setting (Shape Search III)	2-122
2-8-6	Measurement parameter (Shape Search III).....	2-124
2-8-7	Output Parameters (Shape Search III).....	2-128
2-8-8	Key Points for Test Measurement and Adjustment (Shape Search III)	2-129
2-8-9	Measurement Results for Which Output is Possible (Shape Search III).....	2-131
2-8-10	External Reference Tables (Shape Search III).....	2-132
2-9	Ec Corner	2-138
2-9-1	Settings Flow (Ec Corner)	2-138
2-9-2	Region Setting (Ec Corner)	2-139
2-9-3	Reference Setting (Ec Corner).....	2-140
2-9-4	Line Extraction (Ec Corner).....	2-141
2-9-5	Corner Extraction (Ec Corner).....	2-143
2-9-6	Measurement Parameters (Ec Corner)	2-145
2-9-7	Output Parameters (Ec Corner)	2-146
2-9-8	Key Points for Test Measurement and Adjustment (Ec Corner).....	2-147
2-9-9	Measurement Results for Which Output Is Possible (Ec Corner)	2-148
2-9-10	External Reference Tables (Ec Corner)	2-148
2-10	Ec Cross	2-152
2-10-1	Settings Flow (Ec Cross).....	2-153
2-10-2	Region Setting (Ec Cross).....	2-154
2-10-3	Reference Setting (Ec Cross)	2-155
2-10-4	Line Extraction (Ec Cross)	2-156
2-10-5	Cross Extraction (Ec Cross).....	2-158
2-10-6	Measurement Parameters (Ec Cross).....	2-159
2-10-7	Output Parameters (Ec Cross).....	2-160
2-10-8	Key Points for Test Measurement and Adjustment (Ec Cross)	2-161
2-10-9	Measurement Results for Which Output Is Possible (Ec Cross).....	2-162
2-10-10	External Reference Tables (Ec Cross)	2-163
2-11	Classification.....	2-166
2-11-1	Settings Flow (Classification)	2-167
2-11-2	Model Registration (Classification).....	2-168
2-11-3	Region Setting (Classification)	2-171
2-11-4	Measurement Parameters (Classification)	2-171
2-11-5	Output Parameters (Classification)	2-172
2-11-6	Key Points for Test Measurement and Adjustment (Classification).....	2-174
2-11-7	Measurement Results for Which Output Is Possible (Classification)	2-175
2-11-8	External Reference Tables (Classification)	2-176
2-12	Edge Position	2-178
2-12-1	Settings Flow (Edge Position)	2-179

2-12-2	Region Setting (Edge Position)	2-180
2-12-3	Edge Color Specification - For Color Cameras Only (Edge Position)	2-181
2-12-4	Reference Setting (Edge Position)	2-182
2-12-5	Measurement Parameters (Edge Position)	2-184
2-12-6	Output Parameters (Edge Position)	2-187
2-12-7	Key Points for Test Measurement and Adjustment (Edge Position)	2-188
2-12-8	Measurement Results for Which Output Is Possible (Edge Position)	2-189
2-12-9	External Reference Tables (Edge Position)	2-189
2-13	Edge Pitch	2-192
2-13-1	Settings Flow (Edge Pitch)	2-193
2-13-2	Region Setting (Edge Pitch)	2-194
2-13-3	Edge Color Specification - For Color Cameras Only (Edge Pitch)	2-194
2-13-4	Measurement Parameters (Edge Pitch)	2-195
2-13-5	Output Parameters (Edge Pitch)	2-197
2-13-6	Key Points for Test Measurement and Adjustment (Edge Pitch)	2-198
2-13-7	Measurement Results for Which Output Is Possible (Edge Pitch)	2-199
2-13-8	External Reference Tables (Edge Pitch)	2-199
2-14	Scan Edge Position	2-202
2-14-1	Settings Flow (Scan Edge Position)	2-203
2-14-2	Region Setting (Scan Edge Position)	2-204
2-14-3	Edge Color Specification - For Color Cameras Only (Scan Edge Position)	2-205
2-14-4	Reference Setting (Scan Edge Position)	2-206
2-14-5	Measurement Parameters (Scan Edge Position)	2-208
2-14-6	Judgment Conditions (Scan Edge Position)	2-212
2-14-7	Output Parameters (Scan Edge Position)	2-213
2-14-8	Key Points for Test Measurement and Adjustment (Scan Edge Position)	2-214
2-14-9	Measurement Results for Which Output Is Possible (Scan Edge Position)	2-215
2-14-10	External Reference Tables (Scan Edge Position)	2-216
2-15	Scan Edge Width	2-220
2-15-1	Settings Flow (Scan Edge Width)	2-221
2-15-2	Region Setting (Scan Edge Width)	2-221
2-15-3	Edge Color Specification - For Color Cameras Only (Scan Edge Width)	2-223
2-15-4	Measurement Parameters (Scan Edge Width)	2-224
2-15-5	Judgment Conditions (Scan Edge Width)	2-227
2-15-6	Output Parameters (Scan Edge Width)	2-228
2-15-7	Key Points for Test Measurement and Adjustment (Scan Edge Width)	2-228
2-15-8	Measurement Results for Which Output Is Possible (Scan Edge Width)	2-229
2-15-9	External Reference Tables (Scan Edge Width)	2-230
2-16	Circular Scan Edge Position	2-233
2-16-1	Settings Flow (Circular Scan Edge Position)	2-234
2-16-2	Region Setting (Circular Scan Edge Position)	2-235
2-16-3	Edge Color Specification - For Color Cameras Only (Circular Scan Edge Position)	2-236
2-16-4	Reference Setting (Circular Scan Edge Position)	2-237
2-16-5	Measurement Parameters (Circular Scan Edge Position)	2-239
2-16-6	Judgment Conditions (Circular Scan Edge Position)	2-242
2-16-7	Output Parameters (Circular Scan Edge Position)	2-243
2-16-8	Key Points for Test Measurement and Adjustment (Circular Scan Edge Position)	2-244
2-16-9	Measurement Results for Which Output Is Possible (Circular Scan Edge Position)	2-245
2-16-10	External Reference Tables (Circular Scan Edge Position)	2-246
2-17	Circular Scan Edge Width	2-250
2-17-1	Settings Flow (Circular Scan Edge Width)	2-250
2-17-2	Region Setting (Circular Scan Edge Width)	2-251
2-17-3	Edge Color Specification - For Color Cameras Only (Circular Scan Edge Width)	2-253
2-17-4	Measurement Parameters (Circular Scan Edge Width)	2-254
2-17-5	Judgement Conditions (Circular Scan Edge Width)	2-257
2-17-6	Output Parameters (Circular Scan Edge Width)	2-258
2-17-7	Key Points for Test Measurement and Adjustment (Circular Scan Edge Width)	2-258
2-17-8	Measurement Results for Which Output Is Possible (Circular Scan Edge Width)	2-259
2-17-9	External Reference Tables (Circular Scan Edge Width)	2-260
2-18	Intersection	2-263
2-18-1	Settings Flow (Intersection)	2-263

2-18-2	Region Setting (Intersection)	2-264
2-18-3	Edge Color Specification - For Color Cameras Only (Intersection)	2-265
2-18-4	Reference Setting (Intersection)	2-266
2-18-5	Measurement Parameters (Intersection)	2-268
2-18-6	Judgement Condition (Intersection)	2-272
2-18-7	Output Parameters (Intersection)	2-272
2-18-8	Key Points for Test Measurement and Adjustment (Intersection)	2-273
2-18-9	Measurement Results for Which Output Is Possible (Intersection)	2-274
2-18-10	External Reference Tables (Intersection)	2-275
2-19	Color Data	2-282
2-19-1	Settings Flow (Color Data)	2-283
2-19-2	Region Setting (Color Data)	2-283
2-19-3	Mask Setting (Color Data)	2-284
2-19-4	Measurement Parameters (Color Data)	2-287
2-19-5	Judgement Condition (Color Data)	2-288
2-19-6	Output parameter (Color Data)	2-290
2-19-7	Key Points for Test Measurement and Adjustment (Color Data)	2-290
2-19-8	Measurement Results for Which Output Is Possible (Color Data)	2-291
2-19-9	External Reference Tables (Color Data)	2-292
2-20	Gravity and Area	2-297
2-20-1	Settings Flow (Gravity and Area)	2-298
2-20-2	Color Specification (Gravity and Area)	2-299
2-20-3	Binarization (Gravity and Area)	2-301
2-20-4	Region Setting (Gravity and Area)	2-301
2-20-5	Mask Setting (Gravity and Area)	2-302
2-20-6	Reference Setting (Gravity and Area)	2-305
2-20-7	Measurement Parameters (Gravity and Area)	2-307
2-20-8	Output Parameters (Gravity and Area)	2-309
2-20-9	Key Points for Test Measurement and Adjustment (Gravity and Area)	2-309
2-20-10	Measurement Results for Which Output Is Possible (Gravity and Area)	2-310
2-20-11	External Reference Tables (Gravity and Area)	2-311
2-21	Labeling	2-317
2-21-1	Settings Flow (Labeling)	2-318
2-21-2	Color Specification (Labeling)	2-319
2-21-3	Binarization (Labeling)	2-321
2-21-4	Region Setting (Labeling)	2-322
2-21-5	Mask Setting (Labeling)	2-323
2-21-6	Reference Setting (Labeling)	2-326
2-21-7	Measurement Parameters (Labeling)	2-328
2-21-8	Judgement Conditions (Labeling)	2-331
2-21-9	Output Parameters (Labeling)	2-332
2-21-10	Key Points for Test Measurement and Adjustment (Labeling)	2-333
2-21-11	Measurement Results for Which Output Is Possible (Labeling)	2-334
2-21-12	External Reference Tables (Labeling)	2-335
2-22	Label Data	2-343
2-22-1	Settings Flow (Label Data)	2-344
2-22-2	Setting (Label Data)	2-344
2-22-3	Output Parameters (Label Data)	2-345
2-22-4	Key Points for Test Measurement and Adjustment (Label Data)	2-346
2-22-5	Measurement Results for Which Output Is Possible (Label Data)	2-346
2-22-6	External Reference Tables (Label Data)	2-347
2-23	Defect	2-348
2-23-1	Settings Flow (Defect)	2-349
2-23-2	Region Setting (Defect)	2-349
2-23-3	Mask Setting (Defect)	2-350
2-23-4	Measurement Parameters (Defect)	2-354
2-23-5	Output parameter (Defect)	2-357
2-23-6	Key Points for Test Measurement and Adjustment (Defect)	2-357
2-23-7	Measurement Results for Which Output Is Possible (Defect)	2-358
2-23-8	External Reference Tables (Defect)	2-359
2-24	Precise Defect	2-364

2-24-1	Settings Flow (Precise Defect)	2-365
2-24-2	Region Setting (Precise Defect)	2-365
2-24-3	Mask Setting (Precise Defect)	2-367
2-24-4	Measurement Parameters (Precise Defect)	2-370
2-24-5	Judgement Condition (Precise Defect)	2-373
2-24-6	Output parameter (Precise Defect)	2-374
2-24-7	Key Points for Test Measurement and Adjustment (Precise Defect)	2-375
2-24-8	Measurement Results for Which Output Is Possible (Precise Defect)	2-376
2-24-9	External Reference Tables (Precise Defect)	2-377
2-25	Fine Matching	2-383
2-25-1	Settings Flow (Fine Matching)	2-384
2-25-2	Model Registration (Fine Matching)	2-385
2-25-3	Difference Image Display (Fine Matching)	2-387
2-25-4	Measurement Parameters (Fine Matching)	2-388
2-25-5	Output Parameters (Fine Matching)	2-391
2-25-6	Key Points for Test Measurement and Adjustment (Fine Matching)	2-392
2-25-7	Measurement Results for Which Output Is Possible (Fine Matching)	2-393
2-25-8	External Reference Tables (Fine Matching)	2-393
2-26	Character Inspection	2-395
2-26-1	Settings Flow (Character Inspection)	2-395
2-26-2	Dictionary Parameters (Character Inspection)	2-396
2-26-3	Region Setting (Character Inspection)	2-397
2-26-4	Measurement Parameters (Character Inspection)	2-397
2-26-5	Output Parameters (Character Inspection)	2-399
2-26-6	Key Points for Test Measurement and Adjustment (Character Inspection)	2-403
2-26-7	Measurement Results for Which Output Is Possible (Character Inspection)	2-404
2-26-8	External Reference Tables (Character Inspection)	2-405
2-27	Date Verification	2-408
2-27-1	Settings Flow (Date Verification)	2-408
2-27-2	Verification Parameters (Date Verification)	2-409
2-27-3	Date Parameters (Date Verification)	2-410
2-27-4	Code Parameters (Date Verification)	2-413
2-27-5	Output parameter (Date Verification)	2-417
2-27-6	Key Points for Test Measurement and Adjustment (Date Verification)	2-418
2-27-7	Measurement Results for Which Output Is Possible (Date Verification)	2-418
2-27-8	External Reference Tables (Date Verification)	2-418
2-28	Model Dictionary	2-421
2-28-1	Settings Flow (Model Dictionary)	2-421
2-28-2	Model Registration (Model Dictionary)	2-422
2-28-3	Measurement Parameters (Model Dictionary)	2-425
2-28-4	Model Automatic Registration (Model Dictionary)	2-425
2-28-5	Key Points for Test Measurement and Adjustment (Model Dictionary)	2-427
2-28-6	Measurement Results for Which Output Is Possible (Model Dictionary)	2-427
2-28-7	External Reference Tables (Model Dictionary)	2-428
2-29	2D Code	2-429
2-29-1	Settings Flow (2D Code)	2-429
2-29-2	Region Setting (2D Code)	2-430
2-29-3	Measurement Parameters (2D Code)	2-430
2-29-4	Reference Settings (2D Code)	2-435
2-29-5	Vertices Reference Setting (2D Code)	2-437
2-29-6	Results Settings (2D Code)	2-439
2-29-7	Output Parameters (2D Code)	2-439
2-29-8	Output of Character String with Result Output (I/O) with EtherNet/IP	2-444
2-29-9	Output of Character String with Result Output (I/O) with EtherCAT	2-444
2-29-10	Output of Character String with Result Output (I/O) with PROFINET	2-445
2-29-11	Key Points for Test Measurement and Adjustment (2D Code)	2-445
2-29-12	Measurement Results for Which Output Is Possible (2D Code)	2-447
2-29-13	External Reference Tables (2D Code)	2-450
2-30	2D Code II	2-456
2-30-1	Settings Flow (2D Code II)	2-456
2-30-2	Region Setting (2D Code II)	2-457

2-30-3	Measurement Parameters (2D Code II)	2-457
2-30-4	Reference Settings (2D Code II)	2-460
2-30-5	Vertices Reference Setting (2D Code II)	2-462
2-30-6	Results Settings (2D Code II)	2-464
2-30-7	Output Parameters (2D Code II)	2-464
2-30-8	Key Points for Test Measurement and Adjustment (2D Code II)	2-466
2-30-9	Measurement Results for Which Output Is Possible (2D Code II)	2-468
2-30-10	External Reference Tables (2D Code II)	2-471
2-31	Barcode	2-477
2-31-1	Settings Flow (Barcode)	2-477
2-31-2	Region Setting (Barcode)	2-478
2-31-3	Measurement Parameters (Barcode)	2-478
2-31-4	Results Settings (Barcode)	2-482
2-31-5	Output Parameters (Barcode)	2-482
2-31-6	Key Points for Test Measurement and Adjustment (Barcode)	2-486
2-31-7	Measurement Results for Which Output Is Possible (Barcode)	2-487
2-31-8	External Reference Tables (Barcode)	2-489
2-32	OCR User Dictionary	2-492
2-32-1	Settings Flow (OCR User Dictionary)	2-492
2-32-2	Dictionary Reference (OCR User Dictionary)	2-493
2-32-3	Dictionary Operation (OCR User Dictionary)	2-496
2-32-4	Key Points for Test Measurement and Adjustment (OCR User Dictionary)	2-497
2-33	OCR	2-498
2-33-1	Settings Flow (OCR)	2-499
2-33-2	Region Setting (OCR)	2-501
2-33-3	Measurement Parameters (OCR)	2-502
2-33-4	Judgement Conditions (OCR)	2-512
2-33-5	Dictionary Settings (OCR)	2-519
2-33-6	Dictionary Registration (OCR)	2-522
2-33-7	Date Parameters (OCR)	2-523
2-33-8	Code Parameters (OCR)	2-527
2-33-9	Output Parameters (OCR)	2-530
2-33-10	Key Points for Test Measurement and Adjustment (OCR)	2-535
2-33-11	Measurement Results for Which Output is Possible (OCR)	2-537
2-33-12	External Reference Tables (OCR)	2-538
2-34	Circle Angle	2-546
2-34-1	Settings Flow (Circle Angle)	2-547
2-34-2	Region Setting (Circle Angle)	2-548
2-34-3	Output Parameters (Circle Angle)	2-550
2-34-4	Key Points for Test Measurement and Adjustment (Circle Angle)	2-551
2-34-5	Measurement Results for Which Output Is Possible (Circle Angle)	2-551
2-34-6	External Reference Tables (Circle Angle)	2-552
2-35	Glue Bead Inspection	2-554
2-35-1	Settings Flow (Glue Bead Inspection)	2-554
2-35-2	Color Specification (Glue Bead Inspection)	2-555
2-35-3	Binarization (Glue Bead Inspection)	2-557
2-35-4	Region Setting (Glue Bead Inspection)	2-558
2-35-5	Measurement Parameters (Glue Bead Inspection)	2-561
2-35-6	Output Parameters (Glue Bead Inspection)	2-563
2-35-7	Key Points for Test Measurement and Adjustment (Glue Bead Inspection)	2-564
2-35-8	Measurement Results for Which Output is Possible (Glue Bead Inspection)	2-565
2-35-9	External Reference Tables (Glue Bead Inspection)	2-566
2-36	AI Fine Matching	2-575
2-36-1	Settings Flow (AI Fine Matching)	2-577
2-36-2	Image preparations	2-578
2-36-3	Normal image learning	2-585
2-36-4	Setting optimization	2-593
2-36-5	Input Parameters (AI Fine Matching)	2-610
2-36-6	Output parameters (AI Fine Matching)	2-614
2-36-7	Key Points for Test Measurement and Adjustment (AI Fine Matching)	2-614
2-36-8	External reference data (AI Fine Matching)	2-618

Section 3 Compensate Image

3-1	Position Compensation	3-3
3-1-1	Region Settings (Position Compensation)	3-4
3-1-2	Scroll Method (Position Compensation).....	3-5
3-1-3	Key Points for Test Measurement and Adjustment (Position Compensation).....	3-6
3-1-4	Measurement Results for Which Output Is Possible (Position Compensation)	3-6
3-1-5	External Reference Tables (Position Compensation).....	3-7
3-2	Filtering	3-9
3-2-1	Filtering Parameters (Filtering).....	3-10
3-2-2	Region Settings (Filtering).....	3-12
3-2-3	External Reference Tables (Filtering).....	3-13
3-3	Background Suppression	3-14
3-3-1	Filter Settings (Background Suppression).....	3-15
3-3-2	Region Settings (Background Suppression)	3-16
3-3-3	Measurement Results for Which Output Is Possible (Background Suppression)	3-16
3-3-4	External Reference Tables (Background Suppression)	3-17
3-4	Brightness Correct Filter	3-19
3-4-1	Filter Settings (Brightness Correct Filter)	3-20
3-4-2	Region Settings (Brightness Correct Filter).....	3-21
3-4-3	External Reference Tables (Brightness Correct Filter).....	3-22
3-5	Color Gray Filter	3-24
3-5-1	Filter Settings (Color Gray Filter)	3-24
3-5-2	External Reference Tables (Color Gray Filter)	3-26
3-6	Extract Color Filter	3-28
3-6-1	Color Specification (Extract Color Filter)	3-28
3-6-2	Region Settings (Extract Color Filter).....	3-31
3-6-3	Output Image (Extract Color Filter)	3-31
3-6-4	Key Points for Test Measurement and Adjustment (Extract Color Filter)	3-31
3-6-5	Measurement Results for Which Output Is Possible (Extract Color Filter).....	3-31
3-6-6	External Reference Tables (Extract Color Filter).....	3-32
3-7	Anti Color Shading	3-35
3-7-1	Filter Setting (Anti Color Shading).....	3-35
3-7-2	Region Settings (Anti Color Shading)	3-37
3-7-3	Key Points for Test Measurement and Adjustment (Anti Color Shading).....	3-37
3-7-4	Measurement Results for Which Output Is Possible (Anti Color Shading)	3-38
3-7-5	External Reference Tables (Anti Color Shading).....	3-38
3-8	Stripes Removal Filter II	3-40
3-8-1	Filter Setting (Stripes Removal Filter II)	3-41
3-8-2	Region Settings (Stripes Removal Filter II).....	3-43
3-8-3	Key Points for Test Measurement and Adjustment (Stripes Removal Filter II)	3-43
3-8-4	External Reference Tables (Stripes Removal Filter II)	3-44
3-9	Polar Transformation	3-45
3-9-1	Region Settings (Polar Transformation)	3-45
3-9-2	Key Points for Test Measurement and Adjustment (Polar Transformation)	3-47
3-9-3	Measurement Results for Which Output Is Possible (Polar Transformation).....	3-47
3-9-4	External Reference Tables (Polar Transformation)	3-47
3-10	Trapezoidal Correction	3-49
3-10-1	Conversion Method (Trapezoidal Correction)	3-49
3-10-2	Region Settings (Trapezoidal Correction)	3-55
3-10-3	Key Points for Test Measurement and Adjustment (Trapezoidal Correction).....	3-55
3-10-4	Measurement Results for Which Output Is Possible (Trapezoidal Correction)	3-55
3-10-5	External Reference Tables (Trapezoidal Correction)	3-56
3-11	Machine Simulator	3-58
3-11-1	Settings Flow (Machine Simulator)	3-58
3-11-2	Machine Setting (Machine Simulator)	3-59
3-11-3	Actual Setting (Machine Simulator).....	3-60
3-11-4	Movement Setting (Machine Simulator).....	3-61

3-11-5	Key Points for Test Measurement and Adjustment (Machine Simulator)	3-62
3-11-6	Measurement Results for Which Output Is Possible (Machine Simulator)	3-63
3-11-7	External Reference Tables (Machine Simulator)	3-64
3-12	Image Subtraction	3-66
3-12-1	Settings Flow (Image Subtraction)	3-66
3-12-2	Operation Mode (Image Subtraction)	3-67
3-12-3	Model (Image Subtraction)	3-68
3-12-4	Disp. Image Sub. (Image Subtraction)	3-69
3-12-5	Color (Image Subtraction)	3-70
3-12-6	Key Points for Adjustment (Image Subtraction)	3-71
3-12-7	Measurement Results for Which Output Is Possible (Image Subtraction)	3-71
3-12-8	External Reference Tables (Image Subtraction)	3-72
3-13	Advanced Filter	3-73
3-13-1	Settings Flow (Advanced Filter)	3-74
3-13-2	Filtering Settings (Advanced Filter)	3-75
3-13-3	Region Settings (Advanced Filter)	3-118
3-13-4	Output Image Settings (Advanced Filter)	3-118
3-13-5	Key Points for Test Measurement and Adjustment (Advanced Filter)	3-119
3-13-6	Measurement Results for Which Output Is Possible (Advanced Filter)	3-121
3-13-7	External Reference Tables (Advanced Filter)	3-121
3-14	Panorama	3-137
3-14-1	Camera Arrangement (Panorama)	3-140
3-14-2	Image Combination (Panorama)	3-141
3-14-3	Key Points for Test Measurement and Adjustment (Panorama)	3-144
3-14-4	Measurement Results for Which Output Is Possible (Panorama)	3-145
3-14-5	External Reference Tables (Panorama)	3-145

Section 4 Support Inspection and Measurement

4-1	Unit Macro	4-6
4-2	Unit Calculation Macro	4-7
4-2-1	External Reference Tables (Unit Calculation Macro)	4-7
4-3	Calculation	4-8
4-3-1	Settings (Calculation)	4-9
4-3-2	Output parameter (Calculation)	4-11
4-3-3	Layout of Setting Expression Window (Calculation)	4-12
4-3-4	Expression Usage Examples (Calculation)	4-16
4-3-5	Key Points for Test Measurement and Adjustment (Calculation)	4-19
4-3-6	Measurement Results for Which Output Is Possible (Calculation)	4-20
4-3-7	External Reference Tables (Calculation)	4-20
4-4	Line Regression	4-22
4-4-1	Function Selection (Line Regression)	4-22
4-4-2	Line 0 (Line Regression)	4-23
4-4-3	Line 1 (Line Regression)	4-24
4-4-4	Point (Line Regression)	4-24
4-4-5	Key Points for Test Measurement and Adjustment (Line Regression)	4-25
4-4-6	Measurement Results for Which Output Is Possible (Line Regression)	4-25
4-4-7	External Reference Tables (Line Regression)	4-26
4-5	Circle Regression	4-28
4-5-1	Parameter Settings (Circle Regression)	4-28
4-5-2	Key Points for Test Measurement and Adjustment (Circle Regression)	4-29
4-5-3	Measurement Results for Which Output Is Possible (Circle Regression)	4-29
4-5-4	External Reference Tables (Circle Regression)	4-30
4-6	Precise Calibration	4-32
4-6-1	Calibration (Precise Calibration)	4-33
4-6-2	Height Adjustment (Precise Calibration)	4-39
4-6-3	Image Correction (Precise Calibration)	4-40
4-6-4	Measurement Results for Which Output Is Possible (Precise Calibration)	4-40
4-6-5	External Reference Tables (Precise Calibration)	4-41

4-7	User Data	4-42
4-7-1	Settings Flow (User Data)	4-42
4-7-2	Settings (User Data)	4-43
4-7-3	Key Points for Test Measurement and Adjustment (User Data)	4-44
4-7-4	Measurement Results For Which Output Is Possible (User Data)	4-44
4-7-5	External Reference Tables (Set User Data)	4-45
4-8	Set Unit Data	4-46
4-8-1	Parameter Settings (Set Unit Data)	4-46
4-8-2	Key Points for Test Measurement and Adjustment (Set Unit Data)	4-48
4-8-3	Measurement Results for Which Output Is Possible (Set Unit Data)	4-48
4-8-4	External Reference Tables (Set Unit Data)	4-49
4-9	Get Unit Data	4-50
4-9-1	Parameter Settings (Get Unit Data)	4-50
4-9-2	Measurement Results for Which Output Is Possible (Get Unit Data)	4-51
4-9-3	External Reference Tables (Get Unit Data)	4-52
4-10	Set Unit Figure	4-53
4-10-1	Parameter Settings (Set Unit Figure)	4-53
4-10-2	Key Points for Test Measurement and Adjustment (Set Unit Figure)	4-55
4-10-3	Measurement Results for Which Output Is Possible (Set Unit Figure)	4-55
4-10-4	External Reference Tables (Set Unit Figure)	4-56
4-11	Get Unit Figure	4-60
4-11-1	Parameter Settings (Get Unit Figure)	4-60
4-11-2	Key Points for Test Measurement and Adjustment (Get Unit Figure)	4-60
4-11-3	Measurement Results for Which Output Is Possible (Get Unit Figure)	4-61
4-11-4	External Reference Tables (Get Unit Figure)	4-63
4-12	Trend Monitor	4-67
4-12-1	Measurement Values (Trend Monitor)	4-68
4-12-2	Display Range (Trend Monitor)	4-68
4-12-3	Judgment (Trend Monitor)	4-71
4-12-4	Measurement History Display (Trend Monitor)	4-72
4-12-5	Data Save (Trend Monitor)	4-74
4-12-6	Output parameter (Trend Monitor)	4-76
4-12-7	Key Points for Test Measurement and Adjustment (Trend Monitor)	4-76
4-12-8	Measurement Results for Which Output Is Possible (Trend Monitor)	4-77
4-12-9	External Reference Tables (Trend Monitor)	4-78
4-13	Image Logging	4-80
4-13-1	Logging Conditions (Image Logging)	4-80
4-13-2	Save Destination (Image Logging)	4-81
4-13-3	Key Points for Test Measurement and Adjustment (Image Logging)	4-83
4-13-4	Measurement Results for Which Output Is Possible (Image Logging)	4-83
4-13-5	External Reference Tables (Image Logging)	4-84
4-14	Image Conversion Logging	4-85
4-14-1	Save Conditions (Image Conversion Logging)	4-85
4-14-2	Destination (Image Conversion Logging)	4-87
4-14-3	Area Setting (Image Conversion Logging)	4-88
4-14-4	Key Points for Test Measurement and Adjustment (Image Conversion Logging)	4-88
4-14-5	Measurement Results for Which Output Is Possible (Image Conversion Logging)	4-88
4-14-6	External Reference Tables (Image Conversion Logging)	4-89
4-15	Data Logging	4-91
4-15-1	Settings (Data Logging)	4-92
4-15-2	Output Format (Data Logging)	4-92
4-15-3	Additional Explanation (Data Logging)	4-95
4-15-4	Measurement Results for Which Output Is Possible (Data Logging)	4-96
4-15-5	External Reference Tables (Data Logging)	4-96
4-16	Elapsed Time	4-98
4-16-1	Measurement Results for Which Output Is Possible (Elapsed Time)	4-99
4-16-2	External Reference Tables (Elapsed Time)	4-99
4-17	Wait	4-100
4-17-1	Settings (Wait)	4-100

4-17-2	External Reference Tables (Wait).....	4-100
4-18	Focus	4-101
4-18-1	Measurement Parameters (Focus)	4-101
4-18-2	Region Setting (Focus)	4-102
4-18-3	Output parameter (Focus).....	4-102
4-18-4	Key Points for Test Measurement and Adjustment (Focus)	4-103
4-18-5	External Reference Tables (Focus).....	4-103
4-19	Iris.....	4-106
4-19-1	Measurement Parameters (Iris)	4-106
4-19-2	Region Setting (Iris)	4-108
4-19-3	Output parameter (Iris).....	4-108
4-19-4	Key Points for Test Measurement and Adjustment (Iris)	4-108
4-19-5	External Reference Tables (Iris).....	4-109
4-20	Parallelize	4-112
4-21	Parallelize Task	4-113
4-22	Statistics	4-114
4-22-1	Settings Flow (Statistics).....	4-114
4-22-2	Statistical Parameters (Statistics)	4-114
4-22-3	Data Setting (Statistics).....	4-115
4-22-4	Data Display (Statistics).....	4-116
4-22-5	Output Parameters (Statistics)	4-118
4-22-6	Key Points for Test Measurement and Adjustment (Statistics)	4-118
4-22-7	Measurement Results for Which Output Is Possible (Statistics)	4-119
4-22-8	External Reference Tables (Statistics)	4-120
4-23	Calibration Data Reference	4-122
4-23-1	Settings Flow (Calibration Data Reference).....	4-122
4-23-2	Calibration (Calibration Data Reference)	4-123
4-23-3	Distortion Correction (Calibration Data Reference).....	4-124
4-23-4	Key Points for Test Measurement and Adjustment (Calibration Data Reference)	4-125
4-23-5	Measurement Results for Which Output Is Possible (Calibration Data Reference)	4-126
4-23-6	External Reference Tables (Calibration Data Reference)	4-126
4-24	Position Data Calculation.....	4-128
4-24-1	Settings Flow (Position Data Calculation)	4-128
4-24-2	Calculation Setting (Position Data Calculation).....	4-129
4-24-3	Output parameter (Position Data Calculation)	4-133
4-24-4	Key Points for Test Measurement and Adjustment (Position Data Calculation).....	4-133
4-24-5	Measurement Results for Which Output Is Possible (Position Data Calculation)	4-133
4-24-6	External Reference Tables (Position Data Calculation)	4-134
4-25	Robot Data.....	4-137
4-25-1	Data Setting (Robot Data).....	4-137
4-25-2	Measurement Results for Which Output Is Possible (Robot Data)	4-141
4-25-3	External Reference Tables (Robot Data)	4-141
4-26	Vision Master Calibration.....	4-143
4-26-1	Settings Flow (Vision Master Calibration)	4-144
4-26-2	Machine Setting (Vision Master Calibration)	4-144
4-26-3	Calibration (Vision Master Calibration).....	4-145
4-26-4	Sampling Setting (Vision Master Calibration).....	4-149
4-26-5	Calibration Result (Vision Master Calibration).....	4-162
4-26-6	Key Points for Test Measurement and Adjustment (Vision Master Calibration).....	4-168
4-26-7	Measurement Results for Which Output Is Possible (Vision Master Calibration).....	4-170
4-26-8	External Reference Tables (Vision Master Calibration).....	4-171
4-27	PLC Master Calibration	4-176
4-27-1	Settings Flow (PLC Master Calibration)	4-177
4-27-2	Machine Setting (PLC Master Calibration).....	4-177
4-27-3	Calibration (PLC Master Calibration)	4-178
4-27-4	Sampling Setting (PLC Master Calibration)	4-180
4-27-5	Calibration Result (PLC Master Calibration)	4-181
4-27-6	Key Points for Test Measurement and Adjustment (PLC Master Calibration).....	4-182
4-27-7	Measurement Results for Which Output Is Possible (PLC Master Calibration)	4-183

4-27-8	External Reference Tables (PLC Master Calibration)	4-184
4-28	Transfer Position Data	4-187
4-28-1	Settings Flow (Transfer Position Data)	4-187
4-28-2	Machine Setting (Transfer Position Data)	4-188
4-28-3	Transfer Parameter (Transfer Position Data)	4-189
4-28-4	Output parameter (Transfer Position Data)	4-194
4-28-5	Key Points for Test Measurement and Adjustment (Transfer Position Data)	4-194
4-28-6	Measurement Results for Which Output Is Possible (Transfer Position Data)	4-195
4-28-7	External Reference Tables (Transfer Position Data)	4-195
4-29	Calc Axis Move	4-197
4-29-1	Settings Flow (Calc Axis Move)	4-197
4-29-2	Machine Setting (Calc Axis Move)	4-198
4-29-3	Calc. Parameter (Calc Axis Move)	4-199
4-29-4	Judgment Condition (Calc Axis Move)	4-202
4-29-5	Output Parameter (Calc Axis Move)	4-204
4-29-6	Key Points for Test Measurement and Adjustment (Calc Axis Move)	4-205
4-29-7	Measurement Results for Which Output Is Possible (Calc Axis Move)	4-207
4-29-8	External Reference Tables (Calc Axis Move)	4-209
4-30	Calc Axis Move by Multipoint	4-212
4-30-1	Settings Flow (Calc Axis Move by Multipoint)	4-212
4-30-2	Machine Setting (Calc Axis Move by Multipoint)	4-213
4-30-3	Calc. Parameter (Calc Axis Move by Multipoint)	4-214
4-30-4	Judgement Condition (Calc Axis Move by Multipoint)	4-219
4-30-5	Output Parameter (Calc Axis Move by Multipoint)	4-222
4-30-6	Key Points for Test Measurement and Adjustment (Calc Axis Move by Multipoint)	4-222
4-30-7	Measurement Results for Which Output Is Possible (Calc Axis Move by Multipoint)	4-224
4-30-8	External Reference Tables (Calc Axis Move by Multipoint)	4-225
4-31	Detection Point	4-228
4-31-1	Parameter Setting (Detection Point)	4-229
4-31-2	Measurement Results for Which Output Is Possible (Detection Point)	4-229
4-31-3	External Reference Tables (Detection Point)	4-230
4-32	Manual Position Setting	4-231
4-32-1	Settings Flow (Manual Position Setting)	4-234
4-32-2	Data Setting (Manual Position Setting)	4-236
4-32-3	Position Setting (Manual Position Setting)	4-242
4-32-4	Measurement Results for Which Output Is Possible (Manual Position Setting)	4-247
4-32-5	External Reference Tables (Manual Position Setting)	4-247
4-33	Camera Calibration	4-249
4-33-1	Settings Flow (Camera Calibration)	4-249
4-33-2	Specify Point (Camera Calibration)	4-250
4-33-3	Value Appointment (Camera Calibration)	4-251
4-33-4	Sampling (Camera Calibration)	4-253
4-33-5	Dimension Measure (Camera Calibration)	4-255
4-33-6	Data Display (Camera Calibration)	4-258
4-33-7	Measurement Results for Which Output Is Possible (Camera Calibration)	4-261
4-33-8	External Reference Tables (Camera Calibration)	4-261
4-34	Data Save	4-265
4-34-1	Setting (Data Save)	4-265
4-34-2	Key Points for Test Measurement and Adjustment (Data Save)	4-266
4-34-3	Measurement Results for Which Output Is Possible (Data Save)	4-267
4-34-4	External Reference Tables (Data Save)	4-267
4-35	Stage Data	4-268
4-35-1	Data Setting (Stage Data)	4-268
4-35-2	Measurement Results for Which Output Is Possible (Stage Data)	4-290
4-35-3	External Reference Tables (Stage Data)	4-290
4-36	Conveyor Calibration	4-293
4-37	Scene	4-294
4-37-1	Scene Setting (Scene)	4-295
4-37-2	External Reference Tables (Scene)	4-301

4-38	System Information	4-302
4-38-1	Usage	4-302
4-38-2	Available System Information (System information).....	4-302
4-38-3	External Reference Tables (System information).....	4-304

Section 5 Branch

5-1	Conditional Branch.....	5-3
5-1-1	List of Conditional Branch Items	5-4
5-1-2	Conditional Branch.....	5-4
5-1-3	Conditional Branch Settings Examples	5-5
5-1-4	Timeout (Conditional Branch).....	5-7
5-1-5	Measurement Results for Which Output Is Possible (Conditional Branch)	5-7
5-1-6	External Reference Tables (Conditional Branch)	5-8
5-2	End	5-9
5-3	DI Branch	5-11
5-3-1	Settings (DI Branch).....	5-11
5-3-2	Timeout (DI Branch).....	5-12
5-3-3	Measurement Results for Which Output Is Possible (DI Branch)	5-13
5-3-4	External Reference Tables (DI Branch).....	5-14
5-4	Control Flow Normal.....	5-16
5-4-1	Settings Flow (Control Flow Normal)	5-17
5-4-2	Settings (Control Flow Normal)	5-17
5-4-3	Output Parameters (Control Flow Normal).....	5-18
5-4-4	Key Points for Test Measurement and Adjustment (Control Flow Normal)	5-19
5-4-5	Measurement Results for Which Output Is Possible (Control Flow Normal).....	5-19
5-4-6	External Reference Tables (Control Flow Normal).....	5-19
5-5	Control Flow PLC Link	5-21
5-5-1	Settings Flow (Control Flow PLC Link)	5-22
5-5-2	Settings (Control Flow PLC Link)	5-22
5-5-3	Output Parameters (Control Flow PLC Link).....	5-23
5-5-4	Key Points for Test Measurement and Adjustment (Control Flow PLC Link)	5-24
5-5-5	Measurement Results for Which Output Is Possible (Control Flow PLC Link).....	5-24
5-5-6	Timing Chart (Control Flow PLC Link).....	5-24
5-5-7	External Reference Tables (Control Flow PLC Link).....	5-26
5-6	Control Flow Parallel	5-27
5-6-1	Settings Flow (Control Flow Parallel)	5-28
5-6-2	Settings (Control Flow Parallel).....	5-28
5-6-3	Output Parameters (Control Flow Parallel)	5-29
5-6-4	Key Points for Test Measurement and Adjustment (Control Flow Parallel).....	5-30
5-6-5	Measurement Results for Which Output Is Possible (Control Flow Parallel)	5-30
5-6-6	External Reference Tables (Control Flow Parallel)	5-31
5-7	Control Flow Fieldbus	5-32
5-7-1	Settings Flow (Control Flow Fieldbus)	5-33
5-7-2	Settings (Control Flow Fieldbus)	5-33
5-7-3	Output Parameters (Control Flow Fieldbus).....	5-34
5-7-4	Key Points for Test Measurement and Adjustment (Control Flow Fieldbus)	5-35
5-7-5	Measurement Results for Which Output Is Possible (Control Flow Fieldbus).....	5-35
5-7-6	Timing Chart (Control Flow Fieldbus).....	5-35
5-7-7	External Reference Tables (Control Flow Fieldbus).....	5-38
5-8	Selective Branch.....	5-39
5-8-1	Selective Branch (Selective Branch).....	5-40
5-8-2	Output Parameters (Selective Branch)	5-41
5-8-3	Timeout (Selective Branch).....	5-41
5-8-4	Key Points for Test Measurement and Adjustment (Selective Branch).....	5-42
5-8-5	Measurement Results for Which Output Is Possible (Selective Branch)	5-43
5-8-6	External Reference Tables (Selective Branch).....	5-44
5-9	Conditional Execution (If)	5-45

5-9-1	Conditional Execution Settings (Conditional Execution (If))	5-45
5-9-2	External Reference Tables (Conditional Execution (If))	5-49
5-10	Conditional Execution (Else)	5-50
5-10-1	Conditional Execution Settings (Conditional Execution (Else))	5-50
5-10-2	External Reference Tables (Conditional Execution (Else))	5-54
5-11	Loop	5-55
5-11-1	Loop detail settings (Loop)	5-56
5-11-2	External Reference Tables (Loop)	5-58
5-12	Loop Interrupt	5-59
5-12-1	Loop Interrupt Settings (Loop Interrupt)	5-60
5-12-2	External Reference Tables (Loop suspension)	5-60
5-13	Select Execution (Select)	5-61
5-13-1	Select Execution Setting (Select Execution (Select))	5-62
5-13-2	External Reference Tables (Select execution (Select))	5-64
5-14	Select Execution (Case)	5-65
5-14-1	Select Execution Setting (Select Execution (Case))	5-65
5-14-2	External Reference Tables (Select execution (Case))	5-68

Section 6 Output Result

6-1	Result Output (I/O)	6-2
6-1-1	External Reference Tables (Result output (I / O))	6-2
6-2	Result Output (Message)	6-3
6-2-1	External Reference Tables (Result output (Message))	6-5
6-3	Result Output (Result Output (Parallel I/O))	6-6
6-3-1	External Reference Tables (Result Output (Parallel I/O))	6-6
6-4	Data Output	6-7
6-4-1	External Reference Tables (Data Output)	6-7
6-5	Parallel Data Output	6-9
6-5-1	External Reference Tables (Parallel Data Output)	6-9
6-6	Parallel Judgement Output	6-10
6-6-1	External Reference Tables (Parallel Judgement Output)	6-10
6-7	Fieldbus Data Output	6-12
6-7-1	External Reference Tables (Fieldbus Data Output)	6-12

Section 7 Display Result

7-1	Result Display	7-2
7-1-1	Result Display	7-3
7-1-2	External Reference Tables (Result Display)	7-7
7-2	Display Image File	7-11
7-2-1	Select Image (Display Image File)	7-11
7-2-2	Key Points for Test Measurement and Adjustment (Display Image File)	7-12
7-2-3	External Reference Tables (Display Image File)	7-12
7-3	Display Last NG Image	7-14
7-3-1	NG Error Judgment (Display Last NG Image)	7-14
7-3-2	Image Saving (Display Last NG Image)	7-16
7-3-3	Data Saving (Display Last NG Image)	7-16
7-3-4	Output parameters (Display Last NG Image)	7-17
7-3-5	Key Points for Test Measurement and Adjustment (Display Last NG Image)	7-17
7-3-6	Measurement Results for Which Output Is Possible (Display Last NG Image)	7-18
7-3-7	External Reference Tables (Display Last NG Image)	7-19
7-4	Conveyor Panorama Display	7-20

7-5	Display Image Hold	7-21
7-5-1	Display Image Retention Settings (Display Image Hold)	7-21
7-5-2	External Reference Tables (Display image hold)	7-22

Index

Terms and Conditions Agreement

Warranty, Limitations of Liability

Warranties

● Exclusive Warranty

Omron's exclusive warranty is that the Products will be free from defects in materials and workmanship for a period of twelve months from the date of sale by Omron (or such other period expressed in writing by Omron). Omron disclaims all other warranties, express or implied.

● Limitations

OMRON MAKES NO WARRANTY OR REPRESENTATION, EXPRESS OR IMPLIED, ABOUT NON-INFRINGEMENT, MERCHANTABILITY OR FITNESS FOR A PARTICULAR PURPOSE OF THE PRODUCTS. BUYER ACKNOWLEDGES THAT IT ALONE HAS DETERMINED THAT THE PRODUCTS WILL SUITABLY MEET THE REQUIREMENTS OF THEIR INTENDED USE.

Omron further disclaims all warranties and responsibility of any type for claims or expenses based on infringement by the Products or otherwise of any intellectual property right.

● Buyer Remedy

Omron's sole obligation hereunder shall be, at Omron's election, to (i) replace (in the form originally shipped with Buyer responsible for labor charges for removal or replacement thereof) the non-complying Product, (ii) repair the non-complying Product, or (iii) repay or credit Buyer an amount equal to the purchase price of the non-complying Product; provided that in no event shall Omron be responsible for warranty, repair, indemnity or any other claims or expenses regarding the Products unless Omron's analysis confirms that the Products were properly handled, stored, installed and maintained and not subject to contamination, abuse, misuse or inappropriate modification. Return of any Products by Buyer must be approved in writing by Omron before shipment. Omron Companies shall not be liable for the suitability or unsuitability or the results from the use of Products in combination with any electrical or electronic components, circuits, system assemblies or any other materials or substances or environments. Any advice, recommendations or information given orally or in writing, are not to be construed as an amendment or addition to the above warranty.

See <http://www.omron.com/global/> or contact your Omron representative for published information.

Limitation on Liability; Etc

OMRON COMPANIES SHALL NOT BE LIABLE FOR SPECIAL, INDIRECT, INCIDENTAL, OR CONSEQUENTIAL DAMAGES, LOSS OF PROFITS OR PRODUCTION OR COMMERCIAL LOSS IN

ANY WAY CONNECTED WITH THE PRODUCTS, WHETHER SUCH CLAIM IS BASED IN CONTRACT, WARRANTY, NEGLIGENCE OR STRICT LIABILITY.

Further, in no event shall liability of Omron Companies exceed the individual price of the Product on which liability is asserted.

Application Considerations

Suitability of Use

Omron Companies shall not be responsible for conformity with any standards, codes or regulations which apply to the combination of the Product in the Buyer's application or use of the Product. At Buyer's request, Omron will provide applicable third party certification documents identifying ratings and limitations of use which apply to the Product. This information by itself is not sufficient for a complete determination of the suitability of the Product in combination with the end product, machine, system, or other application or use. Buyer shall be solely responsible for determining appropriateness of the particular Product with respect to Buyer's application, product or system. Buyer shall take application responsibility in all cases.

NEVER USE THE PRODUCT FOR AN APPLICATION INVOLVING SERIOUS RISK TO LIFE OR PROPERTY OR IN LARGE QUANTITIES WITHOUT ENSURING THAT THE SYSTEM AS A WHOLE HAS BEEN DESIGNED TO ADDRESS THE RISKS, AND THAT THE OMRON PRODUCT(S) IS PROPERLY RATED AND INSTALLED FOR THE INTENDED USE WITHIN THE OVERALL EQUIPMENT OR SYSTEM.

Programmable Products

Omron Companies shall not be responsible for the user's programming of a programmable Product, or any consequence thereof.

Disclaimers

Performance Data

Data presented in Omron Company websites, catalogs and other materials is provided as a guide for the user in determining suitability and does not constitute a warranty. It may represent the result of Omron's test conditions, and the user must correlate it to actual application requirements. Actual performance is subject to the Omron's Warranty and Limitations of Liability.

Change in Specifications

Product specifications and accessories may be changed at any time based on improvements and other reasons. It is our practice to change part numbers when published ratings or features are changed, or when significant construction changes are made. However, some specifications of the

Product may be changed without any notice. When in doubt, special part numbers may be assigned to fix or establish key specifications for your application. Please consult with your Omron's representative at any time to confirm actual specifications of purchased Product.

Errors and Omissions

Information presented by Omron Companies has been checked and is believed to be accurate; however, no responsibility is assumed for clerical, typographical or proofreading errors or omissions.

Safety Precautions

For details on Safety Precautions, refer to *Safety Precautions* in the *Vision System FH/FHV Series User's Manual (Cat. No. Z365)*.

Precautions for Safe Use

For details on Precautions for Safe Use, refer to *Precautions for Safe Use* in the *Vision System FH/FHV Series User's Manual (Cat. No. Z365)*.

Precautions for Correct Use

For details on Precautions for Correct Use, refer to *Precautions for Correct Use* in the *Vision System FH/FHV Series User's Manual (Cat. No. Z365)*.

Regulations and Standards

For details on Regulations and Standards, refer to *Regulations and Standards* in the *Vision System FH/FHV Series User's Manual (Cat. No. Z365)*.

Related Manuals

The followings are the manuals related to this manual. Use these manuals for reference.

Name of Manual	Cat. No.	Model	Purpose	Contents
Vision System FH Instruction Sheet	3615791-1	FH-2□□□ FH-2□□□-□□ FH-5□□□ FH-5□□□-□□	To confirm the safety and usage precautions of the Vision System FH series Sensor Controller.	Describes the definitions of basic terms, meaning of signal words, and precautions for correct use of FH series in the manual.
Vision System FH-L Instruction Sheet	3615792-0	FH-L□□□ FH-L□□□-□□	To confirm the safety and usage precautions of the Vision System FH-Lite series Sensor Controller.	Describes the definitions of basic terms, meaning of signal words, and precautions for correct use of FH-L series in the manual.
Vision System FZ5 Instruction Sheet	9524422-4	FZ5-6□□ FZ5-6□□-□□ FZ5-11□□ FZ5-11□□-□□	To confirm the setup procedures, safety and usage precautions of the Vision System FZ5-600, FZ5-1100 series Sensor Controller, including I/O setup and wiring.	Describes the definitions of basic terms, meaning of signal words, and precautions for correct use of FZ5-600, FZ5-1100 series in the manual.
Vision System FZ5 Instruction Sheet	9308317-7	FZ5-8□□ FZ5-8□□-□□ FZ5-12□□ FZ5-12□□-□□	To confirm the setup procedures, safety and usage precautions of the Vision System FZ5-800, FZ5-1200 series Sensor Controller, including I/O setup and wiring.	Describes the definitions of basic terms, meaning of signal words, and precautions for correct use of FZ5-800, FZ5-1200 series in the manual.
Vision System FZ5-L Instruction Sheet	9910002-2	FZ5-L35□ FZ5-L35□-□□	To confirm the setup procedures, safety and usage precautions of the Vision System FZ5-L Series Sensor Controller, including I/O setup and wiring.	Describes the definitions of basic terms, meaning of signal words, and precautions for correct use of FZ5-L series in the manual.
Smart Camera FHV Instruction Sheet	3615629-0	FHV7□-□□□□□-□□□-□ □	To confirm the safety and usage precautions of the Smart Camera FHV7 series.	Describes the definitions of basic terms, the meaning of signal words, and precautions for correct use of FHV7 series in the manual.
Smart Camera Lighting Module FHV-LTM Instruction Sheet	3129276-4	FHV-LTM□□	To confirm the safety and usage precautions of the Smart camera lighting module FHV-LTM.	Describes the definitions of basic terms, the meaning of signal words, and precautions for correct use of the lighting module FHV-LTM in the manual.
Smart Camera Lens Module FHV-LEM-S Instruction Sheet	3128622-5	FHV-LEM-S□□	To confirm the safety and usage precautions of the Smart camera lens module FHV-LEM-S.	Describes the definitions of basic terms, the meaning of signal words, and precautions for correct use of the lens module FHV-LEM-S.

Name of Manual	Cat. No..	Model	Purpose	Contents
Smart Camera High-Speed Lens Module FHV-LEM-H Instruction Sheet	3129408-2	FHV-LEM-H□□	To confirm the safety and usage precautions of the Smart camera high-speed lens module FHV-LEM-H.	Describes the definitions of basic terms, the meaning of signal words, and precautions for correct use of the high-speed lens module FHV-LEM-H.
FHV Series Smart Camera Setup Manual	Z408	FHV7□-□□□□□-C FHV7□-□□□□□-S□□ FHV7□-□□□□□-S□□-□ □ FHV7□-□□□□□-H□□ FHV7□-□□□□□-H□□-□ □	When User want to know about the hardware specifications or to setup the Smart camera FHV series.	Describes FHV series specifications, dimensions, part names, I/O information, installation information, and wiring information.
Vision System FH/FHV Series User's Manual	Z365	FH-2□□□ FH-2□□□-□□ FH-5□□□	When User want to know about the FH/FHV series.	Describes the soft functions, setup, and operations to use FH/FHV series.
Vision System FH/FHV series Processing Item Function Reference Manual	Z341	FH-5□□□-□□ FH-L□□□ FH-L□□□-□□ FHV7□-□□□□□-C FHV7□-□□□□□-S□□ FHV7□-□□□□□-S□□-□ □	When User confirm the details of each processing items at the create the measurement flow or operate it.	Describes the software functions, settings, and operations for using FH/FHV series.
Vision System FH/FHV Series User's manual for Communications Settings	Z342	FHV7□-□□□□□-H□□ FHV7□-□□□□□-H□□-□ □	When User confirm the setting of communication functions.	Describes the functions, settings, and communications methods for communication between FH/FHV series and PLCs. The following communications protocol are described. Parallel, PLC Link, EtherNet/IP, EtherCAT, and Non-procedure.
Vision System FH series Hardware Setup Manual	Z366	FH-2□□□ FH-2□□□-□□ FH-5□□□ FH-5□□□-□□ FH-L□□□ FH-L□□□-□□	When User want to know about the Hardware specifications or to setup the Sensor Controller of the Vision System FH series.	Describes FH series specifications, dimensions, part names, I/O information, installation information, and wiring information.
Vision System FH series Macro Customize Functions Programming Manual	Z367		When User operate or programming using Macro Customize functions.	Describes the functions, settings, and operations for using Macro Customize function of the FH series.
Vision System FH/FHV Series Operation Manual for Sysmac Studio	Z343	FH-2□□□ FH-2□□□-□□ FH-5□□□ FH-5□□□-□□ FHV7□-□□□□□-C FHV7□-□□□□□-S□□ FHV7□-□□□□□-S□□-□ □ FHV7□-□□□□□-H□□ FHV7□-□□□□□-H□□-□ □	When User connect to NJ/NX series via EtherCAT communication.	Describes the operating procedures for setting up and operating FH/FHV series Vision Sensors from the Sysmac Studio FH/FHV Tools.

Revision History

A manual revision code appears as a suffix to the catalog number on the front and back covers of the manual.

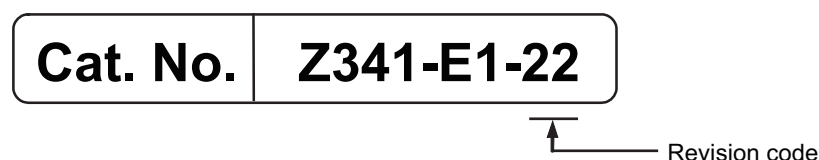

Rev. Code	Rev. Date	Revision Contents	Software Version
01	Jul. 2013	Original production	Ver.5.0
02	Aug. 2013	Additions for lighting controllers.	Ver.5.1
03	Aug. 2013	Additions for software version upgrade.	Ver.5.1
04	Sep. 2013	Additions for software version upgrade.	Ver.5.12
05	Jan. 2014	Additions for software version upgrade.	Ver.5.2
06	Jun. 2014	Additions for software version upgrade.	Ver.5.3
07	Oct. 2015	Additions for software version upgrade.	Ver.5.5
08	Apr. 2016	Additions for software version upgrade and description of FH-L series.	Ver.5.6
09	Mar.2017	Additions for software version upgrade.	Ver.5.71
10	Mar. 2017	Corrected mistakes.	Ver.5.71
11	Jun. 2017	Additions for software version upgrade.	Ver.5.72
12	Jul. 2018	Additions for software version upgrade.	Ver.6.1
13	Nov. 2018	Additions for software version upgrade.	Ver.6.2
14	Jul. 2019	Additions for software version upgrade.	Ver.6.3
15	Nov. 2019	Corrected mistakes.	Ver.6.3
16	Jun. 2020	Additions for software version upgrade.	Ver.6.4
17	Nov. 2020	Corrected mistakes.	Ver.6.4
18	Jun. 2021	Additions for FHV series Ver.6.4	Ver.6.4
19	Jan. 2022	Corrected mistakes.	Ver.6.4
20	May 2022	Deleted the product information of FH-1000/ FH-3000 series. Additions for software version upgrade. Corrected mistakes.	Ver.6.5
21	Dec. 2022	Revisions for update Related Manuals and AI Fine Matching. Corrected mistakes.	Ver.6.5
22	Mar. 2023	Added FH-SCX01, FH-SMX01, FH-SCX03, and FH-SMX03.	Ver.6.5

Input Image

This chapter describes how to load images from cameras.

1-1	Camera Image Input	1-3
1-1-1	Settings Flow (Camera Image Input).....	1-4
1-1-2	Select Camera (Camera Image Input).....	1-5
1-1-3	Camera Settings (Camera Image Input).....	1-6
1-1-4	Screen Adjustment Settings (Camera Image Input).....	1-11
1-1-5	White Balance (Camera Image Input).....	1-19
1-1-6	Calibration (Camera Image Input).....	1-21
1-1-7	Additional Explanation (Camera Image Input).....	1-26
1-1-8	External Reference Tables (Camera Image Input).....	1-27
1-2	Camera Image Input FH	1-28
1-2-1	Settings Flow (Camera Image Input FH).....	1-29
1-2-2	Select Camera (Camera Image Input FH).....	1-30
1-2-3	Camera Settings (Camera Image Input FH).....	1-31
1-2-4	Assigning Multiple Electronic Flashes to a Camera.....	1-40
1-2-5	Screen Adjustment Settings (Camera Image Input FH).....	1-41
1-2-6	White Balance (Camera Image Input FH).....	1-56
1-2-7	Calibration (Camera Image Input FH).....	1-58
1-2-8	External Reference Tables (Camera Image Input FH).....	1-64
1-3	Camera Image Input FHV	1-66
1-3-1	Settings Flow (Camera Image Input FHV).....	1-67
1-3-2	Camera Selection (Camera Image Input FHV).....	1-68
1-3-3	Camera Settings (Camera Image Input FHV).....	1-68
1-3-4	Screen Adjustment Settings (Camera Image Input FHV).....	1-75
1-3-5	White Balance (Camera Image Input FHV).....	1-82
1-3-6	Calibration (Camera Image Input FHV).....	1-83
1-3-7	Lens Adjustment (Camera Image Input FHV).....	1-89
1-3-8	External Reference Tables (Camera Image Input FHV).....	1-91
1-4	Camera Image Input HDR (using FH Controller)	1-93
1-4-1	Settings Flow (Camera Image Input HDR (using FH Controller)).....	1-94
1-4-2	Camera Settings (Camera Image Input HDR (using FH Controller)).....	1-95
1-4-3	HDR Settings (Camera Image Input HDR (using FH Controller)).....	1-100
1-4-4	Bright Adjust Setting (Camera Image Input HDR (using FH Controller)).....	1-101
1-4-5	Camera Model (Camera Image Input HDR (using FH Controller)).....	1-102
1-4-6	External Reference Tables (Camera Image Input HDR (using FH Controller)).....	1-103
1-5	Camera Image Input HDR (using FHV Controller)	1-105
1-5-1	Settings Flow (Camera Image Input HDR (using FHV Controller)).....	1-106
1-5-2	Camera Settings (Camera Image Input HDR (using FHV Controller)).....	1-107

1-5-3	HDR Settings (Camera Image Input HDR (using FHV Controller))	1-110
1-5-4	Bright Adjust Setting (Camera Image Input HDR (using FHV Controller)) ..	1-112
1-5-5	Lens Adjustment (Camera Image Input HDR (using FHV Controller))	1-113
1-5-6	External Reference Tables (Camera Image Input HDR (using FHV Controller))	1-114
1-6	Camera Image Input HDR Lite.....	1-116
1-6-1	Settings Flow (Camera Image Input HDR Lite)	1-117
1-6-2	Camera Settings (Camera Image Input HDR Lite)	1-118
1-6-3	HDR Settings (Camera Image Input HDR Lite)	1-118
1-6-4	Screen Adjust (Camera Image Input HDR Lite).....	1-119
1-6-5	External Reference Tables (Camera Image Input HDR Lite).....	1-120
1-7	Photometric Stereo Image Input (using FH Controller)	1-122
1-7-1	Settings Flow (Photometric Stereo Image Input (using FH Controller)).....	1-124
1-7-2	Image Input Settings (Photometric Stereo Image Input (using FH Controller))	1-125
1-7-3	Screen Adjust (Photometric Stereo Image Input (using FH Controller))....	1-133
1-7-4	Filter Setting (Photometric Stereo Image Input (using FH Controller))	1-138
1-7-5	Output Image (Photometric Stereo Image Input (using FH Controller))	1-141
1-7-6	White Balance (Photometric Stereo Image Input (using FH Controller))	1-142
1-7-7	Calibration (Photometric Stereo Image Input (using FH Controller))	1-142
1-7-8	Camera Model (Photometric Stereo Image Input (using FH Controller))....	1-142
1-7-9	External Reference Tables (Photometric Stereo Image Input (using FH Controller)).....	1-143
1-8	Photometric Stereo Image Input (using FHV Controller).....	1-144
1-8-1	Settings Flow (Photometric Stereo Image Input (using FHV Controller)) ...	1-146
1-8-2	Image Input Settings (Photometric Stereo Image Input (using FHV Controller))	1-147
1-8-3	Screen Adjust (Photometric Stereo Image Input (using FHV Controller)) ..	1-155
1-8-4	Filter (Photometric Stereo Image Input (using FHV Controller)).....	1-160
1-8-5	Output Image (Photometric Stereo Image Input (using FHV Controller)) ...	1-164
1-8-6	White Balance (Photometric Stereo Image Input (using FHV Controller))..	1-164
1-8-7	Calibration (Photometric Stereo Image Input (using FHV Controller)).....	1-164
1-8-8	Lens Adjustment (Photometric Stereo Image Input (using FHV Controller))	1-164
1-8-9	Camera Model (Photometric Stereo Image Input (using FHV Controller)) .	1-166
1-8-10	External Reference Tables (Photometric Stereo Image Input (using FHV Controller))	1-166
1-9	Camera Switching	1-167
1-9-1	Camera Selection (Camera Switching).....	1-167
1-9-2	Additional Explanation (Camera Switching).....	1-168
1-9-3	External Reference Tables (Camera Switching)	1-168
1-10	Measurement Image Switching.....	1-169
1-10-1	Parameter Settings (Measurement Image Switching)	1-169
1-10-2	Key Points for Test Measurement and Adjustment (Measurement Image Switching).....	1-170
1-10-3	External Reference Tables (Measurement Image Switching).....	1-171
1-11	Multi-trigger Imaging.....	1-172
1-11-1	Mode and Timeout (Multi-Trigger Imaging).....	1-173
1-11-2	Key Points for Adjustment	1-174
1-11-3	External Reference Tables (Multi-Trigger Imaging)	1-175
1-12	Multi-trigger Imaging Task.....	1-176

1-1 Camera Image Input

This is a processing item specialized for the FZ5 Sensor Controller.

Set the conditions for loading images from the camera and for storing images of the measured objects. This processing item must be used when measuring.

In addition, it is possible to shoot images with different shutter speeds, or lighting by adding multiple Camera Image Input to your flow.

Used in the Following Case

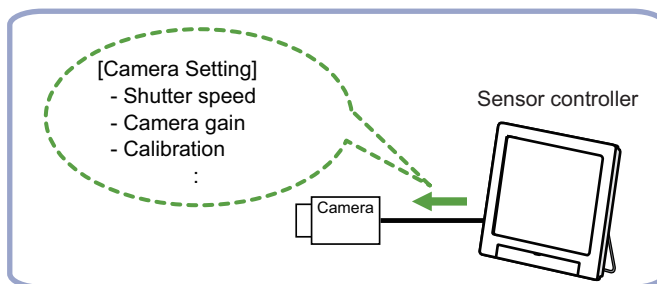

Precautions for Correct Use

- *Camera Image Input* is preset for Unit 0. Do not set any processing item other than camera image input (*Camera Image Input FH*, *Camera Image Input HDR*, *Camera Image Input HDR Lite*, *Photometric Stereo Image Input*) for Unit 0.
- When switching from a color camera to a monochrome or switching to a camera with a different resolution, reset the following units.
- If a camera is connected which is different from the one for the previous settings, the camera settings are returned to their initial settings.
- For this processing item, do not use scene variables or system-defined variables as parameters.
- Just after starting up the Sensor Controller or just after changing scenes, it becomes no image input. In this state, it is set to the same color image processing as in the factory default state.
- When the *Properties* dialog box is opened with no image input, click the **Cancel** button to close the dialog box. Pressing the **OK** button in the dialog box will change the setting to the same color camera setting as the factory default state.
For details, *FAQ - For Measurement - The measurement NG (image mismatch) error will result when connecting a monochrome camera in the Vision System FH/FHV Series User's Manual* (Cat. No. Z365).
- When using multiple *Camera Image Input*, the processing time is longer than multiple times the processing time of the *Camera Image Input* because the parameters need to be changed.
- If there is only one *Camera Image Input* in the measurement flow, do not change the *Camera Image Input* parameters in the measurement flow during measurement.
- When the Scene data created via FZ series Sensor Controller, i.e. FZ5 series or FZ5-L series, *Camera Image Input* is automatically converted to *Camera Image Input FH*.
- The automatically converted contents are the common items between *Camera Image Input* and *Camera Image Input FH*. The other settings are set to the default settings of the connected camera to SF series Sensor Controller.
- When FZ series Sensor Controller is used to load the data created by FH series Sensor Controller, the data is not automatically converted.

1-1-1 Settings Flow (Camera Image Input)

To set Camera Image Input, follow the steps below.

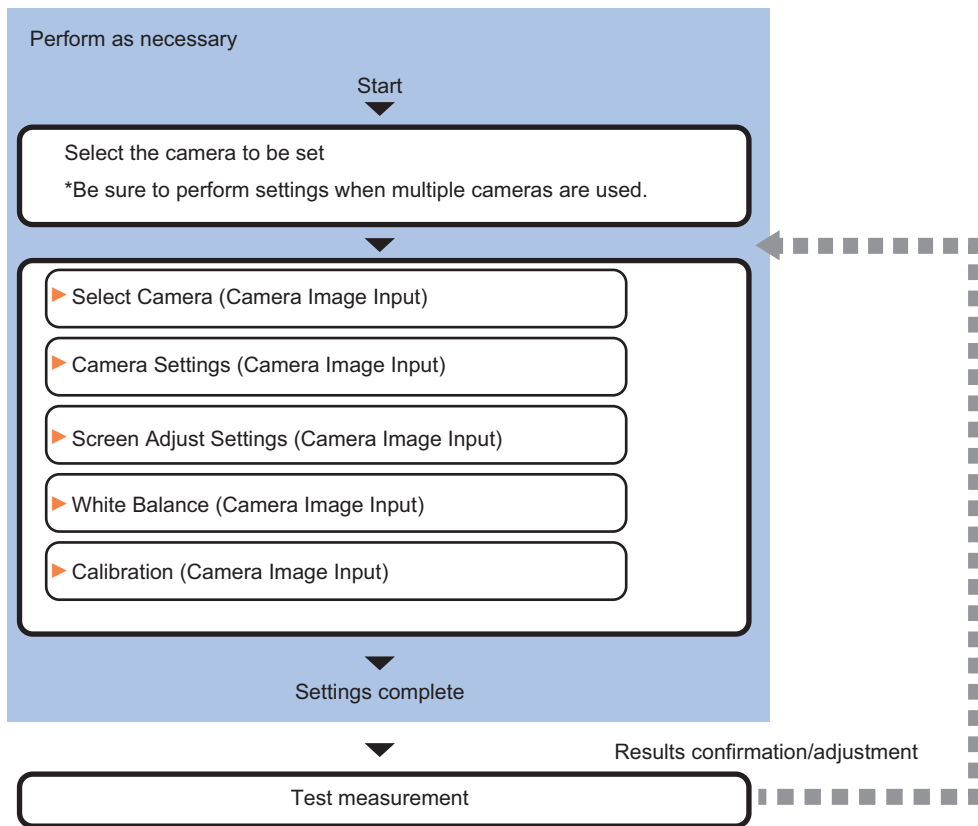

List of Camera Image Input Items

Item	Description
Camera 0 to 3	Select the camera to be set.
Select camera	When multiple cameras are connected, select the camera to use for measurement. <i>1-1-2 Select Camera (Camera Image Input) on page 1-5</i>
Camera settings	Specify the camera settings such as the shutter speed or electronic flash. <i>1-1-3 Camera Settings (Camera Image Input) on page 1-6</i>
Screen adjust	Adjust the lighting and the lens. <i>1-1-4 Screen Adjustment Settings (Camera Image Input) on page 1-11</i>
White balance	When using a color camera, adjust the white balance. <i>1-1-5 White Balance (Camera Image Input) on page 1-19</i>
Calibration	Set when measurements (camera coordinate measurement values) are to be output using actual dimensions. Select the calibration setting method and generate the calibration parameters. <i>1-1-6 Calibration (Camera Image Input) on page 1-21</i>

1-1-2 Select Camera (Camera Image Input)

When multiple cameras are connected, select the camera to use for measurement.

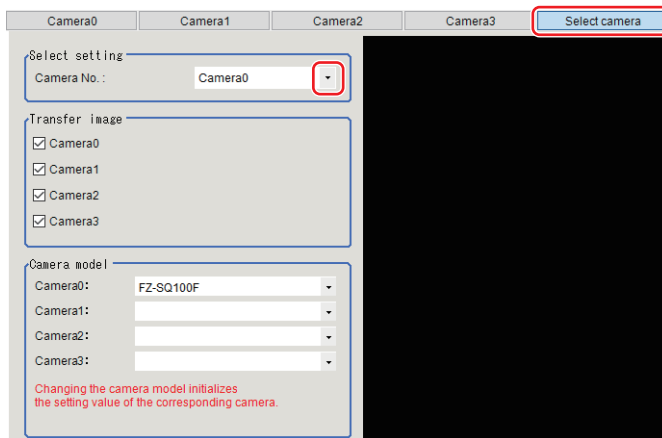

- 1** In the Item Tab area, click **Select camera**.
- 2** Click ▼ on the right of the *Camera No.* and select the camera number.
- 3** If multiple cameras are connected, the camera to transfer images for can be selected. Unchecking checkboxes for cameras not being used for the current Scene or cameras not for the logging target can omit the image transfer processing after those image inputs.



Precautions for Correct Use

Transfer of images for Camera 0 is executed at the same time as image input. Therefore, even if you uncheck the checkbox for Camera 0, the image transfer time is not shortened.

- 4** A camera model currently connected can be checked in the *Camera model* area.



Additional Information

When using the simulation software, you can select any camera model in the *Camera model* area. Changing the camera model will initialize the correspondence camera settings.



Additional Information

The image from the camera selected in *Select camera* will be the object to be measured in the following units.

When you need to switch the camera during the process, insert the *Camera Switching* unit in the scene to switch the image.

For details, refer to *1-9 Camera Switching* on page 1-167.

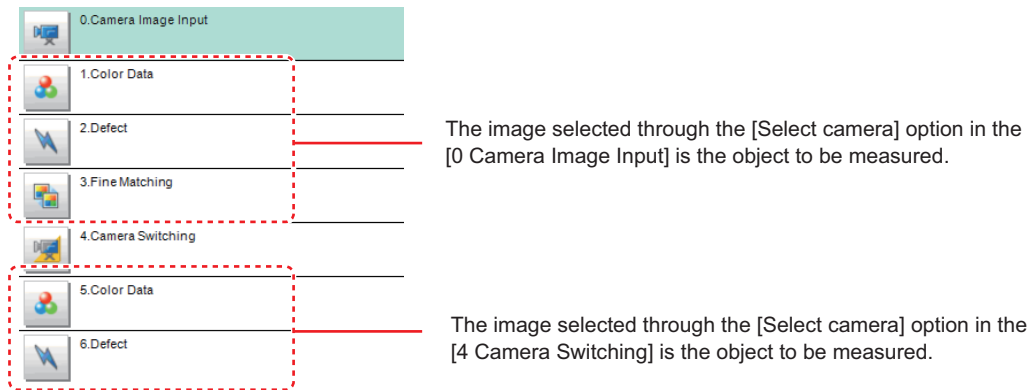

1-1-3 Camera Settings (Camera Image Input)

Set the following photographing conditions for each camera.

- *Camera Settings* on page 1-6
- *Frame/Field - for Monochrome Cameras Only* on page 1-8
- *Number of Lines to be Read* on page 1-9
- *Electronic Flash Settings* on page 1-10



Additional Information

The display items differ depending on the camera model and lighting mode. Perform the setting with the following procedures according to the usage environment.

Camera Settings

Adjust the settings related to camera shutter speed and camera gain.

Set the shutter speed appropriate to the speed of the measurement object. Choose a faster shutter speed if the measurement object is moving quickly and the image is blurred.

Adjust the camera gain when images cannot be brightened through the shutter speed, lens aperture, or lighting conditions. Usually, the factory default values can be used.

Camera gain	Image quality	Image
200	Very poor (too much noise)	bright
0	Very good (less noise)	dark

[Factory defaults: 85]

1 In the Item tab area, click **Camera setting**.

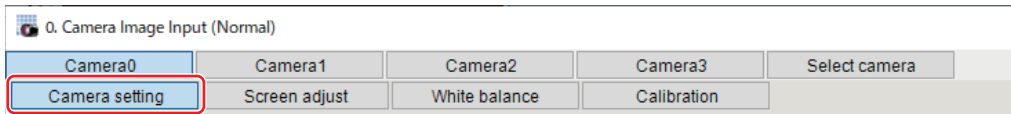

2 In the *Camera settings* area, specify the shutter speed.
For the setting methods, there are two ways: to select from the options offered or to set the value directly.

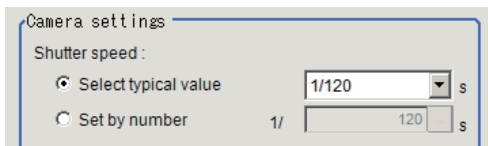

Setting item	Setting value [Factory default]	Description
Shutter speed	<p>FZ-SC/FZ-S/FZ-SHC/FZ-SH</p> <ul style="list-style-type: none"> Typical value 1/120, 1/200, [1/500], 1/1,000, 1/2,000, 1/4,000, 1/8,000, 1/20,000 Set by number 1/10 to 1/50,000 <p>FZ-SC2M/FZ-S2M/FZ-SC5M <input type="checkbox"/>/FZ-S5M <input type="checkbox"/>/FZ-SF <input type="checkbox"/>/FZ-SP <input type="checkbox"/></p> <ul style="list-style-type: none"> Typical value [1/120], 1/200, 1/500, 1/1,000, 1/2,000, 1/4,000, 1/8,000, 1/20,000 Set by number 1/10 to 1/50,000 <p>FZ-SQ <input type="checkbox"/><input type="checkbox"/><input type="checkbox"/><input type="checkbox"/></p> <ul style="list-style-type: none"> Typical value 1/250, 1/500,[1/1,000], 1/2,000, 1/4,000, 1/8,000, 1/16,000, 1/30,000 Set by number 1/250 to 1/30,000 	The <i>shutter speed</i> value to set depends on a camera type.

3 Specify the camera gain while checking the image.

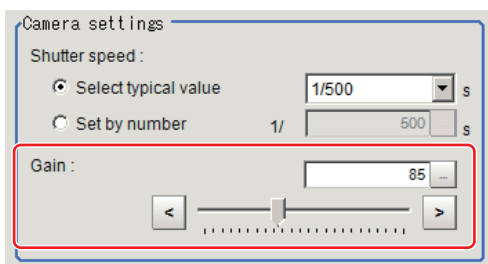

Setting item	Setting value [Factory default]	Description
Camera gain	FZ-SC/FZ-S/FZ-SHC/FZ-SH 0 to 230 [85] FZ-SC2M/FZ-S2M/FZ-SC5M □/FZ-S5M □/FZ-SF □/FZ-SP □ 0 to 230 [50] FZ-SC5M3 0 to 230 [65] FZ-SQ □□□□ 16 to 64 [16]	Adjusts the <i>Camera gain</i> when the shutter speed, the lens aperture, and lighting conditions cannot be used to brighten the image. Usually, the factory default value can be used.



Precautions for Correct Use

- When an Intelligent Compact Digital camera, FZ-SQ□□□□, is connected, we recommend setting the gain value to 16 for stable operations. Measurement values may be different if the recommended value is exceeded. Be sure to thoroughly check the measurement result and set the gain value.
- When performing defect inspection, keep the gain setting at a low value to suppress the influence of image noise.

Frame/Field - for Monochrome Cameras Only

There are two methods to transfer one image from a camera to the sensor controller: frame read and field read. Frame read is to read all of the scanned lines of the image. The result is called a frame image. Field read is used to read half of the interlaced scanned lines of the image. The result is called the field image.

Here, select the unit to be treated as one image.

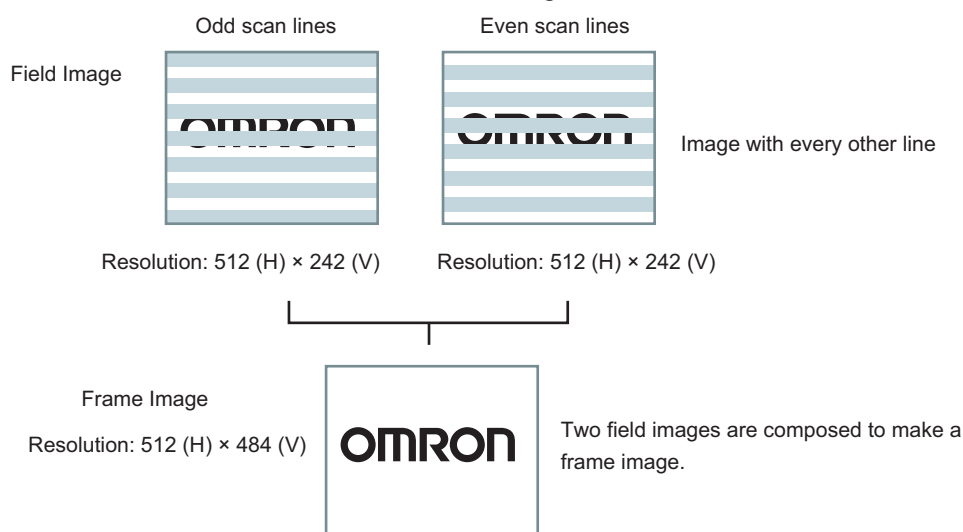

- 1** In the Item Tab area, click **Camera setting**.
- 2** In the *Frame/Field* area, select either *Frame* or *Field*.

Setting item	Setting value [Factory default]	Description
Flame/Field	<ul style="list-style-type: none"> • [Frame] • Field 	<ul style="list-style-type: none"> • Frame Measurements are done in frame units. • Field Measurements are done in field units. Select "Field" when you prefer shorter image input time rather than higher accuracy. Processing becomes faster since each image is scanned skipping one scan line per two consecutive lines, but the measurement precision is decreased because the vertical image resolution is lower.

Number of Lines to be Read

By narrowing the image range to be loaded, the image scan time can be shortened.

Set the range taking the offset of the measurement object into consideration.

The part of the image narrowed down by the start line and the end line will be displayed in the setting screen of the processing item window and the Image Display area of the Main screen.

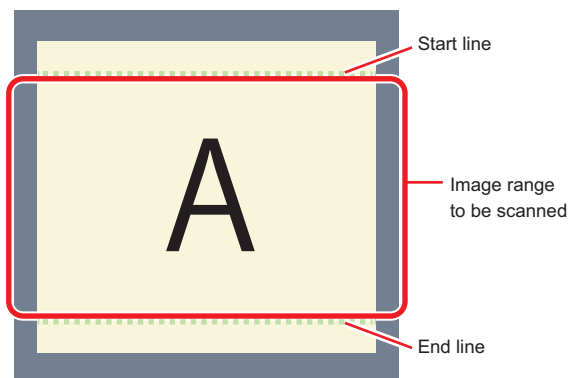

Additional Information

About the minimum number of lines:

- The minimum number of lines (minimum number of lines between start and end lines) is 12 lines.
- For FZ-S□5M2, set the end line within a range from 1921 to 2043.
- For the FZ-S□□□□ excluding FZ-SQ series and FZ-S □ 5M3, the minimum number of lines is 12 lines.
- For the FZ-SQ series, the minimum number of lines is 8 lines.
- For the FZ-S□5M3, the minimum number of lines is 4 lines.
- For the FZ-S□ M3, the step width for the start and end lines is 4 lines.
- When loading a scene created with the FZ-S□5M2, the number of loading lines will increase a maximum of 4 lines.

About coordinate values:

- The coordinate values displayed as the measurement results are the values of the display position on the monitor.
- the coordinate values do not vary according to the settings for "Number lines to be read".

1 In the Item tab area, click **Camera setting**.

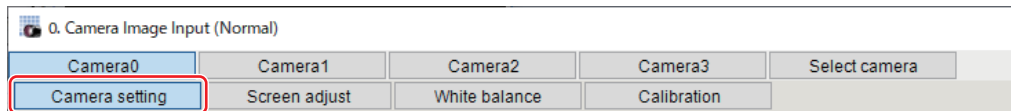

- 2 Set the start and end lines in the *Number of Lines to be Read* area.

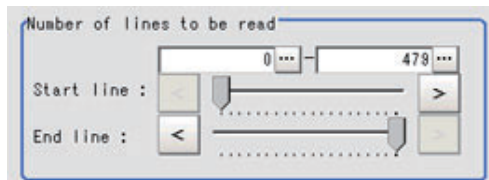

Precautions for Correct Use

- When the built-in lighting of an FZ-SQ□□□□ is used, it may not be possible to shorten the processing time due to restrictions on the light emission time.
- If the following cameras are used with the **frame / field** setting set to *field*, set the number of capture lines to be a multiple of 8.
FZ-S5M3

Electronic Flash Settings

This function is set when an electronic flash is used. This sets the output conditions for the signal to synchronize the measurement and the electronic flash timing.

- 1 In the Item tab area, click **Camera setting**.

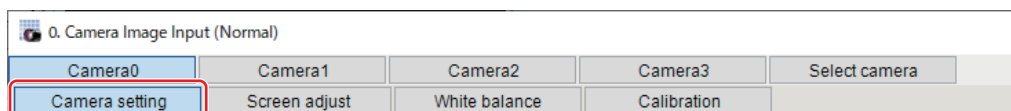

- 2 In the *Electronic flash setting* area, specify each item.

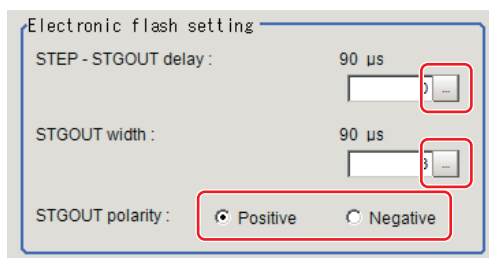

Setting item	Setting value [Factory default]	Description
STEP-STGOUT delay	0 to 511 [0] (1 count: 30 [μs])	Sets the waiting time from the time the start of this camera image input processing item until the electronic flash trigger output signal comes ON. Delay time = Count × 30 μs + 90 μs The delay time varies depending on the <i>polarity of STGOUT pulse</i> . The displayed time is for the positive polarity. Add 35 [μs] to the displayed time when the polarity is negative. The display time becomes within a range of ±10 [μs] to the setting value.
STGOUT width	1 to 63 [3] (1 count: 30 [μs])	Sets the output time for the electronic flash trigger signal.
STGOUT polarity	<ul style="list-style-type: none"> [Positive] Negative 	Selects the pulse polarity of the electronic flash trigger. <ul style="list-style-type: none"> Positive polarity Flashes synchronized with the timing of the electronic flash trigger output signal changing from OFF to ON. Negative polarity Flashes synchronized with the timing of the electronic flash trigger output signal changing from ON to OFF.



Precautions for Correct Use

- Do not perform next camera image input processing before STGOUT signal output is completed. If it were done, STGOUT signal may not be output. Perform camera image input processing after STGOUT signal output is completed or set the STEP-camera delay, STEP-STGOUT delay, and STGOUT pulse width properly so that the electronic flash flashes synchronizing with the exposure time.
- When you want the electronic flash to light synchronously with the exposure time, set the delay between STEP and the camera or the delay between STEP and STGOUT, taking into consideration the response time of the external strobe controller.

1-1-4 Screen Adjustment Settings (Camera Image Input)

Set the lighting and lens conditions for each camera.

- Lighting Control* on page 1-11
- Line Bright* on page 1-18

Lighting Control

When an Electronic flash controller or Camera-mount Lighting controller is connected, the light volume of the lighting can be adjusted from the Sensor Controller. Moreover, adjusting brightness automatically or selecting one of the preset patterns are also possible.

- In the Item tab area, click **Screen adjust**.

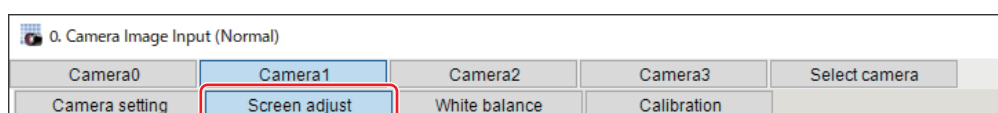

- 2** In the *Lighting control* area, specify the brightness.
Displayed contents vary depending on the connected camera, electronic flash controller, or camera-mount lighting controller.

● **Intelligent Compact Digital Camera FZ-SQ□□□□ is Connected:**

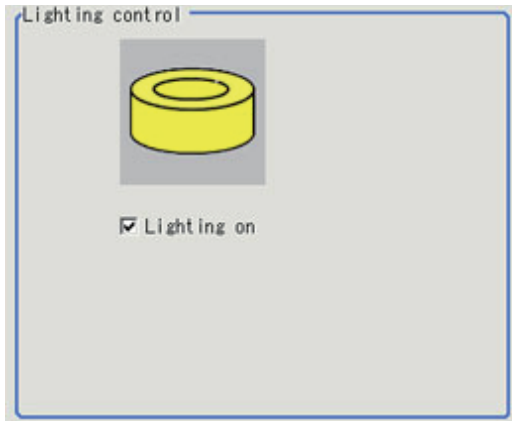

Setting item	Setting value [Factory default]	Description
Lighting on	<ul style="list-style-type: none"> • [Checked] • Unchecked 	Unchecks the checkbox when no lighting is used.



Precautions for Correct Use

When the lighting of FZ-SQ □□□□ is used, there are following restrictions.

- The measurement processing time with the lighting on can become longer than that with the lighting off.
- There are restrictions in the operation of Multi-trigger Imaging. For details, refer to *1-11 Multi-trigger Imaging* on page 1-172.

● **Camera-mount Lighting Controller FL-TCC1 is Connected:**

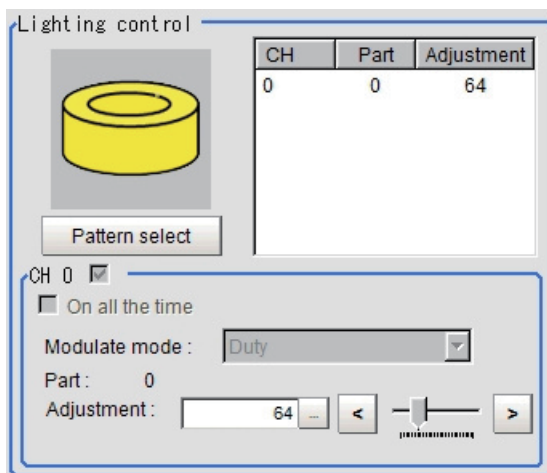

Setting item	Setting value [Factory default]	Description
Pattern select	-	Selects one of the preset lighting patterns.
Part	0 to 255 [64]	Sets the brightness for the selected parts.



Precautions for Correct Use

Per its specifications, the FL-TCC1 cannot emit light longer than 50ms. For that reason, note the following restrictions.

- Even if the shutter speed is increased to 50ms or more, it does not become brighter. To avoid this restriction, use the FLV-TCC .

● Camera-mount Lighting Controller FLV-TCC1 is Connected:

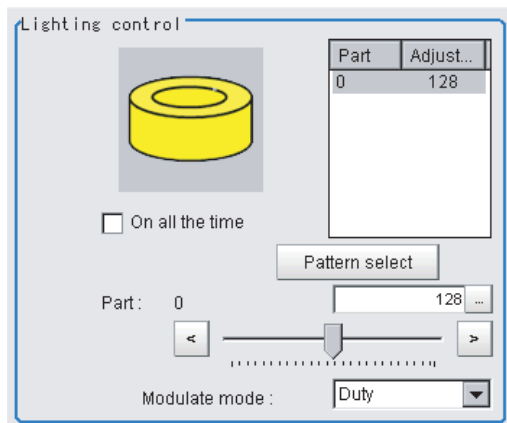

Setting item	Setting value [Factory default]	Description
Pattern select	-	Selects one of the preset lighting patterns.
On all the time	<ul style="list-style-type: none"> • Checked • [Unchecked] 	Places a check here to keep the lighting turned ON all of the time regardless of the exposure time.
Modulate mode	<ul style="list-style-type: none"> • [Duty] • Voltage/Current 	Selects the lighting adjustment method. <ul style="list-style-type: none"> • Duty The light emitting volume is adjusted with a pulse width of 255 gradation (PWM frequency: 100 kHz). • Voltage/Current The light emitting volume is adjusted with voltage/current levels of 255 gradation. Selects voltage/current adjustment when using this with a high-speed shutter speed.
Part	0 to 255 [128]	Sets the brightness for the selected parts.



Precautions for Correct Use

Per its specifications, the FL-TCC1 cannot emit light longer than 50ms. For that reason, note the following restrictions.

- Even if the shutter speed is increased to 50ms or more, it does not become brighter. To avoid this restriction, use the FLV-TCC .

● Camera-mount Lighting Controller FLV-TCC4 is Connected:

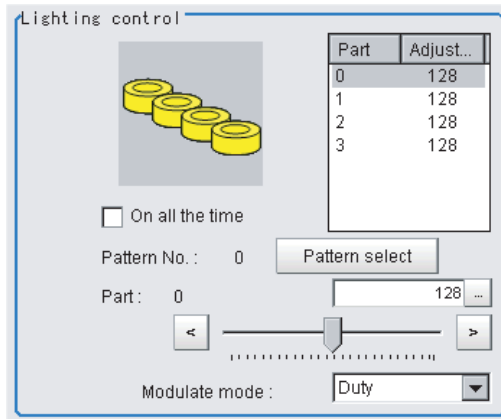

Setting item	Setting value [Factory default]	Description
Pattern select	-	Selects one of the preset lighting patterns.
On all the time	<ul style="list-style-type: none"> • Checked • [Unchecked] 	Places a check here to keep the lighting turned ON all of the time regardless of the exposure time.
Modulate mode	<ul style="list-style-type: none"> • [Duty] • Voltage/Current 	Selects the lighting adjustment method. <ul style="list-style-type: none"> • Duty The light emitting volume is adjusted with a pulse width of 255 gradation (PWM frequency: 100 kHz). • Voltage/Current The light emitting volume is adjusted with voltage/current levels of 255 gradation. Selects voltage/current adjustment when using this with a high-speed shutter speed.
Part	0 to 255 [128]	Sets the brightness for the selected parts.

● Camera-mount Lighting Controller FLV-TCC1EP is Connected:

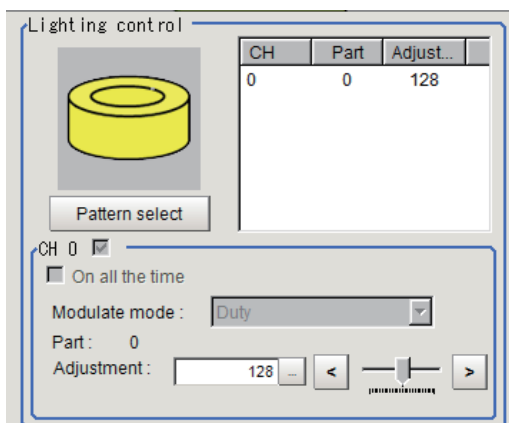

Setting item	Setting value [Factory default]	Description
Pattern select	-	Selects one of the preset lighting patterns.
On all the time	<ul style="list-style-type: none"> • Checked • [Unchecked] 	Places a check here to keep the lighting turned ON all of the time regardless of the exposure time.

Setting item	Setting value [Factory default]	Description
Modulate mode	<ul style="list-style-type: none"> [Duty] Voltage/Current 	<p>Selects the lighting adjustment method.</p> <ul style="list-style-type: none"> Duty The light emitting volume is adjusted with a pulse width of 255 gradation (PWM frequency: 100 kHz). Voltage/Current The light emitting volume is adjusted with voltage/current levels of 255 gradation. <p>Selects voltage/current adjustment when using this with a high-speed shutter speed.</p>
Part	0 to 255 [128]	Sets the brightness for the selected parts.

● **Camera-mount Lighting Controller FLV-TCC3HB is Connected:**

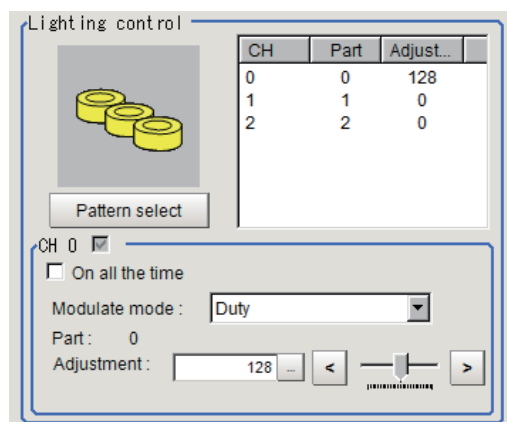

Setting item	Setting value [Factory default]	Description
Pattern select	-	Selects one of the preset lighting patterns.
On all the time	<ul style="list-style-type: none"> Checked [Unchecked] 	Places a check here to keep the lighting turned ON all of the time regardless of the exposure time.
Modulate mode	<ul style="list-style-type: none"> [Duty] Voltage/Current 	<p>Selects the lighting adjustment method.</p> <p>0ch connected:</p> <ul style="list-style-type: none"> Duty The light emitting volume is adjusted with a pulse width of 255 gradation (PWM frequency: 100 kHz). Voltage/Current The light emitting volume is adjusted with voltage/current levels of 255 gradation. <p>0ch is for the spotlighting.</p> <p>1ch / 2ch connected:</p> <p>Selects voltage/current adjustment when using this with a high-speed shutter speed.</p>
Part	0 to 255 [128]	Sets the brightness for the selected parts.



Precautions for Correct Use

- There is no restriction on power consumption nor on emitting mode when using lighting with lighting controller FLV-TCC1EP.
- Restrictions on power consumption and emitting mode vary depending on your product. See the following table for details.

(1) FLV-TCC4/FLV-TCC1

- Without external power supply

Total power consumption	Power consumption per channel	Connectability	Lighting mode* ¹			READY OFF time delay* ¹
			Always-on	simultaneous	Single	
Greater than 7.5W	Greater than 7.5W	Not connectable	-	-	-	-
	7.5W or less	Connectable	NA	NA	OK	None
7.5W or less	Less than 7.5W	Connectable	OK	OK	OK	None

- With external power supply

total power consumption	Power consumption per channel	Connectability	Lighting mode* ¹			READY OFF time delay* ¹
			Always-on	Simultaneous	Single	
Greater than 15W	Greater than 15W	Not connectable	-	-	-	-
	15W or less	Connectable	NA	NA	OK	Yes
	7.5W or less	Connectable	NA	NA	OK	None
15W or less	Less than 15W	Connectable	NA	OK	OK	Yes
	7.5W or less	Connectable	NA	OK	OK	Yes
7.5W or less	Less than 7.5W	Connectable	OK	OK	OK	None

(2) FLV-TCC3HB

- Without external power supply

0ch (spot lighting) not connected

Total power consumption (1ch/2ch)	Power consumption per channel	Connectability	Lighting mode* ¹			READY OFF time delay* ¹
			Always-on	Simultaneous	Single	
Greater than 7.5W	Greater than 7.5W	Not connectable	-	-	-	-
	7.5W or less	Connectable	NA	NA	OK	None
7.5W or less	Less than 7.5W	Connectable	OK	OK	OK	None

0ch (spot lighting) connected:

Total power consumption (1ch/2ch)	Power consumption per channel	Connectability	Lighting mode*1			READY OFF time delay*1
			Always-on	Simultaneous	Single	
Greater than 5.5W	Greater than 7.5W	Not connectable	-	-	-	-
	7.5W or less	Connectable	NA	NA	OK	None
5.5W or less	Less than 5.5W	Connectable	OK	OK	OK	None

- With external power supply

0ch (spot lighting) not connected

Total power consumption (1ch/2ch)	Power consumption per channel	Connectability	Lighting mode*1			READY OFF time delay*1
			Always-on	Simultaneous	Single	
Greater than 15W	Greater than 15W	Not connectable	-	-	-	-
	15W or less	Connectable	NA	NA	OK	Yes
	7.5W or less	Connectable	NA	NA	OK	None
15W or less	Less than 15W	Connectable	NA	OK	OK	Yes
	7.5W or less	Connectable	NA	OK	OK	Yes
7.5W or less	Less than 7.5W	Connectable	OK	OK	OK	None

0ch (spot lighting) connected:

Total power consumption	Power consumption per channel	Connectability	Lighting mode*1			READY OFF time delay*1
			Always-on	Simultaneous	Single	
Greater than 14W	Greater than 15W	Not connectable	-	-	-	-
	15W or less	Connectable	NA	NA	OK	Yes
	7.5W or less	Connectable	NA	NA	OK	None
14W or less	Less than 14W	Connectable	NA	OK	OK	Yes
	7.5W or less	Connectable	NA	OK	OK	Yes
7.5W or less	Less than 7.5W	Connectable	OK	OK	OK	None

- *1. • Lighting modes

Always-on lighting mode	The lighting is always turned on by a constant pulse cycle. This mode is enabled when placing a check in the <i>On all the time</i> in the <i>Lighting control</i> area.
-------------------------	--

Simultaneous lighting mode	All lighting connected is synchronously turned on with the trigger. Set the <i>Adjustment</i> in the <i>Lighting control</i> area for each lighting to any value other than 0.
Single lighting mode	Only one lighting is synchronously turned on with the trigger. Set the <i>Adjustment</i> of one part in the <i>Lighting control</i> area to any value other than 0. When two or more channels are set to any value other than 0, the lighting will not be turned on.

- READY OFF time delay

The turning OFF time for the READY signal will be delayed for approximately the exposure time compared to no camera-mount lighting controller connected.

(Example) Connection example for connecting an external power supply, and the lighting modes.

- When four lighting with a power consumption of 1 W each are connected to a camera-mount lighting controller, all lighting modes (Always-on, Simultaneous, and Single) are available.
- When four lighting with power consumptions of 2W, 3W, 4W, and 5W each are connected to a camera-mount lighting controller, two lighting modes (Simultaneous and Single) are available.
- When four lighting with power consumptions of 12W, 1W, 2W, and 1W each are connected to a camera mount lighting controller, Single lighting mode is only available.

Line Bright

A graph showing gray distribution for one line in the image is called the *Line bright*. Each line bright corresponding to R, G, B for any line in horizontal and vertical directions is displayed.

1 In the Item tab area, click **Screen adjust**.

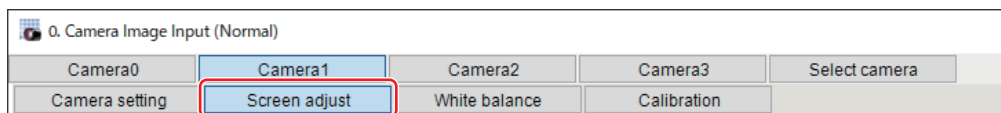

2 Place a check to the *Display line bright*.

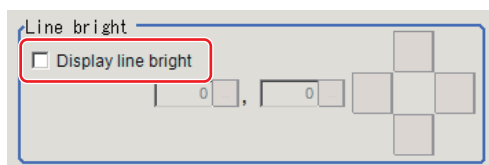

3 Move the line to a position whose density distribution is desired to see.

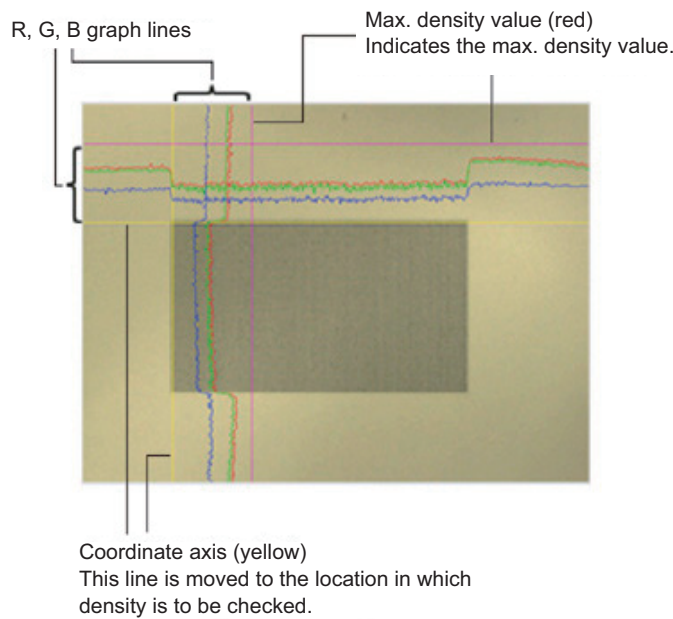

1-1-5 White Balance (Camera Image Input)

This feature compensates the color of images loaded from a camera and sets the white balance to make white objects look white.

By adjusting the white balance, proper white color is reproduced with any type of lighting. Moreover, optimum values can also be set automatically.



Additional Information

- The white balance setting is only available when a color camera is used.
- In the following cases, make sure to set the white balance.
 - Newly installed
 - A camera or lighting is changed

Since measurement results may vary with changes in the white balance settings, make sure to verify the operation.

- 1 In the Item tab area, click the **White balance**.

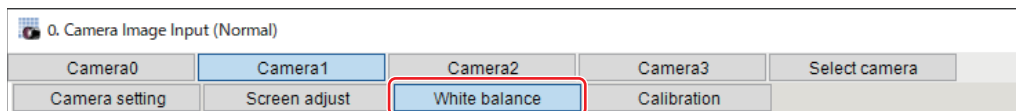

- 2 Shoot a white piece of paper or cloth.

- 3 Click the **Auto**.

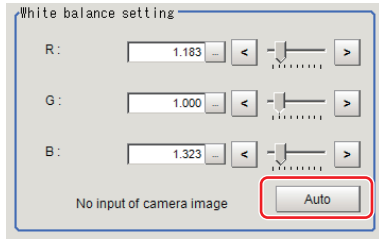

Additional Information

When the *Too bright* or *Too dark* message is displayed, adjust the iris, shutter speed, gain and/or lighting conditions until *Automatic adjustment is possible.* is displayed.

- 4** Set the *R*, *G*, and *B* values as necessary.

Setting item	Setting value [Factory default]	Description
White balance setting	0.001 to 7.999 (R, G, B respectively) (FZ-SQ □□□□ 0.001 to 3.000)	Adjusts the white balance. Whiteness increases when the value of <i>R</i> , <i>G</i> , and <i>B</i> is increased.
• R	FZ-SC	
• G	[R=1.183]	
• B	[G=1.000]	
	[B=1.323]	
	FZ-SC2M	
	[R=1.394]	
	[G=1.000]	
	[B=1.222]	
	FZ-SHC	
	[R=1.375]	
	[G=1.000]	
	[B=1.452]	
	FZ-SFC/FZ-SPC	
	[R=1.145]	
	[G=1.000]	
	[B=1.889]	
	FZ-SC5M2	
	[R=1.351]	
	[G=1.000]	
	[B=2.314]	
	FZ-SC5M3	
	[R=1.400]	
	[G=1.000]	
	[B=2.150]	
	FZ-SQ □□□□	
	[R=1.000]	
	[G=1.040]	
	[B=1.800]	

1-1-6 Calibration (Camera Image Input)

By setting the calibration, the measurement result can be converted and output as actual dimensions. The calibration method is selected here.

There are three calibration methods, point, sampling, and parameter.

- *Specifying Points and Setting (Point Specification)* on page 1-21
- *Setting Calibration through Sampling Measurement (Sampling)* on page 1-22
- *Inputting and Setting Values (Value Setting)* on page 1-24
- *View Calibration Parameters* on page 1-26



Additional Information

For outputting measurement values in actual dimensions, select the *Calibration* in the *Output parameter* for each processing unit to *ON*. When the *Calibration* is *OFF* (factory default), then measurement values are output as camera image coordinates.

Specifying Points and Setting (Point Specification)

This is a method for performing calibration by selecting arbitrary points (in pixels).

Calibration parameters are automatically calculated by entering actual coordinates of selected positions. Up to three points are possible to select.

- When the magnification of X and Y directions is the same:
Select two points.

X : Y = 1 : 1

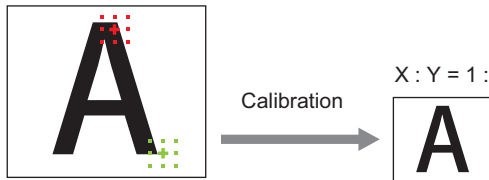

- When the magnification of X and Y directions is not the same:
Select three points.

X : Y = 5 : 3

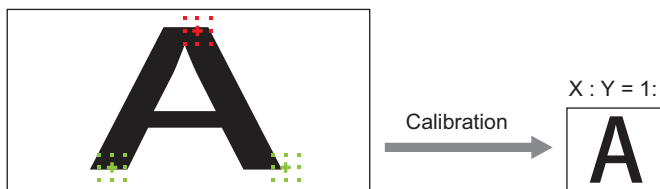

Additional Information

When two points are selected, the coordinate system is set to the left-handed system (clockwise). When performing the calibration including the coordinate system, select three points.

- 1 In the Item tab area, click the **Calibration**

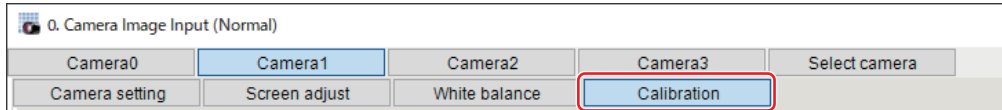

2 In the Calibration setting area, select the *Specify point*.

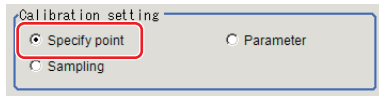

3 Click the first point on the screen.

4 Set the actual coordinates for the specified point. The actual coordinate input window is displayed.

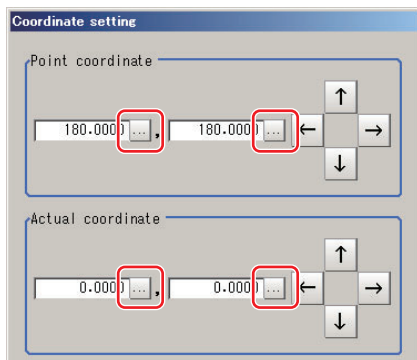

Setting item	Setting value [Factory default]	Description
Point coordinate X, Y	0 to 9,999.9999 [Point clicked in the window]	-
Actual coordinate X, Y	-99,999.9999 to 99,999.9999 [0]	-

5 Set the second and third points in the same way.

6 Click the **Generate calibration parameters**. The calibration parameters will be generated.

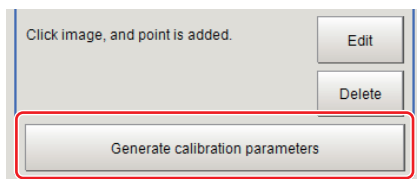

Setting Calibration through Sampling Measurement (Sampling)

This is a method for setting calibration based on measurement results.

Calibration parameters are automatically calculated by searching a registered model and setting the actual coordinate of the position.

- 1 In the Item tab area, click the **Calibration**

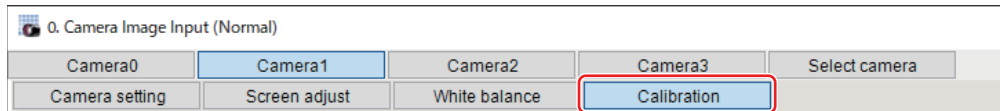

- 2 In the *Calibration setting* area, select the *Sampling*.

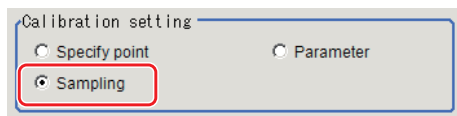

- 3 In the *Sampling* area, click the **Register model**.

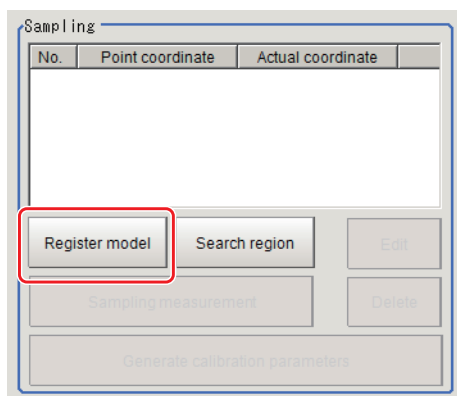

- 4 Register the model with the Drawing tools.

- 5 Set a search region as necessary.
The initial value is the entire screen.

- 6 Click **Sampling measurement**.
Measurement is performed.
The search result (crosshair cursor) is displayed in the *Image Display* area and the *Sampling Coordinate* window is displayed.

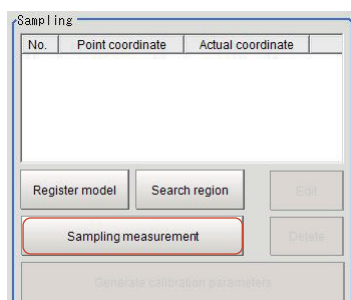

- 7** In the *Sampling Coordinate* window, set the X and Y values.

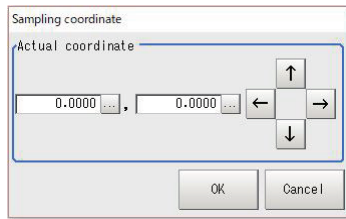

- 8** Click **OK**

The point coordinates and actual coordinates are registered in the *Sampling* area.

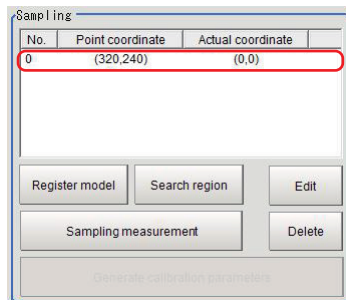

- 9** Move the measurement object and repeat the step 3 to 8.

- 10** Click the **Generate calibration parameters**.
The calibration parameters will be generated.

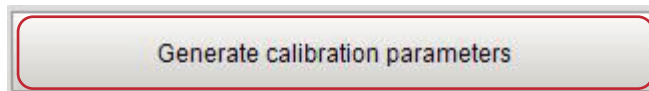

Inputting and Setting Values (Value Setting)

Set calibration data directly with numerical values.

- 1** In the Item tab area, click the **Calibration**

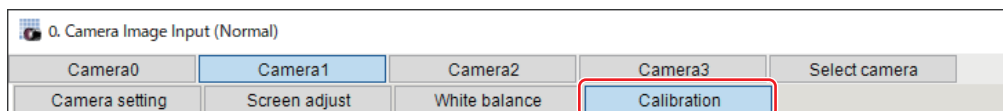

- 2** In the *Calibration setting* area, select the *Parameter*.

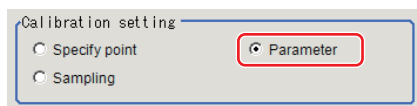

- 3** In the *Parameter* area, specify values for *Coordinate*, *Origin*, *Magnification*.

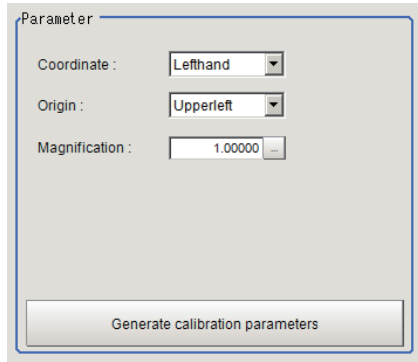

Setting item	Setting value [Factory default]	Description
Coordinate	<ul style="list-style-type: none"> [Lefthand] Righthand 	<ul style="list-style-type: none"> Lefthand The clockwise is forward when setting the coordinates. Righthand The counter-clockwise is forward when setting the coordinates. <div style="display: flex; flex-direction: column; align-items: center;"> <div style="text-align: center;"> <p>Lefthanded</p> </div> <div style="text-align: center; margin-top: 10px;"> <p>Righthanded</p> </div> </div>
Origin	<ul style="list-style-type: none"> [Upper left] Lower left Center 	<p>Sets the origin of the actual coordinates.</p> <p>Upper left of screen</p> <p>Lower left of screen</p>
Magnification	0.00001 to 9.99999	Specifies the ratio of one pixel to the actual dimensions.

- 4** Click the **Generate calibration parameters**.
The calibration parameters will be generated.

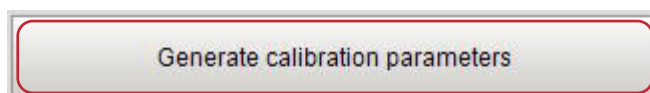

View Calibration Parameters

View the set calibration data.

- 1 In the Item tab area, click the **Calibration**

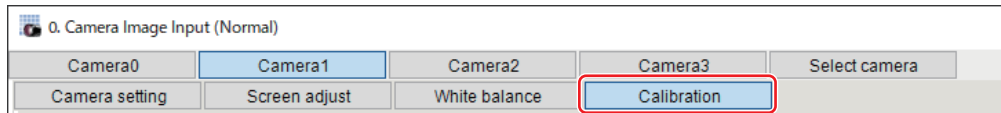

- 2 In the *Calibration parameter* area, confirm the calibration data.

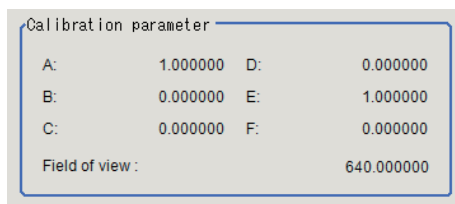

Setting item	Setting value	Description
A	Calculation value	These are calibration conversion values. Camera coordinates are converted to actual coordinates based on these values.
B	Calculation value	
C	Calculation value	
D	Calculation value	The conversion formulas for actual coordinates are as follows: (X, Y): Measurement point (camera coordinates), Unit: pixel (X', Y'): Conversion point (actual coordinates) $X' = A \times X + B \times Y + C$ $Y' = D \times X + E \times Y + F$
E	Calculation value	
F	Calculation value	
Field of view	Calculation value	
Field of view	Calculation value	An actual dimension in the X direction.

1-1-7 Additional Explanation (Camera Image Input)

Position compensation and Camera Image Input

When creating a scene, if a *Camera Image Input* unit is positioned after a *Position Compensation* processing unit, that *Position Compensation* unit will be cancelled, which will cause a new image to be read.

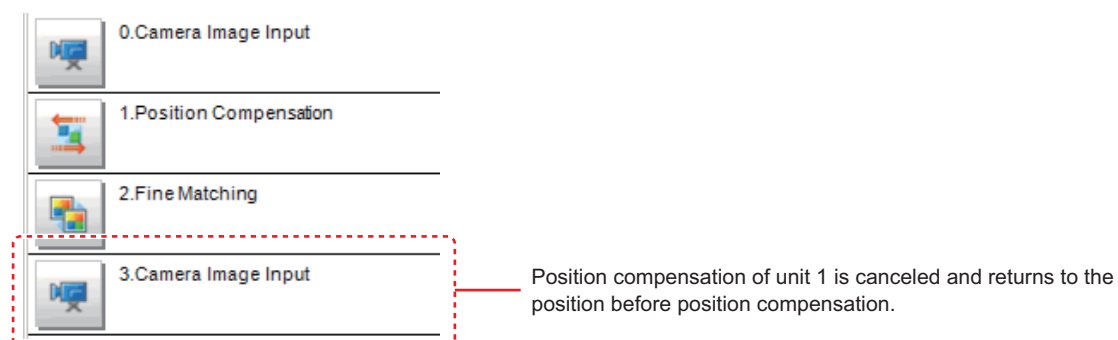

1-1-8 External Reference Tables (Camera Image Input)

No.	Data name	Data ident	Set/Get	Data range
None	Judge	judge	Get only	0: No judgment (unmeasured), 1: Judgment result OK, -1: Judgment result NG, -10: Error (image format mismatch), -11: Error (unregistered model), -12: Error (insufficient memory), -20: Error (other errors)
None	CH	lightEnabledChannel	Set/Get	0: OFF 1: ON
None	On all the time	alwaysLight	Set/Get	0: OFF 1: ON
None	Modulate mode	lightGainMode	Set/Get	It expresses the dimming method of each Part by the sum of 4 bit units. 0: Duty 1: Voltage/Current. Example: When Part 0, Part 2, and Part 5 are set to Voltage and Current, 1048833
None	STGOUT polarity	pulsePolarity	Set/Get	0: Negative 1: Positive
None	Lighting control(Site List)	lightGain	Set/Get	A representation of a lighting brightness of each Part in hexadecimal. A value of Part 0 to Part 7 is represented from left to right. Example: When the illumination brightness of Part 0 to Part 3 was set to 255 (ff), it will be ffffffff00000000.
None	Zoom	zoom	Set/Get	
None	Calibration parameter	calibParameter	Set/Get	A B C D E F separated by ","
None	White balance	whiteBalance	Set/Get	R G B separated by ","
None	Focus	focus	Set/Get	
None	Iris	iris	Set/Get	
None	Camera model	cameraModel	Set/Get	Connectable camera model name
None	Shutter speed	shutterSpeed	Set/Get	
None	Iris base density	irisDensity	Set/Get	
None	Camera No.	cameraNo	Set/Get	
None	Transfer image	cameraMask	Set/Get	Bit sum of cameras not to be transferred. 1: Camera0, 2: Camera1, 4: Camera2, 8: Camera3
None	Gain	gain	Set/Get	
None	STEP - STGOUT delay	strobeDelay	Set/Get	
None	STGOUT width	pulseWidth	Set/Get	
None	End line	endY	Set/Get	
None	Frame/Field	frameMode	Set/Get	0: Frame 1: Field
None	Start line	startY	Set/Get	

1-2 Camera Image Input FH

This is a processing item specific to the FH Sensor Controller.

Set the conditions for loading images from the camera and for storing images of the measured objects. This processing item must be used when measuring.

In addition, it is possible to shoot images whose shutter speed, or lighting differ by setting multiple Camera Image Input to your flow.

Used in the Following Case

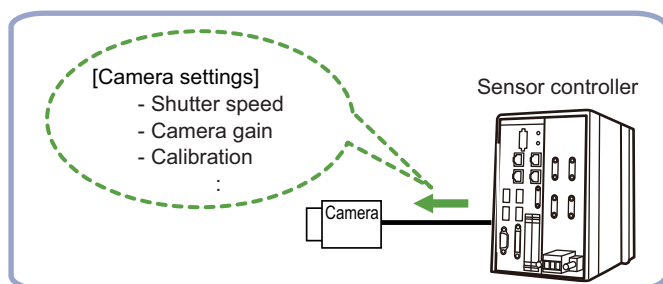

Precautions for Correct Use

- *Camera Image Input FH* is preset for Unit 0. Do not set any processing item other than camera image input (*Camera Image Input FH*, *Camera Image Input HDR*, *Camera Image Input HDR Lite*, *Photometric Stereo Image Input*) for Unit 0.
- When switching from a color camera to a monochrome or switching to a camera with a different resolution, reset the following units.
- If a camera is connected which is different from the one for the previous settings, the camera settings are returned to their initial settings.
- For this processing item, do not use scene variables or system-defined variables as parameters.
- Just after starting up the Sensor Controller or just after changing scenes, it becomes no image input. In this state, it is set to the same color image processing as in the factory default state.
- When the *Properties* dialog box is opened with no image input, click the **Cancel** button to close the dialog box. Pressing the **OK** button in the dialog box will change the setting to the same color camera setting as the factory default state.
For details, *FAQ - For Measurement - The measurement NG (image mismatch) error will result when connecting a monochrome camera in the Vision System FH/FHV Series User's Manual* (Cat. No. Z365).
- When using multiple *Camera Image Input*, the processing time is longer than multiple times the processing time of the *Camera Image Input* because the parameters need to be changed.
- If there is only one *Camera Image Input* in the measurement flow, do not change the *Camera Image Input* parameters in the measurement flow during measurement.
- When the Scene data created via FZ series Sensor Controller, i.e. FZ5 series or FZ5-L series, *Camera Image Input* is automatically converted to *Camera Image Input FH*.
- The automatically converted contents are the common items between *Camera Image Input* and *Camera Image Input FH*. The other settings are set to the default settings of the connected camera to SF series Sensor Controller.
- When FZ series Sensor Controller is used to load the data created by FH series Sensor Controller, the data is not automatically converted.

1-2-1 Settings Flow (Camera Image Input FH)

To set Camera Image Input FH, follow the steps below.

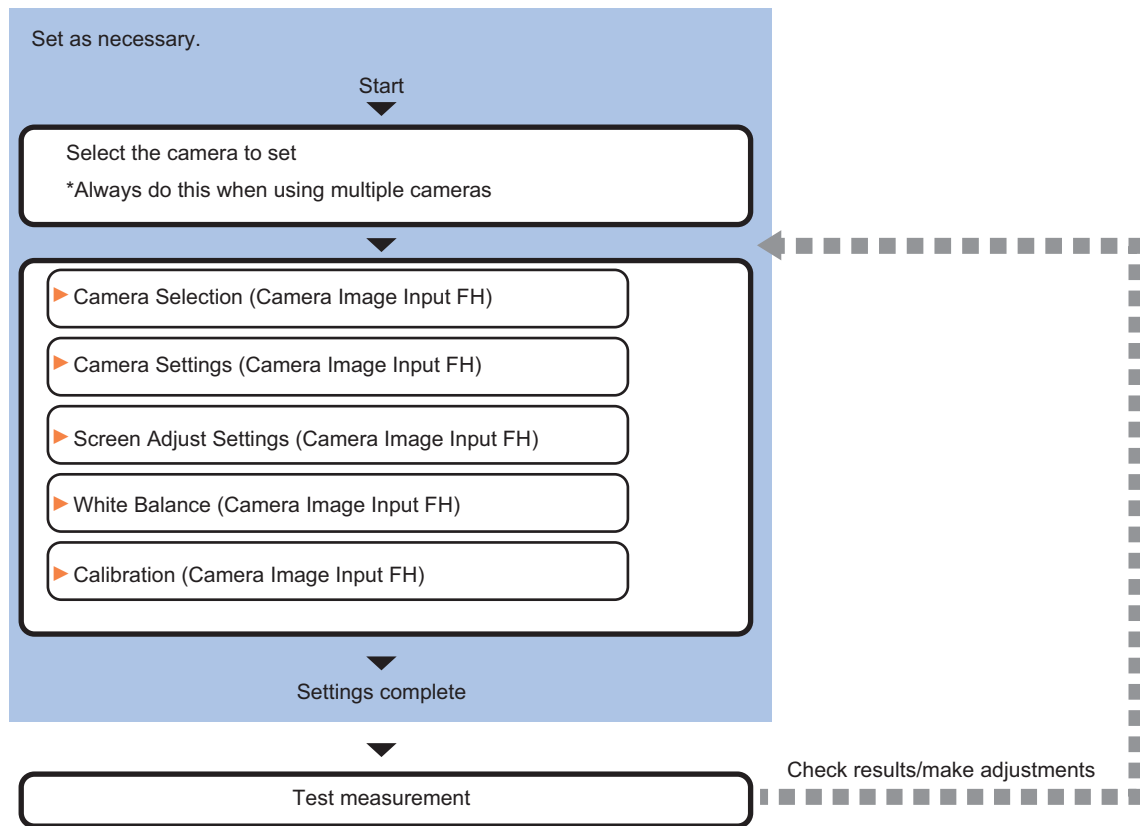

List of Camera Image Input FH Items

Item	Description
Camera 0 to 7	Select the camera to be set.
Select camera	When multiple cameras are connected, select the camera to use for measurement. <i>1-2-2 Select Camera (Camera Image Input FH) on page 1-30</i>
Camera settings	Specify the camera settings such as the shutter speed or electronic flash. <i>1-2-3 Camera Settings (Camera Image Input FH) on page 1-31</i>
Screen adjust	Adjust the lighting and the lens. <i>1-2-5 Screen Adjustment Settings (Camera Image Input FH) on page 1-41</i>
White balance	When using a color camera, adjust the white balance. <i>1-2-6 White Balance (Camera Image Input FH) on page 1-56</i>
Calibration	Set when measurements (camera coordinate measurement values) are to be output using actual dimensions. Select the calibration setting method and generate the calibration parameters. <i>1-2-7 Calibration (Camera Image Input FH) on page 1-58</i>

1-2-2 Select Camera (Camera Image Input FH)

When multiple cameras are connected, select the camera to use for measurement.

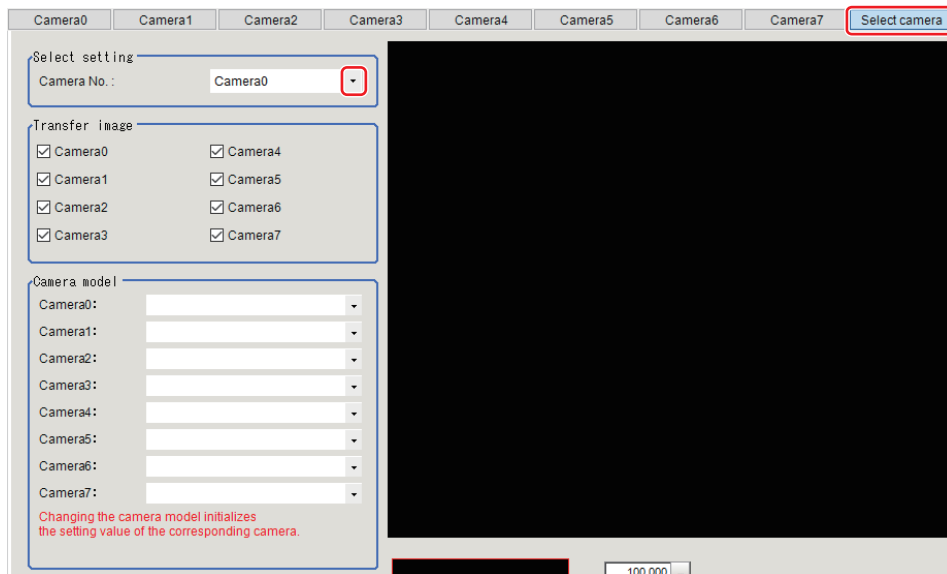

- 1** In the Item Tab area, click **Select camera**.
- 2** Click ▼ on the right of the *Camera No.* and select the camera number.
- 3** If multiple cameras are connected, the camera to transfer images for can be selected. Unchecking checkboxes for cameras not being used for the current Scene or cameras not for the logging target can omit the image transfer processing after those image inputs.



Precautions for Correct Use

Transfer of images for Camera 0 is executed at the same time as image input. Therefore, even if you uncheck the checkbox for Camera 0, the image transfer time is not shortened.

- 4** A camera model currently connected can be checked in the *Camera model* area.



Additional Information

When using the simulation software, you can select any camera model in the *Camera model* area. Changing the camera model will initialize the correspondence camera settings.



Additional Information

The image from the camera selected in *Select camera* will be the object to be measured in the following units.

When you need to switch the camera during the process, insert the *Camera Switching* unit in the scene to switch the image.

For details, refer to *1-9 Camera Switching* on page 1-167.

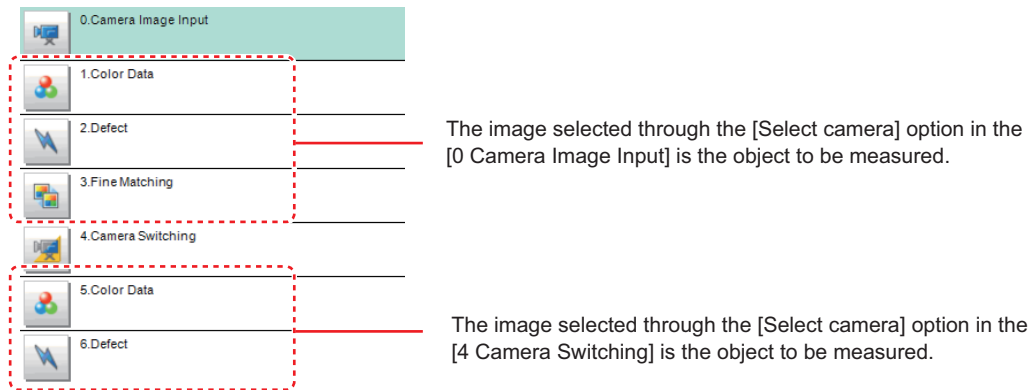

1-2-3 Camera Settings (Camera Image Input FH)

Set the following photographing conditions for each camera.

- *Camera Settings* on page 1-31
- *Binning Settings for Monochrome Cameras only (Not supported by FH-SMX/FH-SMX01/FH-SM21R)* on page 1-37
- *Number of Lines to be Read* on page 1-38
- *Electronic Flash Setting* on page 1-39



Additional Information

The display items differ depending on the camera model and lighting mode. Perform the setting with the following procedures according to the usage environment.

Camera Settings

Adjust the settings related to camera shutter speed and camera gain.

Set the shutter speed appropriate to the speed of the measurement object. Choose a faster shutter speed if the measurement object is moving quickly and the image is blurred.

Adjust the camera gain when images cannot be brightened through the shutter speed, lens aperture, or lighting conditions. Usually, the factory default values can be used.

Example: Using the FZ-SC

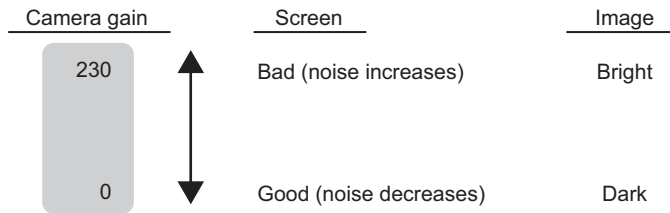

1 In the Item tab area, click **Camera setting**.

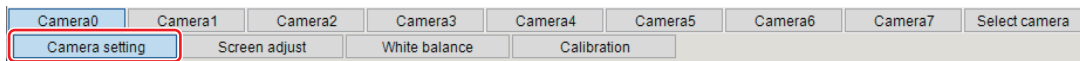

2 In the *Camera settings* area, specify the shutter speed.

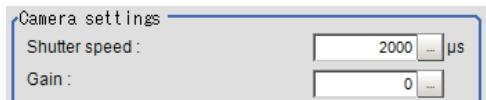

Setting item	Setting value [Factory default]	Description
Shutter speed	FZ-SC/FZ-S/FZ-SHC/FZ-SH 20 to 100,000 [μs] [2,000]	The <i>shutter speed</i> value to set depends on a camera type.
	FZ-SC2M/FZ-S2M/FZ-SC5M □/FZ-S5M □/FZ-SF □/FZ-SP □ 20 to 100,000 [μs] [8,333]	
	FZ-SQ □□□□ 35 to 4,000 [μs] [1,000]	
	FH-SC02/FH-SM02/FH-SC04/FH-SM04 25 to 100,000 [μs] [2,000]	
	FH-SC05R/FH-SM05R 500 to 100,000 [μs] (by 50 μs unit) [8,000]	
	FH-SC12/FH-SM12 60 to 100,000 [μs] [12,000]	
	FH-S □ X/FH-S □ X01/FH-S □ X03/FH-S □ X05/FH-S □ X12 1 to 100,000 [μs] [2,000] *1	
FH-S □ 21R 50 to 100,000 [μs] [2,000] *2		

*1. Note that the shortest shutter speed for FH-S □ X12 is below.
Settable value on the screen: 1 [μs]

Actual shutter speed: 1.5 [μ s]

- *2. When using FH-S □ 21R in the reset mode: the rolling shutter, the actual shutter speed for the setting value on the screen is rounded and reflected in the actual operation.

Note that the reflected operation differs as follows by the number of camera cables and the communication speed setting.

1 camera cable & standard communication speed: Multiple of 46.9 [μ s]

1 camera cable & high communication speed: Multiple of 22.3 [μ s]

2 camera cables & standard communication speed: Multiple of 23.5 [μ s]

2 camera cables & high communication speed: Multiple of 11.2 [μ s]

For example, when the shutter speed is set to 2,000 [μ s], the actual shutter speed is as follows.

1 camera cable & standard communication speed: 1,969.8 [μ s] (42 times of 46.9 [μ s])

1 camera cable & high communication speed: 1,984.7 [μ s] (89 times of 22.3 [μ s])

2 camera cables & standard communication speed: 1,997.5 [μ s] (85 times of 23.5 [μ s])

2 camera cables & high communication speed: 1,993.6 [μ s] (178 times of 11.2 [μ s])

3 Specify the camera gain while checking the image.



Setting item	Setting value [Factory default]	Description
Camera gain	FZ-SC/FZ-S/FZ-SHC/FZ-SH 0 to 230 [85] FZ-SC2M/FZ-S2M/FZ-SC5M □/FZ-S5M □/FZ-SF □/FZ-SP □ 0 to 230 [50] FZ-SC5M3 0 to 230 [65] FZ-SQ □□□□ 16 to 64 [16] FH-SC02/FH-SM02/FH-SC04/FH-SM04 0 to 255 [0] FH-SC12/FH-SM12 0 to 255 [0] FH-SC05R/FH-SM05R 0 to 63 [0] FH-S □ X/FH-S □ X01/FH-S □ X03/FH-S □ X05/FH-S □ X12 0 to 240 [0] FH-S □ 21R 0 to 200 [0]	Adjusts the <i>Camera gain</i> when the shutter speed, the lens aperture, and lighting conditions cannot be used to brighten the image. Usually, the factory default value can be used.



Precautions for Correct Use

- When an Intelligent Compact Digital camera, FZ-SQ□□□□, is connected, we recommend setting the gain value to 16 for stable operations. Measurement values may be different if the recommended value is exceeded.
Be sure to thoroughly check the measurement result and set the gain value.
- Due to the specification of its imaging elements, a CMOS camera generates stripe noises when the gain setting of the camera is raised. You may also find multiple defective pixels, but they do not represent a defect or failure of the product in any way. If stripe noises and defective pixels affect the measurement results, lower the gain setting of the camera or use a CCD camera.
- When performing defect inspection, keep the gain setting at a low value to suppress the influence of image noise.

Reset Mode (FH-SC05R/FH-SM05R/FH-SC21R/FH-SM21R only)

Change the mode when you capture a mobile object.

Reset Mode :

Rolling Shutter

Global Reset

Setting item	Setting value [Factory default]	Description
Reset mode	<ul style="list-style-type: none"> • [Rolling shutter] • Global reset 	Sets the reset mode. <ul style="list-style-type: none"> • Rolling shutter Uses this mode when capturing static objects. Usually, use this setting. • Global reset Uses this mode when capturing moving objects.



Precautions for Correct Use

- FH-SC05R/FH-SM05R/FH-SC21R/FH-SM21R are rolling shutter cameras.
- The exposure start timing and exposure time between lines varies depending on the reset mode setting.

About exposure time of Rolling Shutter for Reset Mode:

- Although the exposure start timing differs between lines, the exposure time length is the same between the lines.
- Since the exposure start timing is different, please control so that the strobe lighting time is from the start of exposure of Line 1 until completion of exposure of Line N.
- The formula for strobe lighting time is that it should be the difference between exposure time + (number of lines -1) x 1 line timing.
- The number of lines depends on the Number of lines to be read setting.
- The timing difference between 1 line varies depending on the binning setting.

FH-S □ 05R

With Binning 1-line setting: 36.375 [μs]

With Binning 2-line setting: 43.583 [μs]

FH-S □ 21R

1 camera cable & standard comm speed setting: 46.8562 [μs]

1 camera cable & high comm speed setting: 22.3399 [μs]

2 camera cables & standard comm speed setting: 23.4556 [μs]

2 camera cables & high comm speed setting: 11.1766 [μs]

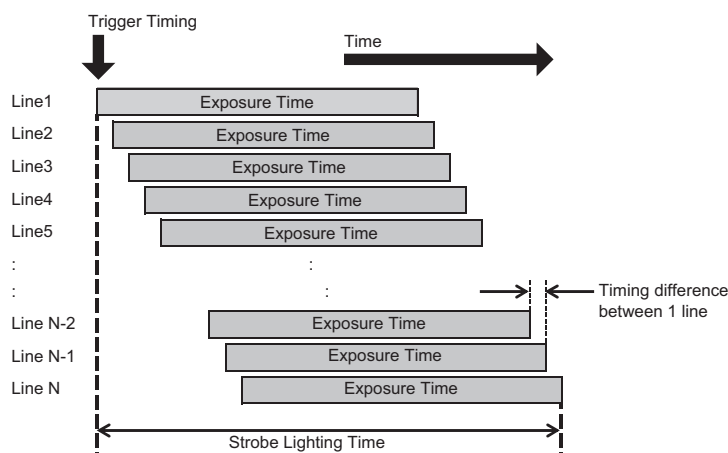

About exposure time of Global Reset for Reset Mode:

- Exposure for all lines starts at the same time, but the exposure time length differs between lines.
- Since the exposure time is different, please control so that the strobe lighting time is from the start of exposure of Line1 until completion of exposure of Line 1.

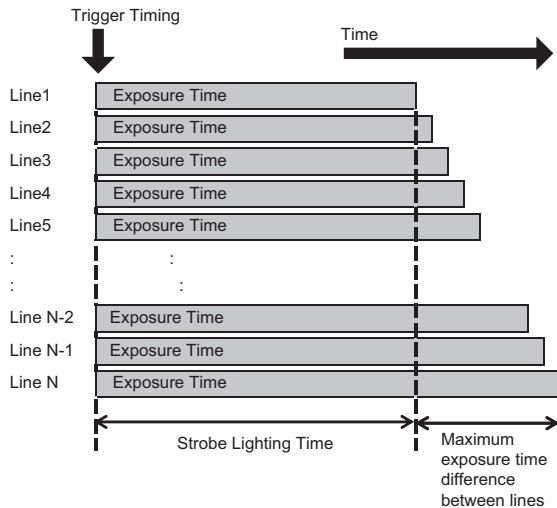

Reverse Conversion (supported by FH-SC□□/ FH-SM□□/ FH-C21R/ FHSM21R. Not supported by FH-SC05R/ FH-SM05R)

Set this option when reversing the camera image vertically or horizontally. The order in which imaging elements are read is changed, so there won't be any delay in image transfer.

- 1 In the Item tab area, click **Camera setting**.

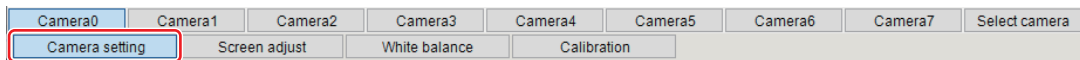

- 2 In the *Camera settings* area, specify the reverse conversion settings.

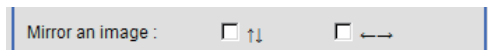

Setting item	Setting value [Factory default]	Description
Mirror an image	↑↓	<ul style="list-style-type: none"> • Checked • [Unchecked] Places a check here when reversing the camera image vertically.
	←→	<ul style="list-style-type: none"> • Checked • [Unchecked] Places a check here when reversing the camera image horizontally.

Setting Multi-slope Function (for Monochrome Cameras of FH-SM□□ Only)

Set this option if you wish to capture a work having a wide dynamic range with a single exposure without causing saturation.

Bright pixels that have reached the charge level specified in the CMOS are clipped and the inclination of stored charge is adjusted, to prevent saturation.

When the multi-slope function is set, pixels that saturate on normal images will no longer saturate. The stored charge amount (inclination of brightness) is changed in the CMOS during a single exposure.

This function can also be set for mobile objects because, unlike with Camera Image Input HDR or Camera Image Input HDR Lite, there is no need to change the exposure time and capture and combine multiple images.

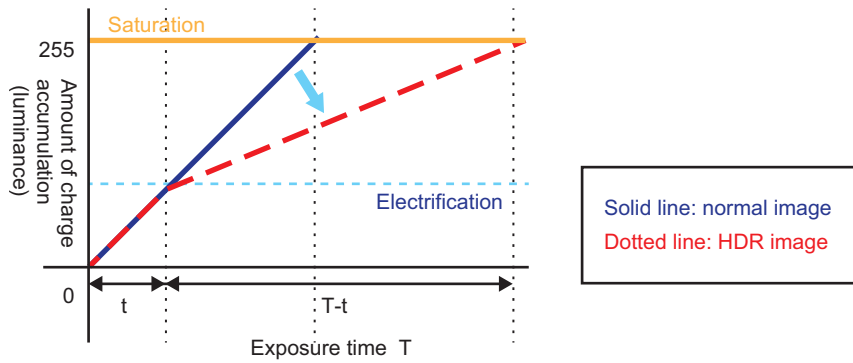

1 In the Item tab area, click **Camera setting**.

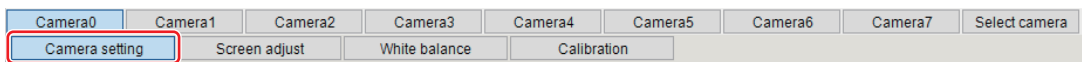

2 In the *Camera settings* area, specify the Multi-slope settings.

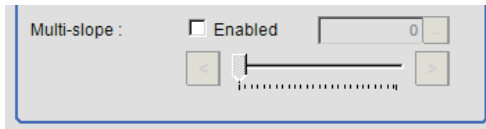

Setting item		Setting value [Factory default]	Description
Multi-slope	Enabled	<ul style="list-style-type: none"> • Checked • [Unchecked] 	Places a check here to use the multi-slope function.
	Slider	-	Sets a new level of the inclination of brightness. When moving the slider to the left, images with wide dynamic range can be supported. The desired level can be set in 255 stages.

Binning Settings for Monochrome Cameras only (Not supported by FH-SMX/FH-SMX01/FH-SM21R)

Binning is a function for obtaining a single value by adding multiple lines together.

Some cameras give the effect of a higher frame rate by raising the sensitivity of the brightness virtually by adding together and decreasing the amount of data to be transferred.



Precautions for Correct Use

The effects that can be obtained with different cameras are as follows.

Camera model	Brightness Sensitivity	Frame rate
FZ-S/FZ-S2M/FZ-S5M3/FZ-SH/FZ-SF/FZ-SP	Effective	Effective
FH-SMX03/FH-SMX05/FH-SMX12	Effective	Effective
FH-SM/FH-SM02/FH-SM04/FH-SM12	Effective	No effect
FH-SM05R	No effect	Effective

1 In the Item tab area, click **Camera setting**.
 In the *Binning settings* area, select either *1 line* or *2 lines*.

Setting item	Setting value [Factory default]	Description
Binning setting	<ul style="list-style-type: none"> [1 line] 2 lines 	<ul style="list-style-type: none"> 1 line Data is transferred line by line. 2 lines Data is transferred two lines at a time. Each image is scanned skipping one scan line per two consecutive lines. Measurement precision is decreased because the image resolution in the vertical direction is lower.

Number of Lines to be Read

By narrowing the image range to be loaded, the image scan time can be shortened.

Set the range taking the offset of the measurement object into consideration.

The part of the image narrowed down by the start line and the end line will be displayed in the setting screen of the processing item window and the Image Display area of the Main screen.

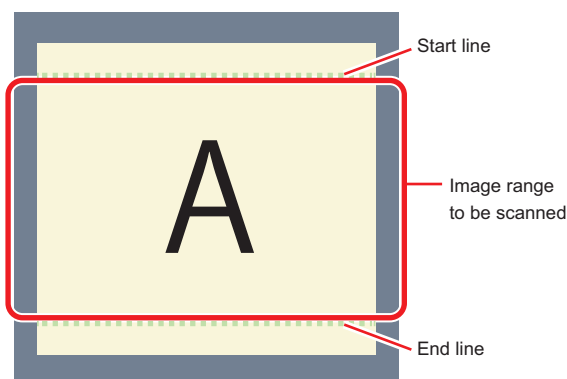

Additional Information

About minimum number of lines:

- With the FH-SM □□/ FH-SMX □□/ FH-SM05R, the minimum number of lines (minimum value between the start and end lines) is 4 line.
- With the FH-SC □□/ FH-SCX □□/ FH-SC05R, the minimum number of lines is 4 lines.
- With the FZ-S □□□ excluding the FZ-SQ series and FZ-S □ 5M3, the minimum number of lines is 12 lines.
- With the FZ-SQ series, the minimum number of lines is 8 lines.
- With the FZ-S □ 5M3, the minimum number of lines is 4 lines.
- For FZ-S □ 5M3, the step width of the Start and End lines is 4 lines. When loading a scene created with the FZ-S □ 5M2, the number of lines loaded will be a maximum of 4 lines.
- With the FH-S □ 21R, the minimum number of lines is 1,848 lines.

About coordinate values:

- The coordinate values displayed as the measurement results are the values of the display position on the monitor.
- The coordinate values do not vary according to the settings for "Number of lines to be read".

- 1 In the Item tab area, click **Camera setting**.

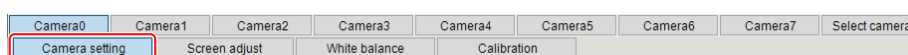

- 2 Set the start and end lines in the *Number of Lines to be Read* area.

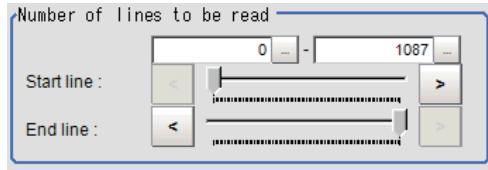

Precautions for Correct Use

- When the built-in lighting of an FZ-SQ□□□□ is used, it may not be possible to shorten the processing time due to restrictions on the light emission time.
- If the following cameras are used with the binning setting set to 2 lines, set the number of capture lines to be a multiple of 8.
FH-SMX03, FH-SMX05, FH-SMX12, FZ-S5M3

Electronic Flash Setting

This function is set when an electronic flash is used. This sets the output conditions for the signal to synchronize the measurement and the electronic flash timing.



Precautions for Correct Use

The setting here applies when *STGOUT* is selected for the output signal in *Common settings* on the *Output signal settings* page of the camera accessed by selecting **Tool - System settings**. When *STGOUT* is selected, the signal is controlled by each setting value of *SHTOUT* for each line.

For details, refer to *Setting the SHTOUT Signal [Output Signal Settings]* in the *Vision System FH/FHV Series User's manual (Cat. No. Z365)*.

- 1 In the Item tab area, click **Camera setting**.

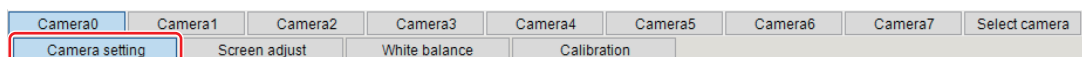

- 2 In the *Electronic flash setting* area, specify each item.

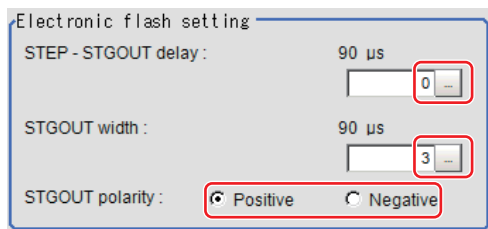

Setting item	Setting value [Factory default]	Description
STEP-STGOUT delay	0 to 511 [0] (1 count: 30 [μs])	Sets the waiting time from the time the start of this camera image input processing item until the electronic flash trigger output signal comes ON. Delay time = Count × 30 μs + 90 μs The delay time varies depending on the <i>polarity of STGOUT pulse</i> . The displayed time is for the positive polarity. Add 35 [μs] to the displayed time when the polarity is negative. The display time becomes within a range of ±10 [μs] to the setting value.
STGOUT width	0 to 43,689 [3] (1 count: 30 [μs])	Sets the output time for the electronic flash trigger signal. If 0 is set, the electronic flash will not flash.
STGOUT polarity	<ul style="list-style-type: none"> • [Positive] • Negative 	Selects the pulse polarity of the electronic flash trigger. <ul style="list-style-type: none"> • Positive polarity Flashes synchronized with the timing of the electronic flash trigger output signal changing from OFF to ON. • Negative polarity Flashes synchronized with the timing of the electronic flash trigger output signal changing from ON to OFF.



Precautions for Correct Use

- Do not perform next camera image input processing before STGOUT signal output is completed. If it were done, STGOUT signal may not be output. Perform camera image input processing after STGOUT signal output is completed or set the STEP-camera delay, STEP-STGOUT delay, and STGOUT pulse width properly so that the electronic flash flashes synchronizing with the exposure time.

1-2-4 Assigning Multiple Electronic Flashes to a Camera

It is possible to assign multiple electronic flashes (STGOUT signals) to a camera and select one to use when an image is taken for measurement. This function uses STGOUT signals with which cameras are not connected. This function can be used only with FH series Sensor Controller. Follow the setting procedure below.



Precautions for Correct Use

- The STGOUT signals that can be output are as follows.
 - FH-2000/FH-5000 series: SGTOUT 0 to 7
 - FH-L series: STGOUT 0 to 3
- STGOUT0 to STGOUT7 is tied to the camera connector number of the sensor controller, not the camera number. When you use CameraLink Medium Configuration or the Multi-line random-trigger mode, confirm the camera connector number that corresponds to the camera number of Sensor Controller.

1 Click **Tool** → **System settings** → **Camera** → **Output signal setting**.

For details, refer to *Setting the SHTOUT Signal [Output Signal Settings]* in the *Vision System FH/FHV Series User's Manual (Cat. No. Z365)*.

2 Select **STGOUT** for **Output Signal** in **Common setting** area.

- 3** Place a check to *Output even if camera is not connected* in *STGOUT setting area*. With this setting, STGOUT signals (STGOUT0 to STGOUT7) which are not connected with cameras can be used. Configure the STGOUT Width of the STGOUT of corresponding Camera Image Input FH Processing Item.

For details, refer to *Electronic Flash Setting* on page 1-39.

Example:

Camera 0 uses STGOUT0 and STGOUT1 and Camera 2 uses STGOUT2.

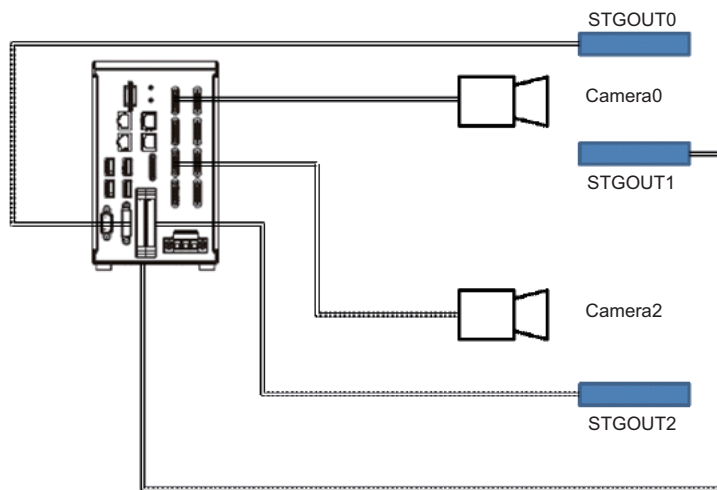

- 4** To use STGOUT0 and STGOUT1 for Camera 0, Camera 1 is not connected with a camera.
- 5** In the *Electronic flash setting* area in the Camera 0 tab of Camera Image Input FH processing item, enter the settings for SGTOU 0.
- 6** In the *Electronic flash setting* area in the Camera 1 tab of Camera Image Input FH processing item, enter the settings for SGTOUT 1.
- 7** In the *Electronic flash setting* area in the Camera 2 tab of Camera Image Input FH processing item, enter the settings for SGTOUT 2.
- 8** In the *Electronic flash setting* area in the Camera 3 to 7 tab of Camera Image Input FH processing item, set 0 to the STGOUT width.



Additional Information

When an electronic flash is not used or it does not flash, enter 0 to the *STGOUT Width*.

1-2-5 Screen Adjustment Settings (Camera Image Input FH)

Set the lighting and lens conditions for each camera.

- *Lighting Control* on page 1-42
- *Line Bright* on page 1-55

Lighting Control

When an Electronic flash controller or Camera-mount Lighting controller is connected, the light volume of the lighting can be adjusted from the Sensor Controller. Moreover, adjusting brightness automatically or selecting one of the preset patterns are also possible.

- 1 In the Item tab area, click **Screen adjust**.

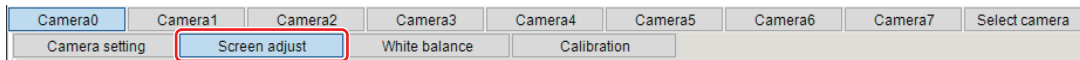

- 2 In the *Lighting control* area, specify the brightness.
Displayed contents vary depending on the connected camera, electronic flash controller, or camera-mount lighting controller.

● Intelligent Compact Digital Camera FZ-SQ □□□□ is connected:

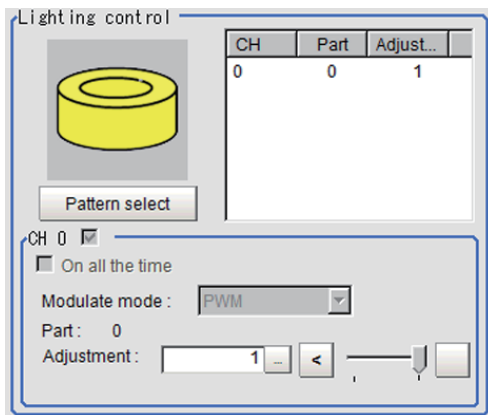

Setting item	Setting value [Factory default]	Description
Pattern select	<ul style="list-style-type: none"> Pattern 0 Pattern 1 	Selects one of the preset lighting patterns. <ul style="list-style-type: none"> Pattern 0: Lit Pattern 1: Unlit
Part	<ul style="list-style-type: none"> 0: Unlit 1: Lit 	Sets the brightness for the selected parts.



Precautions for Correct Use

When the lighting of FZ-SQ □□□□ is used, there are following restrictions.

- The measurement processing time with the lighting on can become longer than that with the lighting off.
- There are restrictions in the operation of Multi-trigger Imaging. For details, refer to *1-11 Multi-trigger Imaging* on page 1-172.

● Camera-mount Lighting Controller FL-TCC1 is Connected:

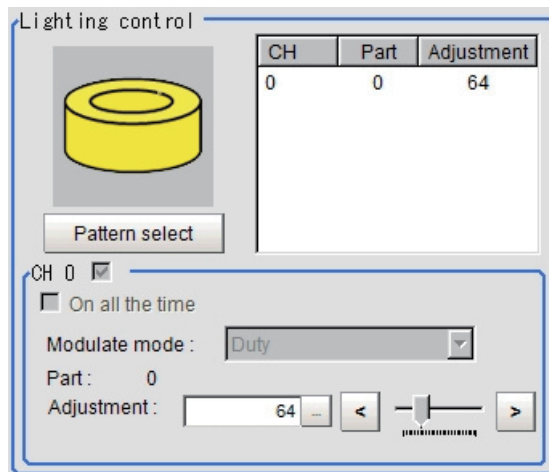

Setting item	Setting value [Factory default]	Description
Pattern select	-	Selects one of the preset lighting patterns.
Part	0 to 255 [64]	Sets the brightness for the selected parts.



Precautions for Correct Use

Per its specifications, the FL-TCC1 cannot emit light longer than 50ms. For that reason, note the following restrictions.

When using Global Reset

- Even if the shutter speed is increased to 50ms or more, it does not become brighter.

When using Rolling Shutter

- When the Reset Mode is set to Rolling Shutter, the lower part of the image will become darker.
- When the Reset Mode is set to Global Reset, even if the shutter speed is increased to 50ms or more, it does not become brighter.

To avoid this restriction, use the FLV-TCC□.

● Camera-mount Lighting Controller FLV-TCC1 is connected:

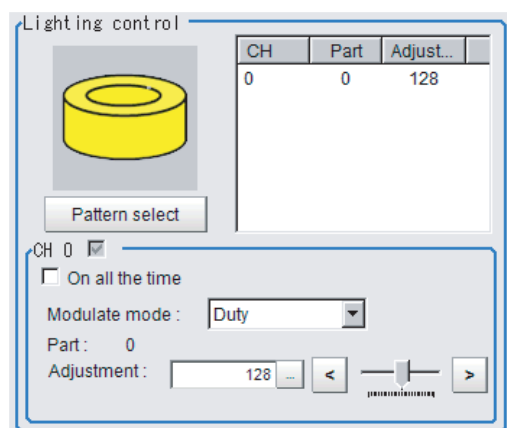

Setting item	Setting value [Factory default]	Description
Pattern select	-	Selects one of the preset lighting patterns.

Setting item	Setting value [Factory default]	Description
On all the time	<ul style="list-style-type: none"> • Checked • [Unchecked] 	Places a check here to keep the lighting turned ON all of the time regardless of the exposure time.
Modulate mode	<ul style="list-style-type: none"> • [Duty] • Voltage/Current 	Selects the lighting adjustment method. <ul style="list-style-type: none"> • Duty The light emitting volume is adjusted with a pulse width of 255 gradation (PWM frequency: 100 kHz). • Voltage/Current The light emitting volume is adjusted with voltage/current levels of 255 gradation. Selects voltage/current adjustment when using this with a high-speed shutter speed.
Part	0 to 255 [128]	Sets the brightness for the selected parts.



Precautions for Correct Use

Per its specifications, the FL-TCC1 cannot emit light longer than 50ms. For that reason, note the following restrictions.

When using Global Reset

- Even if the shutter speed is increased to 50ms or more, it does not become brighter.

When using Rolling Shutter

- When the Reset Mode is set to Rolling Shutter, the lower part of the image will become darker.
- When the Reset Mode is set to Global Reset, even if the shutter speed is increased to 50ms or more, it does not become brighter.

To avoid this restriction, use the FLV-TCC□.

● Camera-mount Lighting Controller FLV-TCC4 is connected:

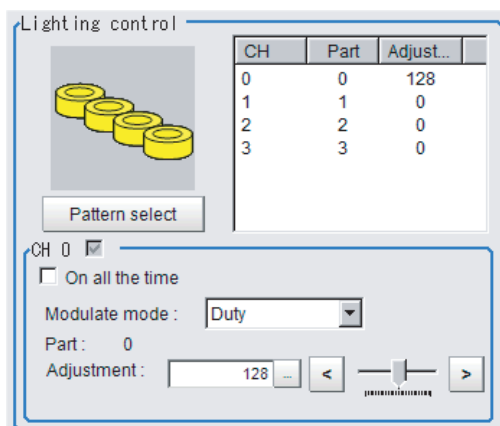

Setting item	Setting value [Factory default]	Description
Pattern select	-	Selects one of the preset lighting patterns.
On all the time	<ul style="list-style-type: none"> • Checked • [Unchecked] 	Places a check here to keep the lighting turned ON all of the time regardless of the exposure time.

Setting item	Setting value [Factory default]	Description
Modulate mode	<ul style="list-style-type: none"> [Duty] Voltage/Current 	<p>Selects the lighting adjustment method.</p> <ul style="list-style-type: none"> Duty The light emitting volume is adjusted with a pulse width of 255 gradation (PWM frequency: 100 kHz). Voltage/Current The light emitting volume is adjusted with voltage/current levels of 255 gradation. <p>Selects voltage/current adjustment when using this with a high-speed shutter speed.</p>
Part	0 to 255 [128]	Sets the brightness for the selected parts.

● **Camera-mount Lighting Controller FLV-TCC1EP is Connected:**

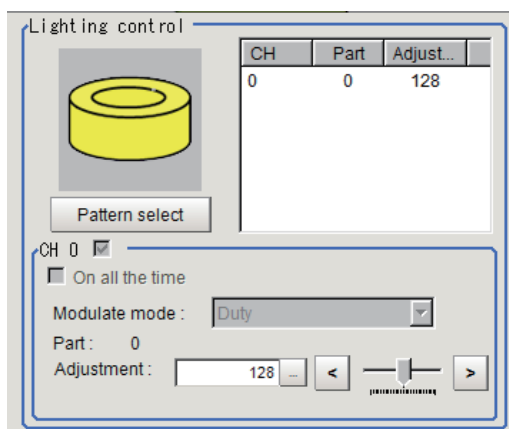

Setting item	Setting value [Factory default]	Description
Pattern select	-	Selects one of the preset lighting patterns.
On all the time	<ul style="list-style-type: none"> Checked [Unchecked] 	Places a check here to keep the lighting turned ON all of the time regardless of the exposure time.
Modulate mode	<ul style="list-style-type: none"> [Duty] Voltage/Current 	<p>Selects the lighting adjustment method.</p> <ul style="list-style-type: none"> Duty The light emitting volume is adjusted with a pulse width of 255 gradation (PWM frequency: 100 kHz). Voltage/Current The light emitting volume is adjusted with voltage/current levels of 255 gradation. <p>Selects voltage/current adjustment when using this with a high-speed shutter speed.</p>
Part	0 to 255 [128]	Sets the brightness for the selected parts.

● Camera-mount Lighting Controller FLV-TCC3HB is connected:

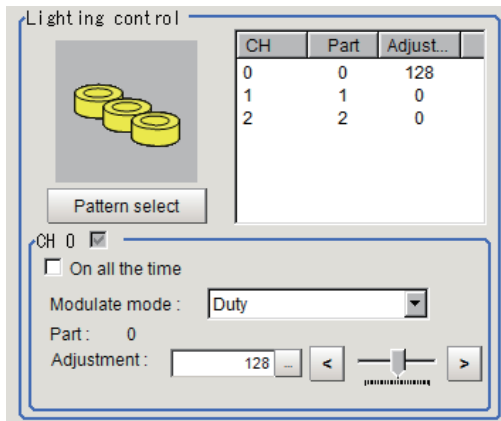

Setting item	Setting value [Factory default]	Description
Pattern select	-	Selects one of the preset lighting patterns.
On all the time	<ul style="list-style-type: none"> Checked [Unchecked] 	Places a check here to keep the lighting turned ON all of the time regardless of the exposure time.
Modulate mode	<ul style="list-style-type: none"> [Duty] Voltage/Current 	Selects the lighting adjustment method. 0ch connected: <ul style="list-style-type: none"> Duty The light emitting volume is adjusted with a pulse width of 255 gradation (PWM frequency: 100 kHz). Voltage/Current The light emitting volume is adjusted with voltage/current levels of 255 gradation. 0ch is for the spotlighting. 1ch / 2ch connected: Selects voltage/current adjustment when using this with a high-speed shutter speed.
Part	0 to 255 [128]	Sets the brightness for the selected parts.

● Camera-mount Lighting Controller FL-TCC1PS is connected:

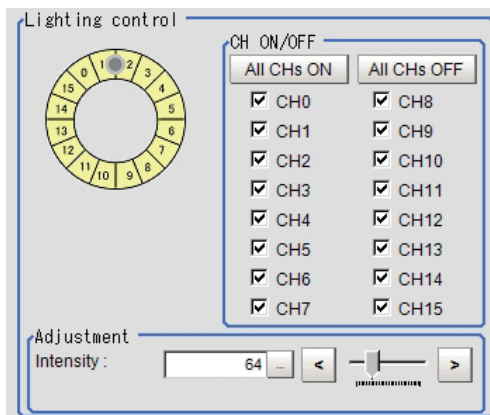

Setting item	Setting value [Factory default]	Description
All CHs ON	-	Sets all channels to ON.
All CHs OFF	-	Sets all channels to OFF.

Setting item	Setting value [Factory default]	Description
CH0 to CH15	<ul style="list-style-type: none"> [Checked] Unchecked 	Sets ON / OFF for each channel.
Intensity	0 to 255 [64]	Sets light intensity.

● Camera-mount Lighting Controller FL-MD □ MC is connected:

Set the lighting direction, lighting colors, and emitting intensity.

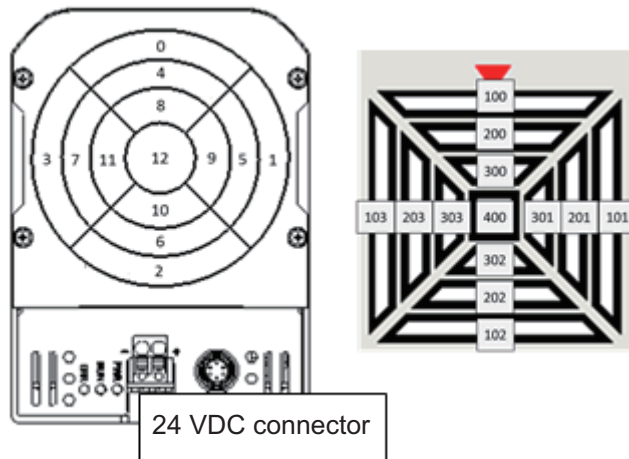

Parts of the lighting controller composed of 13 channels (part: 100 to 103, part: 200 to 203, part: 300 to 303, and part: 400), the emitting intensity in each channel can be specified with RGB and 128 gradations.

Screen Configuration:

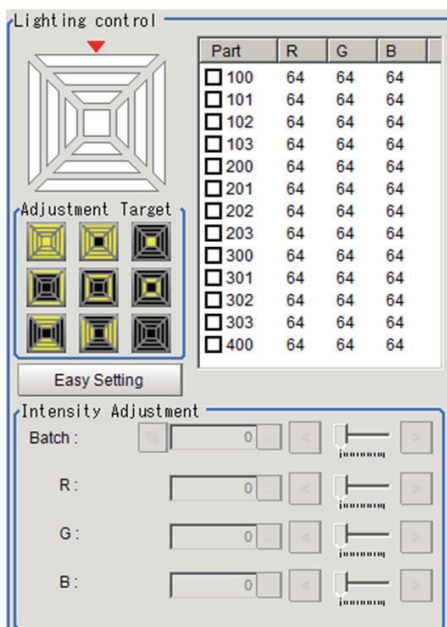

Setting item	Setting value [Factory default]	Description
Schematic diagram	-	Display a number for the part corresponding to the product. The displayed color differs from the emitting lighting color. Combining ON/OFF of R,G,B LEDs illuminates color of red, green, blue, yellow, magenta, cyan, white, gray (all OFF).

Setting item	Setting value [Factory default]	Description
Adjustment target selection	<ul style="list-style-type: none"> All Dome Coaxial Upper Middle Lower Vertical Horizontal [None] 	Select the adjustment target. <ul style="list-style-type: none"> All: All parts Dome: Part 100 to 303 Coaxial: Part 400 Upper: Part 300 to 303 Middle: Part 300 to 203 Lower: Part 100 to 103 Vertical: Part 100, 102, 200, 202, 300, 302 Horizontal: 101, 103, 201, 203, 301, 303 None: Clear all selection
Easy setting button	-	Use this when performing settings according to an application, lighting irradiation pattern, and a condition of the measurement object (defect direction and surface state).
Part selection	<ul style="list-style-type: none"> 100, 101, 102, 103, 200, 201, 202, 203, 300, 301, 302, 303, 400, [Unchecked] 	Select one or more parts to set the emitting intensity of each color. Set the selected parts in the <i>Intensity Adjustment</i> area below.
Intensity Adjustment	0 to 127 [64]	Set the color and light intensity of the selected target. For the selected part, % setting is also available. The time of clicking the % button is the reference.

Setting the Lighting Conditions with “Easy Setting”

The prepared options make the setting easier.

- 1 Click **Easy Setting** on the *lighting control* area.
The following screen is displayed.

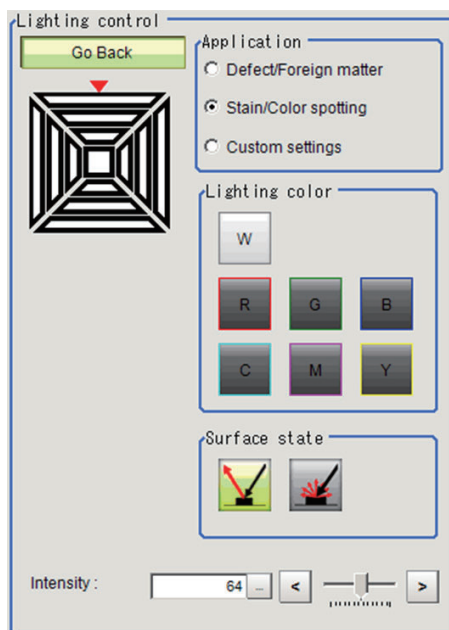

- 2** Set application, lighting colors, and surface conditions.
The displayed items depend on applications.

- Defect/Foreign matter
Select the irradiation angle and defect direction. Adjust the emitting intensity when necessary.

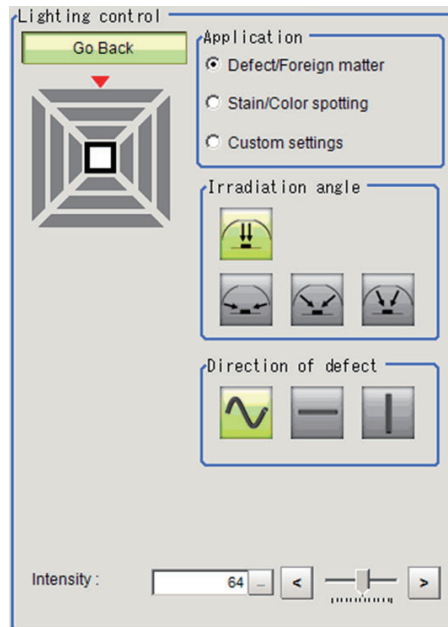

- Stain/Color spotting
Select the lighting color and surface conditions. Adjust the emitting intensity when necessary.

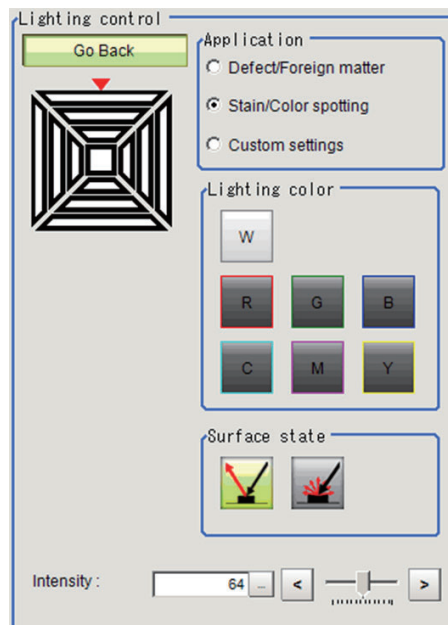

- Custom settings
This screen is displayed when clicking **Easy setting** after detailed settings per each part.

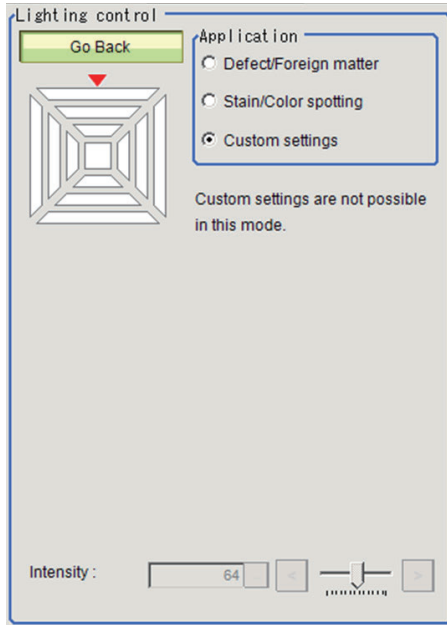

Setting item	Setting value [Factory default]	Description
Application	<ul style="list-style-type: none"> Defect/Foreign matter [Stain/Color spotting] Custom settings 	Select an application. <ul style="list-style-type: none"> Defect/Foreign matter <ul style="list-style-type: none"> Select this to detect unevenness. Specify the irradiation angle and defect direction with the following options. <ul style="list-style-type: none"> Angle: [Coaxial], upper, middle, lower, Direction: [Any], horizontal, vertical Stain/Color spotting: <ul style="list-style-type: none"> Select this to detect color differences. Specify the lighting color and surface state with the following options. <ul style="list-style-type: none"> Color: [W], R, G, B, Y, M, C Surface state: [Specular reflection], diffuse reflection Custom settings: In this screen, the setting is disabled. This becomes a selected state when switched to this screen after detailed settings were done.
Irradiation angle (for Defect/Foreign matter)	<ul style="list-style-type: none"> [Coaxial] Lower Middle Upper 	Select the irradiation angle for lighting. <ul style="list-style-type: none"> Coaxial: Part 400 Lower: Part 100 to 103 Middle: Part 200 to 203 Upper: Part 300 to 303
Direction of defect (for Defect/Foreign matter)	<ul style="list-style-type: none"> [Any] Horizontal Vertical 	Select the direction of a defect to detect.
Lighting color (for Stain/Color spotting)	<ul style="list-style-type: none"> [W] R G B Y M C 	Select the lighting color.

Setting item	Setting value [Factory default]	Description
Surface state (for Stain/color spotting)	<ul style="list-style-type: none"> [Specular reflection] diffuse reflection 	Select the surface state of an object to detect. <ul style="list-style-type: none"> Secular reflection: Part 100 to 303, and 400. Diffuse reflection: Part 100 to 303
Intensity	0 to 127 [64]	Adjust the emitting intensity.

3 Click **Go Back**.

The *Apply Setting* dialog is displayed. Click **OK** to apply the setting. When clicking **Cancel**, then the settings are discarded and return to the Main window.

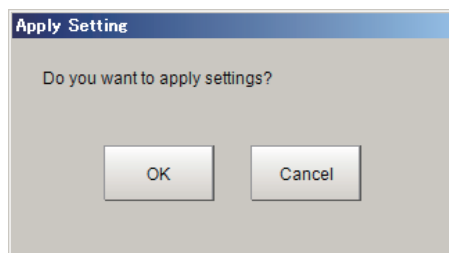

Setting the Lighting Conditions in detail per part

When you want to set the lighting conditions in detail per part, select parts you want to set and adjust the emitting intensity.

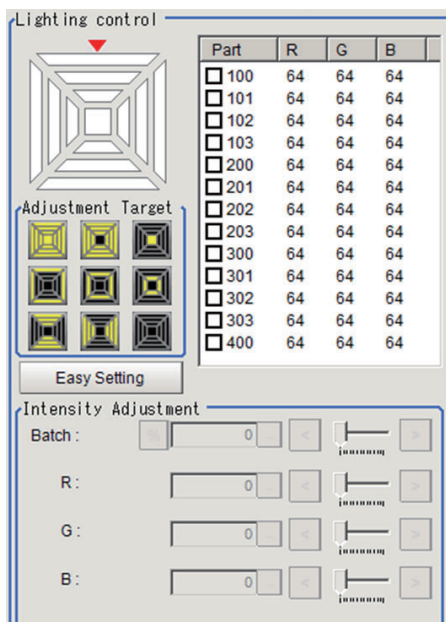

- 1 Place a check to the target part. When adjusting multiple parts at the same time, place a check to them.

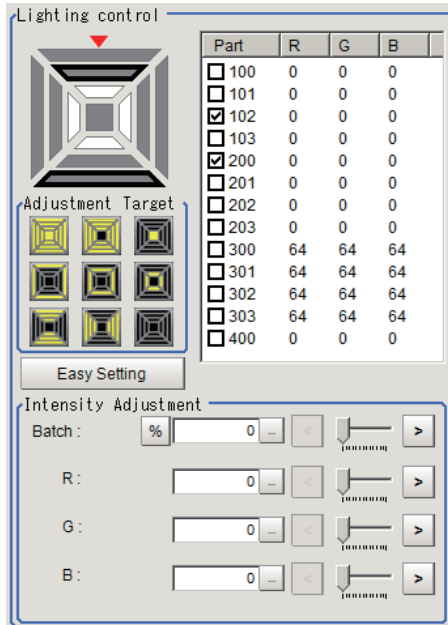

- 2** Adjust the emitting intensity.
 When adjusting all of R, G, B as a batch, use the *Batch*.
 Setting in the unit of percent is also possible.

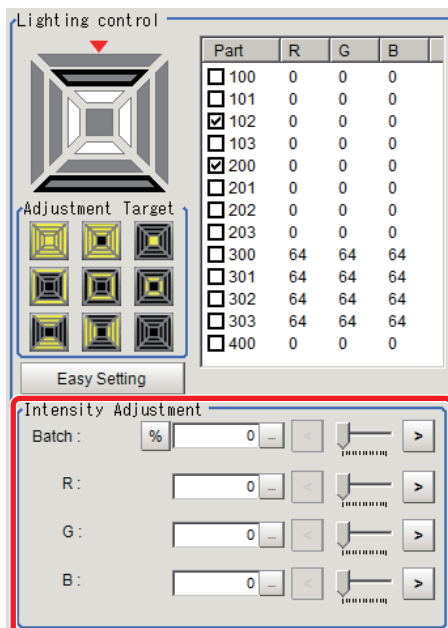



Precautions for Correct Use

- There is no restriction on power consumption nor on emitting mode when using lighting with lighting controller FLV-TCC1EP.
- Restrictions on power consumption and emitting mode vary depending on your product. See the following table for details.

(1) FLV-TCC4/FLV-TCC1

- Without external power supply

Total power consumption	Power consumption per channel	Connectability	Lighting mode*1			READY OFF time delay*1
			Always-on	simultaneous	Single	
Greater than 7.5W	Greater than 7.5W	Not connectable	-	-	-	-
	7.5W or less	Connectable	NA	NA	OK	None
7.5W or less	Less than 7.5W	Connectable	OK	OK	OK	None

- With external power supply

total power consumption	Power consumption per channel	Connectability	Lighting mode*1			READY OFF time delay*1
			Always-on	Simultaneous	Single	
Greater than 15W	Greater than 15W	Not connectable	-	-	-	-
	15W or less	Connectable	NA	NA	OK	Yes
	7.5W or less	Connectable	NA	NA	OK	None
15W or less	Less than 15W	Connectable	NA	OK	OK	Yes
	7.5W or less	Connectable	NA	OK	OK	Yes
7.5W or less	Less than 7.5W	Connectable	OK	OK	OK	None

(2) FLV-TCC3HB

- Without external power supply

0ch (spot lighting) not connected

Total power consumption (1ch/2ch)	Power consumption per channel	Connectability	Lighting mode*1			READY OFF time delay*1
			Always-on	Simultaneous	Single	
Greater than 7.5W	Greater than 7.5W	Not connectable	-	-	-	-
	7.5W or less	Connectable	NA	NA	OK	None
7.5W or less	Less than 7.5W	Connectable	OK	OK	OK	None

0ch (spot lighting) connected:

Total power consumption (1ch/2ch)	Power consumption per channel	Connectability	Lighting mode*1			READY OFF time delay*1
			Always-on	Simultaneous	Single	
Greater than 5.5W	Greater than 7.5W	Not connectable	-	-	-	-
	7.5W or less	Connectable	NA	NA	OK	None
5.5W or less	Less than 5.5W	Connectable	OK	OK	OK	None

- With external power supply

0ch (spot lighting) not connected

Total power consumption (1ch/2ch)	Power consumption per channel	Connectability	Lighting mode*1			READY OFF time delay*1
			Always-on	Simultaneous	Single	
Greater than 15W	Greater than 15W	Not connectable	-	-	-	-
	15W or less	Connectable	NA	NA	OK	Yes
	7.5W or less	Connectable	NA	NA	OK	None
15W or less	Less than 15W	Connectable	NA	OK	OK	Yes
	7.5W or less	Connectable	NA	OK	OK	Yes
7.5W or less	Less than 7.5W	Connectable	OK	OK	OK	None

0ch (spot lighting) connected:

Total power consumption	Power consumption per channel	Connectability	Lighting mode*1			READY OFF time delay*1
			Always-on	Simultaneous	Single	
Greater than 14W	Greater than 15W	Not connectable	-	-	-	-
	15W or less	Connectable	NA	NA	OK	Yes
	7.5W or less	Connectable	NA	NA	OK	None
14W or less	Less than 14W	Connectable	NA	OK	OK	Yes
	7.5W or less	Connectable	NA	OK	OK	Yes
7.5W or less	Less than 7.5W	Connectable	OK	OK	OK	None

*1. • Lighting modes

Always-on lighting mode	The lighting is always turned on by a constant pulse cycle. This mode is enabled when placing a check in the <i>On all the time</i> in the <i>Lighting control</i> area.
-------------------------	--

Simultaneous lighting mode	All lighting connected is synchronously turned on with the trigger. Set the <i>Adjustment</i> in the <i>Lighting control</i> area for each lighting to any value other than 0.
Single lighting mode	Only one lighting is synchronously turned on with the trigger. Set the <i>Adjustment</i> of one part in the <i>Lighting control</i> area to any value other than 0. When two or more channels are set to any value other than 0, the lighting will not be turned on.

- **READY OFF time delay**
The turning OFF time for the READY signal will be delayed for approximately the exposure time compared to no camera-mount lighting controller connected.
(Example) Connection example for connecting an external power supply, and the lighting modes.
 - When four lighting with a power consumption of 1 W each are connected to a camera-mount lighting controller, all lighting modes (Always-on, Simultaneous, and Single) are available.
 - When four lighting with power consumptions of 2W, 3W, 4W, and 5W each are connected to a camera-mount lighting controller, two lighting modes (Simultaneous and Single) are available.
 - When four lighting with power consumptions of 12W, 1W, 2W, and 1W each are connected to a camera mount lighting controller, Single lighting mode is only available.

Line Bright

A graph showing gray distribution for one line in the image is called the *Line bright*. Each line bright corresponding to R, G, B for any line in horizontal and vertical directions is displayed.

- 1 In the Item tab area, click **Screen adjust**.

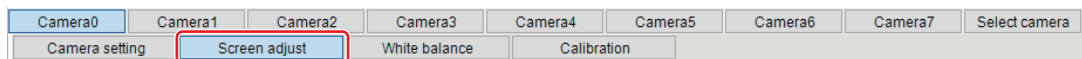

- 2 Place a check to the *Display line bright*.

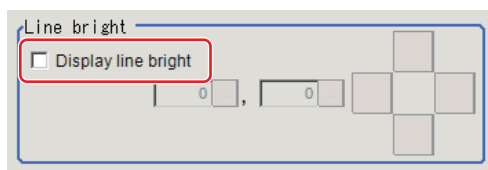

- 3 Move the line to a position whose density distribution is desired to see.

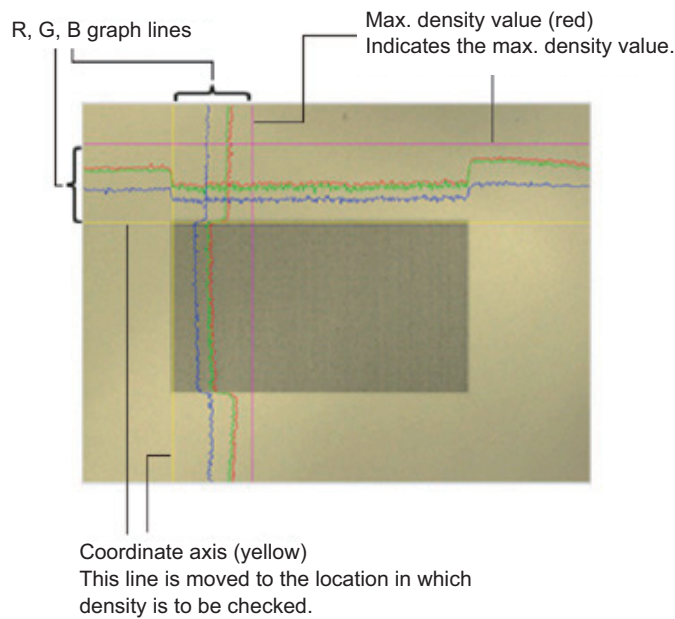

1-2-6 White Balance (Camera Image Input FH)

This feature compensates the color of images loaded from a camera and sets the white balance to make white objects look white.

By adjusting the white balance, proper white color is reproduced with any type of lighting. Moreover, optimum values can also be set automatically.



Additional Information

- The white balance setting is only available when a color camera is used.
- In the following cases, make sure to set the white balance.
 - Newly installed
 - A camera or lighting is changed

Since measurement results may vary with changes in the white balance settings, make sure to verify the operation.

- 1 In the Item tab area, click the **White balance**.

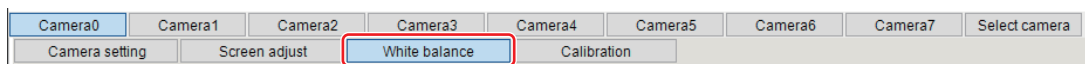

- 2 Shoot a white piece of paper or cloth.
- 3 Click the **Auto**.

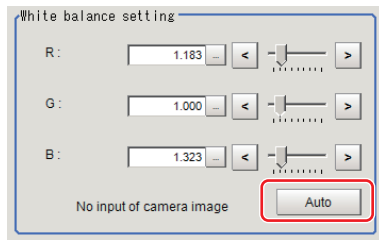

Additional Information

When the *Too bright* or *Too dark* message is displayed, adjust the iris, shutter speed, gain and/or lighting conditions until *Automatic adjustment is possible.* is displayed.

- 4** Set the *R*, *G*, and *B* values as necessary.

Setting item	Setting value [Factory default]	Description
White balance setting	0.001 to 7.999 (R, G, B respectively) (FZ-SQ □□□□ 0.001 to 3.000)	Adjusts the white balance. Whiteness increases when the value of R, G, and B is increased.
• R	FZ-SC	
• G	[R=1.183]	
• B	[G=1.000]	
	[B=1.323]	
	FZ-SC2M	
	[R=1.394]	
	[G=1.000]	
	[B=1.222]	
	FZ-SHC	
	[R=1.375]	
	[G=1.000]	
	[B=1.452]	
	FZ-SFC/FZ-SPC	
	[R=1.145]	
	[G=1.000]	
	[B=1.889]	
	FZ-SC5M2	
	[R=1.351]	
	[G=1.000]	
	[B=2.314]	
	FZ-SC5M3	
	[R=1.400]	
	[G=1.000]	
	[B=2.150]	
	FZ-SQ □□□□	
	[R=1.000]	
	[G=1.040]	
	[B=1.800]	
	FH-SC □□ /FH-SCX □□ /FH-SC21R	
	[R=1.000]	
	[G=1.000]	
	[B=1.000]	
	FH-SC05R	
	[R=1.274]	
	[G=1.000]	
	[B=1.388]	

1-2-7 Calibration (Camera Image Input FH)

By setting the calibration, the measurement result can be converted and output as actual dimensions. The calibration method is selected here.

There are three calibration methods, point, sampling, and parameter.

- *Specifying Points and Setting (Point Specification)* on page 1-59
- *Setting Calibration through Sampling Measurement (Sampling)* on page 1-60
- *Inputting and Setting Values (Value Setting)* on page 1-62
- *View Calibration Parameters* on page 1-63



Additional Information

For outputting measurement values in actual dimensions, select the *Calibration* in the *Output parameter* for each processing unit to *ON*. When the *Calibration* is *OFF* (factory default), then measurement values are output as camera image coordinates.

Specifying Points and Setting (Point Specification)

This is a method for performing calibration by selecting arbitrary points (in pixels).

Calibration parameters are automatically calculated by entering actual coordinates of selected positions. Up to three points are possible to select.

- When the magnification of X and Y directions is the same:
Select two points.

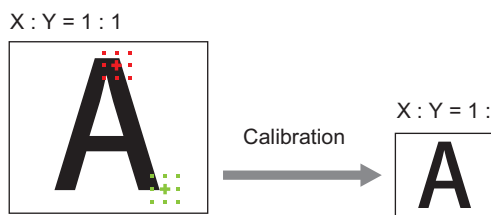

- When the magnification of X and Y directions is not the same:
Select three points.



Additional Information

When two points are selected, the coordinate system is set to the left-handed system (clock-wise). When performing the calibration including the coordinate system, select three points.

- 1 In the Item tab area, click the **Calibration**

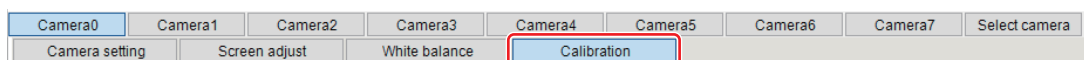

- 2 In the Calibration setting area, select the *Specify point*.

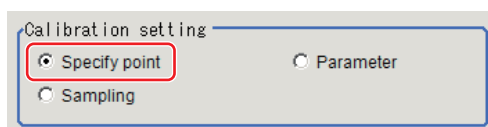

- 3 Click the first point on the screen.
- 4 Set the actual coordinates for the specified point.

The actual coordinate input window is displayed.

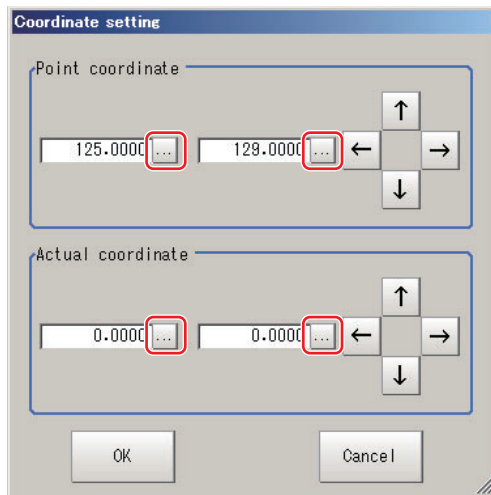

Setting item	Setting value [Factory default]	Description
Point coordinate X, Y	0 to 9,999.9999 [Point clicked in the window]	-
Actual coordinate X, Y	-99,999.9999 to 99,999.9999 [0]	-

- 5** Set the second and third points in the same way.
- 6** Click the **Generate calibration parameters**.
The calibration parameters will be generated.

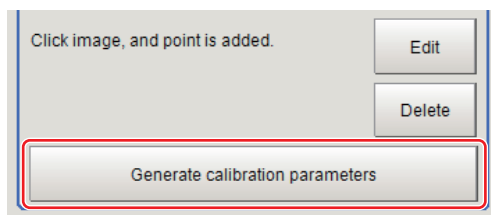

Setting Calibration through Sampling Measurement (Sampling)

This is a method for setting calibration based on measurement results.

Calibration parameters are automatically calculated by searching a registered model and setting the actual coordinate of the position.

- 1** In the Item tab area, click the **Calibration**

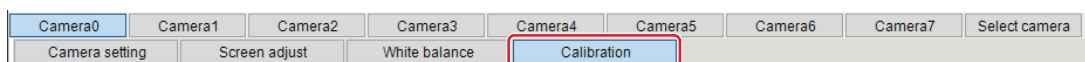

- 2** In the *Calibration setting* area, select the *Sampling*.

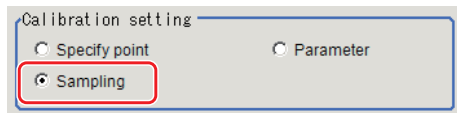

- 3** In the *Sampling* area, click the **Register model**.

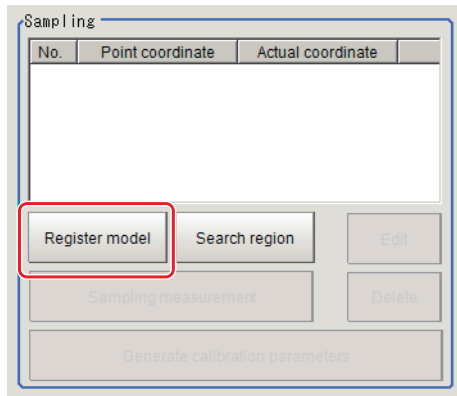

- 4** Register the model with the Drawing tools.

- 5** Set a search region as necessary.
The initial value is the entire screen.

- 6** Click **Sampling measurement**.
Measurement is performed.
The search result (crosshair cursor) is displayed in the *Image Display* area and the *Sampling Coordinate* window is displayed.

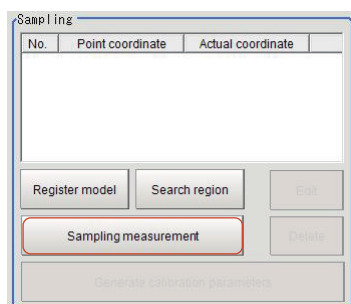

- 7** In the *Sampling Coordinate* window, set the X and Y values.

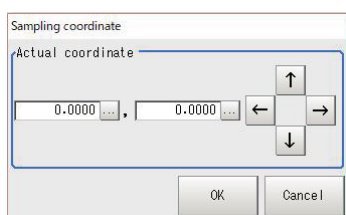

- 8** Click **OK**
The point coordinates and actual coordinates are registered in the *Sampling* area.

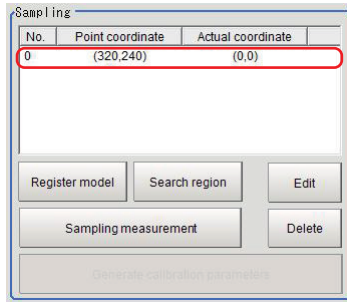

9 Move the measurement object and repeat the step 3 to 8.

10 Click the **Generate calibration parameters**.
The calibration parameters will be generated.



Inputting and Setting Values (Value Setting)

Set calibration data directly with numerical values.

1 In the Item tab area, click the **Calibration**

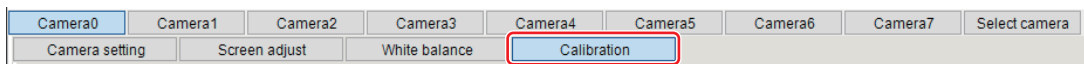

2 In the *Calibration setting* area, select the *Parameter*.

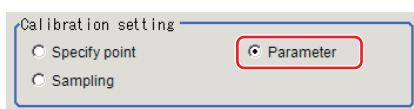

3 In the *Parameter* area, specify values for *Coordinate*, *Origin*, *Magnification*.

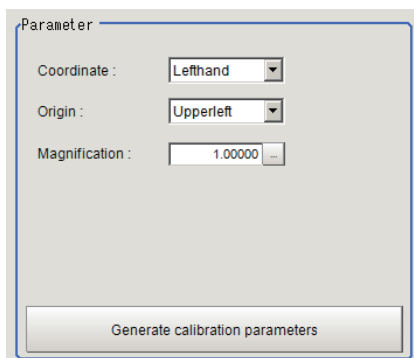

Setting item	Setting value [Factory default]	Description
Coordinate	<ul style="list-style-type: none"> [Lefthand] Righthand 	<ul style="list-style-type: none"> Lefthand The clockwise is forward when setting the coordinates. Righthand The counter-clockwise is forward when setting the coordinates.
Origin	<ul style="list-style-type: none"> [Upper left] Lower left Center 	<p>Sets the origin of the actual coordinates.</p>
Magnification	0.00001 to 9.99999	Specifies the ratio of one pixel to the actual dimensions.

- Click the **Generate calibration parameters**.
The calibration parameters will be generated.

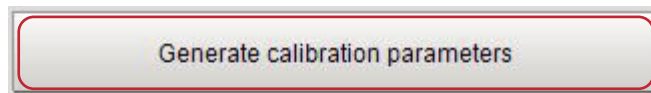

View Calibration Parameters

View the set calibration data.

- In the Item tab area, click the **Calibration**

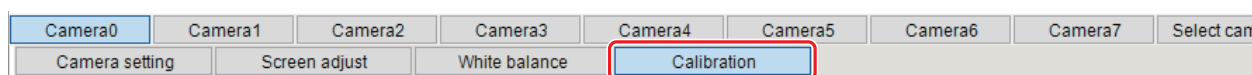

- In the *Calibration parameter* area, confirm the calibration data.

Calibration parameter			
A:	1.000000	D:	0.000000
B:	0.000000	E:	1.000000
C:	0.000000	F:	0.000000
Field of view :	640.000000		

Setting item	Setting value	Description
A	Calculation value	These are calibration conversion values. Camera coordinates are converted to actual coordinates based on these values. The conversion formulas for actual coordinates are as follows: (X, Y): Measurement point (camera coordinates), Unit: pixel (X', Y'): Conversion point (actual coordinates) $X' = A \times X + B \times Y + C$ $Y' = D \times X + E \times Y + F$
B	Calculation value	
C	Calculation value	
D	Calculation value	
E	Calculation value	
F	Calculation value	
Field of view	Calculation value	An actual dimension in the X direction.

1-2-8 External Reference Tables (Camera Image Input FH)

No.	Data name	Data ident	Set/Get	Data range
None	Judge	judge	Get only	0: No judgment (unmeasured), 1: Judgment result OK, -1: Judgment result NG, -10: Error (image format mismatch), -11: Error (unregistered model), -12: Error (insufficient memory), -20: Error (other errors)
None	Lighting control(Site List)	lightGain	Set/Get	A representation of a lighting brightness of each Part in hexadecimal. A value of Part 0 to Part 7 is presented from left to right. Example: When the illumination brightness of Part 0 to Part 3 was set to 255 (ff): ffffffff00000000
None	Modulate mode	lightGainMode	Set/Get	It represents the dimming method for each Part with the sum of 4-bit units. 0: Duty, 1: Voltage and Current. Example: When Part 0, Part 2, and Part 5 are set to Voltage and Current: 1048833
None	CH	lightEnabledChannel	Set/Get	0: OFF, 1: ON
None	STEP - STGOUT delay	strobeDelay	Set/Get	
None	STGOUT width	pulseWidth	Set/Get	
None	STGOUT polarity	pulsePolarity	Set/Get	0: Negative, 1: Positive
None	On all the time	alwaysLight	Set/Get	0: OFF, 1: ON
None	White balance	whiteBalance	Set/Get	R G B

No.	Data name	Data ident	Set/Get	Data range
None	Calibration parameter	calibParameter	Set/Get	A B C D E F separated by ","
None	Zoom	zoom	Set/Get	
None	Focus	focus	Set/Get	
None	Iris	iris	Set/Get	
None	End line	endY	Set/Get	
None	Camera model	cameraModel	Set/Get	Connectable camera model name
None	Shutter speed	exposureTime	Set/Get	
None	Gain	gain	Set/Get	
None	Camera No.	cameraNo	Set/Get	
None	Transfer image	cameraMask	Set/Get	Bit sum of cameras not to be transferred. 1: Camera0, 2: Camera1, 4: Camera2, 8: Camera3, 16: Camera4, 32: Camera5, 64: Camera6, 128: Camera7
None	Iris base density	irisDensity	Set/Get	
None	Mirror an image(↑↓)	reverseY	Set/Get	0: OFF, 1: ON
None	Reset Mode	shutterResetMode	Set/Get	0: Rolling Shutter, 1: Global Reset
None	Binning setting	binningY	Set/Get	0: One line, 1: Two line
None	Start line	startY	Set/Get	
None	Mirror an image(←→)	reverseX	Set/Get	0: OFF, 1: ON
None	Multi-slope(Enabled)	multiSlopeMode	Set/Get	0: OFF, 1: ON
None	Multi-slope(slider)	multiSlopeKneePoint	Set/Get	

1-3 Camera Image Input FHV

This processing item is specialized for the FHV Sensor Controller.

Set the conditions for loading images from the camera and for storing images of the measured objects. This processing item must be used when measuring.

It is possible to capture images whose shutter speed or lighting differ by setting multiple *Camera Image input FHV* to your measurement flow.

Used in the Following Case

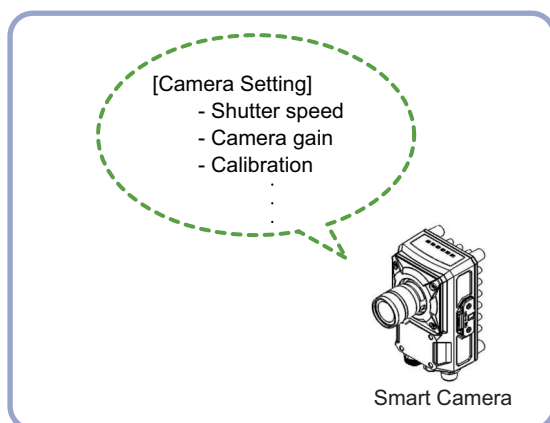

Precautions for Correct Use

- *Camera Image Input FHV* is preset for Unit 0. Set only a Camera Image Input processing item related to FHV to Unit 0.
 - When switching from a color camera to a monochrome camera or switching to a camera with a different resolution, reset the following units.
 - If a camera model is different from the previous one, the camera settings are returned to the initial ones. As same as the camera settings, a lighting and/or lens model is different from the previous one, the settings are also returned to the initial ones.
 - For this processing item, do not use scene variables or system-defined variables as parameters.
 - Just after starting up the Sensor Controller or just after changing scenes, it becomes no image input. In this state, it is set to the same color image processing as in the factory default state.
 - When the *Properties* dialog box is opened with no image input, click the **Cancel** button to close the dialog box. Pressing the **OK** button in the dialog box will change the setting to the same color camera setting as the factory default state.
- For details, *FAQ - For Measurement - The measurement NG (image mismatch) error will result when connecting a monochrome camera in the Vision System FH/FHV Series User's Manual* (Cat. No. Z365).

1-3-1 Settings Flow (Camera Image Input FHV)

To set Camera Image Input FHV, follow the steps below.

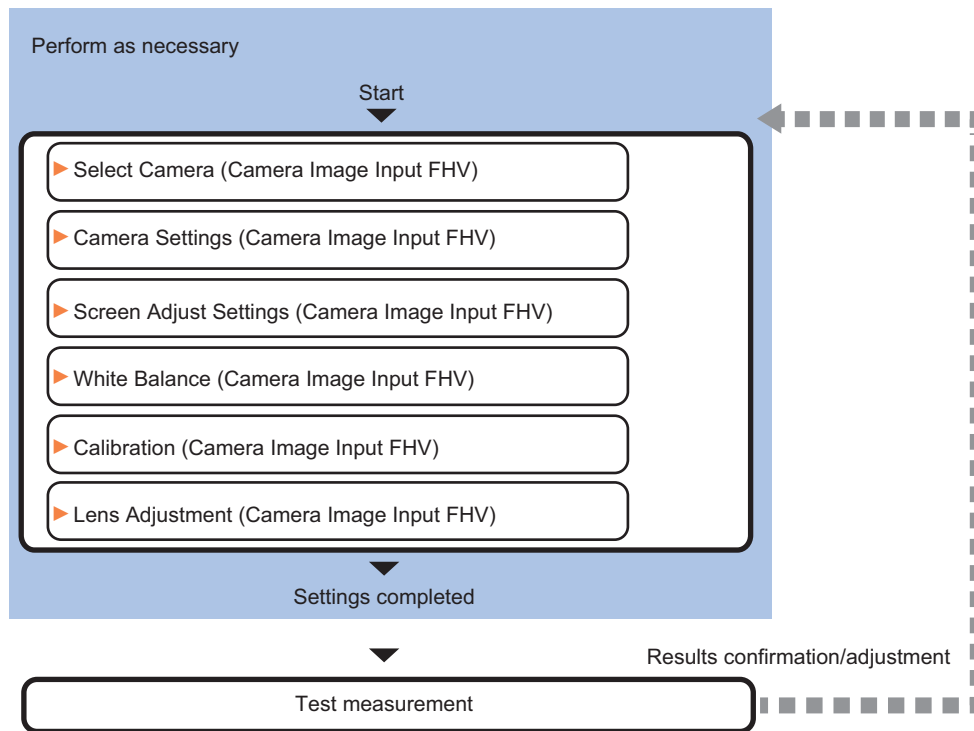

List of Camera Image Input FHV Items

Item	Description
Select camera	Check the type of camera, lighting, and lens that are currently connect- ed. <i>1-3-2 Camera Selection (Camera Image Input FHV)</i> on page 1-68
Camera settings	Specify the camera settings such as the shutter speed or electronic flash. <i>1-3-3 Camera Settings (Camera Image Input FHV)</i> on page 1-68
Screen adjust	Set the lighting conditions. <i>1-3-4 Screen Adjustment Settings (Camera Image Input FHV)</i> on page 1-75
White balance	When using a color camera, adjust the white balance. <i>1-3-5 White Balance (Camera Image Input FHV)</i> on page 1-82
Calibration	Set when measurements (camera coordinate measurement values) are to be out- put using actual dimensions. Select the calibration setting method and generate the calibration parameters. <i>1-3-6 Calibration (Camera Image Input FHV)</i> on page 1-83
Lens adjustment	Adjust the lens focus. <i>1-3-7 Lens Adjustment (Camera Image Input FHV)</i> on page 1-89

1-3-2 Camera Selection (Camera Image Input FHV)

Check the model of camera, lighting, and lens that are currently connected.

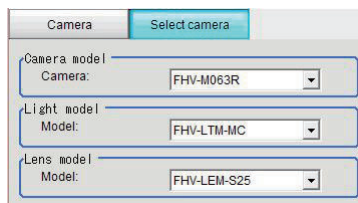

The screenshot shows a software interface for camera selection. At the top, there is a tab labeled 'Camera' and a button labeled 'Select camera'. Below this, there are three sections, each with a label and a dropdown menu:

- Camera model:** The dropdown menu is set to 'FHV-M063R'.
- Light model:** The dropdown menu is set to 'FHV-LTM-MC'.
- Lens model:** The dropdown menu is set to 'FHV-LEM-S25'.

- 1** In the Item tab area, Click **Select camera**.
- 2** In the *Camera model* area, you can check the camera model that is currently connected.
- 3** In the *Light model* area, you can check the lighting model that is currently connected.
- 4** In the *Lens model* area, you can check the lens model that is currently connected.



Additional Information

When using the simulation software, you can select any model in the *Camera model*, *Light model*, and *Lens model* areas. When the model is changed, the corresponding settings are initialized.

1-3-3 Camera Settings (Camera Image Input FHV)

Set the following photographing conditions to the camera.

- *Camera Settings* on page 1-68
- *Binning Settings (for Monochrome Camera - FHV□□-M0016□□□□ Only)* on page 1-73
- *Number of Lines to be Read* on page 1-73
- *Electronic Flash Settings* on page 1-74



Additional Information

The display items differ depending on the camera model and lighting mode. Perform the setting with the following procedures according to the usage environment.

Camera Settings

Adjust the settings related to camera shutter speed and camera gain.

Set the shutter speed appropriate to the speed of the measurement object. Choose a faster shutter speed if the measurement object is moving quickly and the image is blurred.

Adjust the camera gain when images cannot be brightened through the shutter speed, lens aperture, or lighting conditions. Usually, the factory default values can be used.

Example:

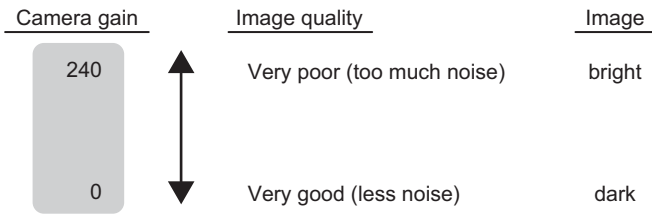

1 In the Item tab area, click **Camera setting**.

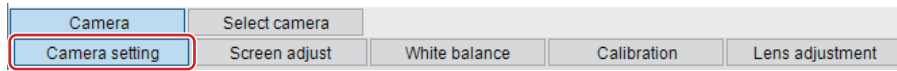

2 In the *Camera settings* area, specify the shutter speed.

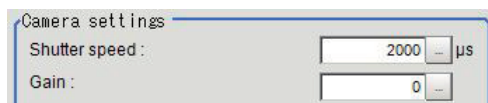

Setting item	Setting value [Factory default]	Description
Shutter speed	FHV7□-M004□/FHV7□-M008□/ FHV7□-M016□/FHV7□-M032□/ FHV7□-M050□/FHV7□-C004□/ FHV7□-C008□/FHV7□-C016□/ FHV7□-C032□/FHV7□-C050□ 1 to 100,000 [μs] [2,000] FHV7□-M063R□/FHV7□-C063R□ 55 to 100,000 [μs] [2,000] *1 FHV7□-M120R□/FHV7□-C120R□ 84 to 100,000 [μs] [2,000] *1	The <i>Shutter speed</i> option varies depending on the camera model.

*1. Note that the shutter speed for FHV7□-M063R□/FHV7□-M120R□/FHV7□-C063R□/FHV7□-C120R□ is below.
 Settable value on the screen: 1 [μs] step
 Actual shutter speed: 7.79 [μs] step
 The setting value on the screen is converted in the camera to a close value to it and reflected in the actual operation.

3 Specify the camera gain while checking the image.



Setting item	Setting value [Factory default]	Description
Gain	FHV7□-M004□/FHV7□-M008□/ FHV7□-M016□/FHV7□-M032□/ FHV7□-M050□/FHV7□-C004□/ FHV7□-C008□/FHV7□-C016□/ FHV7□-C032□/FHV7□-C050□ 0 to 240 [0] FHV7□-M063R□/FHV7□-M120R□/ FHV7□-C063R□/FHV7□-C120R□ 0 to 180 [0]	Adjust the <i>camera gain</i> when the shutter speed, the lens aperture, and lighting conditions cannot be used to brighten the image. Usually, the factory default value can be used.



Precautions for Correct Use

- Due to the specification of its imaging elements, a CMOS camera generates stripe noises when the gain setting of the camera is raised. You may also find multiple defective pixels, but they do not represent a defect or failure of the product in any way. If stripe noises and defective pixels affect the measurement results, lower the gain setting of the camera.
- When performing defect inspection, keep the gain setting at a low value to suppress the influence of image noise.

Reverse Conversion

Set this option when reversing the camera image vertically or horizontally. Changing the order to read out from the imaging elements will not cause any delay in image transfer.

- 1 In the Item tab area, click **Camera setting**.

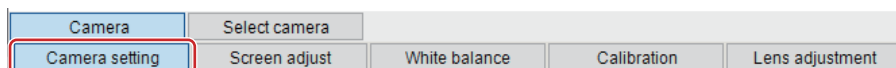

- 2 In the *Camera settings* area, specify the reverse conversion settings.



Setting item	Setting value [Factory default]	Description
Mirror an image	↑↓	• Checked • [Unchecked]
	← →	• Checked • [Unchecked]

Reset Mode (for FHV7□-M063R□/FHV7□-C063R□/FHV7□-M120R□/ FHV7□-C120R□ only)

This mode is used to capture moving objects.



Setting item	Setting value [Factory default]	Description
Reset mode	<ul style="list-style-type: none">• [Rolling shutter]• Global reset	<p>Sets the reset mode.</p> <ul style="list-style-type: none">• Rolling shutter Uses this mode when capturing static objects. Usually, use this setting.• Global reset Uses this mode when capturing moving objects.



Precautions for Correct Use

- FHV7□-M063R□/ FHV7□-C063R□/ FHV7□-M120R□/ FHV7□-C120R□ are the rolling shutter cameras.
- The exposure timing and exposure time between lines varies depending on the reset mode setting.

About Exposure Time of Rolling Shutter for Reset Mode:

- Although the exposure start timing varies between lines, the exposure time length is the same between lines.
- As the exposure start timing differs, control the strobe lighting time from the start of exposure of Line 1 to the completion of the exposure of Line N.
- The rough estimation for the strobe lighting time is the difference between the exposure time + (the number of lines - 1) x 1 line timing.
- The number of lines depends on the number of lines to be read setting.

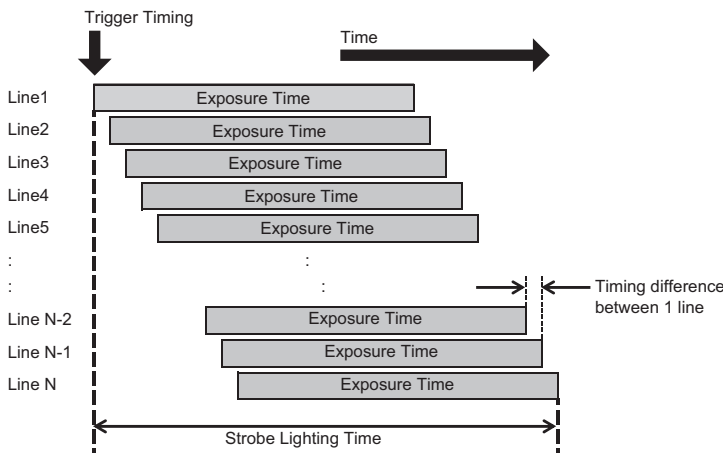

About Exposure Time of Global Reset for Reset Mode:

- Although exposure for all lines starts at the same time, the exposure time length varies between lines.
- As the exposure time differs, control the strobe lighting time from the start of exposure of Line 1 to the completion of the exposure of Line 1.

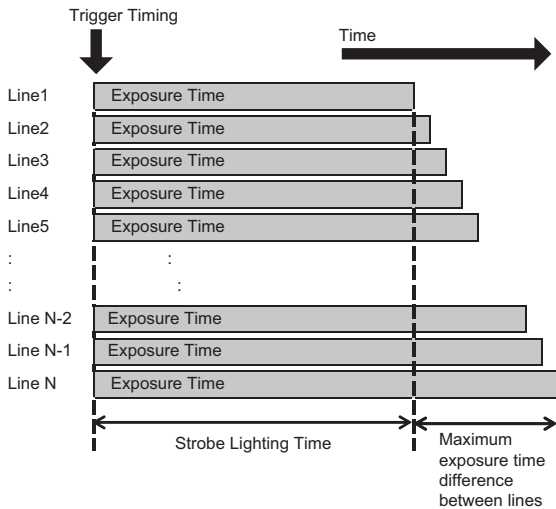

Binning Settings (for Monochrome Camera - FHV□□-M0016□□□ Only)

Binning is a function for obtaining a single value by adding multiple lines together.

In some case, this gives the effect of virtually raising the sensitivity of the brightness by combining multiple lines and another case the effect of increasing the frame rate by decreasing the amount of data to be transferred.

- 1 In the Item tab area, click **Camera setting**.
In the *Binning settings* area, select either *1 line* or *2 lines*.

Setting item	Setting value [Factory default]	Description
Binning setting	<ul style="list-style-type: none"> • [1 line] • 2 lines 	<ul style="list-style-type: none"> • 1 line Data is transferred line by line. • 2 lines Data is transferred two lines at a time. Each image is scanned skipping one scan line per two consecutive lines. Measurement precision is decreased because the image resolution in the vertical direction is lower.

Number of Lines to be Read

By narrowing the image range to be loaded, the image scan time can be shortened.

Set the range taking the offset of the measurement object into consideration.

The part of the image narrowed down by the start line and the end line will be displayed in the setting screen of the processing item window and the Image Display area of the Main screen.

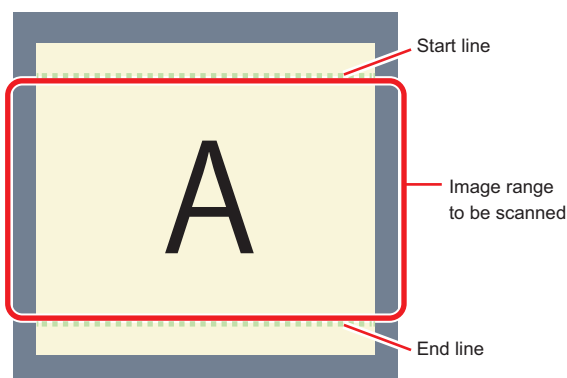



Additional Information

About the minimum number of lines:

- For FHV7□-M004□/FHV7□-M008□/FHV7□-M016□/FHV7□-M032□/FHV7□-M050□/ FHV7□-C004□/ FHV7□-C008□/ FHV7□-C016□/ FHV7□-C032□/ FHV7□-C050□, the minimum number of lines (minimum value between the start and end lines) is 3 lines.
- For FHV7□-M063R□/FHV7□-M120R□/FHV7□-C063R□/FHV7□-C120R□, the minimum number of lines is 3 lines.
- The step width from the start to end lines is 4 lines.

About coordinate values:

- The coordinate values of the measurement results are the display position values on the monitor.
- The coordinate values will not vary with this setting.

- 1 In the Item tab area, click **Camera setting**.

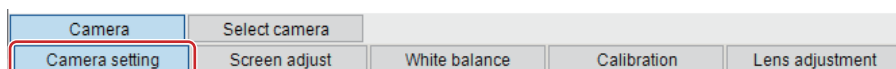

- 2 Set the start and end lines in the *Number of Lines to be Read* area.

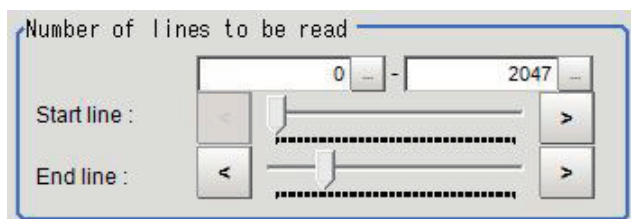

Precautions for Correct Use

When FHV7□-M063R□/FHV7□-M120R□/FHV7□-C063R□/FHV7□-C120R□ is used, the processing time may not be shortened.

Electronic Flash Settings

This function is set when an electronic flash is used. This sets the output conditions for the signal to synchronize the measurement and the electronic flash timing.



Precautions for Correct Use

The setting here applies when *STGOUT* is selected for the output signal in *Common settings* on the *Output signal settings* page of the camera accessed by selecting **Tool - System settings**. When *STGOUT* is selected, the signal is controlled by each setting value of *SHTOUT* for each line.

For details, refer to *Setting the SHTOUT Signal [Output Signal Settings]* in the *Vision System FH/FHV Series User's manual (Cat. No. Z365)*.

- 1 In the Item tab area, click **Camera setting**.

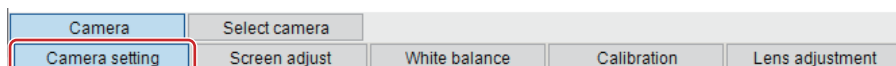

- 2 In the *Electronic flash setting* area, specify each item.

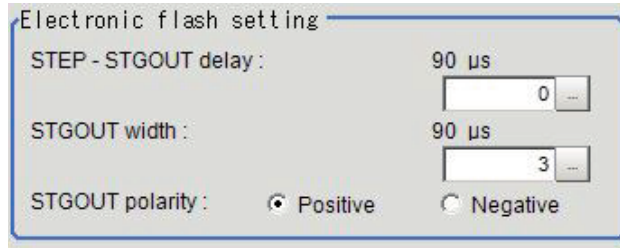

Setting item	Setting value [Factory default]	Description
STEP-STGOUT delay	0 to 511 [0] (1 count: 30 [μs])	Sets the waiting time from the time the start of this camera image input processing item until the electronic flash trigger output signal comes ON. Delay time = Count × 30 μs + 90 μs The delay time varies depending on the <i>polarity of STGOUT pulse</i> . The displayed time is for the positive polarity. Add 35 [μs] to the displayed time when the polarity is negative. The display time becomes within a range of ±10 [μs] to the setting value.
STGOUT width	0 to 43,689 [3] (1 count: 30 [μs])	Sets the output time for the electronic flash trigger signal. If 0 is set, the electronic flash will not flash.
STGOUT polarity	<ul style="list-style-type: none"> [Positive] Negative 	Selects the pulse polarity of the electronic flash trigger. <ul style="list-style-type: none"> Positive polarity Flashes synchronized with the timing of the electronic flash trigger output signal changing from OFF to ON. Negative polarity Flashes synchronized with the timing of the electronic flash trigger output signal changing from ON to OFF.



Precautions for Correct Use

- Do not perform next camera image input processing before STGOUT signal output is completed. If it were done, STGOUT signal may not be output. Perform camera image input processing after STGOUT signal output is completed or set the STEP-camera delay, STEP-STGOUT delay, and STGOUT pulse width properly so that the electronic flash flashes synchronizing with the exposure time.

1-3-4 Screen Adjustment Settings (Camera Image Input FHV)

Set the lighting and lens conditions for each camera.

- Lighting Control* on page 1-75
- Line Bright* on page 1-81

Lighting Control

When an Electronic flash controller or Camera-mount Lighting controller is connected, the light volume of the lighting can be adjusted from the Sensor Controller. Moreover, adjusting brightness automatically or selecting one of the preset patterns are also possible.

- 1 In the Item tab area, click **Screen adjust**.

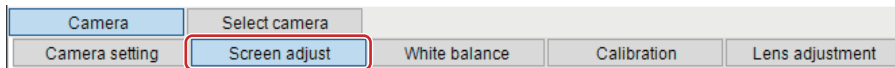

- 2 In the *Lighting selection* area, select a model of lighting to be used.

Setting item	Setting value [Factory default]	Description
Select	<ul style="list-style-type: none"> Internal lighting External lighting 	Select a lighting used in the unit.*1

*1. Internal lighting and external lighting cannot be used at the same time.

- 3 In the *Lighting control* area, specify the brightness.

Displayed contents vary depending on the connected camera, electronic flash controller, or camera-mount lighting controller.

● **Camera-mount Lighting Controller FL-TCC1 is Connected:**

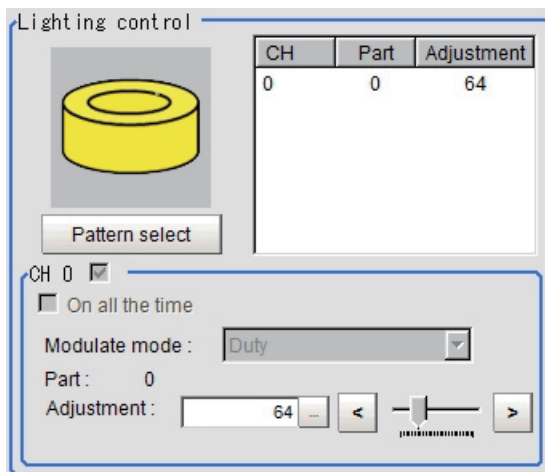

Setting item	Setting value [Factory default]	Description
Pattern select	-	Selects one of the preset lighting patterns.
Part	0 to 255 [64]	Sets the brightness for the selected parts.



Precautions for Correct Use

Per its specifications, the FL-TCC1 cannot emit light longer than 50ms. For that reason, note the following restrictions.

When using Global Reset

- Even if the shutter speed is increased to 50ms or more, it does not become brighter.

When using Rolling Shutter

- When the Reset Mode is set to Rolling Shutter, the lower part of the image will become darker.
- When the Reset Mode is set to Global Reset, even if the shutter speed is increased to 50ms or more, it does not become brighter.

To avoid this restriction, use the FLV-TCC□.

● Camera-mount Lighting Controller FLV-TCC1 is Connected:

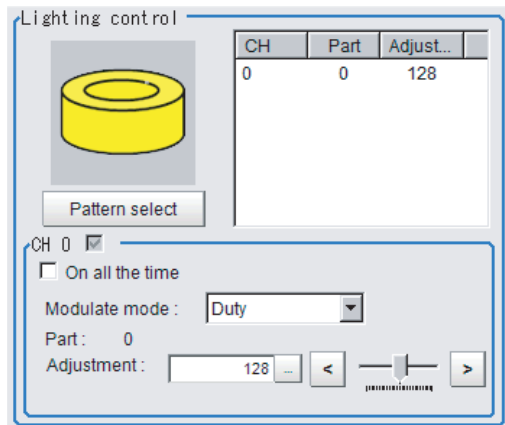

Setting item	Setting value [Factory default]	Description
Pattern select	-	Selects one of the preset lighting patterns.
On all the time	<ul style="list-style-type: none"> • Checked • [Unchecked] 	Places a check here to keep the lighting turned ON all of the time regardless of the exposure time.
Modulate mode	<ul style="list-style-type: none"> • [Duty] • Voltage/Current 	Selects the lighting adjustment method. <ul style="list-style-type: none"> • Duty The light emitting volume is adjusted with a pulse width of 255 gradation (PWM frequency: 100 kHz). • Voltage/Current The light emitting volume is adjusted with voltage/current levels of 255 gradation. Selects voltage/current adjustment when using this with a high-speed shutter speed.
Part	0 to 255 [128]	Sets the brightness for the selected parts.

● Camera-mount Lighting Controller FLV-TCC4 is Connected:

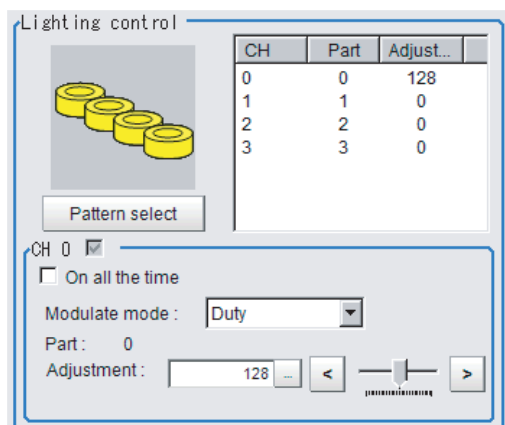

Setting item	Setting value [Factory default]	Description
Pattern select	-	Selects one of the preset lighting patterns.
On all the time	<ul style="list-style-type: none"> • Checked • [Unchecked] 	Places a check here to keep the lighting turned ON all of the time regardless of the exposure time.

Setting item	Setting value [Factory default]	Description
Modulate mode	<ul style="list-style-type: none"> [Duty] Voltage/Current 	Selects the lighting adjustment method. <ul style="list-style-type: none"> Duty The light emitting volume is adjusted with a pulse width of 255 gradation (PWM frequency: 100 kHz). Voltage/Current The light emitting volume is adjusted with voltage/current levels of 255 gradation. Selects voltage/current adjustment when using this with a high-speed shutter speed.
Part	0 to 255 [128]	Sets the brightness for the selected parts.

● Camera-mount Lighting Controller FL-TCC1PS is Connected:

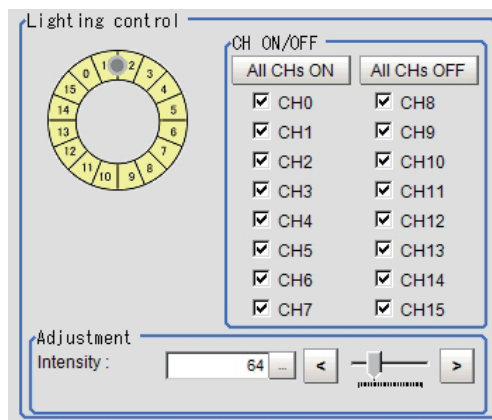

Setting item	Setting value [Factory default]	Description
All CHs ON	-	Sets all channels to ON.
All CHs OFF	-	Sets all channels to OFF.
CH0 to CH15	<ul style="list-style-type: none"> [Checked] Unchecked 	Sets ON / OFF for each channel.
Intensity	0 to 255 [64]	Sets light intensity.

● Internal Lighting: FHV-LTM-R/FHV-LTM-W/FHV-LTM-IR are connected:

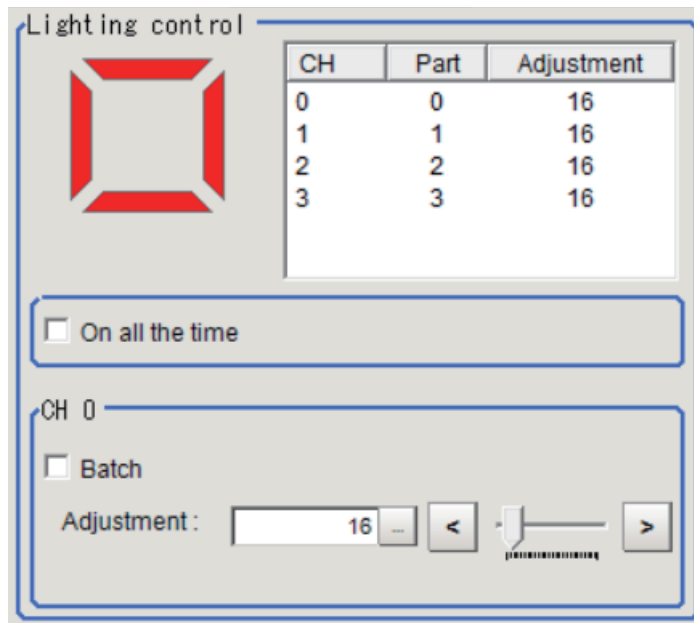

Setting item	Setting value [Factory default]	Description	
Schematic diagram	—	Display the lighting state. Channels with 0 setting value are displayed in gray. Channels with 1 or more setting value are displayed in the following color. <ul style="list-style-type: none"> • FHV-LTM-R: Red • FHV-LTM-W: White • FHV-LTM-IR: Orange 	
On all the time	<ul style="list-style-type: none"> • Checked • [Unchecked] 	Place a check here to keep the lighting turned ON all the time regardless of the exposure time. Since the lighting is not lit all the time in the state and it is just flashing at high-speed, the image input feature does not properly operate with image elements of rolling shutter type: FHV7□-M063R□/FHV7□-C063R□/FHV7□-M120R□/FHV7□-C120R□.	
CH 0 to 3	Batch	<ul style="list-style-type: none"> • Checked • [Unchecked] 	The values for all channels change collectively when the Adjustment is performed while this item is checked.
	Adjustment	0 to 255	Adjust setting values of channels selected in the list.

● Internal Lighting, FHV-LTM-MC is connected:

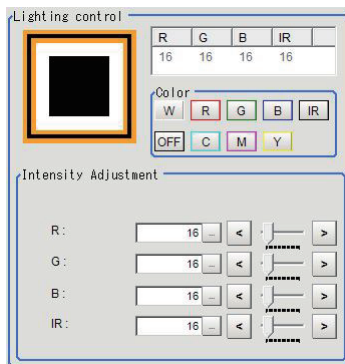

Setting item	Setting value [Factory default]	Description
Schematic diagram	-	Display the light status. Displayed color varies depending on each setting value.
Color		Set the preset value for each button: R (Red), G (Green), B (Blue), IR (IR).
W button	-	<ul style="list-style-type: none"> • R: 50 • G: 50 • B: 50 • IR: 0
R button	-	<ul style="list-style-type: none"> • R: 255 • G: 0 • B: 0 • IR: 0
G button	-	<ul style="list-style-type: none"> • R: 0 • G: 255 • B: 0 • IR: 0
B button	-	<ul style="list-style-type: none"> • R: 0 • G: 0 • B: 255 • IR: 0
IR button	-	<ul style="list-style-type: none"> • R: 0 • G: 0 • B: 0 • IR: 255
C button	-	<ul style="list-style-type: none"> • R: 0 • G: 100 • B: 100 • IR: 0
M button	-	<ul style="list-style-type: none"> • R: 100 • G: 0 • B: 100 • IR: 0
Y button	-	<ul style="list-style-type: none"> • R: 100 • G: 100 • B: 0 • IR: 0

Setting item	Setting value [Factory default]	Description
OFF button	-	<ul style="list-style-type: none"> R: 0 G: 0 B: 0 IR: 0
Intensity	-	Set the emitting intensity individually.*1*2
R	0 to 255 [16]	Set a value for R (red).
G	0 to 255 [16]	Set a value for G (green).
B	0 to 255 [16]	Set a value for B (blue).
IR	0 to 255 [16]	Set a value for IR (IR).

- *1. If a value that cannot be set is entered, an error is displayed. In that case, specify a value within the acceptable range.
- *2. Fine-tuning is hard with the slider, the maximum value cannot be set sometime. If an error is displayed while the slider is operated, use buttons for it.



Additional Information

Lighting directions of the internal lighting FHV-LTM-MC cannot be controlled unlike the single color lighting (FHV-LTM-R/FHV-LTM-W/FHV-LTM-IR). All lighting is only turned on or off.

Line Bright

A graph showing gray distribution for one line in the image is called the *Line bright*. Each line bright corresponding to R, G, B for any line in horizontal and vertical directions is displayed.

- 1** In the Item tab area, click **Screen adjust**.

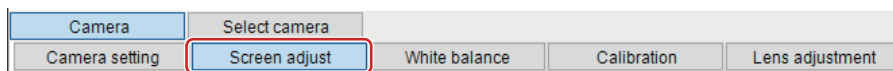

- 2** Place a check to the *Display line bright*.

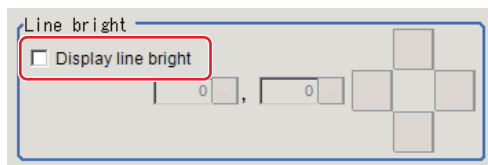

- 3** Move the line to a position whose density distribution is desired to see.

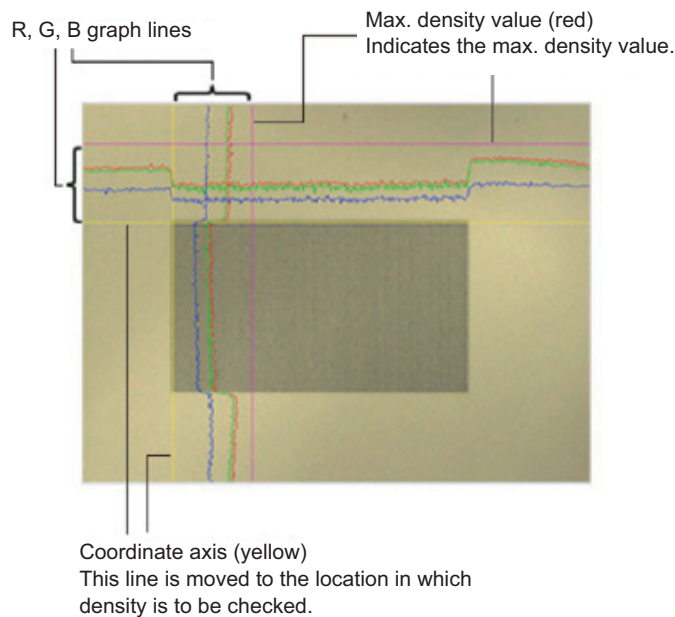

1-3-5 White Balance (Camera Image Input FHV)

This feature compensates the color of images loaded from a camera and sets the white balance to make white objects look white.

By adjusting the white balance, proper white color is reproduced with any type of lighting. Moreover, optimum values can also be set automatically.



Additional Information

- The white balance setting is only available when a color camera is used.
- In the following cases, make sure to set the white balance.
 - Newly installed
 - A camera or lighting is changed

Since measurement results may vary with changes in the white balance settings, make sure to verify the operation.

- 1 In the Item tab area, click the **White balance**.

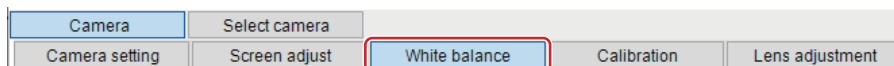

- 2 Shoot a white piece of paper or cloth.

- 3 Set the *Camera adjust* in the *Common setting for all cameras*.

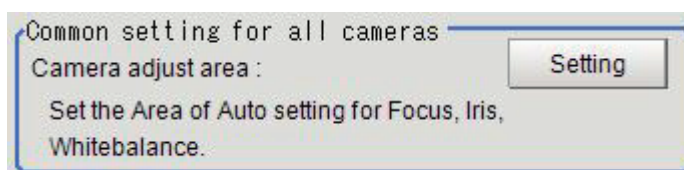

- 4 Click the **Auto**.

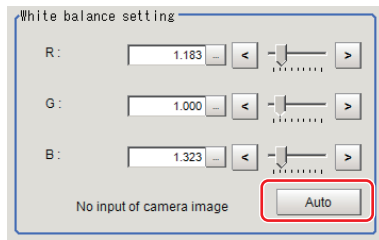

Additional Information

When the *Too bright* or *Too dark* message is displayed, adjust the iris, shutter speed, gain and/or lighting conditions until *Automatic adjustment is possible.* is displayed.

- 5** Set the *R*, *G*, and *B* values as necessary.

Setting item	Setting value [Factory default]	Description
White balance setting	0.001 to 7.999 [1]	Set the white balance.
• R	(R, G, B respectively)	Increasing the values of <i>R</i> , <i>G</i> , and <i>B</i> increases whiteness.
• G		
• B		

1-3-6 Calibration (Camera Image Input FHV)

By setting the calibration, the measurement result can be converted and output as actual dimensions. The calibration method is selected here.

There are three calibration methods, point, sampling, and parameter.

- *Specifying Points and Setting (Point Specification)* on page 1-83
- *Setting Calibration through Sampling Measurement (Sampling)* on page 1-85
- *Inputting and Setting Values (Numerical Value Specification)* on page 1-87
- *View Calibration Parameters* on page 1-88



Additional Information

For outputting measurement values in actual dimensions, select the *Calibration* in the *Output parameter* for each processing unit to *ON*. When the *Calibration* is *OFF* (factory default), then measurement values are output as camera image coordinates.

Specifying Points and Setting (Point Specification)

This is a method for performing calibration by selecting arbitrary points (in pixels).

Calibration parameters are automatically calculated by entering actual coordinates of selected positions. Up to three points are possible to select.

- When the magnification of X and Y directions is the same:
Select two points.

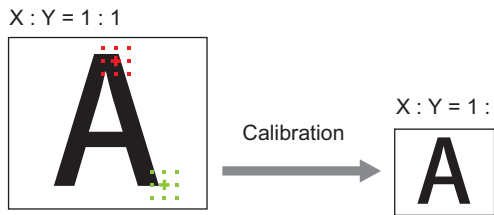

- When the magnification of X and Y directions is not the same:
Select three points.



Additional Information

When two points are selected, the coordinate system is set to the left-handed system (clock-wise). When performing the calibration including the coordinate system, select three points.

- 1 In the Item tab area, click the **Calibration**

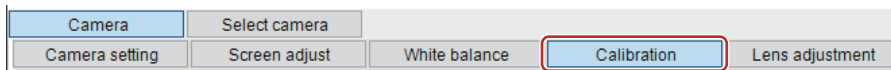

- 2 In the Calibration setting area, select the *Specify point*.

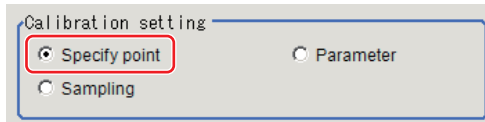

- 3 Click the first point on the screen.

- 4 Set the actual coordinates for the specified point.
The actual coordinate input window is displayed.

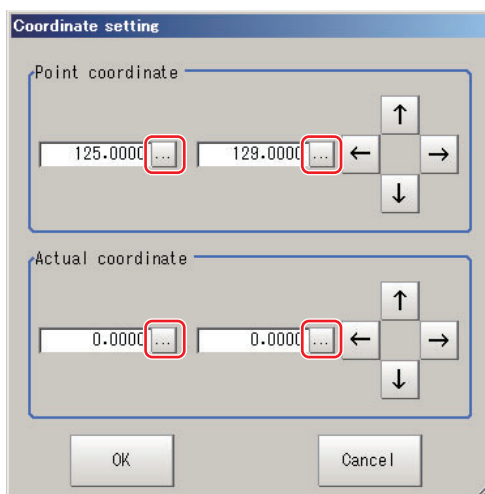

Setting item	Setting value [Factory default]	Description
Point coordinate X, Y	0 to 9,999.9999 [Point clicked in the window]	-
Actual coordinate X, Y	-99,999.9999 to 99,999.9999 [0]	-

5 Set the second and third points in the same way.

6 Click the **Generate calibration parameters**.
The calibration parameters will be generated.

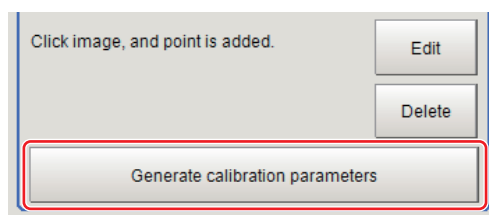

Setting Calibration through Sampling Measurement (Sampling)

This is a method for setting calibration based on measurement results.

Calibration parameters are automatically calculated by searching a registered model and setting the actual coordinate of the position.

1 In the Item tab area, click the **Calibration**

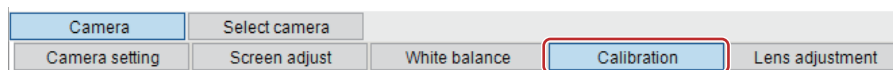

2 In the *Calibration setting* area, select the *Sampling*.

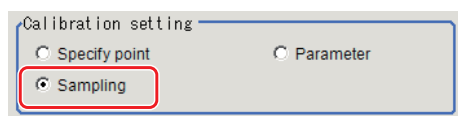

3 In the *Sampling* area, click the **Register model**.

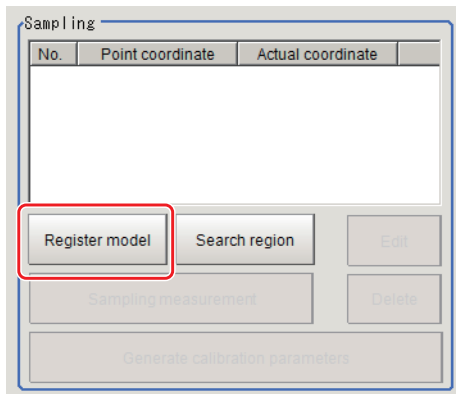

4 Register the model with the Drawing tools.

5 Set a search region as necessary.
The initial value is the entire screen.

6 Click **Sampling measurement**.

Measurement is performed.

The search result (crosshair cursor) is displayed in the *Image Display* area and the *Sampling Coordinate* window is displayed.

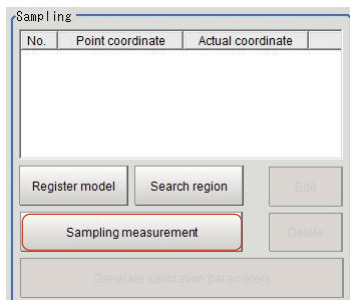

7 In the *Sampling Coordinate* window, set the X and Y values.

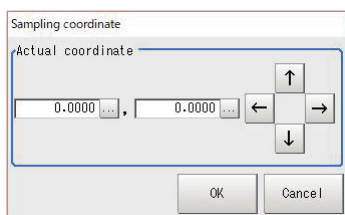

8 Click **OK**

The point coordinates and actual coordinates are registered in the *Sampling* area.

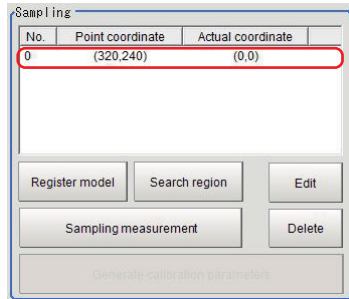

9 Move the measurement object and repeat the step 3 to 8.

10 Click the **Generate calibration parameters**.
The calibration parameters will be generated.

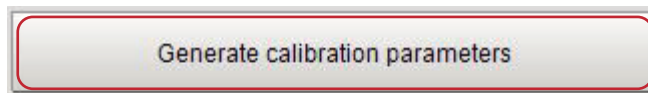

Inputting and Setting Values (Numerical Value Specification)

Set calibration data directly with numerical values.

1 In the Item tab area, click the **Calibration**

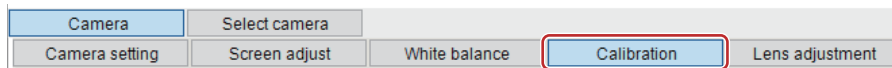

2 In the *Calibration setting* area, select the *Parameter*.

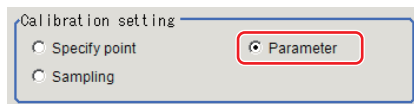

3 In the *Parameter* area, specify values for *Coordinate*, *Origin*, *Magnification*.

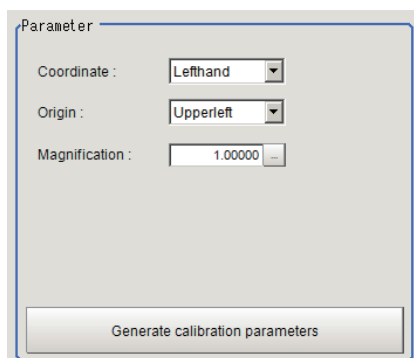

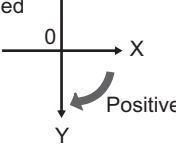
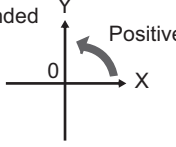
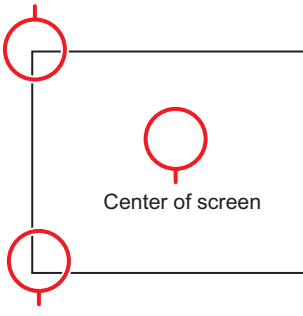
Setting item	Setting value [Factory default]	Description
Coordinate	<ul style="list-style-type: none"> [Lefthand] Righthand 	<ul style="list-style-type: none"> Lefthand The clockwise is forward when setting the coordinates. Righthand The counter-clockwise is forward when setting the coordinates. <p>Lefthanded</p>  <p>Righthanded</p> 
Origin	<ul style="list-style-type: none"> [Upper left] Lower left Center 	<p>Sets the origin of the actual coordinates.</p> <p>Upper left of screen</p>  <p>Center of screen</p> <p>Lower left of screen</p>
Magnification	0.00001 to 9.99999	Specifies the ratio of one pixel to the actual dimensions.

- 4** Click the **Generate calibration parameters**.
The calibration parameters will be generated.



View Calibration Parameters

View the set calibration data.

- 1** In the Item tab area, click the **Calibration**

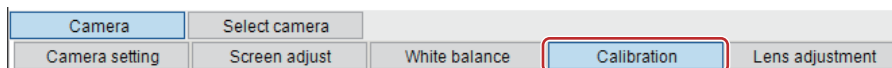

- 2** In the *Calibration parameter* area, confirm the calibration data.

Calibration parameter			
A:	1.000000	D:	0.000000
B:	0.000000	E:	1.000000
C:	0.000000	F:	0.000000
Field of view :	640.000000		

Setting item	Setting value	Description
A	Calculation value	These are calibration conversion values. Camera coordinates are converted to actual coordinates based on these values.
B	Calculation value	
C	Calculation value	
D	Calculation value	The conversion formulas for actual coordinates are as follows: (X, Y): Measurement point (camera coordinates), Unit: pixel (X', Y'): Conversion point (actual coordinates) $X' = A \times X + B \times Y + C$ $Y' = D \times X + E \times Y + F$
E	Calculation value	
F	Calculation value	
Field of view	Calculation value	An actual dimension in the X direction.

1-3-7 Lens Adjustment (Camera Image Input FHV)

Adjust the focus of a lens module.

- *Lens Adjustment Settings* on page 1-89
- *Lens Adjustment* on page 1-90

Lens Adjustment Settings

Sets the focus of a lens module.

- 1 In the Item tab area, click **Lens adjustment**.

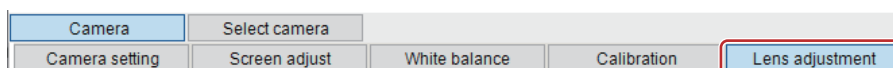

- 2 In the *Common setting for all cameras* area, set the *Camera adjust* area.

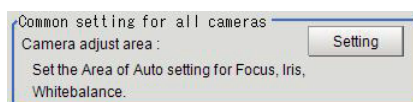

- 3 In the *Lens adjustment* area, specify a value for the *Focus*.

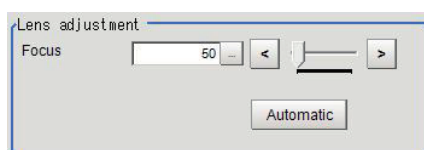

Setting item	Setting value [Factory default]	Description
Focus	FHV-LEM-S06: 26 to 260 [50] FHV-LEM-S09: 18 to 480 [50] FHV-LEM-S12: 47 to 815 [50] FHV-LEM-S16: 10 to 685 [50] FHV-LEM-S25: 37 to 885 [50] FHV-LEM-H06/FHV-LEM-H19 : 0 to 1,023 [50]	Sets the focus value.
Automatic	-	This is used to set the focus value automatically. (Autofocus)* ¹ Sets the <i>Focus</i> automatically to the <i>Camera adjust area</i> in the <i>Common setting for all cameras</i> .

*1. The time for automatic focus adjustment varies depending on the initial value, range, and adjustment area, also camera settings and lighting settings.

Lens Adjustment

Check the focus adjusting state using a focus evaluation value.

- 1 In the Item tab area, click **Lens adjustment**.

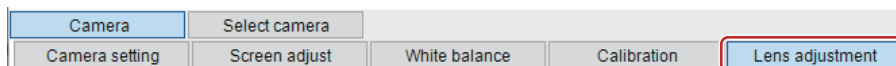

- 2 In the *Lens adjustment* area, check the focus evaluation value.
The history of the focus evaluation value for captured images are graphed.

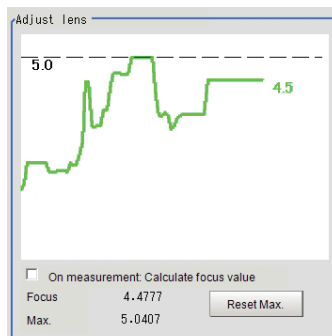

Setting item	Setting value [Factory default]	Description
On measurement: Calculate focus value	<ul style="list-style-type: none"> • Checked • [Unchecked] 	Set whether or not to calculate the focus evaluation value at measurements. <ul style="list-style-type: none"> • Checked: Calculate • Unchecked: Not calculate
Focus	—	Display the focus evaluation value for the latest captured image.
Max.	—	Display the maximum focus evaluation value so far.
Max. reset	—	Use this when clearing the history of focus evaluation values so far.

1-3-8 External Reference Tables (Camera Image Input FHV)

No.	Data name	Data ident	Set/Get	Data range
None	Judge	judge	Get only	0: No judgment (unmeasured), 1: Judgment result OK, -1: Judgment result NG, -10: Error (image format mismatch), -11: Error (unregistered model), -12: Error (insufficient memory), -20: Error (other errors)
None	Internal light brightness	internalLightGain	Set/Get	The brightness for each part is expressed in hexadecimal. Part 0 to Part 4 values in order from left to right. Example: ffffffff when light brightness for Part 0 to Part 3 is set to 255(ff).
None	Internal light on all the time	internalLightAlwaysLight	Set/Get	Set the lighting mode of the internal lighting 0: Pulse lit 1: Always lit
None	Select light	lightMode	Set/Get	Select light 0: External light 1: Internal light
None	Internal light on all the time brightness	internalLightAlwaysLightGain	Set/Get	The brightness for each part is expressed in hexadecimal. Part 0 to Part 4 values in order from left to right. Example: ffffffff when light brightness for Part 0 to Part 3 is set to 255(ff).
None	CH	lightEnabledChannel	Set/Get	0: OFF 1: ON
None	Modulate mode	lightGainMode	Set/Get	It expresses the dimming method of each Part by the sum of 4 bit units. 0: Duty 1: Voltage/Current. Example: When Part 0, Part 2, Part 5 are set to Voltage/Current, 1048833

No.	Data name	Data ident	Set/Get	Data range
None	Internal light model	internalLightModelInfo	Set/Get	Model and type of Internal light, Serial No., Hardware version
None	On all the time	alwaysLight	Set/Get	0: OFF 1: ON
None	Lens model	lensModelInfo	Set/Get	Model and type of Lens module, Serial No., Hardware version
None	Calculate focus at measurement	enableFocusEvaluation	Set/Get	Calculate focus at measurement 0:Disable 1:Enable
None	Calibration parameter	calibParameter	Set/Get	"," Separated by A B C D E F
None	focus evaluation	focusEvaluation0	Get only	focus evaluation
None	Focus	focus	Set/Get	
None	Zoom	zoom	Set/Get	
None	White balance	whiteBalance	Set/Get	"," Separated by R G B
None	Iris	iris	Set/Get	
None	Lighting control(Site List)	lightGain	Set/Get	A representation of a lighting brightness of each Part in hexadecimal . A value of Part 0 ~ Part 7 from left to right . Example: If the illumination brightness of Part 0 ~ Part 3 was in 255 (ff), ffffffff00000000
None	Gain	gain	Set/Get	
None	Shutter speed	exposureTime	Set/Get	
None	Mirror an image(←→)	reverseX	Set/Get	0: OFF 1: ON
None	Mirror an image(↑↓)	reverseY	Set/Get	0: OFF 1: ON
None	Transfer image	cameraMask	Set/Get	Bit sum of the camera does not transfer 1: camera0 2: Camera1 4: Camera2 8: Camera3 16: Camera4 32: camera5 64: camera6 128: Camera7
None	Camera No.	cameraNo	Set/Get	
None	Camera model	cameraModel	Set/Get	Connectable camera model name
None	Iris base density	irisDensity	Set/Get	
None	Multi-slope(Enabled)	multiSlopeMode	Set/Get	0: OFF 1: ON
None	STEP - STGOUT delay	strobeDelay	Set/Get	
None	End line	endY	Set/Get	
None	STGOUT polarity	pulsePolarity	Set/Get	0: Negative 1: Positive
None	STGOUT width	pulseWidth	Set/Get	
None	Reset Mode	shutterResetMode	Set/Get	0:Rolling Shutter 1:Global Reset
None	Multi-slope(slides)	multiSlopeKneePoint	Set/Get	
None	Start line	startY	Set/Get	
None	Binning setting	binningY	Set/Get	0: One line 1: Two line

1-4 Camera Image Input HDR (using FH Controller)

You can acquire a wide dynamic range image by combining images photographed consecutively at different shutter speeds.

With objects that generate halation, images with low-contrast, and environments with fluctuation in the lighting, this processing item is an effective substitute for Camera Image Input.

When using the FHV Controller, refer to *1-5 Camera Image Input HDR (using FHV Controller)* on page 1-105.

Used in the Following Case

- To acquire stable images of objects for which halation occurs easily:

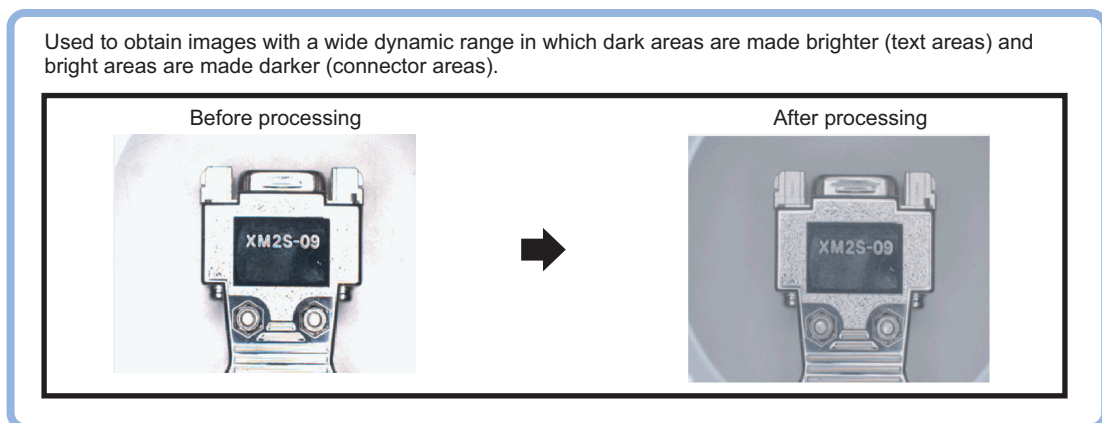

- To measure images with low-contrast stably:
Use high-contrast mode.



Precautions for Correct Use

- MDMC Light FL-MD series is unavailable in *Camera Image Input HDR*.
- Photometric Stereo FL-PS series is unavailable in *Camera Image Input HDR*.
- Camera Image Input FH is preset for Unit 0. Do not set any processing item other than camera image input (Camera Image Input FH, Camera Image Input HDR, Camera Image Input HDR Lite, Photometric Stereo Image Input) for Unit 0.
- Immediately after starting up the Sensor Controller and immediately after changing scenes, there will be no input image. No input image is processed as the same color image as in the factory default state.
- If you open the *Properties* dialog box before inputting an image, click **Cancel** to close the dialog box. Clicking **OK** in the dialog box will change the setting to the same color camera setting as the factory default setting.
- When using FH-S □ 05R/FH-S □ 21R, the Rolling shutter is the only option in the Reset mode.

For details, refer to *FAQ For Measurement The measurement NG (image mismatch) error will result when connecting a monochrome camera in the Vision System FH/FHV Series User's Manual (Cat. No. Z365)*.

- For this processing item, do not use scene variables or system-defined variables as parameters.

1-4-1 Settings Flow (Camera Image Input HDR (using FH Controller))

To set Camera Image Input HDR (using FH Controller), follow the steps below.

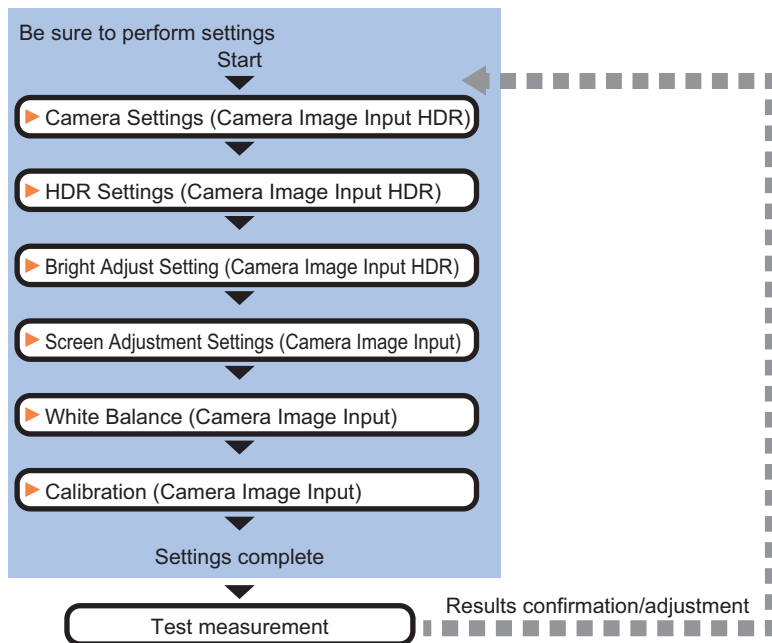

List of Camera Image Input HDR Items

Item	Description
Camera settings	Specify the camera settings such as the electronic flash. <i>1-4-2 Camera Settings (Camera Image Input HDR (using FH Controller))</i> on page 1-95
HDR setting	Specify the image combination and imaging settings. <i>1-4-3 HDR Settings (Camera Image Input HDR (using FH Controller))</i> on page 1-100
Bright adjust	Specify the brightness follow-up adjustment setting. <i>1-4-4 Bright Adjust Setting (Camera Image Input HDR (using FH Controller))</i> on page 1-101
Screen adjust	Adjust the lighting and the lens. The setting method is the same as for Camera Image Input. Please check it. However, the iris cannot be adjusted.
White balance	When using a color camera, adjust the white balance. The setting method is the same as for Camera Image Input. Please check it.
Calibration	Set when measurements (camera coordinate measurement values) are to be output using actual dimensions. Select the calibration setting method and generate the calibration parameters. The setting method is the same as for Camera Image Input. Please check it.
Camera model	The camera model currently connected can be checked. <i>1-4-5 Camera Model (Camera Image Input HDR (using FH Controller))</i> on page 1-102

1-4-2 Camera Settings (Camera Image Input HDR (using FH Controller))

Set the following photographing conditions

Selection Setting

When multiple cameras are connected, select the camera to use for measurement.

- 1 In the Item tab area, click **Camera setting**.

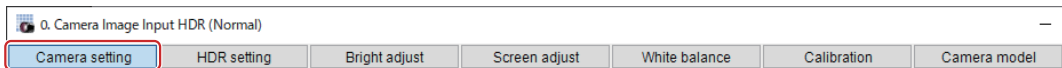

- 2 Click ▼ on the right of the *Camera No.* and select the camera number.

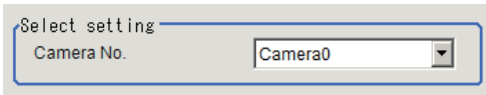

Setting item	Setting value [Factory default]	Description
Camera No.	Camera 0 to 7 [Camera 0]	Select the camera number.

Camera Settings

Specify the camera gain and reverse conversion.

- 1 In the Item tab area, click **Camera setting**.

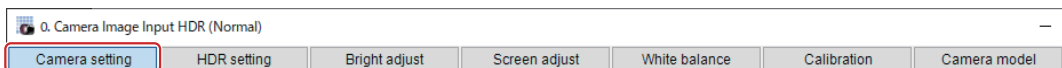

- 2 In the *Camera settings* area, specify the *Gain* and *Mirror an image* settings.

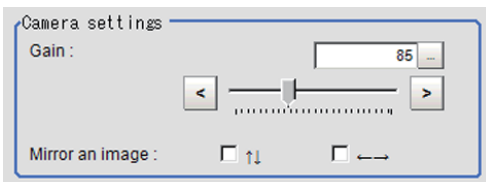

Setting item	Setting value [Factory default]	Description	
Camera gain	FZ-SC/FZ-S/FZ-SHC/FZ-SH 0 to 230 [85] FZ-SC2M/FZ-S2M/FZ-SC5M <input type="checkbox"/> /FZ- S5M <input type="checkbox"/> /FZ-SF <input type="checkbox"/> /FZ-SP <input type="checkbox"/> 0 to 230 [50] FZ-SC5M3 0 to 230 [65] FH-SC02/FH-SM02/FH-SC04/FH-SM04 0 to 255 [0] FH-SC12/FH-SM12 0 to 255 [0] FH-SC05R/FH-SM05R 0 to 63 [0] FH-S <input type="checkbox"/> X/FH-S <input type="checkbox"/> X01/FH-S <input type="checkbox"/> X03/FH-S <input type="checkbox"/> X05/FH-S <input type="checkbox"/> X12 0 to 240 [85] FH-S <input type="checkbox"/> 21R 0 to 200 [85]	Adjusts the <i>Camera gain</i> when the shutter speed, the lens aperture, and lighting conditions cannot be used to brighten the image. Usually, the factory default value can be used.	
Mirror an im- age *1	↑↓	<ul style="list-style-type: none"> • Checked • [Unchecked] 	Places a check here when reversing the camera image vertically.
	← →	<ul style="list-style-type: none"> • Checked • [Unchecked] 	Places a check here when reversing the camera image horizontally.

*1. Supported by FH-SC /FH-SM/FH-SC21R/FH-SM21R.
 Not supported by FH-SC05R/FH-SM05R



Precautions for Correct Use

- Due to the specification of its imaging elements, a CMOS camera generates stripe noises when the gain setting of the camera is raised. You may also find multiple defective pixels, but they do not represent a defect or failure of the product in any way. If stripe noises and defective pixels affect the measurement results, lower the gain setting of the camera or use a CCD camera.
- When performing defect inspection, keep the gain setting at a low value to suppress the influence of image noise.

Binning Settings for Monochrome Cameras only (Not supported by FH-SMX/FH-SMX01/FH-SM21R)

Binning is a function for obtaining a single value by adding multiple lines together.

Some cameras give the effect of a higher frame rate by raising the sensitivity of the brightness virtually by adding together and decreasing the amount of data to be transferred.



Precautions for Correct Use

The effects that can be obtained with different cameras are as follows.

Camera model	Brightness Sensitivity	Frame rate
FZ-S/FZ-S2M/FZ-S5M3/FZ-SH/FZ-SF/FZ-SP	Effective	Effective
FH-SMX03/FH-SMX05/FH-SMX12	Effective	Effective
FH-SM/FH-SM02/FH-SM04/FH-SM12	Effective	No effect
FH-SM05R	No effect	Effective

- In the Item tab area, click **Camera setting**.
In the *Binning settings* area, select either *1 line* or *2 lines*.

Setting item	Setting value [Factory default]	Description
Binning setting	<ul style="list-style-type: none"> [1 line] 2 lines 	<ul style="list-style-type: none"> 1 line Data is transferred line by line. 2 lines Data is transferred two lines at a time. Each image is scanned skipping one scan line per two consecutive lines. Measurement precision is decreased because the image resolution in the vertical direction is lower.

Number of Lines to be Read

By narrowing the image range to be loaded, the image scan time can be shortened.

Set the range taking the offset of the measurement object into consideration.

The part of the image narrowed down by the start line and the end line will be displayed in the setting screen of the processing item window and the Image Display area of the Main screen.

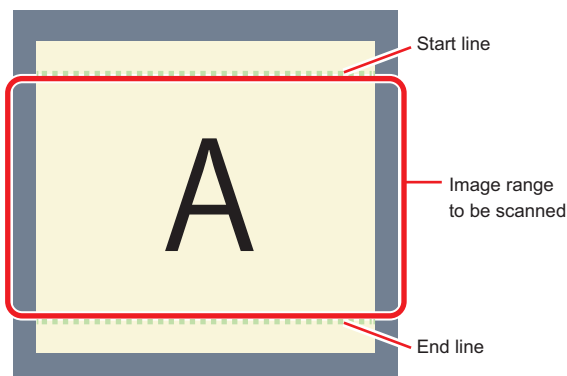



Additional Information

About minimum number of lines:

- With the FH-SM □□/ FH-SMX □□/ FH-SM05R, the minimum number of lines (minimum value between the start and end lines) is 4 line.
- With the FH-SC □□/ FH-SCX □□/ FH-SC05R, the minimum number of lines is 4 lines.
- With the FZ-S □□□ excluding the FZ-SQ series and FZ-S □ 5M3, the minimum number of lines is 12 lines.
- With the FZ-SQ series, the minimum number of lines is 8 lines.
- With the FZ-S □ 5M3, the minimum number of lines is 4 lines.
- For FZ-S □ 5M3, the step width of the Start and End lines is 4 lines. When loading a scene created with the FZ-S □ 5M2, the number of lines loaded will be a maximum of 4 lines.
- With the FH-S □ 21R, the minimum number of lines is 1,848 lines.

About coordinate values:

- The coordinate values displayed as the measurement results are the values of the display position on the monitor.
- The coordinate values do not vary according to the settings for "Number of lines to be read".

- 1 In the Item tab area, click **Camera setting**.

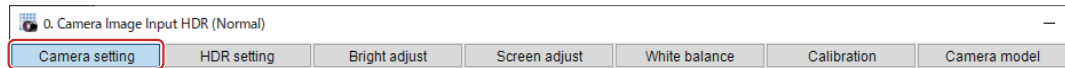

- 2 Set the start and end lines in the *Number of Lines to be Read* area.

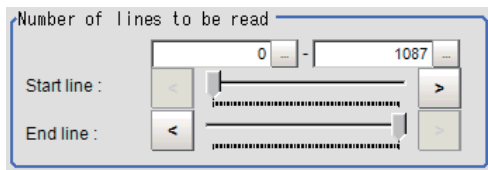

Precautions for Correct Use

- When the built-in lighting of an FZ-SQ□□□□ is used, it may not be possible to shorten the processing time due to restrictions on the light emission time.
- If the following cameras are used with the binning setting set to 2 lines, set the number of capture lines to be a multiple of 8.
FH-SMX03, FH-SMX05, FH-SMX12, FZ-S5M3

Electronic Flash Setting

This is one of the Camera Image Input HDR (using FH Controller) processing items and is used when an electronic flash is used. This sets the output conditions for the signal to synchronize the measurement and the electronic flash timing.



Precautions for Correct Use

- The STGOUT signals that can be output are as follows.
 - FH-2000/FH-5000 series: SGTOU 0 to 7
 - FH-L series: STGOUT 0 to 3
- STGOUT0 to STGOUT7 is tied to the camera connector number of the sensor controller, not the camera number. When you use CameraLink Medium Configuration or the Multi-line random-trigger mode, confirm the camera connector number that corresponds to the camera number of Sensor Controller.

1 In the Item tab area, click **Camera setting**.

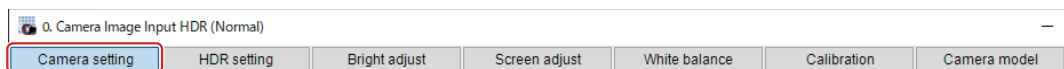

2 In the *Electronic flash setting* area, specify each item.

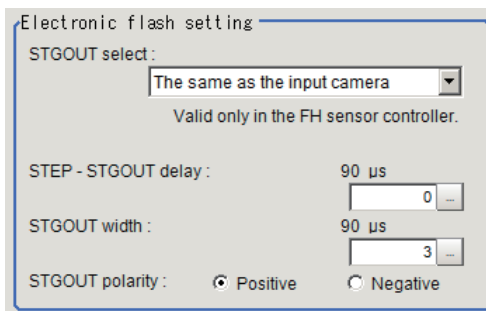

Setting item	Setting value [Factory default]	Description
STGOUT select	[Same as the input camera] Camera 0 to 7	Select the STGOUT sGain <ul style="list-style-type: none"> Same as the input camera: STGOUT that is tied to the input camera is output. Camera 0 to 7: STGOUT signal that is tied to the selected camera is output.
STEP-STGOUT delay	0 to 511 [0] (1 count: 30 [μs])	Sets the waiting time from the time the start of this camera image input processing item until the electronic flash trigger output signal comes ON. $\text{Delay time} = \text{Count} \times 30 \mu\text{s} + 90 \mu\text{s}$ The delay time varies depending on the <i>polarity of STGOUT pulse</i> . The displayed time is for the positive polarity. Add 35 [μs] to the displayed time when the polarity is negative. The display time becomes within a range of ±10 [μs] to the setting value.
STGOUT width	0 to 43,689 [3] (1 count: 30 [μs])	Sets the output time for the electronic flash trigger signal. If 0 is set, the electronic flash will not flash.

Setting item	Setting value [Factory default]	Description
STGOUT polarity	<ul style="list-style-type: none"> • [Positive] • Negative 	Selects the pulse polarity of the electronic flash trigger. <ul style="list-style-type: none"> • Positive polarity Flashes synchronized with the timing of the electronic flash trigger output signal changing from OFF to ON. • Negative polarity Flashes synchronized with the timing of the electronic flash trigger output signal changing from ON to OFF.



Precautions for Correct Use

- Do not perform next camera image input processing before STGOUT signal output is completed. If it were done, STGOUT signal may not be output. Perform camera image input processing after STGOUT signal output is completed or set the STEP-camera delay, STEP-STGOUT delay, and STGOUT pulse width properly so that the electronic flash flashes synchronizing with the exposure time.



Additional Information

STGOUT signals are output at each imaging. Therefore, it can be duplicated with the next STGOUT signal output, depending on the STEP-STGOUT delay or STGOUT width settings. If it duplicates with the next, the number of times for imaging and electronic flashing can differ.

1-4-3 HDR Settings (Camera Image Input HDR (using FH Controller))

Specify the image combination method etc.

- 1** In the Item tab area, click **HDR setting**.
- 2** In the *Mode select* area, specify the mode.
When you select the mode in the *Mode select* area and specify the measurement region on the image, the parameters are set automatically. To finely adjust the parameters, refer to the next items.

Setting item	Setting value [Factory default]	Description
Mode select	<ul style="list-style-type: none"> • [HDR mode] • High-contrast mode 	<ul style="list-style-type: none"> • HDR mode In halation is likely generated image, select this mode if you want to stabilize the brightness. • High-contrast mode Generate images with stabilized brightness by imaging multiple images with different shutter speeds based on the set Average and Width.

- 3** In the *Image input setting* area, set each item.
A brightness histogram is displayed as the graph.

• HDR mode:

• High-contrast mode:

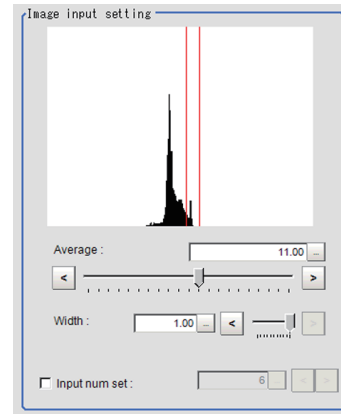
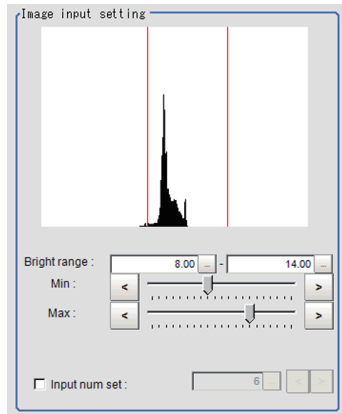

Setting item	Setting value [Factory default]	Description
Min. Bright range	0 to 20 [8]	Set the minimum brightness for combining images.
Max. Bright range	0 to 20 [14]	Set the maximum brightness for combining images.
Average	0.00 to 20.00 [11.00]	Specify the average brightness for images shot.
Width	0.01 to 1.00 [1.00]	Specify the brightness range for images shot.
Input num set	<ul style="list-style-type: none"> Checked 2 to 16 [6] [Unchecked] 	Place a check to set the number of shots manually. Setting a high shot count provides images with low noise. However, the processing time becomes long. Setting a low shot count shortens the processing time. However, the image is more easily affected by noise.

- 4** In the *Output setting* area, set the combination method.
The current shot count and image combination time for the settings are displayed.

Setting item	Setting value [Factory default]	Description
Combine type	<ul style="list-style-type: none"> [Normal] Color Linear 	Select the combination <ul style="list-style-type: none"> • Normal: Standard combination method. This compensates the brightness so that dark sections on the combination image do not become all black. • Color: This is suitable for inspecting labeling and the Gravity and Area. This compensates the saturation when there is little hue information in the combined image. • Linear: This is suitable for fine matching and defect inspection. In order to output the actual brightness of the workpiece, no correction is applied.

1-4-4 Bright Adjust Setting (Camera Image Input HDR (using FH Controller))

This sets how far to track the brightness of the images to load.

- 1** In the Item tab area, click **Bright adjust**.

2 Set each item in the *Bright adjust setting* area.

When placing a check at the *Bright adjust*, the Brightness Adjustment range is displayed with blue lines in the *Histogram* area.

Change the *Adjust bright ave.* and *Brightness adjust area* as necessary.

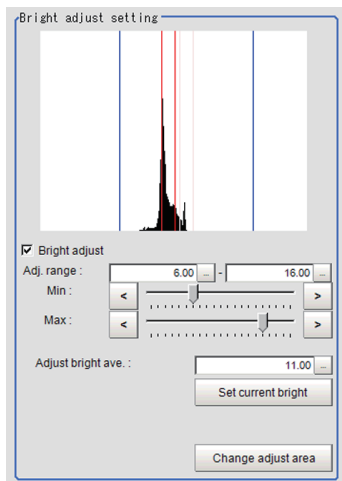

Setting item	Setting value [Factory default]	Description
Bright adjust	<ul style="list-style-type: none"> Checked [Unchecked] 	When placing a check at <i>Bright adjust</i> , the image is output with its brightness automatically compensated. This makes it possible to obtain images with stable brightness even if the lighting condition fluctuates, for example, due to interfering light.
Min. Adj range	0.00 to 20.00 [6.00]	Specify the follow-up brightness minimum value.
Max. Adj range	0.00 to 20.00 [16.00]	Specify the follow-up brightness maximum value.
Adjust bright ave.	0.00 to 20.00 [11.00]	Specify the target for brightness follow-up. Clicking the Set current bright updates this value.

1-4-5 Camera Model (Camera Image Input HDR (using FH Controller))

You can check the camera model currently connected.

1 In the Item tab area, click **Camera model**.

2 In the *Camera model* area, you can check the camera model currently connected that is assigned to the camera No. you selected in the *Camera setting* tab.

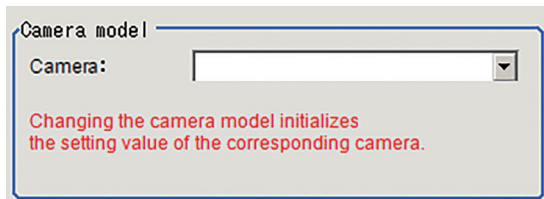

Additional Information

When using the simulation software, you can select any camera model in the *Camera model* area. Changing the camera model will initialize the correspondence camera settings.

1-4-6 External Reference Tables (Camera Image Input HDR (using FH Controller))

No.	Data name	Data ident	Set/Get	Data range
10000	Judge	judge	Get only	0: No judgment (unmeasured), 1: Judgment result OK, -1: Judgment result NG, -10: Error (image format mismatch), -11: Error (unregistered model), -12: Error (insufficient memory), -20: Error (other errors)
None	Modulate mode	lightGainMode	Set/Get	It represents the dimming method for each Part with the sum of 4-bit units. 0: Duty, 1: Voltage and Current. Example: When Part 0, Part 2, and Part 5 are set to Voltage and Current: 1048833
None	Lighting control(Site List)	lightGain	Set/Get	A representation of a lighting brightness of each Part in hexadecimal. A value of Part 0 to Part 7 is presented from left to right. Example: When the illumination brightness of Part 0 to Part 3 was set to 255 (ff): ffffffff00000000
None	On all the time	alwaysLight	Set/Get	0: OFF, 1: ON
None	CH	lightEnabledChannel	Set/Get	0: OFF, 1: ON
None	Follow-up brightness average	brightAverage	Set/Get	
None	The presence or absence of brightness follow-up	adjustBright	Set/Get	0: OFF, 1: ON
None	Combine type	combineMode	Set/Get	0: Normal, 1: Color, 2: Linear
None	The maximum follow-up range	maxAdjustBright	Set/Get	
None	The minimum follow-up range	minAdjustBright	Set/Get	
None	White balance B	whiteBalanceB	Set/Get	
None	White balance G	whiteBalanceG	Set/Get	
None	Binning setting	binningY	Set/Get	0: One line, 1: Two line
None	Calibration parameter	calibParameter	Set/Get	A B C D E F separated by ","
None	White balance R	whiteBalanceR	Set/Get	
None	Focus	focus	Set/Get	
None	Zoom	zoom	Set/Get	
None	Iris base density	irisDensity	Set/Get	
None	Iris	iris	Set/Get	
None	End line	endY	Set/Get	
None	Start line	startY	Set/Get	

No.	Data name	Data ident	Set/Get	Data range
None	STEP - STGOUT delay	strobeDelay	Set/Get	
None	STGOUT selection	stgoutSelect	Set/Get	0: Same as the camera input, 100 + N: N is the camera number.
None	Mirror an image(←→)	reverseX	Set/Get	0: OFF, 1: ON
None	Camera model	cameraModel	Set/Get	Connectable camera model name
None	Camera No.	cameraNo	Set/Get	
None	Mirror an image(↑↓)	reverseY	Set/Get	0: OFF, 1: ON
None	Gain	gain	Set/Get	
None	Lightness width	hcBrightRange	Set/Get	
None	Average brightness	hcAveBright	Set/Get	
None	Input num set(Num-ber of sheets)	shutterNum	Set/Get	
None	Input num set(Enabled)	setShutterNum	Set/Get	0: OFF, 1: ON
None	The maximum brightness	maxBright	Set/Get	
None	STGOUT polarity	pulsePolarity	Set/Get	0: Negative, 1: Positive
None	STGOUT width	pulseWidth	Set/Get	
None	Minimum brightness	minBright	Set/Get	
None	Mode select	highContrastMode	Set/Get	0: HDR mode, 1: High contrast mode

1-5 Camera Image Input HDR (using FHV Controller)

You can acquire a wide dynamic range image by combining images photographed consecutively at different shutter speeds.

With objects that generate halation, images with low-contrast, and environments with fluctuation in the lighting, this processing item is an effective substitute for Camera Image Input.

When using FH Controller, refer to *1-4 Camera Image Input HDR (using FH Controller)* on page 1-93.

Used in the Following Case

- To acquire stable images of objects for which halation occurs easily:

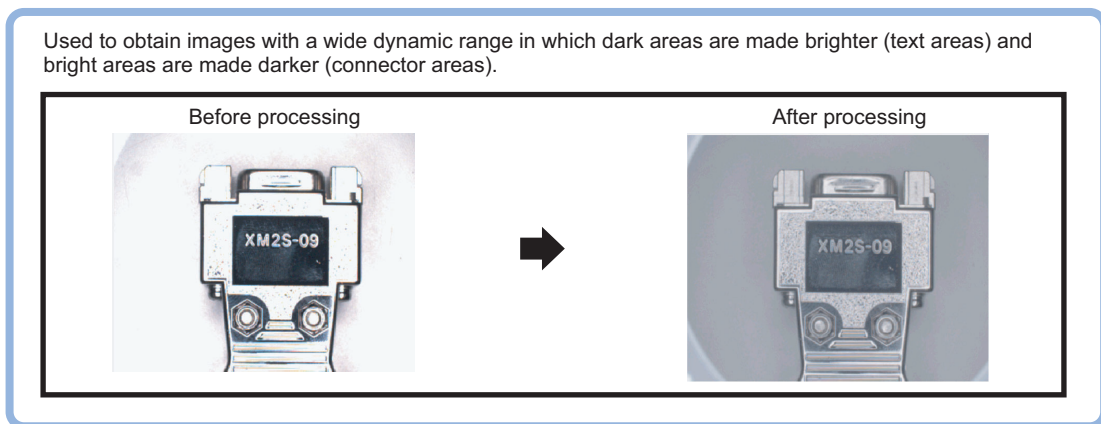

- To measure images with low-contrast stably:
Use high-contrast mode.



Precautions for Correct Use

- Since the display image on the setting screen is refreshed by image composition with continuous capturing, it may take several seconds to change the settings or transit screen on the setting screen.
- Camera Image Input FHV is preset for Unit 0. Do not set any processing item other than Camera image input (Camera image input FHV, Camera image input HDR) for Unit 0.
- MDMC Light FL-MD series is unavailable in *Camera Image Input HDR*.
- Photometric Stereo FL-PS series is unavailable in *Camera Image Input HDR*.
- Immediately after starting up the Sensor Controller and immediately after changing scenes, there will be no input image. No input image is processed as the same color image as in the factory default state.
- If you open the *Properties* dialog box before inputting an image, click **Cancel** to close the dialog box. Clicking **OK** in the dialog box will change the setting to the same color camera setting as the factory default setting.
- When the data for *Camera Image Input HDR* of the FH series is loaded, the setting values for the internal lighting and lens are initialized.
- When the *Always On* option of the internal lighting (FHV-LTM-XXX) is selected, the brightness sometimes becomes unstable, so the image input is not performed successfully.
- For this processing item, do not use scene variables or system-defined variables as parameters.

1-5-1 Settings Flow (Camera Image Input HDR (using FHV Controller))

To set Camera Image Input HDR (using FHV Controller), follow the steps below.

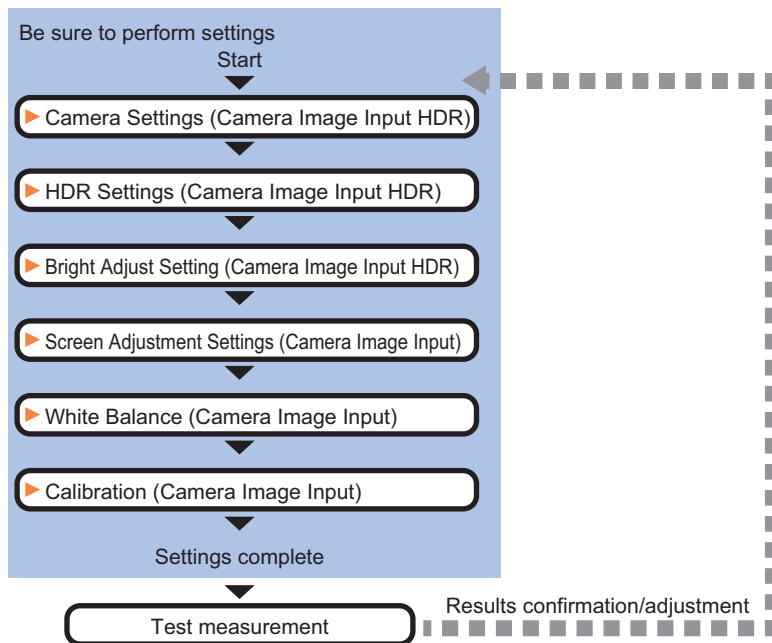

List of Camera Image Input HDR Items

Item	Description
Camera settings	Specify the camera settings such as the electronic flash. <i>1-5-2 Camera Settings (Camera Image Input HDR (using FHV Controller)) on page 1-107</i>
HDR setting	Specify the image combination and imaging settings. <i>1-4-3 HDR Settings (Camera Image Input HDR (using FH Controller)) on page 1-100</i>
Bright adjust	Specify the brightness follow-up adjustment setting. <i>1-4-4 Bright Adjust Setting (Camera Image Input HDR (using FH Controller)) on page 1-101</i>
Screen adjust	Adjust the lighting and lens. The setting method is the same as Camera Image Input FHV.
White balance	When using a color camera, adjust the white balance. The setting method is the same as Camera Image Input FHV.
Calibration	Set when measurements (camera coordinate measurement values) are to be output using actual dimensions. Select the calibration setting method and generate the calibration parameters. The setting method is the same as Camera Image Input FHV.
Lens adjustment	Adjust the focus for a lens. <i>1-5-5 Lens Adjustment (Camera Image Input HDR (using FHV Controller)) on page 1-113</i>
Camera model	Check the type of camera, lighting, and lens that are currently connected. The contents are the same as Camera Image Input FHV.

1-5-2 Camera Settings (Camera Image Input HDR (using FHV Controller))



Additional Information

The display items differ depending on the camera model and lighting mode. Perform the setting with the following procedures according to the usage environment.

Camera Settings

Specify the camera gain and reverse conversion.

- 1 In the Item tab area, click **Camera setting**.
- 2 In the *Camera settings* area, specify the *Gain* and *Mirror an image* settings.

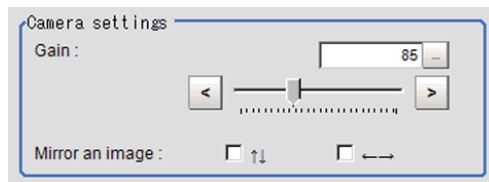

Setting item	Setting value [Factory default]	Description
Camera gain	FHV7□-M004□/FHV7□-M008□/ FHV7□-M016□/FHV7□-M032□/ FHV7□-M050□/FHV7□-C004□/ FHV7□-C008□/FHV7□-C016□/ FHV7□-C032□/FHV7□-C050□ 0 to 240 [0] FHV7□-M063R□/FHV7□-M120R□/ FHV7□-C063R□/FHV7□-C120R□ 0 to 180 [0]	Adjusts the <i>Camera gain</i> when the shutter speed, the lens aperture, and lighting conditions cannot be used to brighten the image. Usually, the factory default value can be used.
Mirror an image	↑↓ • Checked • [Unchecked]	Places a check here when reversing the camera image vertically.
	←→ • Checked • [Unchecked]	Places a check here when reversing the camera image horizontally.



Precautions for Correct Use

- Due to the specification of its imaging elements, a CMOS camera generates stripe noises when the gain setting of the camera is raised. You may also find multiple defective pixels, but they do not represent a defect or failure of the product in any way. If stripe noises and defective pixels affect the measurement results, lower the gain setting of the camera.
- When performing defect inspection, keep the gain setting at a low value to suppress the influence of image noise.

Binning Settings (for Monochrome Camera - FHV□□-M0016□□□ Only)

Binning is a function for obtaining a single value by adding multiple lines together.

In some case, this gives the effect of virtually raising the sensitivity of the brightness by combining multiple lines and another case the effect of increasing the frame rate by decreasing the amount of data to be transferred.

- 1 In the Item tab area, click **Camera setting**.
In the *Binning settings* area, select either *1 line* or *2 lines*.

Setting item	Setting value [Factory default]	Description
Binning setting	<ul style="list-style-type: none"> • [1 line] • 2 lines 	<ul style="list-style-type: none"> • 1 line Data is transferred line by line. • 2 lines Data is transferred two lines at a time. Each image is scanned skipping one scan line per two consecutive lines. Measurement precision is decreased because the image resolution in the vertical direction is lower.

Number of Lines to be Read

By narrowing the image range to be loaded, the image scan time can be shortened.

Set the range taking the offset of the measurement object into consideration.

The part of the image narrowed down by the start line and the end line will be displayed in the setting screen of the processing item window and the Image Display area of the Main screen.

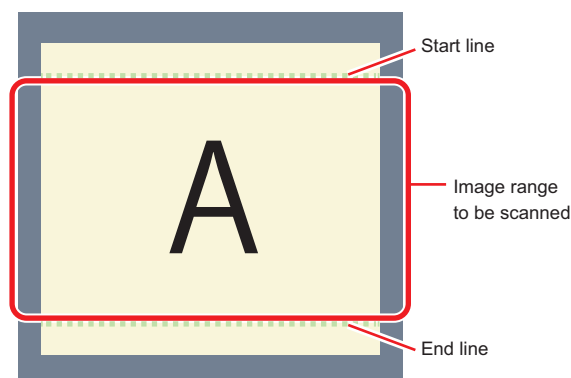



Additional Information

About the minimum number of lines:

- For FHV7□-M004□/FHV7□-M008□/FHV7□-M016□/FHV7□-M032□/FHV7□-M050□/ FHV7□-C004□/ FHV7□-C008□/ FHV7□-C016□/ FHV7□-C032□/ FHV7□-C050□, the minimum number of lines (minimum value between the start and end lines) is 3 lines.
- For FHV7□-M063R□/FHV7□-M120R□/FHV7□-C063R□/FHV7□-C120R□, the minimum number of lines is 3 lines.
- The step width from the start to end lines is 4 lines.

About coordinate values:

- The coordinate values of the measurement results are the display position values on the monitor.
- The coordinate values will not vary with this setting.

- 1 In the Item tab area, click **Camera setting**.

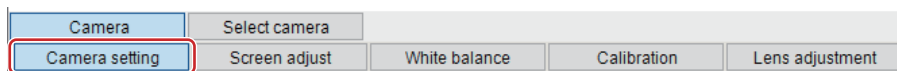

- 2 Set the start and end lines in the *Number of Lines to be Read* area.

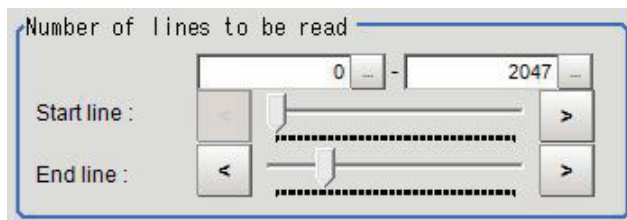

Precautions for Correct Use

When FHV7□-M063R□/FHV7□-M120R□/FHV7□-C063R□/FHV7□-C120R□ is used, the processing time may not be shortened.

Electronic Flash Settings

This function is set when an electronic flash is used. This sets the output conditions for the signal to synchronize the measurement and the electronic flash timing.



Precautions for Correct Use

The setting here applies when *STGOUT* is selected for the output signal in *Common settings* on the *Output signal settings* page of the camera accessed by selecting **Tool - System settings**. When *STGOUT* is selected, the signal is controlled by each setting value of *SHTOUT* for each line.

For details, refer to *Setting the SHTOUT Signal [Output Signal Settings]* in the *Vision System FH/FHV Series User's manual (Cat. No. Z365)*.

- 1 In the Item tab area, click **Camera setting**.

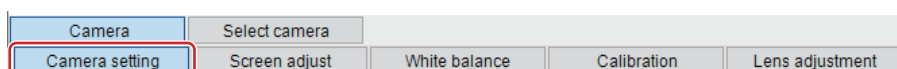

- 2 In the *Electronic flash setting* area, specify each item.

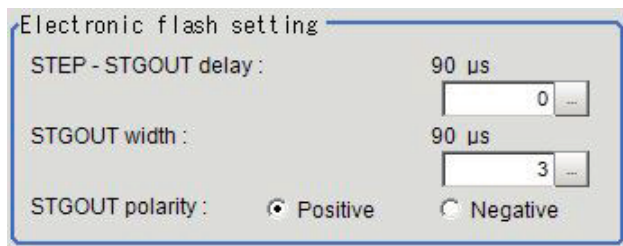

Setting item	Setting value [Factory default]	Description
STEP-STGOUT delay	0 to 511 [0] (1 count: 30 [μs])	Sets the waiting time from the time the start of this camera image input processing item until the electronic flash trigger output signal comes ON. Delay time = Count × 30 μs + 90 μs The delay time varies depending on the <i>polarity of STGOUT pulse</i> . The displayed time is for the positive polarity. Add 35 [μs] to the displayed time when the polarity is negative. The display time becomes within a range of ±10 [μs] to the setting value.
STGOUT width	0 to 43,689 [3] (1 count: 30 [μs])	Sets the output time for the electronic flash trigger signal. If 0 is set, the electronic flash will not flash.
STGOUT polarity	<ul style="list-style-type: none"> • [Positive] • Negative 	Selects the pulse polarity of the electronic flash trigger. <ul style="list-style-type: none"> • Positive polarity Flashes synchronized with the timing of the electronic flash trigger output signal changing from OFF to ON. • Negative polarity Flashes synchronized with the timing of the electronic flash trigger output signal changing from ON to OFF.



Precautions for Correct Use

- Do not perform next camera image input processing before STGOUT signal output is completed. If it were done, STGOUT signal may not be output. Perform camera image input processing after STGOUT signal output is completed or set the STEP-camera delay, STEP-STGOUT delay, and STGOUT pulse width properly so that the electronic flash flashes synchronizing with the exposure time.

1-5-3 HDR Settings (Camera Image Input HDR (using FHV Controller))

Specify the image combination method etc.

- 1** In the Item tab area, click **HDR setting**.
- 2** In the *Mode select* area, specify the mode.
When you select the mode in the *Mode select* area and specify the measurement region on the image, the parameters are set automatically. To finely adjust the parameters, refer to the next items.

Setting item	Setting value [Factory default]	Description
Mode select	<ul style="list-style-type: none"> [HDR mode] High-contrast mode 	<ul style="list-style-type: none"> HDR mode In halation is likely generated image, select this mode if you want to stabilize the brightness. High-contrast mode Generate images with stabilized brightness by imaging multiple images with different shutter speeds based on the set Average and Width.

- 3** In the *Image input setting* area, set each item.
A brightness histogram is displayed as the graph.

- HDR mode:

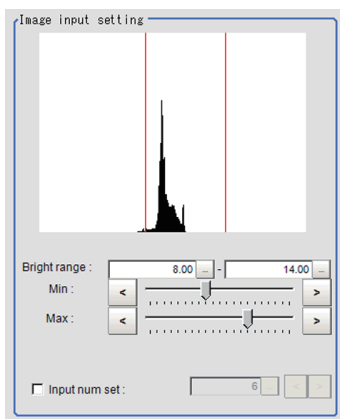

- High-contrast mode:

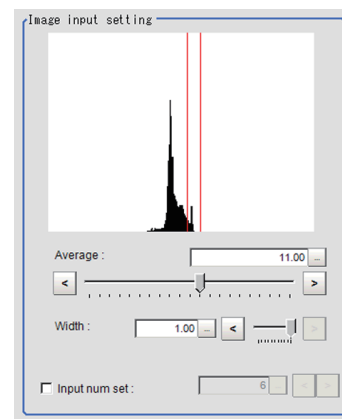

Setting item	Setting value [Factory default]	Description
Min. Bright range	0 to 20 [8]	Set the minimum brightness for combining images.
Max. Bright range	0 to 20 [14]	Set the maximum brightness for combining images.
Average	0.00 to 20.00 [11.00]	Specify the average brightness for images shot.
Width	0.01 to 1.00 [1.00]	Specify the brightness range for images shot.
Input num set	<ul style="list-style-type: none"> Checked 2 to 16 [6] [Unchecked] 	Place a check to set the number of shots manually. Setting a high shot count provides images with low noise. However, the processing time becomes long. Setting a low shot count shortens the processing time. However, the image is more easily affected by noise.

- 4** In the *Output setting* area, set the combination method.
The current shot count and image combination time for the settings are displayed.

Setting item	Setting value [Factory default]	Description
Combine type	<ul style="list-style-type: none"> • [Normal] • Color • Linear 	Select the combination <ul style="list-style-type: none"> • Normal: Standard combination method. This compensates the brightness so that dark sections on the combination image do not become all black. • Color: This is suitable for inspecting labeling and the Gravity and Area. This compensates the saturation when there is little hue information in the combined image. • Linear: This is suitable for fine matching and defect inspection. In order to output the actual brightness of the workpiece, no correction is applied.

1-5-4 Bright Adjust Setting (Camera Image Input HDR (using FHV Controller))

This sets how far to track the brightness of the images to load.

- 1 In the Item tab area, click **Bright adjust**.
- 2 Set each item in the *Bright adjust setting* area.
When placing a check at the *Bright adjust*, the Brightness Adjustment range is displayed with blue lines in the *Histogram* area.
Change the *Adjust bright ave.* and *Brightness adjust area* as necessary.

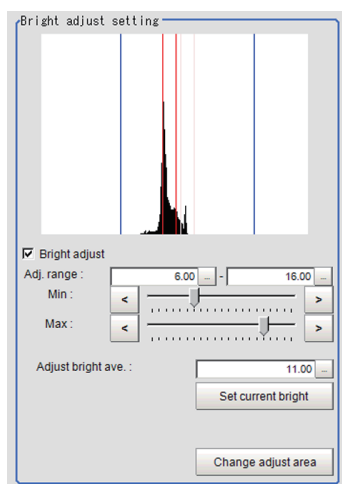

Setting item	Setting value [Factory default]	Description
Bright adjust	<ul style="list-style-type: none"> • Checked • [Unchecked] 	When placing a check at <i>Bright adjust</i> , the image is output with its brightness automatically compensated. This makes it possible to obtain images with stable brightness even if the lighting condition fluctuates, for example, due to interfering light.
Min. Adj range	0.00 to 20.00 [6.00]	Specify the follow-up brightness minimum value.
Max. Adj range	0.00 to 20.00 [16.00]	Specify the follow-up brightness maximum value.

Setting item	Setting value [Factory default]	Description
Adjust bright ave.	0.00 to 20.00 [11.00]	Specify the target for brightness follow-up. Clicking the Set current bright updates this value.

1-5-5 Lens Adjustment (Camera Image Input HDR (using FHV Controller))

Sets the focus for lens module.

- 1 In the Item tab area, click **Lens adjustment**.
- 2 In the *Common setting for all cameras* area, set the *Camera adjust* area.

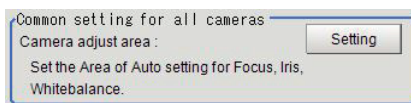

- 3 In the *Lens adjustment* area, specify a value for the *Focus*.



Setting item	Setting value [Factory default]	Description
Focus	FHV-LEM-S06: 26 to 260 [50] FHV-LEM-S09: 18 to 480 [50] FHV-LEM-S12: 47 to 815 [50] FHV-LEM-S16: 10 to 685 [50] FHV-LEM-S25: 37 to 885 [50] FHV-LEM-H06/FHV-LEM-H19 : 0 to 1,023 [50]	Sets the focus value.
Automatic	-	This is used to set the focus value automatically. (Autofocus) ^{*1} Sets the <i>Focus</i> automatically to the <i>Camera adjust area</i> in the <i>Common setting for all cameras</i> .

*1. The time for automatic focus adjustment varies depending on the initial value, range, and adjustment area, also camera settings and lighting settings.

1-5-6 External Reference Tables (Camera Image Input HDR (using FHV Controller))

No.	Data name	Data ident	Set/Get	Data range
10000	Judge	judge	Get only	0: No judgment (unmeasured), 1: Judgment result OK, -1: Judgment result NG, -10: Error (image format mismatch), -11: Error (unregistered model), -12: Error (insufficient memory), -20: Error (other errors)
None	Modulate mode	lightGainMode	Set/Get	It represents the dimming method for each Part with the sum of 4-bit units. 0: Duty, 1: Voltage and Current. Example: When Part 0, Part 2, and Part 5 are set to Voltage and Current: 1048833
None	Lighting control(Site List)	lightGain	Set/Get	A representation of a lighting brightness of each Part in hexadecimal. A value of Part 0 to Part 7 is presented from left to right. Example: When the illumination brightness of Part 0 to Part 3 was set to 255 (ff): ffffffff00000000
None	On all the time	alwaysLight	Set/Get	0: OFF, 1: ON
None	CH	lightEnabledChannel	Set/Get	0: OFF, 1: ON
None	Follow-up brightness average	brightAverage	Set/Get	
None	The presence or absence of brightness follow-up	adjustBright	Set/Get	0: OFF, 1: ON
None	Combine type	combineMode	Set/Get	0: Normal, 1: Color, 2: Linear
None	The maximum follow-up range	maxAdjustBright	Set/Get	
None	The minimum follow-up range	minAdjustBright	Set/Get	
None	White balance B	whiteBalanceB	Set/Get	
None	White balance G	whiteBalanceG	Set/Get	
None	Binning setting	binningY	Set/Get	0: One line, 1: Two line
None	Calibration parameter	calibParameter	Set/Get	A B C D E F separated by ","
None	White balance R	whiteBalanceR	Set/Get	
None	Focus	focus	Set/Get	
None	Zoom	zoom	Set/Get	
None	Iris base density	irisDensity	Set/Get	
None	Iris	iris	Set/Get	
None	End line	endY	Set/Get	
None	Start line	startY	Set/Get	

No.	Data name	Data ident	Set/Get	Data range
None	STEP - STGOUT delay	strobeDelay	Set/Get	
None	STGOUT selection	stgoutSelect	Set/Get	0: Same as the camera input, 100 + N: N is the camera number.
None	Mirror an image(←→)	reverseX	Set/Get	0: OFF, 1: ON
None	Camera model	cameraModel	Set/Get	Connectable camera model name
None	Camera No.	cameraNo	Set/Get	
None	Mirror an image(↑↓)	reverseY	Set/Get	0: OFF, 1: ON
None	Gain	gain	Set/Get	
None	Lightness width	hcBrightRange	Set/Get	
None	Average brightness	hcAveBright	Set/Get	
None	Input num set(Num-ber of sheets)	shutterNum	Set/Get	
None	Input num set(Ena-bled)	setShutterNum	Set/Get	0: OFF, 1: ON
None	The maximum bright-ness	maxBright	Set/Get	
None	STGOUT polarity	pulsePolarity	Set/Get	0: Negative, 1: Positive
None	STGOUT width	pulseWidth	Set/Get	
None	Minimum brightness	minBright	Set/Get	
None	Mode select	highContrastMode	Set/Get	0: HDR mode, 1: High contrast mode

1-6 Camera Image Input HDR Lite

This processing item is specialized for FZ-SQ □□□□.

You can acquire a wide dynamic range image by combining images photographed consecutively at different shutter speeds.

With objects that generate halation, images with low-contrast, and environments with fluctuation in the lighting, this processing item is an effective substitute for Camera Image Input.

Used in the Following Case

- To acquire stable images of objects for which halation occurs easily.

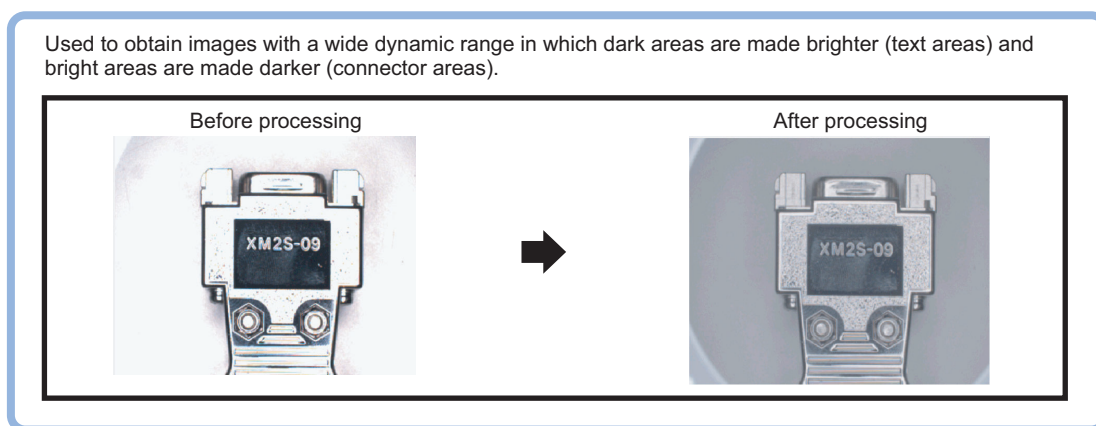

Precautions for Correct Use

- Camera Image Input FH is preset for Unit 0. Do not set any processing item other than camera image input (Camera Image Input FH, Camera Image Input HDR, Camera Image Input HDR Lite, Photometric Stereo Image Input) for Unit 0.
- For this processing item, do not use scene variables or system-defined variables as parameters.
- Just after starting up the Sensor Controller or just after changing scenes, it becomes no image input. In this state, it is set to the same color image processing as in the factory default state.
- When the *Properties* dialog box is opened with no image input, click the **Cancel** button to close the dialog box. Pressing the **OK** button in the dialog box will change the setting to the same color camera setting as the factory default state.
For details, *FAQ - For Measurement - The measurement NG (image mismatch) error will result when connecting a monochrome camera in the Vision System FH/FHV Series User's Manual* (Cat. No. Z365).

1-6-1 Settings Flow (Camera Image Input HDR Lite)

To set Camera Image Input HDR Lite, follow the steps below.

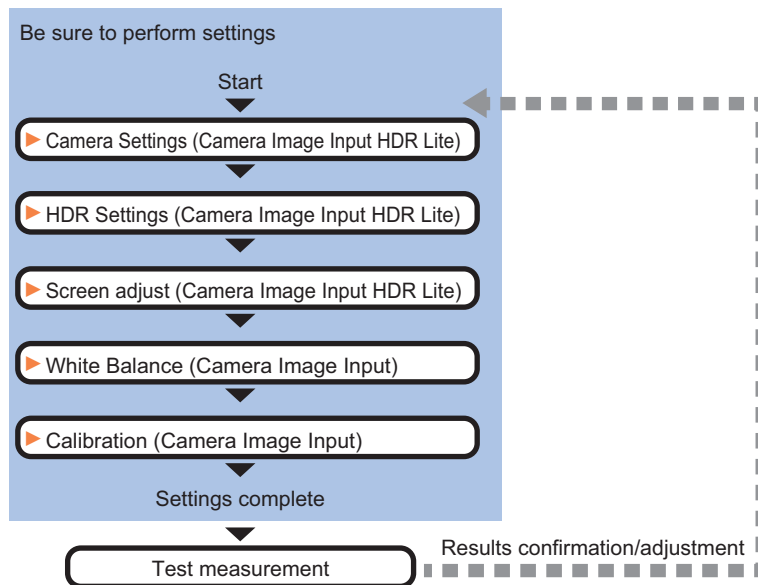

List of Camera Image Input HDR Lite Items

Item	Description
Camera settings	Specify the camera settings such as the electronic flash. <i>1-6-2 Camera Settings (Camera Image Input HDR Lite) on page 1-118</i>
HDR setting	Specify the dynamic range and brightness settings. Specify the HDR automatic setting as necessary. <i>1-6-3 HDR Settings (Camera Image Input HDR Lite) on page 1-118</i>
Screen adjust	Adjust images with or without the light adjustment or using display line bright. <i>1-6-4 Screen Adjust (Camera Image Input HDR Lite) on page 1-119</i>
White balance	When using a color camera, adjust the white balance. The setting method is the same as for Camera Image Input. Please check it.
Calibration	Set when measurements (camera coordinate measurement values) are to be output using actual dimensions. Select the calibration setting method and generate the calibration parameters. The setting method is the same as for Camera Image Input. Please check it.

1-6-2 Camera Settings (Camera Image Input HDR Lite)

Set the following photographing conditions

- *Selection Setting* on page 1-118
- *Number of Lines to be Read* on page 1-9
- *Electronic Flash Setting* on page 1-98

Selection Setting

When multiple cameras are connected, select the camera to use for measurement.

- 1 In the Item tab area, click **Camera setting**.

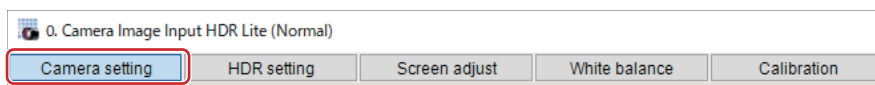

- 2 Click ▼ on the right of the *Camera No.* and select the camera number.

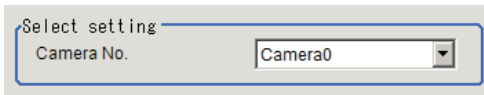

Setting item	Setting value [Factory default]	Description
Camera No.	Camera 0 to 7 [Camera 0]	Select the camera number.

1-6-3 HDR Settings (Camera Image Input HDR Lite)

Specify the dynamic range and brightness settings.

- 1 In the Item tab area, click **HDR Setting**.
- 2 When clicking **Auto**, the *Dynamic Range* and *Brightness* will be automatically set. If this does not work, manually adjust the *Dynamic Range* and *Brightness* in the *HDR setting* area.

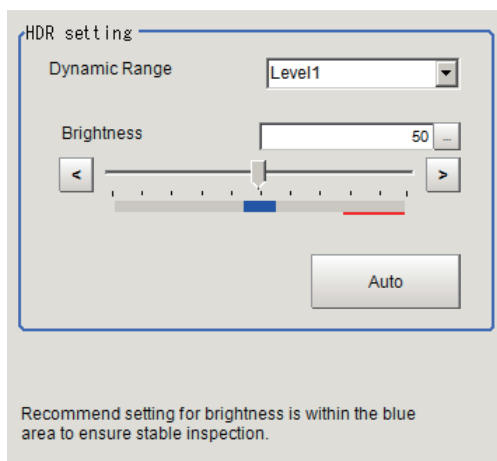

Setting item	Setting value [Factory default]	Description
Dynamic Range	Level 1 to 4	Specify the dynamic range. The larger the value is, the broader the dynamic range to be combined will be.
Brightness	1 to 100	Specify the brightness settings. The larger the value is in this setting, the longer the exposure time will be. When using a high-speed line, check to make sure that there is no image blur in an actual environment. The degree of image blur can be lowered by decreasing the brightness even when the movement speed of the object is fast.

• Correlation between the level and the dynamic range

The larger the value of the level is, the larger the dynamic range to be combined will be, as illustrated below.



Precautions for Correct Use

For stable operations, we recommend setting the brightness within the range where the blue bar does not enter the red region. Measurement values may be different if the recommended range is exceeded. Be sure to thoroughly check the measurement result and set the brightness value.

1-6-4 Screen Adjust (Camera Image Input HDR Lite)

Specify the camera image input HDR Lite lighting and the line bright display settings. Specify whether or not to use the lighting. The setting method for line bright is the same as for Camera Image Input. For details, refer to *Line Bright* on page 1-18.

1 In the Item Tab area, click **Screen adjust**.

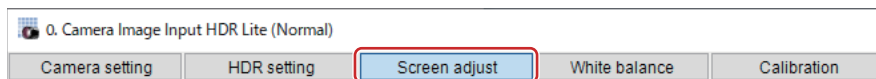

2 Set *Lighting control* as necessary.

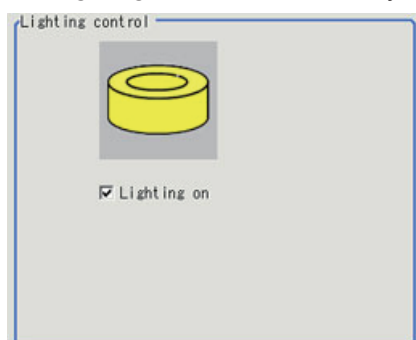

Setting item	Setting value [Factory default]	Description
Lighting on	<ul style="list-style-type: none"> • [Checked] • Unchecked 	Unchecks the checkbox when no lighting is used.

1-6-5 External Reference Tables (Camera Image Input HDR Lite)

No.	Data name	Data ident	Set/Get	Data range
10,000	Judge	judge	Get only	0: No judgment (unmeasured), 1: Judgment result OK, -1: Judgment result NG, -10: Error (image format mismatch), -11: Error (unregistered model), -12: Error (insufficient memory), -20: Error (other errors)
None	CH	lightEnabledChannel	Set/Get	0: OFF, 1: ON
None	On all the time	alwaysLight	Set/Get	0: OFF, 1: ON
None	Lighting control (Site List)	lightGain	Set/Get	A representation of a lighting brightness of each Part in hexadecimal. A value of Part 0 to Part 7 is presented from left to right. Example: When the illumination brightness of Part 0 to Part 3 was set to 255 (ff): ffffffff00000000
None	Modulate mode	lightGainMode	Set/Get	It represents the dimming method for each Part with the sum of 4-bit units. 0: Duty, 1: Voltage and Current. Example: When Part 0, Part 2, and Part 5 are set to Voltage and Current: 1048833
None	White balance R	whiteBalanceR	Set/Get	
None	Calibration parameter	calibParameter	Set/Get	A B C D E F separated by ","
None	Binning setting	binningY	Set/Get	0: One line, 1: Two line
None	White balance G	whiteBalanceG	Set/Get	
None	White balance B	whiteBalanceB	Set/Get	
None	End line	endY	Set/Get	
None	STGOUT selection	stgoutSelect	Set/Get	0: Same as the camera input, 100 + N: N is the camera number.
None	Camera No.	cameraNo	Set/Get	
None	Start line	startY	Set/Get	
None	STEP - STGOUT delay	strobeDelay	Set/Get	
None	Dynamic Range	drLevel	Set/Get	0: Level1, 1: Level2, 2: Level3, 3: Level4
None	Brightness	brightValue	Set/Get	
None	STGOUT width	pulseWidth	Set/Get	

No.	Data name	Data ident	Set/Get	Data range
None	STGOUT polarity	pulsePolarity	Set/Get	0: Negative, 1: Positive

1-7 Photometric Stereo Image Input (using FH Controller)

This processing item cannot be used correctly unless the Photometric Stereo lighting controller (FLTCC1PS) is connected.

Set the conditions for loading images from the camera and for storing images of the measured objects. This processing item must be used when measuring.

With the use of Photometric Stereo lighting, images lit from different directions can be filtered to extract Shape images (to reveal surface unevenness defects such as dents) and Texture images (for better character and pattern recognition).

When using the FHV Controller, refer to *1-8 Photometric Stereo Image Input (using FHV Controller)* on page 1-144.



Precautions for Correct Use

- When setting this processing item with logged images, logged images are required in a state that the multiple times captured image logging is set to **Yes** in the image logging. For details, refer to *Logging Measurement Values and Measurement Images [Data Logging / Image Logging]* in the *Vision System FH/FHV Series User's Manual (Cat. No. Z365)*.
 - When using this processing item, install cameras and lightings to observe the following issues.
 - The cameras and lightings should be installed in nearly parallel with the imaging target.
 - Lightings should be installed so that the imaging target is located in the center of a ring type lighting.
 - For this processing item, do not use scene variables or system-defined variables as parameters.
-

Used in the Following Case

When you want to detect unevenness defects.

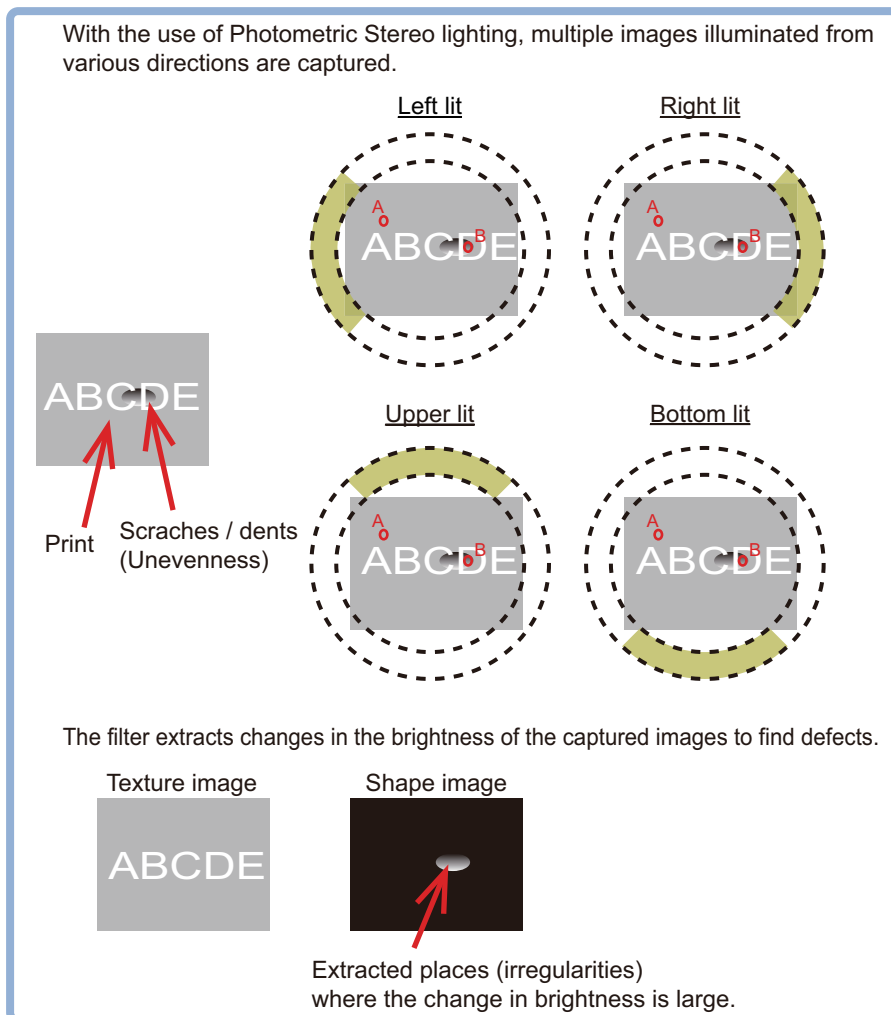

Precautions for Correct Use

- Camera Image Input FH is preset for Unit 0. Do not set any processing item other than camera image input (Camera Image Input FH, Camera Image Input HDR, Camera Image Input HDR Lite, or Photometric Stereo Image Input) for Unit 0.
- When switching from a color camera to a monochrome or switching to a camera with a different resolution, reconfigure the settings in the units that follow it in the flow.
- If a camera is connected other than the one for the previous settings, the camera settings are returned to their initial settings.
- Immediately after starting up the Sensor Controller and immediately after changing scenes, there will be no input image. No input image is processed as the same color image as in the factory default state.
- If you open the *Properties* dialog Box before inputting an image, click **Cancel** to close the dialog box. Clicking **OK** in the dialog box will change the setting to the same color camera setting as the factory default setting.

For details, refer to *FAQ For Measurement The measurement NG (image mismatch) error will result when connecting a monochrome camera in the Vision System FH/FHV Series User's Manual (Cat No. Z365).*

1-7-1 Settings Flow (Photometric Stereo Image Input (using FH Controller))

To set Photometric Stereo Image Input (using FH Controller), follow the steps below.

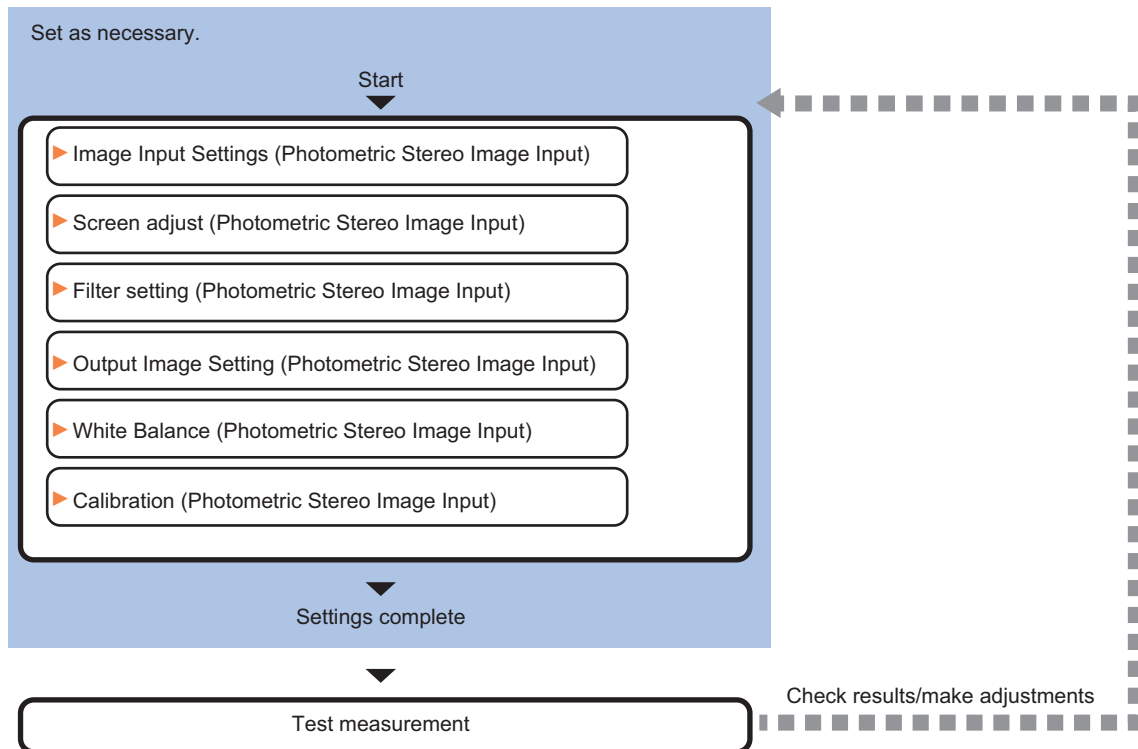

List of Photometric Stereo Image Input Items

Item	Description
Image input settings	Set related to cameras and lightings. <i>1-7-2 Image Input Settings (Photometric Stereo Image Input (using FH Controller))</i> on page 1-125
Screen adjust	Specify the Photometric Stereo Lighting settings. <i>1-7-3 Screen Adjust (Photometric Stereo Image Input (using FH Controller))</i> on page 1-133
Filter setting	Specify the Photometric Stereo image filter parameters. <i>1-7-4 Filter Setting (Photometric Stereo Image Input (using FH Controller))</i> on page 1-138
Output image setting	Set the image to be output to the subsequent stage in the processing flow from among the images created by this filter. <i>1-7-5 Output Image (Photometric Stereo Image Input (using FH Controller))</i> on page 1-141
White balance	When using a color camera, adjust the white balance. The setting method is the same as for Camera Image Input. Please check it. <i>1-7-6 White Balance (Photometric Stereo Image Input (using FH Controller))</i> on page 1-142

Item	Description
Calibration	Set when measurements (camera coordinate measurement values) are to be output using actual dimensions. Select the calibration setting method and generate the calibration parameters. The setting method is the same as for Camera Image Input. Please check it. <i>1-7-7 Calibration (Photometric Stereo Image Input (using FH Controller))</i> on page 1-142
Camera model	The camera model currently connected can be checked. <i>1-7-8 Camera Model (Photometric Stereo Image Input (using FH Controller))</i> on page 1-142

1-7-2 Image Input Settings (Photometric Stereo Image Input (using FH Controller))

Set the following photographing conditions



Additional Information

The display items differ depending on the camera model and lighting mode. Perform the setting with the following procedures according to the usage environment.

Display

Switches the display in the Image area.

- 1 In the Item tab area, click one of the tabs.
Any item tab can set this.

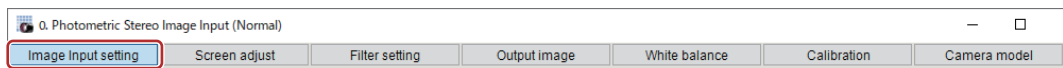

- 2 Click **Change display** to select the type of camera image.
The display in the *Image display* area will switch.

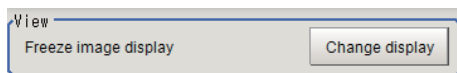

Setting item	Setting value [Factory default]	Description
Display	<ul style="list-style-type: none"> • Through image • [Freeze image] 	<ul style="list-style-type: none"> • Through image: The latest image is always loaded from the camera and displayed. • Freeze image: The image loaded in the immediately preceding measurement is displayed.

Select Settings

When multiple cameras are connected, select the camera to use for measurement.

- 1 In the Item tab area, click **Image input setting**.

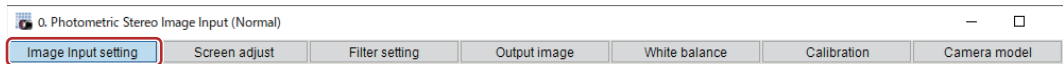

- 2 Click ▼ on the right of the *Camera No.* and select the camera number.

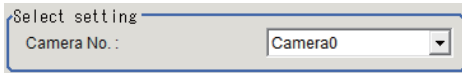

Setting item	Setting value [Factory default]	Description
Camera No.	Camera 0 to 7 [Camera 0]	Select the camera number.

Camera Settings

Adjust the settings related to camera shutter speed and camera gain.

Set the shutter speed appropriate to the speed of the measurement object. Choose a faster shutter speed if the measurement object is moving quickly and the image is blurred.

Adjust the camera gain when images cannot be brightened through the shutter speed, lens aperture, or lighting conditions. Usually, the factory default values can be used.

Example:

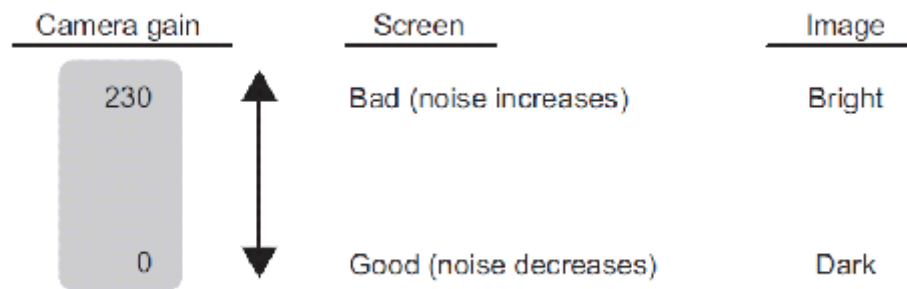

(Factory default: 85)

- 1 In the Item tab area, click **Image input setting**.

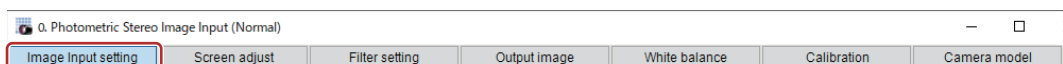

- 2 In the *Camera settings* area, specify the shutter speed.

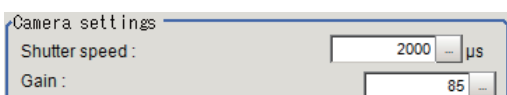

Setting item	Setting value [Factory default]	Description
Shutter speed	FZ-SC/FZ-S/FZ-SHC/FZ-SH 20 to 100,000 [μ s] [2,000] FZ-SC2M/FZ-S2M/FZ-SC5M <input type="checkbox"/> /FZ-S5M <input type="checkbox"/> /FZ-SF <input type="checkbox"/> /FZ-SP <input type="checkbox"/> 20 to 100,000 [μ s] [8,333] FH-SC02/FH-SM02/FH-SC04/FH-SM04 25 to 100,000 [μ s] [2,000] FH-SC05R/FH-SM05R 500 to 100,000 [μ s] (by 50 μ s unit) [8,000] FH-SC12/FH-SM12 60 to 100,000 [μ s] [12,000] FH-S <input type="checkbox"/> X/FH-S <input type="checkbox"/> X01/FH-S <input type="checkbox"/> X03/FH-S <input type="checkbox"/> X05/FH-S <input type="checkbox"/> X12 1 to 100,000 [μ s] [2,000] <i>Camera Settings</i> on page 1-126 FH-S <input type="checkbox"/> 21R 50 to 100,000 [μ s] [2,000] <i>Camera Settings</i> on page 1-126	The <i>shutter speed</i> value to set depends on a camera type.

- *1. Note that the shortest shutter speed for FH-S X12 is below.
 Settable value on the screen: 1 [μ s]
 Actual shutter speed: 1.5 [μ s]
- *2. When using FH-S 21R in the reset mode: the rolling shutter, the actual shutter speed for the setting value on the screen is rounded and reflected in the actual operation.
 Note that the reflected operation differs as follows by the number of camera cables and the communication speed setting.
- 1 camera cable & standard communication speed: Multiple of 46.9 [μ s]
 - 1 camera cable & high communication speed: Multiple of 22.3 [μ s]
 - 2 camera cables & standard communication speed: Multiple of 23.5 [μ s]
 - 2 camera cables & high communication speed: Multiple of 11.2 [μ s]
- For example, when the shutter speed is set to 2,000 [μ s], the actual shutter speed is as follows.
- 1 camera cable & standard communication speed: 1,969.8 [μ s] (42 times of 46.9 [μ s])
 - 1 camera cable & high communication speed: 1,984.7 [μ s] (89 times of 22.3 [μ s])
 - 2 camera cables & standard communication speed: 1,997.5 [μ s] (85 times of 23.5 [μ s])
 - 2 camera cables & high communication speed: 1,993.6 [μ s] (178 times of 11.2 [μ s])

3 Specify the camera gain while checking the image.

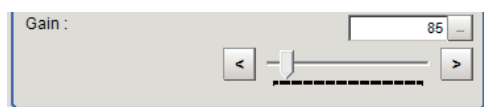

Setting item	Setting value [Factory default]	Description
Camera gain	FZ-SC/FZ-S/FZ-SHC/FZ-SH 0 to 230 [85] FZ-SC2M/FZ-S2M/FZ-SC5M <input type="checkbox"/> /FZ- S5M <input type="checkbox"/> /FZ-SF <input type="checkbox"/> /FZ-SP <input type="checkbox"/> 0 to 230 [50] FZ-SC5M3 0 to 230 [65] FH-SC02/FH-SM02/FH-SC04/FH-SM04 0 to 255 [0] FH-SC12/FH-SM12 0 to 255 [0] FH-SC05R/FH-SM05R 0 to 63 [0] FH-S <input type="checkbox"/> X/FH-S <input type="checkbox"/> X01/FH-S <input type="checkbox"/> X03/FH-S <input type="checkbox"/> X05/FH-S <input type="checkbox"/> X12 0 to 240 [0] FH-S <input type="checkbox"/> 21R 0 to 200 [0]	Adjusts the <i>Camera gain</i> when the shutter speed, the lens aperture, and lighting conditions cannot be used to brighten the image. Usually, the factory default value can be used.



Precautions for Correct Use

- Due to the specification of its imaging elements, a CMOS camera generates stripe noises when the gain setting of the camera is raised. You may also find multiple defective pixels, but they do not represent a defect or failure of the product in any way. If stripe noises and defective pixels affect the measurement results, lower the gain setting of the camera or use a CCD camera.

Reset Mode (only for FH-SC05R/FH-SM05R)

In Photometric Stereo Image Input, the Reset mode for a Rolling shutter camera is Rolling shutter.

- Reset mode:

Rolling Shutter: Use this mode when capturing static objects.

Global Reset: Use this mode when capturing moving objects.

For details, refer to *Reset Mode (FH-SC05R/FH-SM05R/FH-SC21R/FH-SM21R only)* on page 1-34.

Number of Lines to be Read

By narrowing the image range to be loaded, the image scan time can be shortened.

Set the range taking the offset of the measurement object into consideration.

The part of the image narrowed down by the start line and the end line will be displayed in the setting screen of the processing item window and the Image Display area of the Main screen.

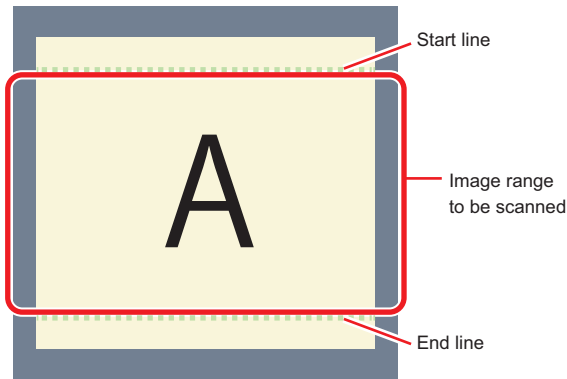

Additional Information

About minimum number of lines:

- For FH-SM □□/ FH-SM □□ R, the minimum number of lines (minimum value between the start and end lines) is 4 lines.
- For FH-SC □□/ FH-SC □□ R, the minimum number of lines is 4 lines.
- For FZ-S □ 5M3, the minimum number of lines is 4 lines.
- For FZ-S □ 5M3, the step width of the start line and end line is 4 lines.
When loading a scene created with FZ-S □ 5M2, the number of loading lines will increase up to 4 lines.

About coordinate values:

- The coordinate values displayed as the measurement results are the values of the display position on the monitor.
- The coordinate values do not vary according to the settings for "Number of lines to be read".

- 1 In the Item tab area, click **Image input setting**.

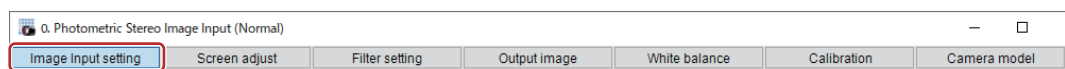

- 2 Set the start and end lines in the *Number of Lines to be Read* area.

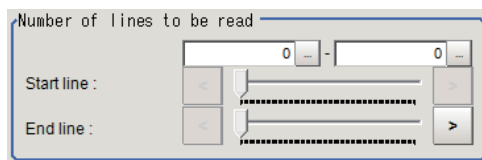

Electronic Flash Setting

This function is set when an electronic flash is used. This sets the output conditions for the signal to synchronize the measurement and the electronic flash timing.



Precautions for Correct Use

- The STGOUT signals that can be output are as follows.
 - FH-2000/FH-5000 series: SGTOOUT 0 to 7
 - FH-L series: STGOUT 0 to 3
- STGOUT0 to STGOUT7 is tied to the camera connector number of the sensor controller, not the camera number. When you use CameraLink Medium Configuration or the Multi-line random-trigger mode, confirm the camera connector number that corresponds to the camera number of Sensor Controller.

- In the Item tab area, click **Image input setting**.

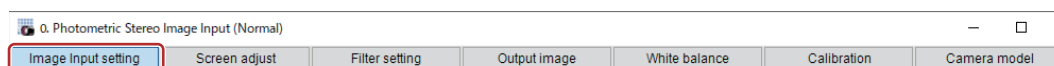

- In the *Electronic flash setting* area, specify each item.

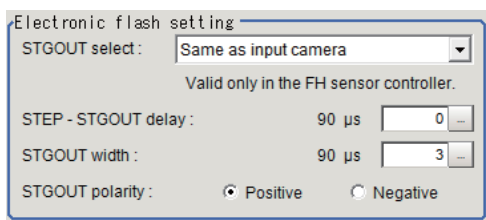

Setting item	Setting value [Factory default]	Description
STGOUT select	[Same as the input camera] Camera 0 to 7	Select the STGOUT sGain <ul style="list-style-type: none"> Same as the input camera: STGOUT that is tied to the input camera is output. Camera 0 to 7: STGOUT signal that is tied to the selected camera is output.
STEP-STGOUT delay	0 to 511 [0] (1 count: 30 [μs])	Sets the waiting time from the time the start of this camera image input processing item until the electronic flash trigger output signal comes ON. Delay time = Count × 30 μs + 90 μs The delay time varies depending on the <i>polarity of STGOUT pulse</i> . The displayed time is for the positive polarity. Add 35 [μs] to the displayed time when the polarity is negative. The display time becomes within a range of ±10 [μs] to the setting value.
STGOUT width	0 to 43,689 [3] (1 count: 30 [μs])	Sets the output time for the electronic flash trigger signal. If 0 is set, the electronic flash will not flash.

Setting item	Setting value [Factory default]	Description
STGOUT polarity	<ul style="list-style-type: none"> [Positive] Negative 	<p>Selects the pulse polarity of the electronic flash trigger.</p> <ul style="list-style-type: none"> Positive polarity Flashes synchronized with the timing of the electronic flash trigger output signal changing from OFF to ON. Negative polarity Flashes synchronized with the timing of the electronic flash trigger output signal changing from ON to OFF.



Precautions for Correct Use

Do not perform next camera image input processing before STGOUT signal output is completed. The STGOUT signal may not be output. Perform camera image input processing by checking the STGOUT signal output completion, or properly adjust the STEP-camera delay, STEP-STGOUT delay and STGOUT pulse width so that the electronic flash operates synchronizing with the exposure time.

Input Time

You can verify the Input time. The time required for image input and filter processing is displayed.

- 1 In the Item tab area, click **Image input setting**.



- 2 The Input time is displayed.

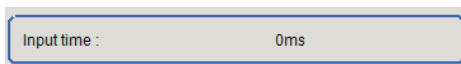

Display Setting

You can change how it is displayed.

- 1 In the Item tab area, click **Image input setting**.

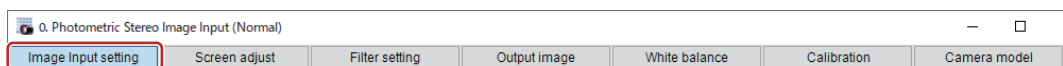

- 2 Select the image to display in the *Display setting* area.
The applicable settings are reflected in the *Image display* area of the processing item.

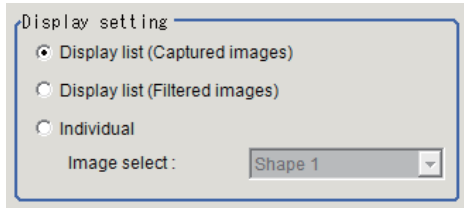

Setting item	Setting value [Factory default]	Description
Display settings	<ul style="list-style-type: none"> • [Display lists (Captured images)] • Display list (Filtered images)] • Individual 	The applicable settings are displayed in the <i>Image display</i> area of the processing item. *1
Select image	<ul style="list-style-type: none"> • [Shape 1] • Shape 2 • Shape 3 • Texture • Full lighting • Captured image 1 • Captured image 2 • Captured image 3 • Captured image 4 • Captured image 5 • Captured image 6 • Captured image 7 • Captured image 8 	Select an image to display when Individual is set for the Display setting.

*1. **Display list (Captured images):**
The captured image and full lighting image is displayed

Selected Input pattern is Four

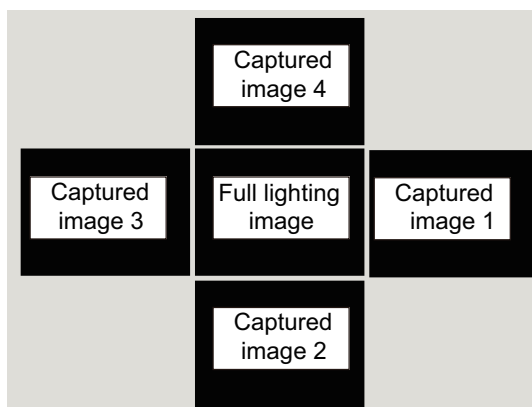

Selected Input pattern is Eight

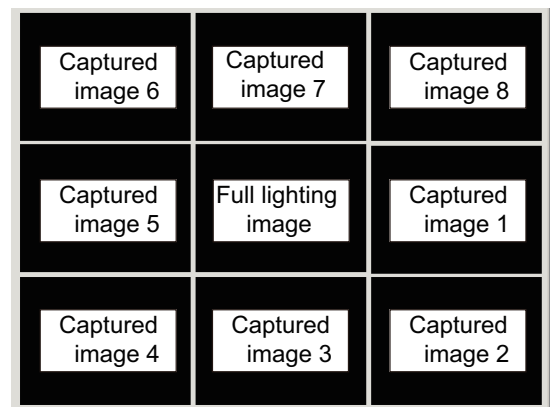

Displayed list (Filtered images):
Displays the Shape images and Texture images.

Individual

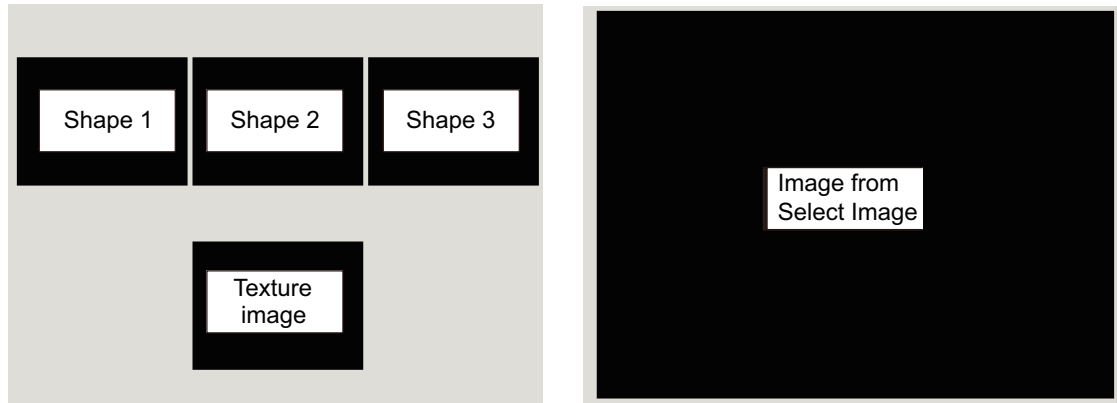

1-7-3 Screen Adjust (Photometric Stereo Image Input (using FH Controller))

Set the conditions for the Photometric Stereo lighting.

Input Settings

You can select the Input pattern for the connected Photometric Stereo lighting.

- 1 In the Item tab area, click **Screen adjust**.



- 2 In the *Input settings* area, select the Input pattern to use.

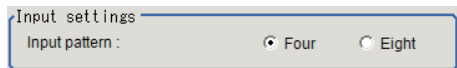

Setting item	Setting value [Factory default]	Description
Input pattern	<ul style="list-style-type: none"> • [Four] • Eight 	Select the <i>Input pattern</i> for Photometric Stereo lighting to use for image capture. <ul style="list-style-type: none"> • Four: Illuminate from 4 directions and capture 4 images. • Eight: Illuminate from 8 directions and capture 8 images.

The applicable settings are reflected in the *Image display* area of the processing item.

Input pattern: Four

Input pattern: Eight

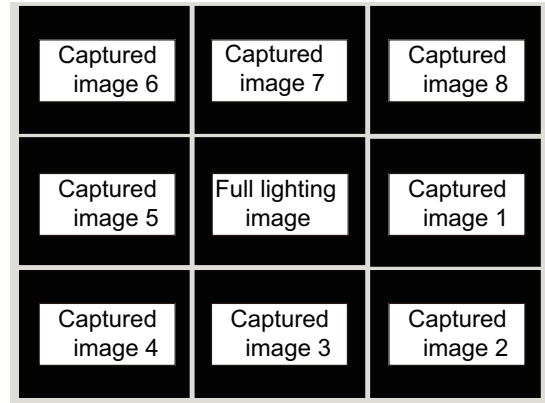
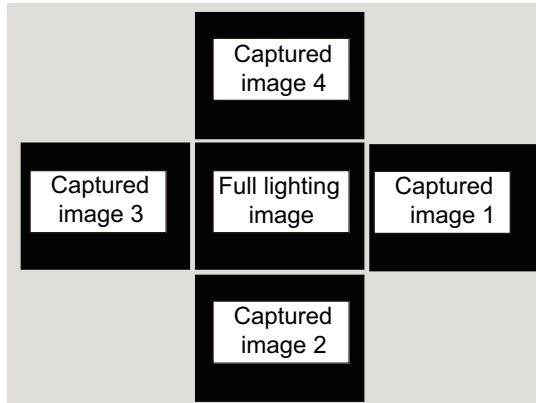

Lighting Control Settings

You can adjust the connected Photometric Stereo lighting settings from the FH Controller. You can adjust not only the illuminating width and intensity of the lighting but also the illuminating direction.

- 1 In the Item tab area, click **Screen adjust**.

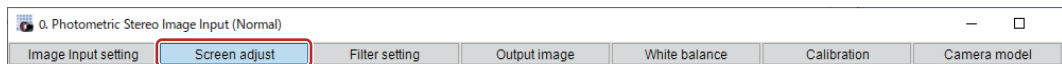

- 2 In the *Lighting control* area, adjust the settings for the Photometric Stereo lighting.

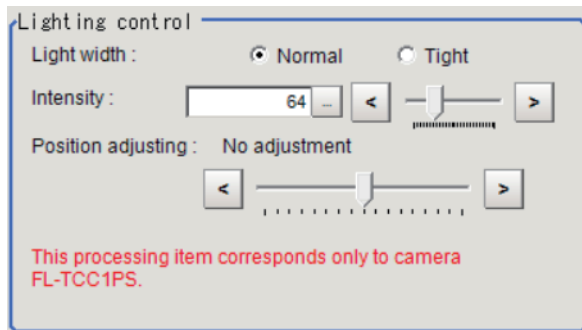

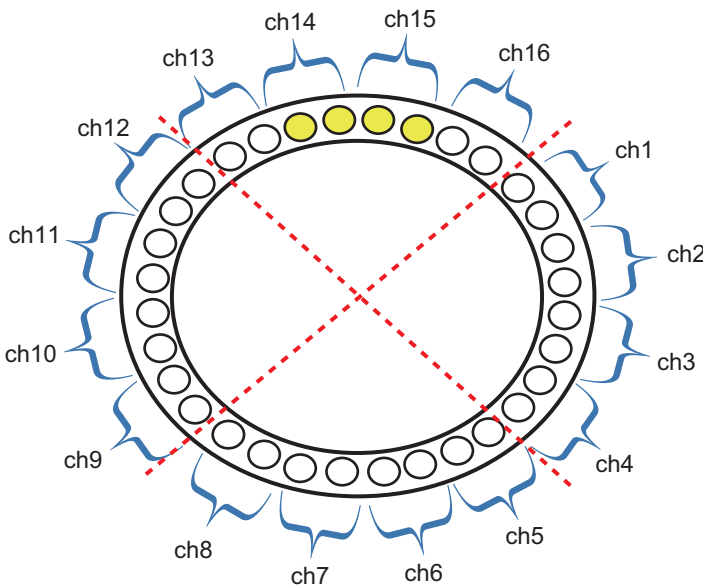
Setting item	Setting value [Factory default]	Description
Light width	<ul style="list-style-type: none"> • [Normal] • Tight 	<p>Select the width of the area to illuminate.</p> <ul style="list-style-type: none"> • Normal: For image capture in one direction, four channels emit light. When the <i>Input pattern</i> is <i>Four</i>, the light emitting position moves clockwise by 4ch at a time. When the <i>Input pattern</i> is <i>Eight</i>, the light emitting position moves clockwise by 2ch at a time. • Tight: Four image capture in one direction, 2 channels emit light. Use this setting when there is a high degree of halation. When the <i>Input pattern</i> is <i>Four</i>, the light emitting position moves clockwise by 4ch at a time. When the <i>Input pattern</i> is <i>Eight</i>, the light emitting position moves clockwise by 2ch at a time. 
Intensity	0 to 255 [64]	Set the intensity of the lighting.

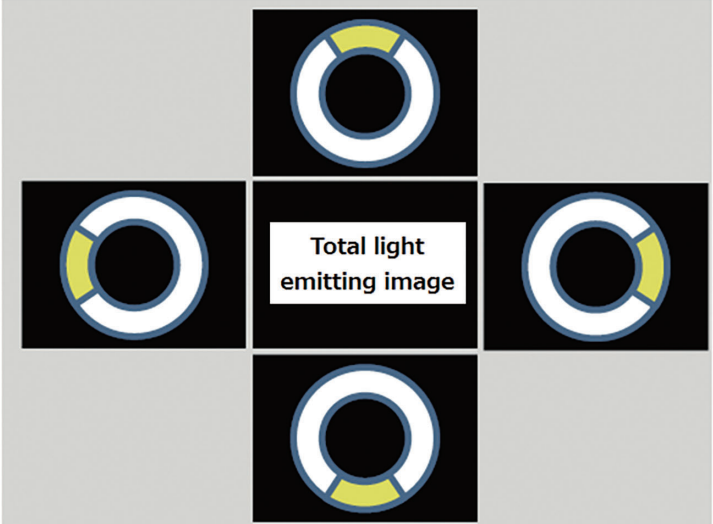
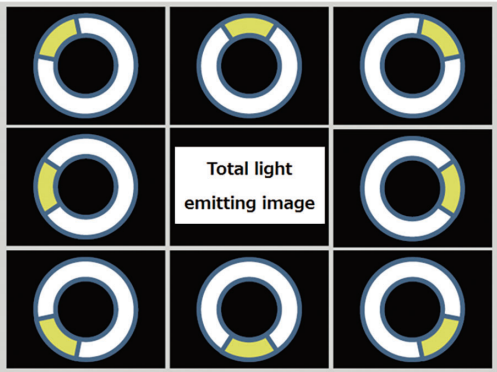
Setting item	Setting value [Factory default]	Description
Position adjustment	<ul style="list-style-type: none"> • CCW 180° • CCW 157.5° • CCW 135° • CCW 112.5° • CCW 90° • CCW 67.5° • CCW 45° • CCW 22.5° • [No adjustment] • CW 22.5° • CW 45° • CW 67.5° • CW 90° • CW 112.5° • CW 135° • CW 157.5° • CW 180° 	<p>You can shift the illuminating position of the lighting. Shown below figure, adjust so that the display position of the screen and the lighting position of the lighting match. <i>Input pattern: Four - Lighting illuminating position</i></p>  <p><i>Input pattern: Eight - Lighting illuminating position</i></p> 

Line Bright

The graph showing the gray distribution for one line in the image is called the *Line Bright*. you can play the line brights for R, G, and B for any horizontal or vertical line.

- 1 In the Item tab area, click **Screen adjust**.

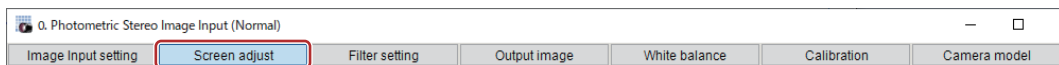

- 2 In the *Display setting* area, select *Individual*.

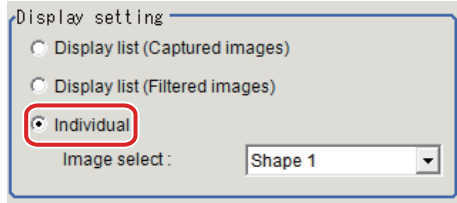

3 In the *Line bright* area, place a check in the check box for *Display line bright*.

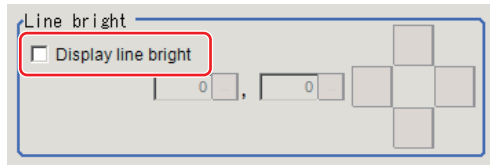

4 Move the line to the position whose density distribution you want to see.

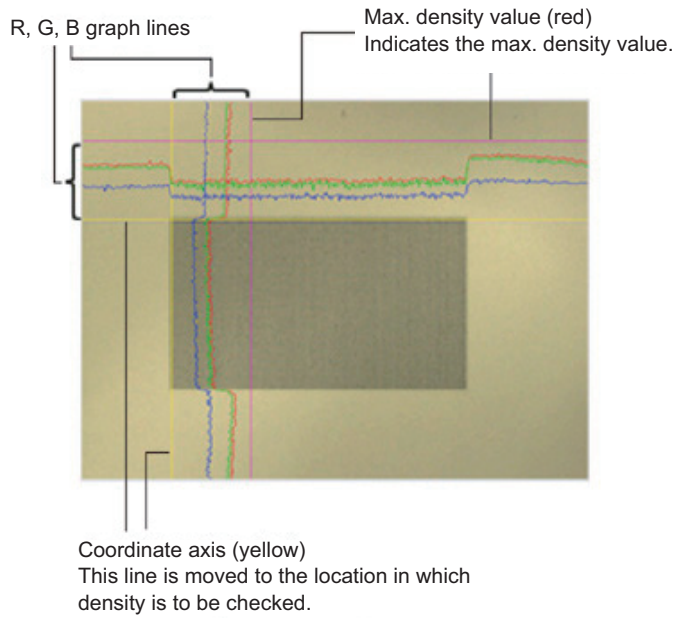

1-7-4 Filter Setting (Photometric Stereo Image Input (using FH Controller))

Adjust the Photometric Stereo image filter parameters.

Shape 1, Shape 2, Shape 3

You can set the filter parameters for a Photometric Stereo image captured as a Shape image. You can analyze the change in magnitude of brightness from the captured Photometric Stereo image and can extract defects as Shape images.

- 1 In the Item tab area, click **Filter setting**.
Display of one row is added under the tab area.

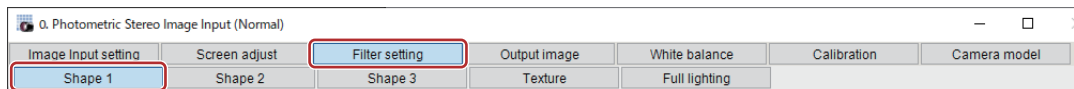

- 2 In the Item tab area, select **Shape 1**, **Shape 2**, or **Shape 3**.
- 3 In the *Display setting* area, you can toggle the display between Shape image and Display gradient image.
In the Gradient image, you can check whether the defect you want to detect (emphasis) is visible for the captured image.
The image is the result of calculating the degree of brightness change on the X slope in the horizontal direction and the Y slope in the vertical direction.
The Gradient image is not linked with the parameters used in the Setting area.

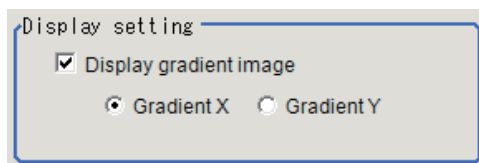

Setting item	Setting value [Factory default]	Description
Display gradient image	<ul style="list-style-type: none"> • Checked • [Unchecked] 	<ul style="list-style-type: none"> • Checked: A gradient image is displayed. • Unchecked: A Shape image is displayed.
Gradient image type	<ul style="list-style-type: none"> • [Gradient X] • Gradient Y 	Set this when displaying a Gradient image. <ul style="list-style-type: none"> • Gradient X: Image obtained as a result of calculating the degree of change in brightness in the horizontal direction. • Gradient Y: Image obtained as a result of calculating the degree of change in brightness in the vertical direction. When unchecking <i>Display gradient image</i> , this function is disabled.

- 4 In the *Settings* area, adjust the parameters for a Shape image.

Click **Detail setting** to set more parameters as necessary.

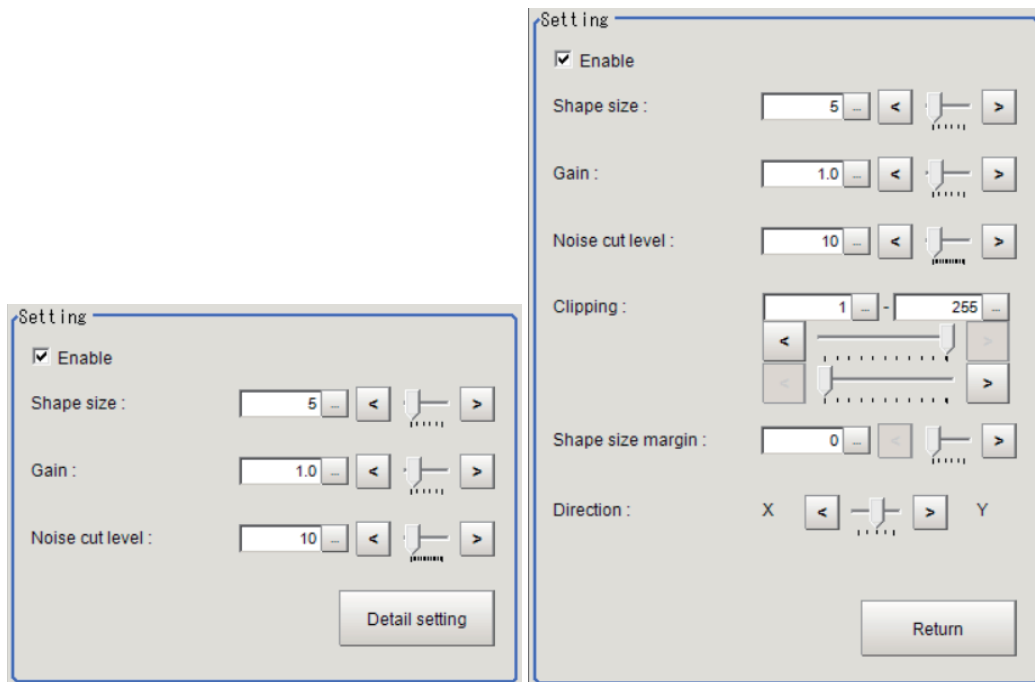

Setting item	Setting value [Factory default]	Description
Enable	<ul style="list-style-type: none"> Checked Unchecked Shape 1: [Checked] Shape 2, Shape 3: [Unchecked]	Select whether or not to create a Shape image. When selecting <i>unchecked</i> , the corresponding image will be invalid and a completely black image will be displayed.
Shape size	1 to 100 Shape 1, Shape 2: [5] Shape 3: [15]	Adjust the size of defects to extract in pixels. Increasing the value enables larger defects to be extracted.
Gain	0.1 to 10.0 Shape 1: [1.0] Shape 2: [2.6] Shape 3: [9.0]	Adjust the degree of contrast for the Shape image with magnification. Increasing the value emphasizes the concentration differences in images.
Noise cut level	0 to 255 Shape 1, Shape 2: [10] Shape 3: [30]	Adjust the Noise cut level (concentration value) for Shape images. Defects smaller than the set value will be considered as noise and not be extracted.
Clipping	1 to 255 Shape 1, Shape 2, Shape 3: [1] to [255]	Adjust the brightness (concentration value) for Shape images. Adjust the brightness saturation range with the upper limit of the clipping and the lower limit of the clipping.
Shape size margin	0 to 5 Shape 1: [0] Shape 2: [1] Shape 3: [5]	Set this when extracting multiple defects with different size. Increasing the value gives margin in the width of size for defects to extract and enables smaller size defects to be extracted. (0: No margin, 1 or higher: Split based on the maximum defect size)

Setting item	Setting value [Factory default]	Description
Direction	0 to 4 Shape 1, Shape 2, Shape 3: [2]	Adjust the emphasizing direction of the shape. Adjusting the emphasis degree (ratio) of X and Y respectively reduces patterns appeared in fixed direction like hairline. (0: Emphasize X direction, 1: Emphasize X direction a little, 2: Same in X and Y directions, 3: Emphasize Y direction a little, 4: Emphasize Y direction)



Additional Information

If defects were not detected, check the following.

- The condition of the lighting installation:
Does the center of the lighting match that of the camera?
Is the lighting not installed with an angle?
- Is the lighting start position correct?
Adjust the Position adjusting on the Screen adjust tab.
- Others:
In the *Input settings* area of the Screen adjust tab, change the input pattern from *Four* to *Eight*.
Check whether or not defects are visible on the Gradient image.
Adjust the parameters in the *Setting* area.

Texture

You can set the parameters for a Photometric Stereo image captured as a Texture image. You can analyze the change in magnitude of brightness from the Photometric Stereo image and extract a Texture image in which halation is removed from text and patterns.

- 1 In the Item tab area, click **Filter setting**.
Display of one row is added under the tab area.

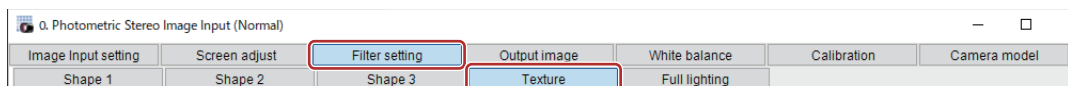

- 2 In the Item tab area, select **Texture**.
- 3 Set the parameters in the *Setting* area.

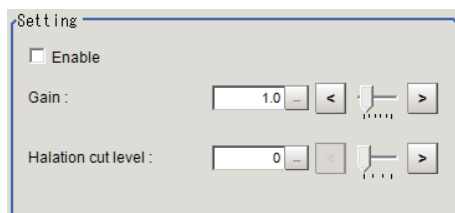

Setting item	Setting value [Factory default]	Description
Enable	<ul style="list-style-type: none"> • Checked • [Unchecked] 	Select whether or not to create a Texture image. When selecting <i>unchecked</i> , the corresponding image will be invalid and a completely black image will be displayed.

Setting item	Setting value [Factory default]	Description
Gain	0.1 to 10.0 [1.0]	Adjust the contrast for the Texture image with magnification. Increasing the value emphasizes the concentration differences in images.
Halation cut	0 to 3 [0]	Set this when halation occurs in the captured image. Increasing the value reduce the effect of halation. (0: None, 1: Weak, 2: Medium, 3: Strong)



Additional Information

If you cannot remove halation, check the following.

- The lighting installation condition: Change the distance between the lighting and the measurement object.
- Change the Light width from *Normal* to *Tight* in the Lighting control area on the Screen adjust tab.
- Other: Change the Input pattern from *Four* to *Eight* in the Input settings area of the Screen adjust tab.

Full Lighting

Image capture is performed with all lightings in the Photometric Stereo lighting fixture turned ON and illuminating. The image captured with this condition is treated as a Full lighting image.

- 1 In the Item tab area, click **Filter setting**.
Display of one row is added under the tab area.

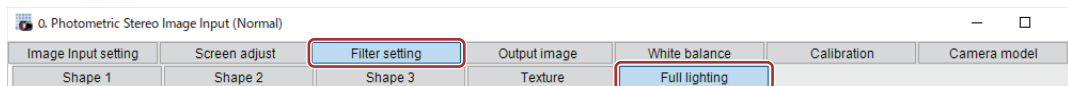

- 2 In the Item tab area, select **Full lighting**.
- 3 Adjust the parameters in the *Setting* area.



Setting item	Setting value [Factory default]	Description
Enable	<ul style="list-style-type: none"> • [Checked] • Unchecked 	Select whether or not to capture images with Full lighting. When selecting <i>unchecked</i> , the corresponding image will be invalid and a completely black image will be displayed.

1-7-5 Output Image (Photometric Stereo Image Input (using FH Controller))

Set the image to be output to the subsequent stage in the processing flow from among the images created by this filter.

Output Image Setting

Set the image to output from among the images created by this filter setting.

If you set an image that has not been created with this, a completely dark image will be output.

- 1 In the Item tab area, click **Output image**.
- 2 Select the Output image in the *Output image setting* area.

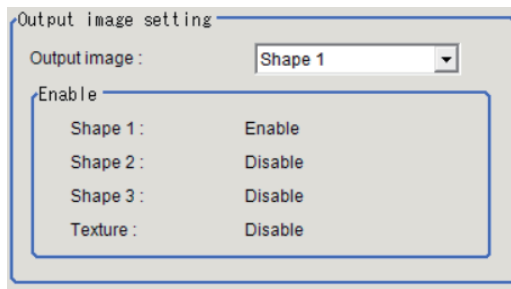

Setting item	Setting value [Factory default]	Description
Output image	<ul style="list-style-type: none"> • [Shape 1] • Shape 2 • Shape 3 • Texture 	Set the Output image. If you select an image not created as an Output image, it will be invalid and a completely dark image will be output.

1-7-6 White Balance (Photometric Stereo Image Input (using FH Controller))

- Refer to 1-2-6 *White Balance (Camera Image Input FH)* on page 1-56

1-7-7 Calibration (Photometric Stereo Image Input (using FH Controller))

- Refer to 1-2-7 *Calibration (Camera Image Input FH)* on page 1-58

1-7-8 Camera Model (Photometric Stereo Image Input (using FH Controller))

You can check the camera model currently connected.

Camera Model

Set the image to output from among the images created by this filter setting.

If you set an image that has not been created with this, a completely dark image will be output.

- 1 In the Item tab area, click **Camera model**.



- 2** In the *Camera model* area, you can verify the camera model for the Camera No. currently selected on the *Input image setting* tab.

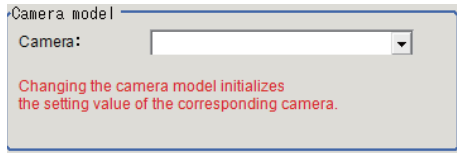

Additional Information

When using the simulation software, you can select any camera model in the *Camera model* area. Changing the camera model will initialize the correspondence camera settings.

1-7-9 External Reference Tables (Photometric Stereo Image Input (using FH Controller))

No.	Data name	Data ident	Set/Get	Data range
10,000	Judge	judge	Get only	0: No judgment (unmeasured), 1: Judgment result OK, -1: Judgment result NG, -10: Error (image format mismatch), -11: Error (unregistered model), -12: Error (insufficient memory), -20: Error (other errors)

1-8 Photometric Stereo Image Input (using FHV Controller)

This processing item requires the specialized Photometric Stereo lighting controller (FL-TCC1PS) or the internal lighting (FHV-LTM-R/FHV-LTM-W/FHV-LTM-IR) to work properly.

Using the Photometric Stereo lighting, set the conditions for loading images from the camera and storing images of measured objects.

Images irradiated from different directions with the Photometric Stereo lighting are filtered and extracted shape images (to reveal surface unevenness defects such as dents) and texture images (for better character and pattern recognition).

When the FH Controller is used, refer to *1-7 Photometric Stereo Image Input (using FH Controller)* on page 1-122.



Precautions for Correct Use

- When setting this processing item with logged images, logged images are required in a state that the multiple times captured image logging is set to **Yes** in the image logging. For details, refer to *Logging Measurement Values and Measurement Images [Data Logging / Image Logging]* in the *Vision System FH/FHV Series User's Manual (Cat. No. Z365)*.
 - When using this processing item, install cameras and lightings to observe the following issues.
 - The cameras and lightings should be installed in nearly parallel with the imaging target.
 - Lightings should be installed so that the imaging target is located in the center of a ring type lighting.
 - For this processing item, do not use scene variables or system-defined variables as parameters.
-

Used in the Following Case

When detecting defects using multiple images irradiated from different directions using lighting:

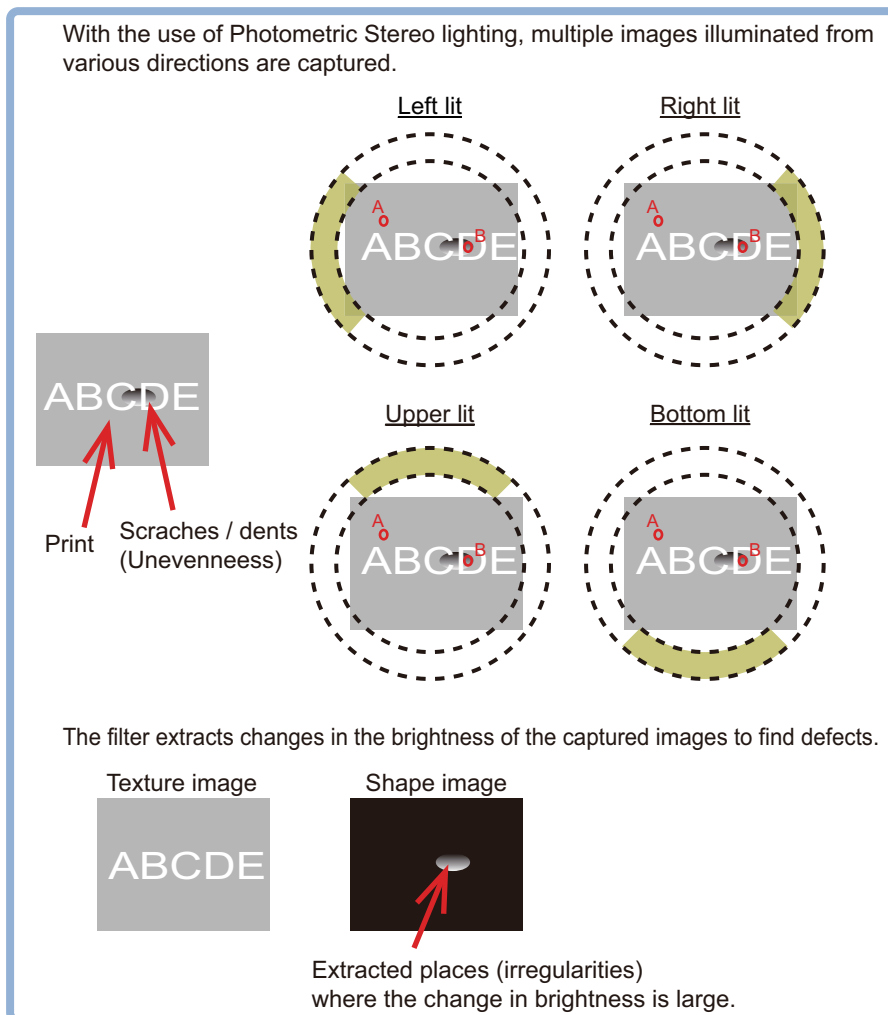

Precautions for Correct Use

- *Camera Image Input FHV* is preset for Unit 0. Set only a Camera Image Input processing item related to FHV to Unit 0.
- When switching from a color camera to a monochrome camera or switching to a camera with a different resolution, reset the following units.
- If a camera model is different from the previous one, the camera settings are returned to the initial ones. As same as the camera settings, a lighting and/or lens model is different from the previous one, the settings are also returned to the initial ones.
- Just after starting up the Sensor Controller or just after changing scenes, it becomes no image input. In this state, it is set to the same color image processing as in the factory default state.
- When the *Properties* dialog box is opened with no image input, click the **Cancel** button to close the dialog box. Pressing the **OK** button in the dialog box will change the setting to the same color camera setting as the factory default state.

For details, *FAQ - For Measurement - The measurement NG (image mismatch) error will result when connecting a monochrome camera in the Vision System FH/FHV Series User's Manual* (Cat. No. Z365).

1-8-1 Settings Flow (Photometric Stereo Image Input (using FHV Controller))

To set Photometric Stereo Image Input (using FHV Controller), follow the steps below.

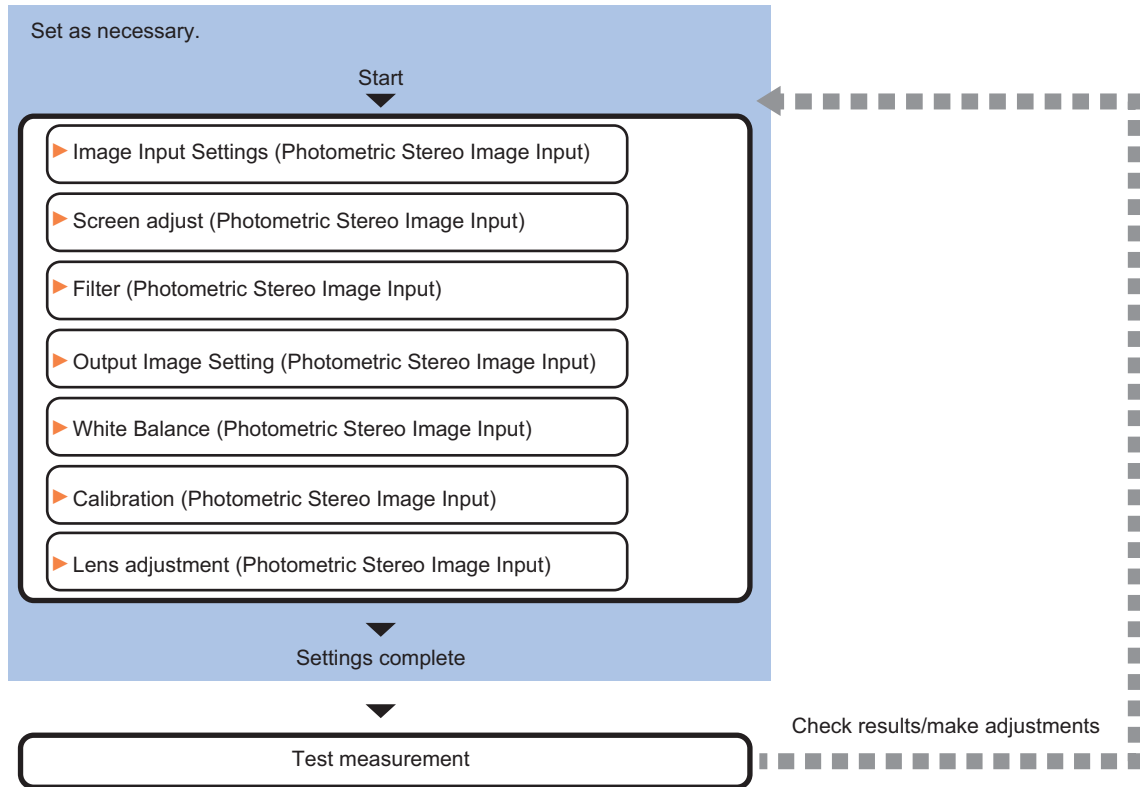

List of Photometric Stereo Image Input Items

Item	Description
Image input settings	Set related to cameras and lightings. <i>1-8-2 Image Input Settings (Photometric Stereo Image Input (using FHV Controller))</i> on page 1-147
Screen adjust	Specify the Photometric Stereo Lighting settings. <i>1-8-3 Screen Adjust (Photometric Stereo Image Input (using FHV Controller))</i> on page 1-155
Filter	Specify the Photometric Stereo image filter parameters. <i>1-8-4 Filter (Photometric Stereo Image Input (using FHV Controller))</i> on page 1-160
Output image setting	Set the image to be output to the subsequent stage in the processing flow from among the images created by this filter. The setting method is the same as Photometric Stereo Image Input (FH Controller). Refer to it. <i>1-8-5 Output Image (Photometric Stereo Image Input (using FHV Controller))</i> on page 1-164
White balance	When using a color camera, adjust the white balance. The setting method is the same as Camera Image Input FHV. Refer to it. <i>1-8-6 White Balance (Photometric Stereo Image Input (using FHV Controller))</i> on page 1-164
Calibration	Set when measurements (camera coordinate measurement values) are to be output using actual dimensions. Select the calibration setting method and generate the calibration parameters. The setting method is the same as Camera Image Input FHV. Refer to it. <i>1-8-7 Calibration (Photometric Stereo Image Input (using FHV Controller))</i> on page 1-164
Lens adjustment	Adjust the focus for a lens. <i>1-8-8 Lens Adjustment (Photometric Stereo Image Input (using FHV Controller))</i> on page 1-164.
Camera model	Check the type of camera, lighting, and lens that are currently connected. <i>1-8-9 Camera Model (Photometric Stereo Image Input (using FHV Controller))</i> on page 1-166

1-8-2 Image Input Settings (Photometric Stereo Image Input (using FHV Controller))

Set the following photographing conditions



Additional Information

The display items differ depending on the camera model and lighting mode. Perform the setting with the following procedures according to the usage environment.

Display

Switches the display in the Image area.

- 1 In the Item tab area, click one of the tabs.
Any item tab can set this.

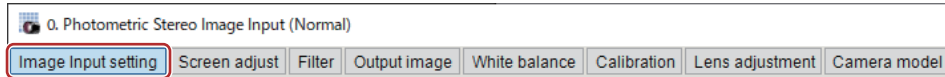

- 2 Click **Change display** to select the type of camera image. The display in the *Image display* area will switch.



Setting item	Setting value [Factory default]	Description
Display	<ul style="list-style-type: none"> • Through image • [Freeze image] 	<ul style="list-style-type: none"> • Through image: The latest image is always loaded from the camera and displayed. • Freeze image: The image loaded in the immediately preceding measurement is displayed.

Camera Settings

Adjust the settings related to camera shutter speed and camera gain.

Set the shutter speed appropriate to the speed of the measurement object. Choose a faster shutter speed if the measurement object is moving quickly and the image is blurred.

Adjust the camera gain when images cannot be brightened through the shutter speed, lens aperture, or lighting conditions. Usually, the factory default values can be used.

Example:

Camera gain	Image quality	Image
240	Very poor (too much noise)	bright
0	Very good (less noise)	dark

- 1 In the Item tab area, click **Image input setting**.

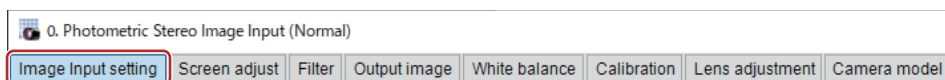

- 2 In the *Camera settings* area, specify the shutter speed.

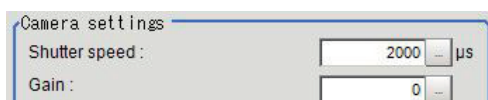

Setting item	Setting value [Factory default]	Description
Shutter speed	FHV7□-M004□/FHV7□-M008□/ FHV7□-M016□/FHV7□-M032□/ FHV7□-M050□/FHV7□-C004□/ FHV7□-C008□/FHV7□-C016□/ FHV7□-C032□/FHV7□-C050□ 1 to 100,000 [μs] [2,000] FHV7□-M063R□/FHV7□-C063R□ 55 to 100,000 [μs] [2,000] *1 FHV7□-M120R□/FHV7□-C120R□ 84 to 100,000 [μs] [2,000] *1	The <i>Shutter speed</i> option varies depending on the camera model.

- *1. Note that the shutter speed for FHV7□-M063R□/FHV7□-M120R□/FHV7□-C063R□/FHV7□-C120R□ is below.
Settable value on the screen: 1 [μs] step
Actual shutter speed: 7.79 [μs] step
The setting value on the screen is converted in the camera to a close value to it and reflected in the actual operation.

3 Specify the camera gain while checking the image.



Setting item	Setting value [Factory default]	Description
Gain	FHV7□-M004□/FHV7□-M008□/ FHV7□-M016□/FHV7□-M032□/ FHV7□-M050□/FHV7□-C004□/ FHV7□-C008□/FHV7□-C016□/ FHV7□-C032□/FHV7□-C050□ 0 to 240 [0] FHV7□-M063R□/FHV7□-M120R□/ FHV7□-C063R□/FHV7□-C120R□ 0 to 180 [0]	Adjust the <i>camera gain</i> when the shutter speed, the lens aperture, and lighting conditions cannot be used to brighten the image. Usually, the factory default value can be used.



Precautions for Correct Use

- Due to the specification of its imaging elements, a CMOS camera generates stripe noises when the gain setting of the camera is raised. You may also find multiple defective pixels, but they do not represent a defect or failure of the product in any way. If stripe noises and defective pixels affect the measurement results, lower the gain setting of the camera.
- When performing defect inspection, keep the gain setting at a low value to suppress the influence of image noise.

Reset Mode (for FHV7□-M063R□/FHV7□-C063R□/FHV7□-M120R□/FHV7□-C120R□ only)

In Photometric Stereo Image Input, the Reset mode for a Rolling shutter camera is Rolling shutter.

- Reset mode:

Rolling Shutter: Use this mode when capturing static objects.

Global Reset: Use this mode when capturing moving objects.

For details, refer to *Reset Mode (for FHV7□-M063R□/FHV7□-C063R□/FHV7□-M120R□/FHV7□-C120R□ only)* on page 1-70.

Number of Lines to be Read

By narrowing the image range to be loaded, the image scan time can be shortened.

Set the range taking the offset of the measurement object into consideration.

The part of the image narrowed down by the start line and the end line will be displayed in the setting screen of the processing item window and the Image Display area of the Main screen.

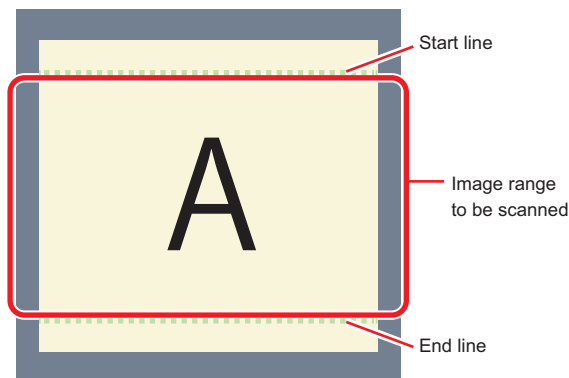

Additional Information

About the minimum number of lines:

- For FHV7□-M004□/FHV7□-M008□/FHV7□-M016□/FHV7□-M032□/FHV7□-M050□/ FHV7□-C004□/ FHV7□-C008□/ FHV7□-C016□/ FHV7□-C032□/ FHV7□-C050□, the minimum number of lines (minimum value between the start and end lines) is 3 lines.
- For FHV7□-M063R□/FHV7□-M120R□/FHV7□-C063R□/FHV7□-C120R□, the minimum number of lines is 3 lines.
- The step width from the start to end lines is 4 lines.

About coordinate values:

- The coordinate values of the measurement results are the display position values on the monitor.
- The coordinate values will not vary with this setting.

- 1 In the Item tab area, click **Image input setting**.

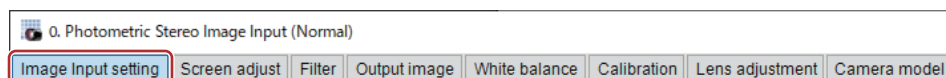

- 2 Set the start and end lines in the *Number of Lines to be Read* area.

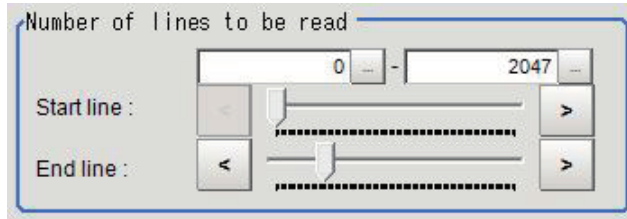

Precautions for Correct Use

When FHV7□-M063R□/FHV7□-M120R□/FHV7□-C063R□/FHV7□-C120R□ is used, the processing time may not be shortened.

Electronic Flash Setting

This function is set when an electronic flash is used. This sets the output conditions for the signal to synchronize the measurement and the electronic flash timing.



Precautions for Correct Use

The setting here applies when *STGOUT* is selected for the output signal in *Common settings* on the *Output signal settings* page of the camera accessed by selecting **Tool - System settings**. When *STGOUT* is selected, the signal is controlled by each setting value of *SHTOUT* for each line.

For details, refer to *Setting the SHTOUT Signal [Output Signal Settings]* in the *Vision System FH/FHV Series User's manual (Cat. No. Z365)*.

- 1 In the Item tab area, click **Image input setting**.

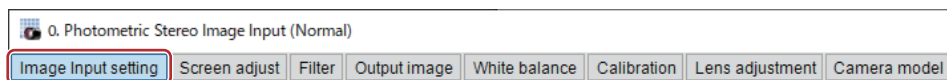

- 2 In the *Electronic flash setting* area, specify each item.

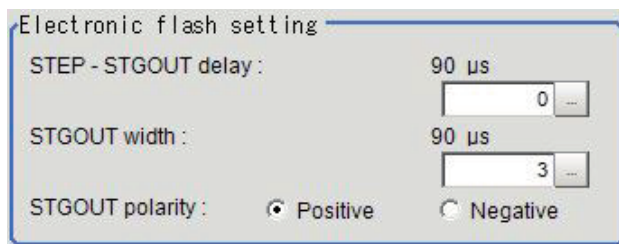

Setting item	Setting value [Factory default]	Description
STEP-STGOUT delay	0 to 511 [0] (1 count: 30 [μs])	Sets the waiting time from the time the start of this camera image input processing item until the electronic flash trigger output signal comes ON. Delay time = Count × 30 μs + 90 μs The delay time varies depending on the <i>polarity of STGOUT pulse</i> . The displayed time is for the positive polarity. Add 35 [μs] to the displayed time when the polarity is negative. The display time becomes within a range of ±10 [μs] to the setting value.
STGOUT width	0 to 43,689 [3] (1 count: 30 [μs])	Sets the output time for the electronic flash trigger signal. If 0 is set, the electronic flash will not flash.
STGOUT polarity	<ul style="list-style-type: none"> [Positive] Negative 	Selects the pulse polarity of the electronic flash trigger. <ul style="list-style-type: none"> Positive polarity Flashes synchronized with the timing of the electronic flash trigger output signal changing from OFF to ON. Negative polarity Flashes synchronized with the timing of the electronic flash trigger output signal changing from ON to OFF.



Precautions for Correct Use

- Do not perform next camera image input processing before STGOUT signal output is completed. If it were done, STGOUT signal may not be output. Perform camera image input processing after STGOUT signal output is completed or set the STEP-camera delay, STEP-STGOUT delay, and STGOUT pulse width properly so that the electronic flash flashes synchronizing with the exposure time.

Input Time

You can verify the Input time. The time required for image input and filter processing is displayed.

- In the Item tab area, click **Image input setting**.

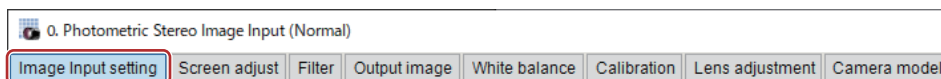

- The Input time is displayed.



Display Setting

You can change how it is displayed.

- In the Item tab area, click **Image input setting**.

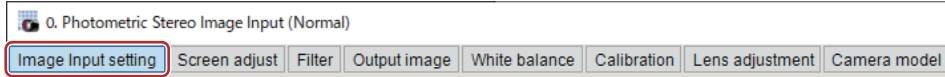

- 2** Select the image to display in the *Display setting* area.
The applicable settings are reflected in the *Image display* area of the processing item.

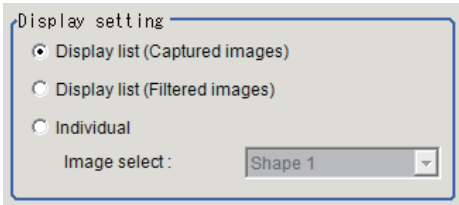

Setting item	Setting value [Factory default]	Description
Display settings	<ul style="list-style-type: none"> • [Display lists (Captured images)] • Display list (Filtered images)] • Individual 	The applicable settings are displayed in the <i>Image display</i> area of the processing item. *1
Select image	<ul style="list-style-type: none"> • [Shape 1] • Shape 2 • Shape 3 • Texture • Full lighting • Captured image 1 • Captured image 2 • Captured image 3 • Captured image 4 • Captured image 5 • Captured image 6 • Captured image 7 • Captured image 8 	Select an image to display when Individual is set for the Display setting.

- *1. **Display list (Captured images):**
The captured image and full lighting image is displayed

Selected Input pattern is Four

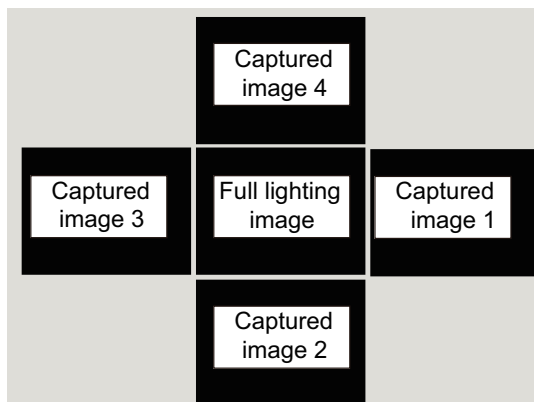

Displayed list (Filtered images):

Selected Input pattern is Eight

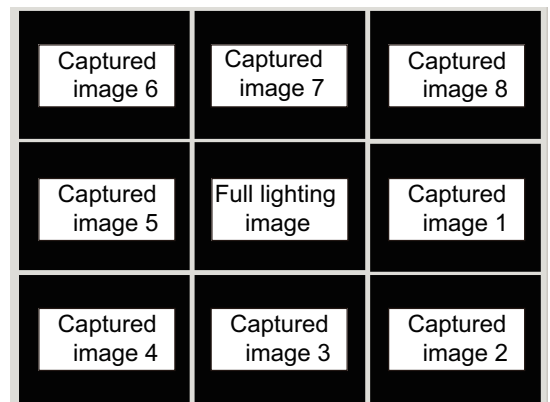

Individual

Displays the Shape images and Texture images.

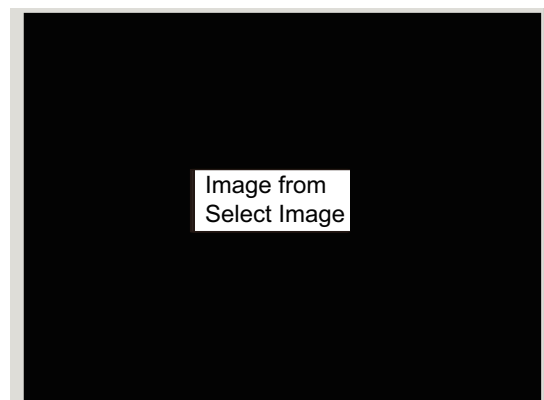
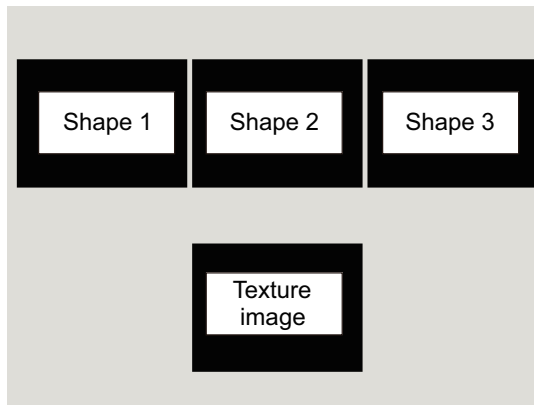

1-8-3 Screen Adjust (Photometric Stereo Image Input (using FHV Controller))

Set the conditions for the Photometric Stereo lighting.

Input Settings

You can select the Input pattern for the connected Photometric Stereo lighting.

The setting is valid only when the **Select light** is *External light*.

If the **Select light** is *Internal light*, the **Input pattern** cannot be changed from *Four* shots.

- 1 In the Item tab area, click **Screen adjust**.

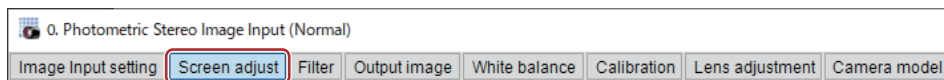

- 2 In the *Input settings* area, select the Input pattern to use.

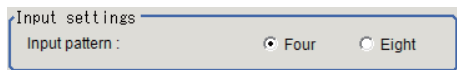

Setting item	Setting value [Factory default]	Description
Input pattern	<ul style="list-style-type: none"> • [Four] • Eight 	Select the <i>Input pattern</i> for Photometric Stereo lighting to use for image capture. <ul style="list-style-type: none"> • Four: Illuminate from 4 directions and capture 4 images. • Eight: Illuminate from 8 directions and capture 8 images.

The applicable settings are reflected in the *Image display* area of the processing item.

Input pattern: Four

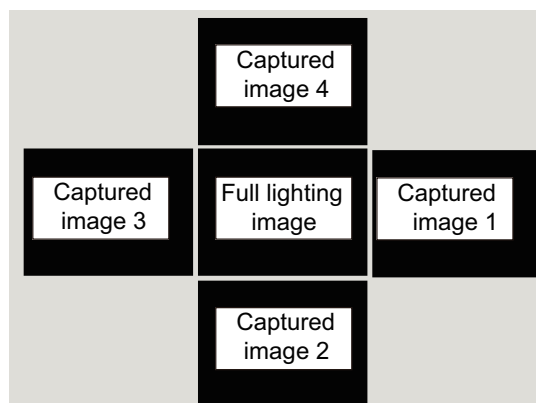

Input pattern: Eight

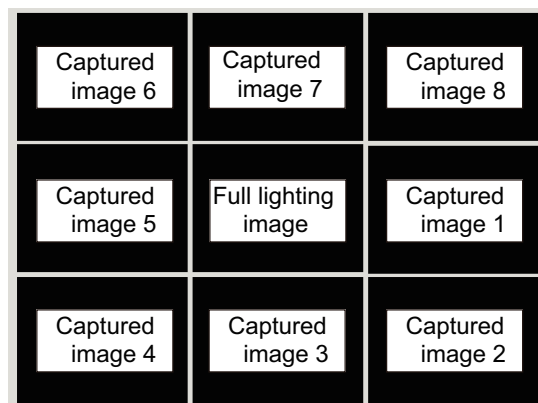

Lighting Control Settings

You can adjust the connected Photometric Stereo lighting settings from the FH Controller. You can adjust not only the illuminating width and intensity of the lighting but also the illuminating direction.

- 1 In the Item tab area, click **Screen adjust**.

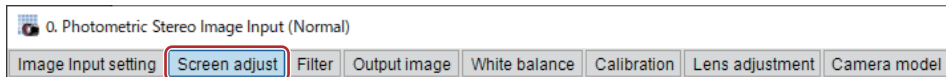

- 2 In the *Lighting control* area, adjust the settings for the Photometric Stereo lighting.
 - When the **Select light** is *External light*:

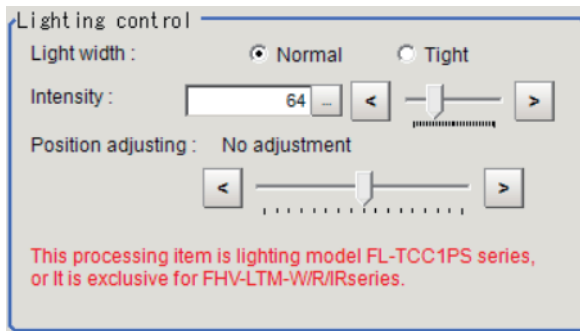

- When the **Select light** is *Internal light*:

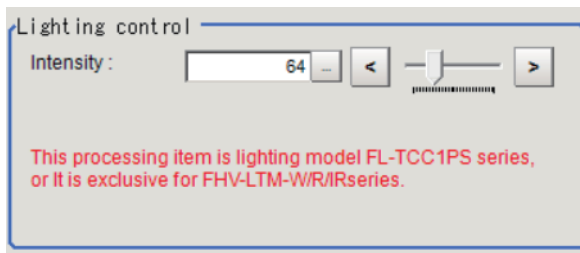

When the **Select light** is *Internal light*, **Light width** and **Position adjustment** cannot be set.

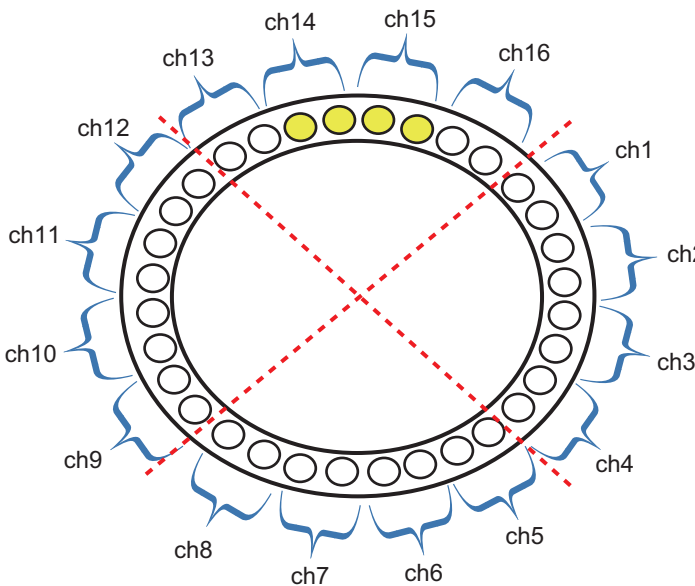
Setting item	Setting value [Factory default]	Description
Light width	<ul style="list-style-type: none"> • [Normal] • Tight 	<p>Select the width of the area to illuminate.</p> <ul style="list-style-type: none"> • Normal: For image capture in one direction, four channels emit light. When the <i>Input pattern</i> is <i>Four</i>, the light emitting position moves clockwise by 4ch at a time. When the <i>Input pattern</i> is <i>Eight</i>, the light emitting position moves clockwise by 2ch at a time. • Tight: Four image capture in one direction, 2 channels emit light. Use this setting when there is a high degree of halation. When the <i>Input pattern</i> is <i>Four</i>, the light emitting position moves clockwise by 4ch at a time. When the <i>Input pattern</i> is <i>Eight</i>, the light emitting position moves clockwise by 2ch at a time. 
Intensity	0 to 255 [64]	Set the intensity of the lighting.

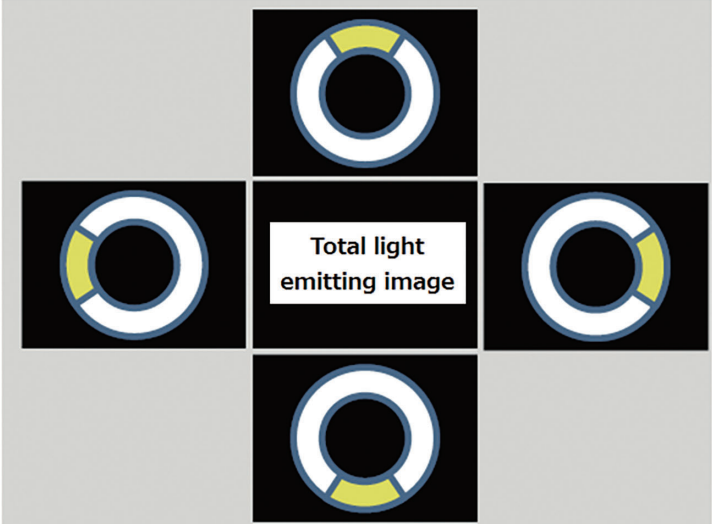
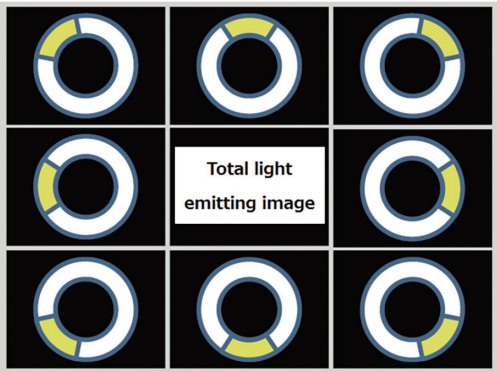
Setting item	Setting value [Factory default]	Description
Position adjustment	<ul style="list-style-type: none"> • CCW 180° • CCW 157.5° • CCW 135° • CCW 112.5° • CCW 90° • CCW 67.5° • CCW 45° • CCW 22.5° • [No adjustment] • CW 22.5° • CW 45° • CW 67.5° • CW 90° • CW 112.5° • CW 135° • CW 157.5° • CW 180° 	<p>You can shift the illuminating position of the lighting. Shown below figure, adjust so that the display position of the screen and the lighting position of the lighting match. <i>Input pattern: Four - Lighting illuminating position</i></p>  <p><i>Input pattern: Eight - Lighting illuminating position</i></p> 

Select Light

- 1 In the *Lighting selection* area, select a model of lighting to be used.

Setting item	Setting value [Factory default]	Description
Select	<ul style="list-style-type: none"> • Internal lighting • External lighting 	Select a lighting used in the unit.*1

*1. Internal lighting and external lighting cannot be used at the same time.

Line Bright

The graph showing the gray distribution for one line in the image is called the *Line Bright*. you can play the line brights for R, G, and B for any horizontal or vertical line.

- 1 In the Item tab area, click **Screen adjust**.

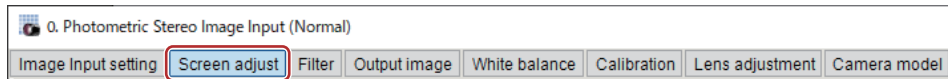

- 2 In the *Display setting* area, select *Individual*.

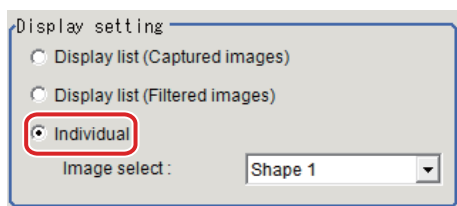

- 3 In the *Line bright* area, place a check in the check box for *Display line bright*.

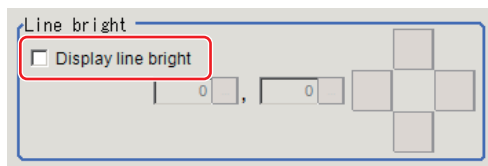

- 4 Move the line to the position whose density distribution you want to see.

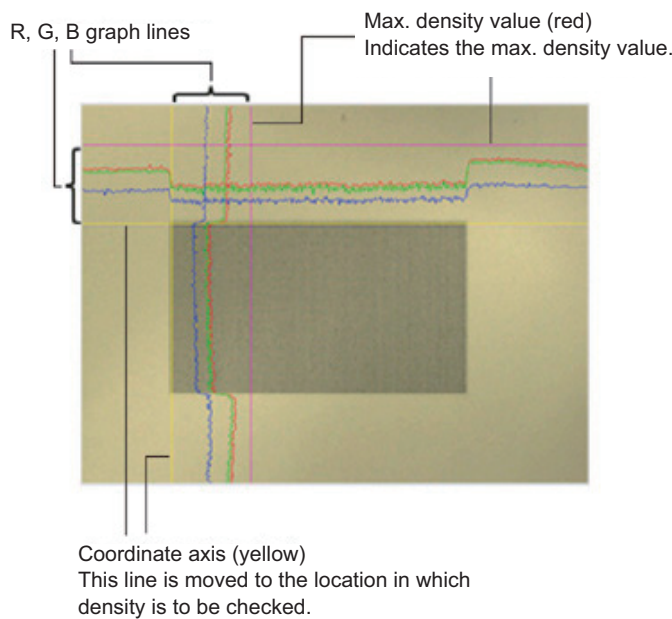

1-8-4 Filter (Photometric Stereo Image Input (using FHV Controller))

Adjust the Photometric Stereo image filter parameters.

Shape 1, Shape 2, Shape 3

You can set the filter parameters for a Photometric Stereo image captured as a Shape image. You can analyze the change in magnitude of brightness from the captured Photometric Stereo image and can extract defects as Shape images.

- 1 In the Item tab area, click **Filter**.
Display of one row is added under the tab area.

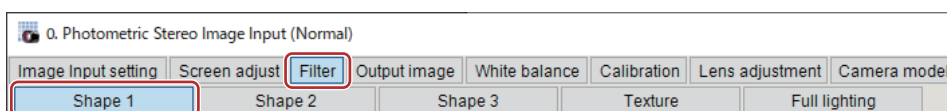

- 2 In the Item tab area, select **Shape 1**, **Shape 2**, or **Shape 3**.
- 3 In the *Display setting* area, you can toggle the display between Shape image and Display gradient image.
In the Gradient image, you can check whether the defect you want to detect (emphasis) is visible for the captured image.
The image is the result of calculating the degree of brightness change on the X slope in the horizontal direction and the Y slope in the vertical direction.
The Gradient image is not linked with the parameters used in the Setting area.

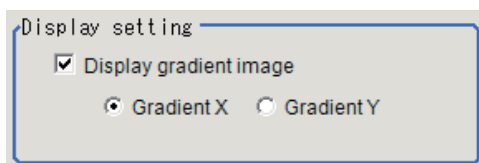

Setting item	Setting value [Factory default]	Description
Display gradient image	<ul style="list-style-type: none"> • Checked • [Unchecked] 	<ul style="list-style-type: none"> • Checked: A gradient image is displayed. • Unchecked: A Shape image is displayed.
Gradient image type	<ul style="list-style-type: none"> • [Gradient X] • Gradient Y 	Set this when displaying a Gradient image. <ul style="list-style-type: none"> • Gradient X: Image obtained as a result of calculating the degree of change in brightness in the horizontal direction. • Gradient Y: Image obtained as a result of calculating the degree of change in brightness in the vertical direction. When unchecking <i>Display gradient image</i> , this function is disabled.

- 4 In the *Settings* area, adjust the parameters for a Shape image.

Click **Detail setting** to set more parameters as necessary.

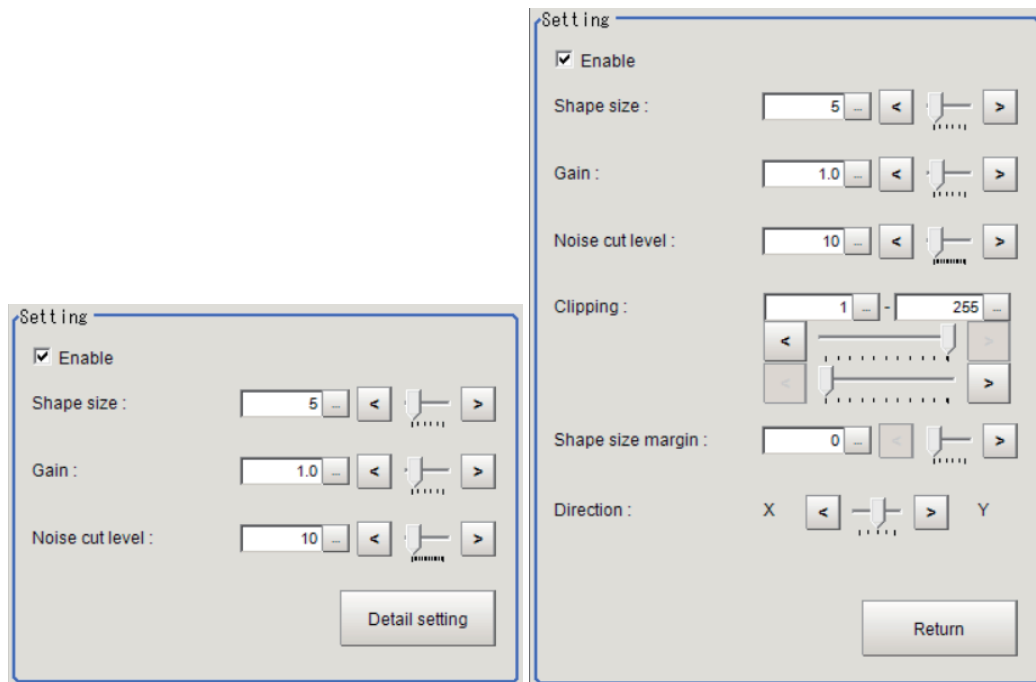

Setting item	Setting value [Factory default]	Description
Enable	<ul style="list-style-type: none"> Checked Unchecked Shape 1: [Checked] Shape 2, Shape 3: [Unchecked]	Select whether or not to create a Shape image. When selecting <i>unchecked</i> , the corresponding image will be invalid and a completely black image will be displayed.
Shape size	1 to 100 Shape 1, Shape 2: [5] Shape 3: [15]	Adjust the size of defects to extract in pixels. Increasing the value enables larger defects to be extracted.
Gain	0.1 to 10.0 Shape 1: [1.0] Shape 2: [2.6] Shape 3: [9.0]	Adjust the degree of contrast for the Shape image with magnification. Increasing the value emphasizes the concentration differences in images.
Noise cut level	0 to 255 Shape 1, Shape 2: [10] Shape 3: [30]	Adjust the Noise cut level (concentration value) for Shape images. Defects smaller than the set value will be considered as noise and not be extracted.
Clipping	1 to 255 Shape 1, Shape 2, Shape 3: [1] to [255]	Adjust the brightness (concentration value) for Shape images. Adjust the brightness saturation range with the upper limit of the clipping and the lower limit of the clipping.
Shape size margin	0 to 5 Shape 1: [0] Shape 2: [1] Shape 3: [5]	Set this when extracting multiple defects with different size. Increasing the value gives margin in the width of size for defects to extract and enables smaller size defects to be extracted. (0: No margin, 1 or higher: Split based on the maximum defect size)

Setting item	Setting value [Factory default]	Description
Direction	0 to 4 Shape 1, Shape 2, Shape 3: [2]	Adjust the emphasizing direction of the shape. Adjusting the emphasis degree (ratio) of X and Y respectively reduces patterns appeared in fixed direction like hairline. (0: Emphasize X direction, 1: Emphasize X direction a little, 2: Same in X and Y directions, 3: Emphasize Y direction a little, 4: Emphasize Y direction)



Additional Information

If defects were not detected, check the following.

- The condition of the lighting installation:
Does the center of the lighting match that of the camera?
Is the lighting not installed with an angle?
- Is the lighting start position correct?
Adjust the Position adjusting on the Screen adjust tab.
- Others:
In the *Input settings* area of the Screen adjust tab, change the input pattern from *Four* to *Eight*.
Check whether or not defects are visible on the Gradient image.
Adjust the parameters in the *Setting* area.

Texture

You can set the parameters for a Photometric Stereo image captured as a Texture image. You can analyze the change in magnitude of brightness from the Photometric Stereo image and extract a Texture image in which halation is removed from text and patterns.

- 1 In the Item tab area, click **Filter**.
Display of one row is added under the tab area.

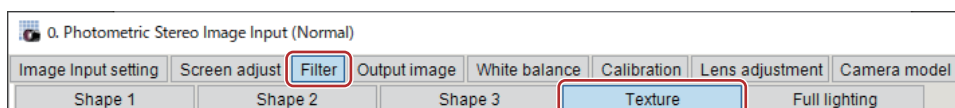

- 2 In the Item tab area, select **Texture**.
- 3 Set the parameters in the *Setting* area.

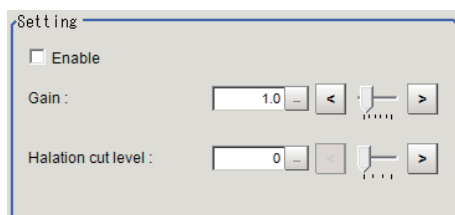

Setting item	Setting value [Factory default]	Description
Enable	<ul style="list-style-type: none"> Checked [Unchecked] 	Select whether or not to create a Texture image. When selecting <i>unchecked</i> , the corresponding image will be invalid and a completely black image will be displayed.
Gain	0.1 to 10.0 [1.0]	Adjust the contrast for the Texture image with magnification. Increasing the value emphasizes the concentration differences in images.
Halation cut	0 to 3 [0]	Set this when halation occurs in the captured image. Increasing the value reduce the effect of halation. (0: None, 1: Weak, 2: Medium, 3: Strong)



Additional Information

If you cannot remove halation, check the following.

- The lighting installation condition: Change the distance between the lighting and the measurement object.
- Change the Light width from *Normal* to *Tight* in the Lighting control area on the Screen adjust tab.
- Other: Change the Input pattern from *Four* to *Eight* in the Input settings area of the Screen adjust tab.

Full Lighting

Image capture is performed with all lightings in the Photometric Stereo lighting fixture turned ON and illuminating. The image captured with this condition is treated as a Full lighting image.

- 1 In the Item tab area, click **Filter**.
Display of one row is added under the tab area.

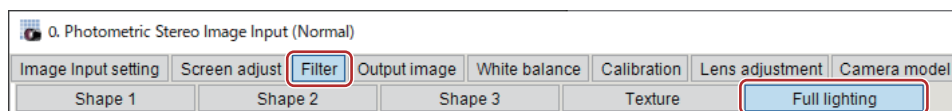

- 2 In the Item tab area, select **Full lighting**.
- 3 Adjust the parameters in the *Setting* area.

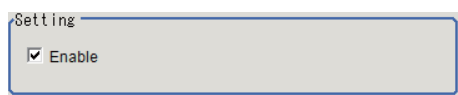

Setting item	Setting value [Factory default]	Description
Enable	<ul style="list-style-type: none"> [Checked] Unchecked 	Select whether or not to capture images with Full lighting. When selecting <i>unchecked</i> , the corresponding image will be invalid and a completely black image will be displayed.

1-8-5 Output Image (Photometric Stereo Image Input (using FHV Controller))

Set the image to be output to the subsequent stage in the processing flow from among the images created by this filter.

Output Image Setting

Set the image to output from among the images created by this filter setting.

If you set an image that has not been created with this, a completely dark image will be output.

- 1 In the Item tab area, click **Output image**.
- 2 Select the Output image in the *Output image setting* area.

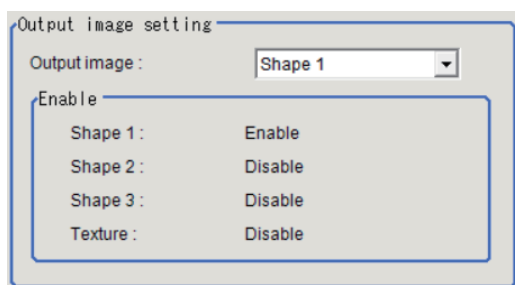

Setting item	Setting value [Factory default]	Description
Output image	<ul style="list-style-type: none"> • [Shape 1] • Shape 2 • Shape 3 • Texture 	Set the Output image. If you select an image not created as an Output image, it will be invalid and a completely dark image will be output.

1-8-6 White Balance (Photometric Stereo Image Input (using FHV Controller))

- 1-3-5 White Balance (Camera Image Input FHV) on page 1-82

1-8-7 Calibration (Photometric Stereo Image Input (using FHV Controller))

- 1-3-6 Calibration (Camera Image Input FHV) on page 1-83

1-8-8 Lens Adjustment (Photometric Stereo Image Input (using FHV Controller))

Sets the focus for lens module.

- 1 In the Item tab area, click **Lens adjustment**.

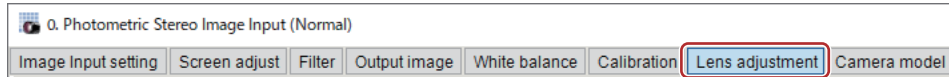

- 2** In the *Common setting for all cameras* area, set the *Camera adjust* area.

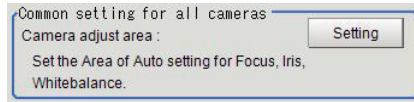

- 3** In the *Lens adjustment* area, specify a value for the *Focus*.

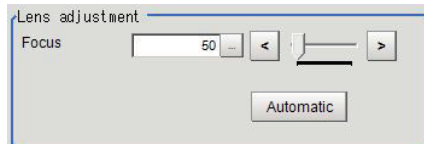

Setting item	Setting value [Factory default]	Description
Focus	FHV-LEM-S06: 26 to 260 [50] FHV-LEM-S09: 18 to 480 [50] FHV-LEM-S12: 47 to 815 [50] FHV-LEM-S16: 10 to 685 [50] FHV-LEM-S25: 37 to 885 [50] FHV-LEM-H06/FHV-LEM-H19 : 0 to 1,023 [50]	Sets the focus value.
Automatic	-	This is used to set the focus value automatically. (Autofocus) ^{*1} Sets the <i>Focus</i> automatically to the <i>Camera adjust area</i> in the <i>Common setting for all cameras</i> .

*1. The time for automatic focus adjustment varies depending on the initial value, range, and adjustment area, also camera settings and lighting settings.

1-8-9 Camera Model (Photometric Stereo Image Input (using FHV Controller))

Check the type of camera, lighting, and lens that are currently connected.

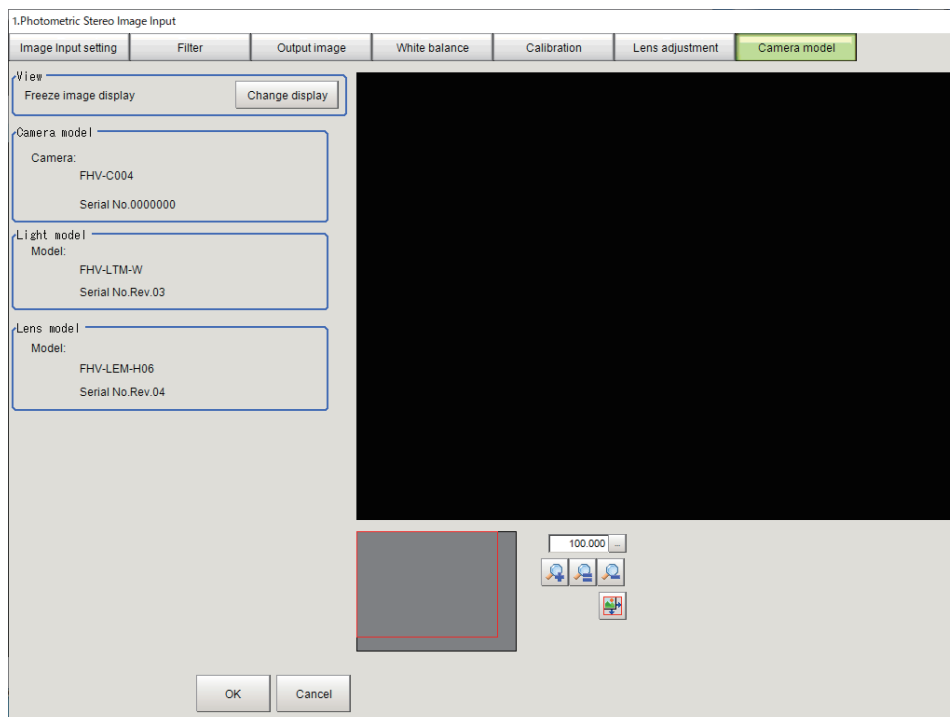

- 1 In the Item tab area, click **Camera model**.
- 2 In the *Camera model* area, you can check the camera model that is currently connected.
- 3 In the *Light model* area, you can check the lighting model that is currently connected.
- 4 In the *Lens model* area, you can check the lens model that is currently connected.



Additional Information

When using the simulation software, you can select any model in the *Camera model*, *Light model*, and *Lens model* areas. When the model is changed, the corresponding settings are initialized.

1-8-10 External Reference Tables (Photometric Stereo Image Input (using FHV Controller))

No.	Data name	Data ident	Set/Get	Data range
10,000	Judge	judge	Get only	0: No judgment (unmeasured), 1: Judgment result OK, -1: Judgment result NG, -10: Error (image format mismatch), -11: Error (unregistered model), -12: Error (insufficient memory), -20: Error (other errors)

1-9 Camera Switching

This processing item can not be used in the FHV series.

Used in the Following Case

During scene processing, in the case of switching to images captured with a camera other than the camera set in Camera Image Input.

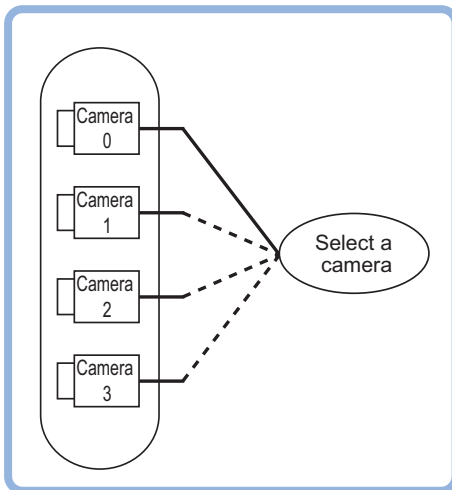

Precautions for Correct Use

- When switching from a monochrome camera to color camera, reconfigure the settings in the following units.
- Camera switching is unavailable in *Camera Image Input HDR*.

1-9-1 Camera Selection (Camera Switching)

- 1 Select a camera used for measurement.

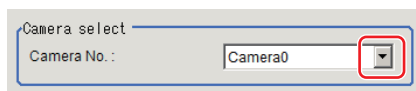

- 2 Click **OK**.
The settings are completed.

1-9-2 Additional Explanation (Camera Switching)

When *Camera Switching* is set after *Position Compensation* in a scene, *Position Compensation* is disabled and the image of a measured object is restored to the one before the compensation is applied.

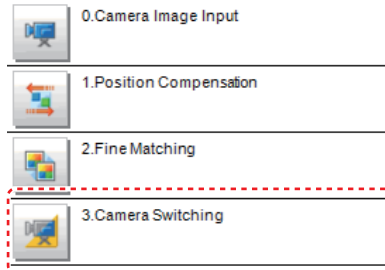

The Position Compensation for Unit 1 is being cancelled, making it restore to its former state before the Position Compensation was applied.

1-9-3 External Reference Tables (Camera Switching)

No.	Data name	Data ident	Set/Get	Data range
None	Judge	judge	Get only	0: No judgment (unmeasured), 1: Judgment result OK, -1: Judgment result NG, -10: Error (image format mismatch), -11: Error (unregistered model), -12: Error (insufficient memory), -20: Error (other errors)
None	Camera No.	cameraNo	Set/Get	

1-10 Measurement Image Switching

This processing item sets the output images for the camera image input processing items or specified image conversion related processing items as the input images for the processing items set in the flow from this processing item onward.

This is primarily used to return converted images back to their originals or to increase the selectable images as conversion targets for image conversion related processing items by placing before the image conversion related processing items.

Used in the Following Case

In the case of returning a converted image to its original:

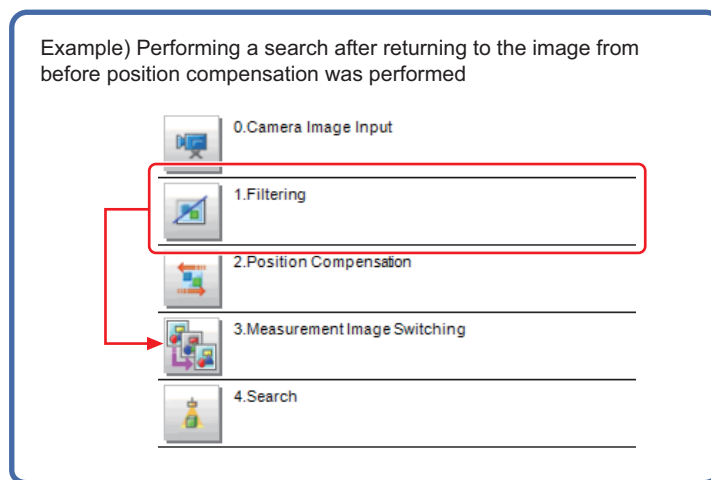

1-10-1 Parameter Settings (Measurement Image Switching)

Select the processing unit outputting images to be set.

Select a processing unit placed in the former position from this processing item in the flow.

- 1 Specify the target unit in *Target* area.

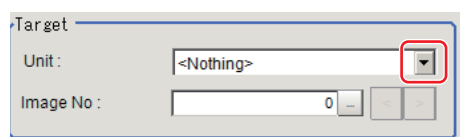

Setting item	Setting value [Factory default]	Description
Unit	0. processing unit to 9,999. processing unit [< Nothing>]	Output images as the target for reconfiguration. Select one whose flow order is before this processing item.
Image No.	0 to 9,999 [0]	No. of the image held by the target unit.



Precautions for Correct Use

- If <Nothing> is left selected, the measurement results for Image Switching will be NG. Be sure to select one other than <Nothing>.
- For processing items for selectable Camera Image Input or Compensate Image and image No., refer to the table below. For details, refer to *Macro Reference - List of Image Numbers* in the *Vision System FH Series Macro Customize Functions Programming Manual (Cat. No. Z367)*.

item	Image No.	Image
Camera Image Input	0	Camera image
Camera Image Input FH	0	Camera image
Camera Image Input FHV	0	Camera image
Camera Image Input HDR	0	Camera image
Camera Image Input HDR Lite	0	Camera image
Photometric Stereo Image Input	0	Output image
	1	Shape image 1
	2	Shape image 2
	3	Shape image 3
	4	Texture image
	16	Captured image 1
	:	:
	23	Captured image 8
Position Compensation	0	Position compensated image
Filtering	0	Filtered image
Background Suppression	0	Background suppressed image
Brightness Correct Filter	0	Brightness corrected image
Color Gray Filter	0	Color gray image
Extract Color Filter	0	Color extracted image
Anti Color Shading	0	Anti color shading image
Stripes Removal Filter II	0	Stripes removed image
Polar Transformation	0	Polar transformed image
Trapezoidal Correction	0	Trapezoidal corrected image
Machine Simulator	0	Axis shifted image
Image Subtraction	0	Subtraction image
Advanced filter	0	Output image 0
	1	Output image 1
	2	Output image 2
	3	Output image 3
Panorama	0	Panorama image

2

Click **OK**.

The settings are completed.

1-10-2 Key Points for Test Measurement and Adjustment (Measurement Image Switching)

The image specified in the Sub-image number in the image display setting is displayed in the *Image Display* area.

Sub-image number	Description of image to be displayed
0	Reset image
1	Measurement image

1-10-3 External Reference Tables (Measurement Image Switching)

No.	Data name	Data ident	Set/Get	Data range
0	Judge	judge	Get only	0: No judgment (unmeasured), 1: Judgment result OK, -1: Judgment result NG, -10: Error (image format mismatch), -11: Error (unregistered model), -12: Error (insufficient memory), -20: Error (other errors)
120	Target unit	unitNo	Set/Get	Unit that outputs images subject to reset. -1 to 9,999 -1:No setting
121	Image no	imageNo	Set/Get	Image number: 0 to 9,999

1-11 Multi-trigger Imaging

This allows you to capture images multiple times at your defined timing and to perform each measurement in parallel. As adding this processing item in your measurement flow, Multi-trigger Imaging, Multi-trigger Imaging Task, Camera Image Input FH/FHV, and Multi-trigger Imaging End will be added as a group. Place Multi-trigger Imaging to the top of the measurement flow.

Multi-trigger Imaging, Multi-trigger Imaging Task, and Multi-trigger Imaging End cannot be used alone. Be sure to use them as a group.

For details, refer to *Changing the System Environment - Multi-trigger Imaging Function* in the *Vision System FH/FHV Series User's Manual (Cat. No. Z365)*.

Used in the Following Case

When capturing images multiple times at any timing and performing each measurement in parallel.

Example:

For a horizontally long workpiece, this item performs capturing processing multiple times at any timing. While performing imaging processing multiple times, it performs each measurement in parallel. After that, with the measurement results, measurement in the following is processed. After that, the following processing items process measurements with the measurement results.

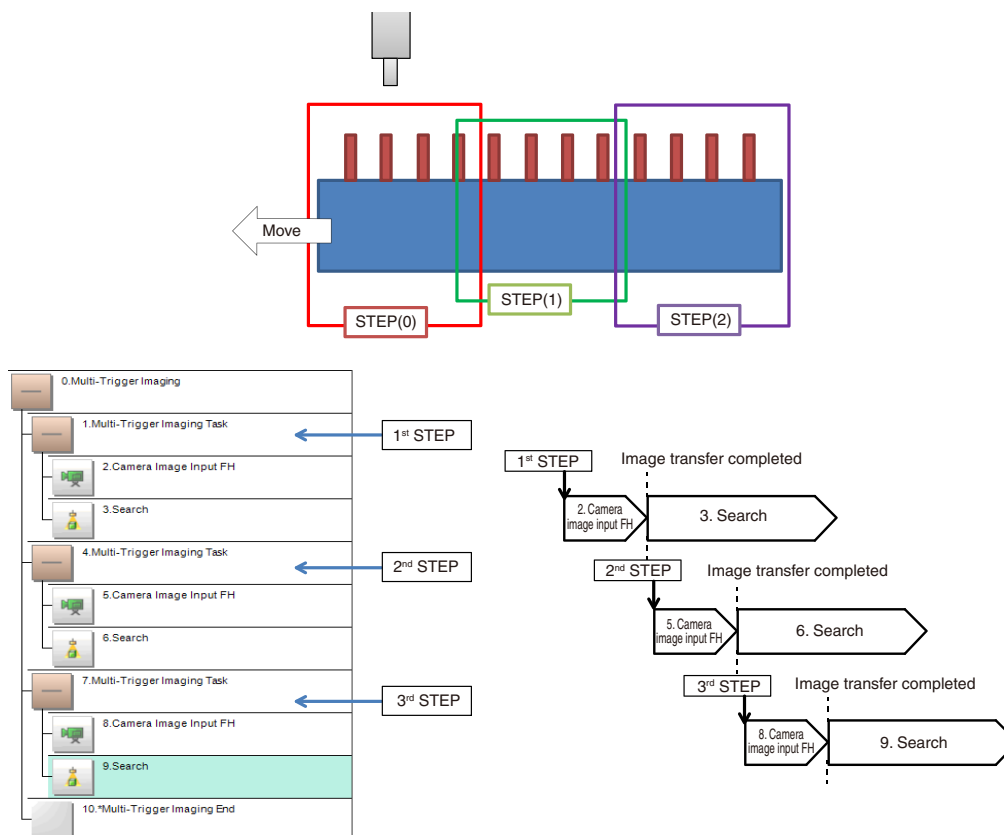



Precautions for Correct Use

- Only one camera can be used in a *Multi-Trigger Imaging Task* processing item. *Camera Switching* cannot be used.
- Multi-trigger Imaging is unavailable when the operating mode is set to *Double Speed Multi-input*.
- Be sure to place *Multi-trigger Imaging* processing item to the top (unit 0) in the measurement flow.
- Be sure to place *Multi-trigger Imaging* processing item only once in one measurement flow.
- Signals that are available for an imaging timing are STEP signal for parallel and Trigger signal for EtherCAT. In measurement triggered by other than these signals or control commands, but the measurement flow is automatically performed without waiting for the STEP signal as usual.
- When the Image mode of the Image Window is *Through*, even if inputting STEP signal the measurement flow is automatically performed without waiting for the STEP signal as usual.

1-11-1 Mode and Timeout (Multi-Trigger Imaging)

Set the Mode and Timeout of Multi-trigger Imaging processing item.

For details, refer to *Multi-trigger Imaging Function* in the *Vision System FH/FHV Series User's Manual* (Cat. No. Z365).

- 1 On the Main Window (Layout 0), select **Function – Edit flow**.

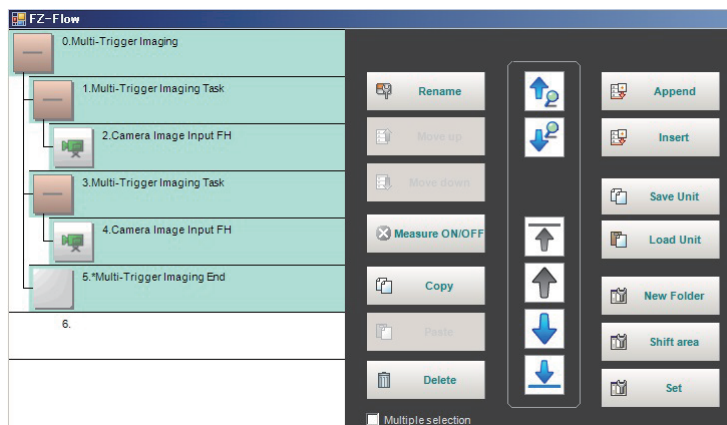

- 2 Select **Multi-trigger Imaging** processing item.
- 3 Click **Set**.
- 4 Set *Mode* and *Timeout*.

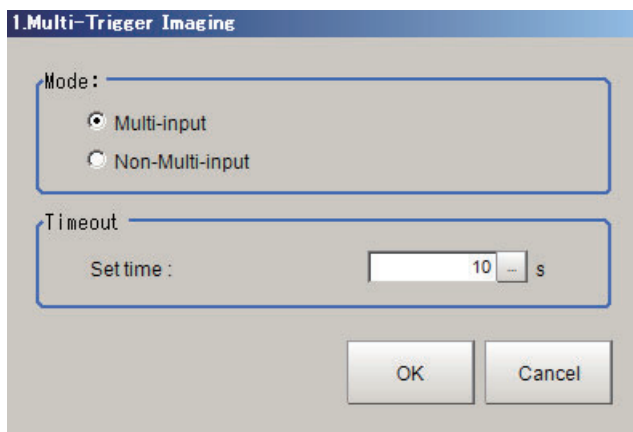

Setting item	Setting value [Factory default]	Description
Mode	<ul style="list-style-type: none"> • [Multi-input] • Non-Multi-input 	Set the processing mode of Multi-trigger Imaging Task. <ul style="list-style-type: none"> • Multi-input mode: The Image Input Processing Unit in a Multi-Trigger Imaging Task operates according to the camera settings of the Image Input Processing Unit of the first Multi-Trigger Imaging Task • Non-Multi-input: Operates according to the camera settings of each Image Input Processing Unit. Since the camera settings are changed each time the Image Input Processing Unit is executed, the OFF time of the READY signal is several milliseconds longer compared to Multi-input mode.
Timeout	1 to 60 [s] [10]	Set the time for timeout of Multi-trigger Imaging Task block. It is a wait time between a Multi-trigger Imaging Task and the next one. When a STEP signal is not input within the timeout time after the READY signal turns ON, the Multi-trigger Imaging unit judgment will be NG.



Precautions for Correct Use

- For restrictions on Multi-trigger Imaging and Multi-trigger Imaging Task, refer to *10-4-2 Restrictions* in the *Vision System FH/FHV Series User's Manual (Cat. No. Z365)*.
- There are restrictions below when FZ-FQ □□□□ camera is used with its light ON.
 - All Camera Image Input processing items operate with the settings for the Camera Image Input of the first Multi-trigger Imaging Task in the flow.
 - The system operates in non-Multi-input mode. (It takes a little bit longer time to turn ON the READY signal).
 - When the light of FZ-FQ □□□□ camera is OFF, the camera operates in the same way as other camera does.
- For *Mode*, do not use scene variables or system-defined variables.

1-11-2 Key Points for Adjustment

Select the adjustment method referring to the following points.

When there is poor image capture results

Parameter to be adjusted	Remedy
Edit flow	<p>Verify that there are no additional Camera Image Input related processing units between a Multi-Trigger Imaging block and the first Multi-Trigger Imaging task. If there is a Camera Image Input related processing unit in this position, image capture results will not be correct. Ensure that Camera Image Input related processing units are placed within a Multi-Trigger Imaging task.</p> <p>Is a <i>Camera Switching</i> processing item possibly placed in a <i>Multi-Trigger Imaging Task</i>? Only one camera can be used in a <i>Multi-Trigger Imaging Task</i> processing item. <i>Camera Switching</i> cannot be used.</p> <p>When the number of Multi-Trigger Imaging tasks does not match the number of STEP signal input, Verify that the number of Multi-Trigger Imaging tasks and the number of STEP signal inputs match each other and try image capture again.</p>

1-11-3 External Reference Tables (Multi-Trigger Imaging)

No.	Data name	Data ident	Set/Get	Data range
None	Judge	judge	Get only	0: No judgment (unmeasured), 1: Judgment result OK, -1: Judgment result NG, -10: Error (image format mismatch), -11: Error (unregistered model), -12: Error (insufficient memory), -20: Error (other errors)
None	Timeout	timeout	Set/Get	1,000 to 60,000
None	Mode	multiInput	Set/Get	0: Non-Multi-input, 1: Multi-input

1-12 Multi-trigger Imaging Task

This allows you to capture images multiple times at your defined timing and to perform each measurement in parallel. As adding this processing item in your measurement flow, Multi-trigger Imaging Task and Camera Image Input FH/FHV will be added as a group. The Multi-trigger Imaging Task does not require setting. Insert this processing item to the top of the processing which requires imaging for multiple times.

Multi-trigger Imaging, Multi-trigger Imaging Task, and Multi-trigger Imaging End cannot be used alone. Be sure to use them as a group.

For details, refer to *Changing the System Environment - Multi-trigger Imaging Function* in the *Vision System FH/FHV Series User's Manual (Cat. No. Z365)*.

Used in the Following Case

When capturing images multiple times at any timing and performing each measurement in parallel.

Example:

For a horizontally long workpiece, this item performs capturing processing multiple times at any timing. While performing imaging processing multiple times, it performs each measurement in parallel. After that, with the measurement results, measurement in the following is processed. After that, the following processing items process measurements with the measurement results.

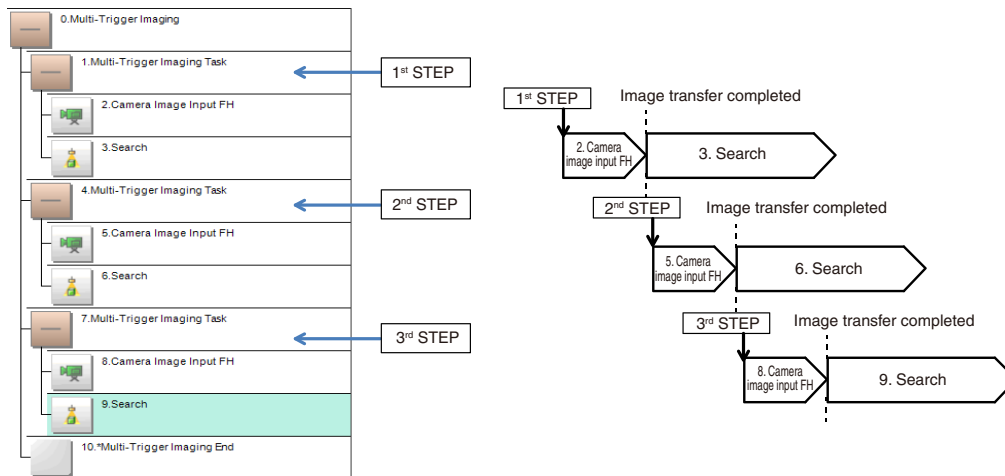
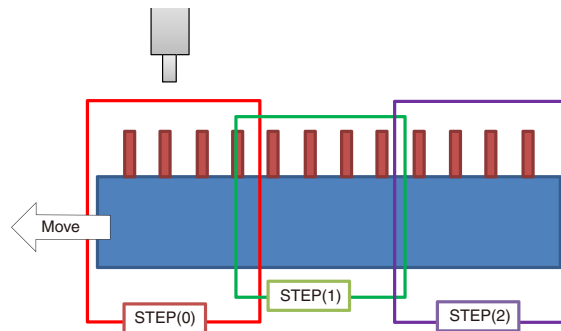



Precautions for Correct Use

- Only one camera can be used in a *Multi-Trigger Imaging Task* processing item. *Camera Switching* cannot be used.
 - Signals that are available for an imaging timing are STEP signal for parallel and Trigger signal for EtherCAT. In measurement triggered by other than these signals or control commands, but the measurement flow is automatically performed without waiting for the STEP signal as usual.
 - When the Image mode of the Image Window is *Through*, even if inputting STEP signal the measurement flow is automatically performed without waiting for the STEP signal as usual.
-

2

Inspecting and Measuring

This chapter describes how to set up the processing items that execute measurement. In addition, key points for adjustment addressing unstable measurement results and shortening measurement time will also be introduced.

2-1	Search	2-8
2-1-1	Settings Flow (Search)	2-9
2-1-2	Model Registration (Search)	2-9
2-1-3	Region Setting (Search)	2-12
2-1-4	Detection Point (Search).....	2-13
2-1-5	Reference Setting (Search)	2-14
2-1-6	Measurement Parameters (Search)	2-16
2-1-7	Output Parameters (Search).....	2-18
2-1-8	Key Points for Test Measurement and Adjustment (Search)	2-18
2-1-9	Measurement Results for Which Output Is Possible (Search).....	2-20
2-1-10	External Reference Tables (Search).....	2-21
2-2	Search II	2-24
2-2-1	Settings Flow (Search II)	2-25
2-2-2	Model Registration (Search II)	2-26
2-2-3	Region Setting (Search II)	2-29
2-2-4	Detection Point (Search II).....	2-29
2-2-5	Reference Setting (Search II)	2-30
2-2-6	Measurement Parameters (Search II)	2-31
2-2-7	Output Parameters (Search II).....	2-33
2-2-8	Key Points for Test Measurement and Adjustment (Search II).....	2-33
2-2-9	Measurement Results for Which Output Is Possible (Search II).....	2-35
2-2-10	External Reference Tables (Search II).....	2-36
2-3	Flexible Search	2-39
2-3-1	Settings Flow (Flexible Search)	2-40
2-3-2	Model Registration (Flexible Search).....	2-41
2-3-3	Region Setting (Flexible Search)	2-43
2-3-4	Measurement Parameters (Flexible Search)	2-44
2-3-5	Output Parameters (Flexible Search)	2-45
2-3-6	Key Points for Test Measurement and Adjustment (Flexible Search).....	2-46
2-3-7	Measurement Results for Which Output Is Possible (Flexible Search)	2-47
2-3-8	External Reference Tables (Flexible Search)	2-48
2-4	Sensitive Search	2-50
2-4-1	Settings Flow (Sensitive Search).....	2-50
2-4-2	Model Registration (Sensitive Search)	2-52
2-4-3	Region Setting (Sensitive Search).....	2-55
2-4-4	Detection Point (Sensitive Search)	2-55

2-4-5	Reference Setting (Sensitive Search).....	2-57
2-4-6	Measurement Parameters (Sensitive Search).....	2-59
2-4-7	Output Parameters (Sensitive Search).....	2-60
2-4-8	Key Points for Test Measurement and Adjustment (Sensitive Search).....	2-60
2-4-9	Measurement Results for Which Output Is Possible (Sensitive Search).....	2-62
2-4-10	External Reference Tables (Sensitive Search).....	2-63
2-5	ECM Search	2-67
2-5-1	Settings Flow (ECM Search).....	2-68
2-5-2	Model Registration (ECM Search).....	2-69
2-5-3	Error Model Registration (ECM Search).....	2-72
2-5-4	Region Setting (ECM Search).....	2-72
2-5-5	Detection Point (ECM Search).....	2-73
2-5-6	Reference Setting (ECM Search).....	2-74
2-5-7	Measurement Parameters (ECM Search).....	2-77
2-5-8	Output Parameters (ECM Search).....	2-78
2-5-9	Key Points for Test Measurement and Adjustment (ECM Search).....	2-79
2-5-10	Measurement Results for Which Output Is Possible (ECM Search).....	2-80
2-5-11	External Reference Tables (ECM Search).....	2-81
2-6	EC Circle Search	2-84
2-6-1	Settings Flow (EC Circle Search).....	2-85
2-6-2	Circle Setting (EC Circle Search).....	2-86
2-6-3	Region Setting (EC Circle Search).....	2-87
2-6-4	Reference Setting (EC Circle Search).....	2-87
2-6-5	Color Specification (EC Circle Search).....	2-89
2-6-6	Measurement Parameters (EC Circle Search).....	2-89
2-6-7	Output Parameters (EC Circle Search).....	2-91
2-6-8	Key Points for Test Measurement and Adjustment (EC Circle Search).....	2-92
2-6-9	Measurement Results for Which Output Is Possible (EC Circle Search).....	2-93
2-6-10	External Reference Tables (EC Circle Search).....	2-93
2-7	Shape Search II	2-96
2-7-1	Settings Flow (Shape Search II).....	2-97
2-7-2	Model Registration (Shape Search II).....	2-98
2-7-3	Region Setting (Shape Search II).....	2-100
2-7-4	Detection Point (Shape Search II).....	2-100
2-7-5	Reference Setting (Shape Search II).....	2-101
2-7-6	Measurement Parameters (Shape Search II).....	2-103
2-7-7	Output Parameters (Shape Search II).....	2-105
2-7-8	Key Points for Test Measurement and Adjustment (Shape Search II).....	2-106
2-7-9	Measurement Results for Which Output Is Possible (Shape Search II).....	2-107
2-7-10	External Reference Tables (Shape Search II).....	2-108
2-8	Shape Search III	2-111
2-8-1	Settings Flow (Shape Search III).....	2-112
2-8-2	Model (Shape Search III).....	2-113
2-8-3	Region Setting (Shape Search III).....	2-120
2-8-4	Detection Point (Shape Search III).....	2-121
2-8-5	Reference Setting (Shape Search III).....	2-122
2-8-6	Measurement parameter (Shape Search III).....	2-124
2-8-7	Output Parameters (Shape Search III).....	2-128
2-8-8	Key Points for Test Measurement and Adjustment (Shape Search III).....	2-129
2-8-9	Measurement Results for Which Output is Possible (Shape Search III).....	2-131
2-8-10	External Reference Tables (Shape Search III).....	2-132
2-9	Ec Corner	2-138
2-9-1	Settings Flow (Ec Corner).....	2-138
2-9-2	Region Setting (Ec Corner).....	2-139
2-9-3	Reference Setting (Ec Corner).....	2-140
2-9-4	Line Extraction (Ec Corner).....	2-141
2-9-5	Corner Extraction (Ec Corner).....	2-143
2-9-6	Measurement Parameters (Ec Corner).....	2-145
2-9-7	Output Parameters (Ec Corner).....	2-146
2-9-8	Key Points for Test Measurement and Adjustment (Ec Corner).....	2-147
2-9-9	Measurement Results for Which Output Is Possible (Ec Corner).....	2-148

2-9-10	External Reference Tables (Ec Corner)	2-148
2-10	Ec Cross	2-152
2-10-1	Settings Flow (Ec Cross)	2-153
2-10-2	Region Setting (Ec Cross)	2-154
2-10-3	Reference Setting (Ec Cross)	2-155
2-10-4	Line Extraction (Ec Cross)	2-156
2-10-5	Cross Extraction (Ec Cross)	2-158
2-10-6	Measurement Parameters (Ec Cross)	2-159
2-10-7	Output Parameters (Ec Cross)	2-160
2-10-8	Key Points for Test Measurement and Adjustment (Ec Cross)	2-161
2-10-9	Measurement Results for Which Output Is Possible (Ec Cross)	2-162
2-10-10	External Reference Tables (Ec Cross)	2-163
2-11	Classification	2-166
2-11-1	Settings Flow (Classification)	2-167
2-11-2	Model Registration (Classification)	2-168
2-11-3	Region Setting (Classification)	2-171
2-11-4	Measurement Parameters (Classification)	2-171
2-11-5	Output Parameters (Classification)	2-172
2-11-6	Key Points for Test Measurement and Adjustment (Classification)	2-174
2-11-7	Measurement Results for Which Output Is Possible (Classification)	2-175
2-11-8	External Reference Tables (Classification)	2-176
2-12	Edge Position	2-178
2-12-1	Settings Flow (Edge Position)	2-179
2-12-2	Region Setting (Edge Position)	2-180
2-12-3	Edge Color Specification - For Color Cameras Only (Edge Position)	2-181
2-12-4	Reference Setting (Edge Position)	2-182
2-12-5	Measurement Parameters (Edge Position)	2-184
2-12-6	Output Parameters (Edge Position)	2-187
2-12-7	Key Points for Test Measurement and Adjustment (Edge Position)	2-188
2-12-8	Measurement Results for Which Output Is Possible (Edge Position)	2-189
2-12-9	External Reference Tables (Edge Position)	2-189
2-13	Edge Pitch	2-192
2-13-1	Settings Flow (Edge Pitch)	2-193
2-13-2	Region Setting (Edge Pitch)	2-194
2-13-3	Edge Color Specification - For Color Cameras Only (Edge Pitch)	2-194
2-13-4	Measurement Parameters (Edge Pitch)	2-195
2-13-5	Output Parameters (Edge Pitch)	2-197
2-13-6	Key Points for Test Measurement and Adjustment (Edge Pitch)	2-198
2-13-7	Measurement Results for Which Output Is Possible (Edge Pitch)	2-199
2-13-8	External Reference Tables (Edge Pitch)	2-199
2-14	Scan Edge Position	2-202
2-14-1	Settings Flow (Scan Edge Position)	2-203
2-14-2	Region Setting (Scan Edge Position)	2-204
2-14-3	Edge Color Specification - For Color Cameras Only (Scan Edge Position)	2-205
2-14-4	Reference Setting (Scan Edge Position)	2-206
2-14-5	Measurement Parameters (Scan Edge Position)	2-208
2-14-6	Judgment Conditions (Scan Edge Position)	2-212
2-14-7	Output Parameters (Scan Edge Position)	2-213
2-14-8	Key Points for Test Measurement and Adjustment (Scan Edge Position)	2-214
2-14-9	Measurement Results for Which Output Is Possible (Scan Edge Position)	2-215
2-14-10	External Reference Tables (Scan Edge Position)	2-216
2-15	Scan Edge Width	2-220
2-15-1	Settings Flow (Scan Edge Width)	2-221
2-15-2	Region Setting (Scan Edge Width)	2-221
2-15-3	Edge Color Specification - For Color Cameras Only (Scan Edge Width)	2-223
2-15-4	Measurement Parameters (Scan Edge Width)	2-224
2-15-5	Judgment Conditions (Scan Edge Width)	2-227
2-15-6	Output Parameters (Scan Edge Width)	2-228
2-15-7	Key Points for Test Measurement and Adjustment (Scan Edge Width)	2-228
2-15-8	Measurement Results for Which Output Is Possible (Scan Edge Width)	2-229
2-15-9	External Reference Tables (Scan Edge Width)	2-230

2-16	Circular Scan Edge Position	2-233
2-16-1	Settings Flow (Circular Scan Edge Position)	2-234
2-16-2	Region Setting (Circular Scan Edge Position)	2-235
2-16-3	Edge Color Specification - For Color Cameras Only (Circular Scan Edge Position)	2-236
2-16-4	Reference Setting (Circular Scan Edge Position)	2-237
2-16-5	Measurement Parameters (Circular Scan Edge Position)	2-239
2-16-6	Judgment Conditions (Circular Scan Edge Position)	2-242
2-16-7	Output Parameters (Circular Scan Edge Position)	2-243
2-16-8	Key Points for Test Measurement and Adjustment (Circular Scan Edge Position)	2-244
2-16-9	Measurement Results for Which Output Is Possible (Circular Scan Edge Position)	2-245
2-16-10	External Reference Tables (Circular Scan Edge Position)	2-246
2-17	Circular Scan Edge Width	2-250
2-17-1	Settings Flow (Circular Scan Edge Width)	2-250
2-17-2	Region Setting (Circular Scan Edge Width)	2-251
2-17-3	Edge Color Specification - For Color Cameras Only (Circular Scan Edge Width)	2-253
2-17-4	Measurement Parameters (Circular Scan Edge Width)	2-254
2-17-5	Judgement Conditions (Circular Scan Edge Width)	2-257
2-17-6	Output Parameters (Circular Scan Edge Width)	2-258
2-17-7	Key Points for Test Measurement and Adjustment (Circular Scan Edge Width)	2-258
2-17-8	Measurement Results for Which Output Is Possible (Circular Scan Edge Width)	2-259
2-17-9	External Reference Tables (Circular Scan Edge Width)	2-260
2-18	Intersection	2-263
2-18-1	Settings Flow (Intersection)	2-263
2-18-2	Region Setting (Intersection)	2-264
2-18-3	Edge Color Specification - For Color Cameras Only (Intersection)	2-265
2-18-4	Reference Setting (Intersection)	2-266
2-18-5	Measurement Parameters (Intersection)	2-268
2-18-6	Judgement Condition (Intersection)	2-272
2-18-7	Output Parameters (Intersection)	2-272
2-18-8	Key Points for Test Measurement and Adjustment (Intersection)	2-273
2-18-9	Measurement Results for Which Output Is Possible (Intersection)	2-274
2-18-10	External Reference Tables (Intersection)	2-275
2-19	Color Data	2-282
2-19-1	Settings Flow (Color Data)	2-283
2-19-2	Region Setting (Color Data)	2-283
2-19-3	Mask Setting (Color Data)	2-284
2-19-4	Measurement Parameters (Color Data)	2-287
2-19-5	Judgement Condition (Color Data)	2-288
2-19-6	Output parameter (Color Data)	2-290
2-19-7	Key Points for Test Measurement and Adjustment (Color Data)	2-290
2-19-8	Measurement Results for Which Output Is Possible (Color Data)	2-291
2-19-9	External Reference Tables (Color Data)	2-292
2-20	Gravity and Area	2-297
2-20-1	Settings Flow (Gravity and Area)	2-298
2-20-2	Color Specification (Gravity and Area)	2-299
2-20-3	Binarization (Gravity and Area)	2-301
2-20-4	Region Setting (Gravity and Area)	2-301
2-20-5	Mask Setting (Gravity and Area)	2-302
2-20-6	Reference Setting (Gravity and Area)	2-305
2-20-7	Measurement Parameters (Gravity and Area)	2-307
2-20-8	Output Parameters (Gravity and Area)	2-309
2-20-9	Key Points for Test Measurement and Adjustment (Gravity and Area)	2-309
2-20-10	Measurement Results for Which Output Is Possible (Gravity and Area)	2-310
2-20-11	External Reference Tables (Gravity and Area)	2-311
2-21	Labeling	2-317

2-21-1	Settings Flow (Labeling)	2-318
2-21-2	Color Specification (Labeling)	2-319
2-21-3	Binarization (Labeling)	2-321
2-21-4	Region Setting (Labeling)	2-322
2-21-5	Mask Setting (Labeling)	2-323
2-21-6	Reference Setting (Labeling)	2-326
2-21-7	Measurement Parameters (Labeling)	2-328
2-21-8	Judgement Conditions (Labeling)	2-331
2-21-9	Output Parameters (Labeling)	2-332
2-21-10	Key Points for Test Measurement and Adjustment (Labeling).....	2-333
2-21-11	Measurement Results for Which Output Is Possible (Labeling)	2-334
2-21-12	External Reference Tables (Labeling).....	2-335
2-22	Label Data	2-343
2-22-1	Settings Flow (Label Data)	2-344
2-22-2	Setting (Label Data)	2-344
2-22-3	Output Parameters (Label Data).....	2-345
2-22-4	Key Points for Test Measurement and Adjustment (Label Data)	2-346
2-22-5	Measurement Results for Which Output Is Possible (Label Data).....	2-346
2-22-6	External Reference Tables (Label Data).....	2-347
2-23	Defect	2-348
2-23-1	Settings Flow (Defect)	2-349
2-23-2	Region Setting (Defect)	2-349
2-23-3	Mask Setting (Defect)	2-350
2-23-4	Measurement Parameters (Defect)	2-354
2-23-5	Output parameter (Defect).....	2-357
2-23-6	Key Points for Test Measurement and Adjustment (Defect)	2-357
2-23-7	Measurement Results for Which Output Is Possible (Defect).....	2-358
2-23-8	External Reference Tables (Defect).....	2-359
2-24	Precise Defect	2-364
2-24-1	Settings Flow (Precise Defect)	2-365
2-24-2	Region Setting (Precise Defect)	2-365
2-24-3	Mask Setting (Precise Defect)	2-367
2-24-4	Measurement Parameters (Precise Defect)	2-370
2-24-5	Judgement Condition (Precise Defect)	2-373
2-24-6	Output parameter (Precise Defect).....	2-374
2-24-7	Key Points for Test Measurement and Adjustment (Precise Defect)	2-375
2-24-8	Measurement Results for Which Output Is Possible (Precise Defect).....	2-376
2-24-9	External Reference Tables (Precise Defect).....	2-377
2-25	Fine Matching	2-383
2-25-1	Settings Flow (Fine Matching)	2-384
2-25-2	Model Registration (Fine Matching)	2-385
2-25-3	Difference Image Display (Fine Matching).....	2-387
2-25-4	Measurement Parameters (Fine Matching)	2-388
2-25-5	Output Parameters (Fine Matching)	2-391
2-25-6	Key Points for Test Measurement and Adjustment (Fine Matching).....	2-392
2-25-7	Measurement Results for Which Output Is Possible (Fine Matching)	2-393
2-25-8	External Reference Tables (Fine Matching).....	2-393
2-26	Character Inspection	2-395
2-26-1	Settings Flow (Character Inspection).....	2-395
2-26-2	Dictionary Parameters (Character Inspection).....	2-396
2-26-3	Region Setting (Character Inspection).....	2-397
2-26-4	Measurement Parameters (Character Inspection).....	2-397
2-26-5	Output Parameters (Character Inspection).....	2-399
2-26-6	Key Points for Test Measurement and Adjustment (Character Inspection)	2-403
2-26-7	Measurement Results for Which Output Is Possible (Character In- spection).....	2-404
2-26-8	External Reference Tables (Character Inspection).....	2-405
2-27	Date Verification	2-408
2-27-1	Settings Flow (Date Verification).....	2-408
2-27-2	Verification Parameters (Date Verification)	2-409
2-27-3	Date Parameters (Date Verification)	2-410

2-27-4	Code Parameters (Date Verification)	2-413
2-27-5	Output parameter (Date Verification)	2-417
2-27-6	Key Points for Test Measurement and Adjustment (Date Verification)	2-418
2-27-7	Measurement Results for Which Output Is Possible (Date Verification).....	2-418
2-27-8	External Reference Tables (Date Verification)	2-418
2-28	Model Dictionary	2-421
2-28-1	Settings Flow (Model Dictionary)	2-421
2-28-2	Model Registration (Model Dictionary).....	2-422
2-28-3	Measurement Parameters (Model Dictionary)	2-425
2-28-4	Model Automatic Registration (Model Dictionary).....	2-425
2-28-5	Key Points for Test Measurement and Adjustment (Model Dictionary).....	2-427
2-28-6	Measurement Results for Which Output Is Possible (Model Dictionary)	2-427
2-28-7	External Reference Tables (Model Dictionary)	2-428
2-29	2D Code.....	2-429
2-29-1	Settings Flow (2D Code).....	2-429
2-29-2	Region Setting (2D Code).....	2-430
2-29-3	Measurement Parameters (2D Code).....	2-430
2-29-4	Refernce Settings (2D Code).....	2-435
2-29-5	Vertices Reference Setting (2D Code).....	2-437
2-29-6	Results Settings (2D Code)	2-439
2-29-7	Output Parameters (2D Code).....	2-439
2-29-8	Output of Character String with Result Output (I/O) with EtherNet/IP	2-444
2-29-9	Output of Character String with Result Output (I/O) with EtherCAT	2-444
2-29-10	Output of Character String with Result Output (I/O) with PROFINET	2-445
2-29-11	Key Points for Test Measurement and Adjustment (2D Code)	2-445
2-29-12	Measurement Results for Which Output Is Possible (2D Code).....	2-447
2-29-13	External Reference Tables (2D Code).....	2-450
2-30	2D Code II.....	2-456
2-30-1	Settings Flow (2D Code II).....	2-456
2-30-2	Region Setting (2D Code II).....	2-457
2-30-3	Measurement Parameters (2D Code II).....	2-457
2-30-4	Refernce Settings (2D Code II).....	2-460
2-30-5	Vertices Reference Setting (2D Code II).....	2-462
2-30-6	Results Settings (2D Code II)	2-464
2-30-7	Output Parameters (2D Code II).....	2-464
2-30-8	Key Points for Test Measurement and Adjustment (2D Code II)	2-466
2-30-9	Measurement Results for Which Output Is Possible (2D Code II).....	2-468
2-30-10	External Reference Tables (2D Code II)	2-471
2-31	Barcode	2-477
2-31-1	Settings Flow (Barcode)	2-477
2-31-2	Region Setting (Barcode)	2-478
2-31-3	Measurement Parameters (Barcode)	2-478
2-31-4	Results Settings (Barcode).....	2-482
2-31-5	Output Parameters (Barcode).....	2-482
2-31-6	Key Points for Test Measurement and Adjustment (Barcode)	2-486
2-31-7	Measurement Results for Which Output Is Possible (Barcode).....	2-487
2-31-8	External Reference Tables (Barcode).....	2-489
2-32	OCR User Dictionary.....	2-492
2-32-1	Settings Flow (OCR User Dictionary)	2-492
2-32-2	Dictionary Reference (OCR User Dictionary)	2-493
2-32-3	Dictionary Operation (OCR User Dictionary)	2-496
2-32-4	Key Points for Test Measurement and Adjustment (OCR User Dictionary)	2-497
2-33	OCR	2-498
2-33-1	Settings Flow (OCR).....	2-499
2-33-2	Region Setting (OCR).....	2-501
2-33-3	Measurement Parameters (OCR).....	2-502
2-33-4	Judgement Conditions (OCR).....	2-512
2-33-5	Dictionary Settings (OCR)	2-519
2-33-6	Dictionary Registration (OCR)	2-522
2-33-7	Date Parameters (OCR)	2-523
2-33-8	Code Parameters (OCR)	2-527

2-33-9	Output Parameters (OCR)	2-530
2-33-10	Key Points for Test Measurement and Adjustment (OCR)	2-535
2-33-11	Measurement Results for Which Output is Possible (OCR)	2-537
2-33-12	External Reference Tables (OCR)	2-538
2-34	Circle Angle	2-546
2-34-1	Settings Flow (Circle Angle)	2-547
2-34-2	Region Setting (Circle Angle)	2-548
2-34-3	Output Parameters (Circle Angle)	2-550
2-34-4	Key Points for Test Measurement and Adjustment (Circle Angle)	2-551
2-34-5	Measurement Results for Which Output Is Possible (Circle Angle)	2-551
2-34-6	External Reference Tables (Circle Angle)	2-552
2-35	Glue Bead Inspection	2-554
2-35-1	Settings Flow (Glue Bead Inspection)	2-554
2-35-2	Color Specification (Glue Bead Inspection)	2-555
2-35-3	Binarization (Glue Bead Inspection)	2-557
2-35-4	Region Setting (Glue Bead Inspection)	2-558
2-35-5	Measurement Parameters (Glue Bead Inspection)	2-561
2-35-6	Output Parameters (Glue Bead Inspection)	2-563
2-35-7	Key Points for Test Measurement and Adjustment (Glue Bead Inspection)	2-564
2-35-8	Measurement Results for Which Output is Possible (Glue Bead Inspection)	2-565
2-35-9	External Reference Tables (Glue Bead Inspection)	2-566
2-36	AI Fine Matching	2-575
2-36-1	Settings Flow (AI Fine Matching)	2-577
2-36-2	Image preparations	2-578
2-36-3	Normal image learning	2-585
2-36-4	Setting optimization	2-593
2-36-5	Input Parameters (AI Fine Matching)	2-610
2-36-6	Output parameters (AI Fine Matching)	2-614
2-36-7	Key Points for Test Measurement and Adjustment (AI Fine Matching)	2-614
2-36-8	External reference data (AI Fine Matching)	2-618

2-1 Search

Register the feature sections of the measurement object as an image pattern (model), then find the most similar part to these models from the input images to detect the position.

The correlation value showing the degree of similarity, measurement object position, and inclination can be output.

Used in the Following Case

When identifying the shape of measurement objects (for detecting defects or foreign matter):

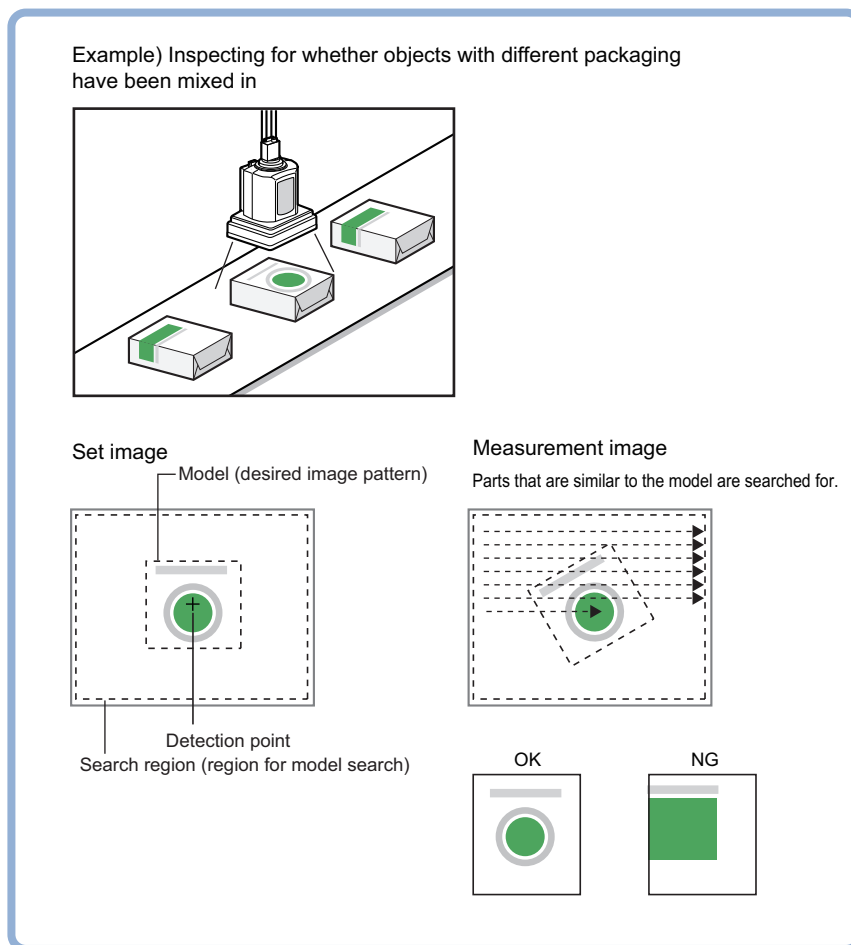

Precautions for Correct Use

Processing is different for color images and monochrome images. When the camera type used in the previous setup was changed to color or monochrome type, perform the settings again.



Additional Information

Search processing basic concepts

For details, refer to *Appendixes Measurement Mechanism Search Processing Mechanism* in the *Vision System FH/FHV Series User's Manual (Cat. No. Z365)*.

2-1-1 Settings Flow (Search)

To set Search, follow the steps below.

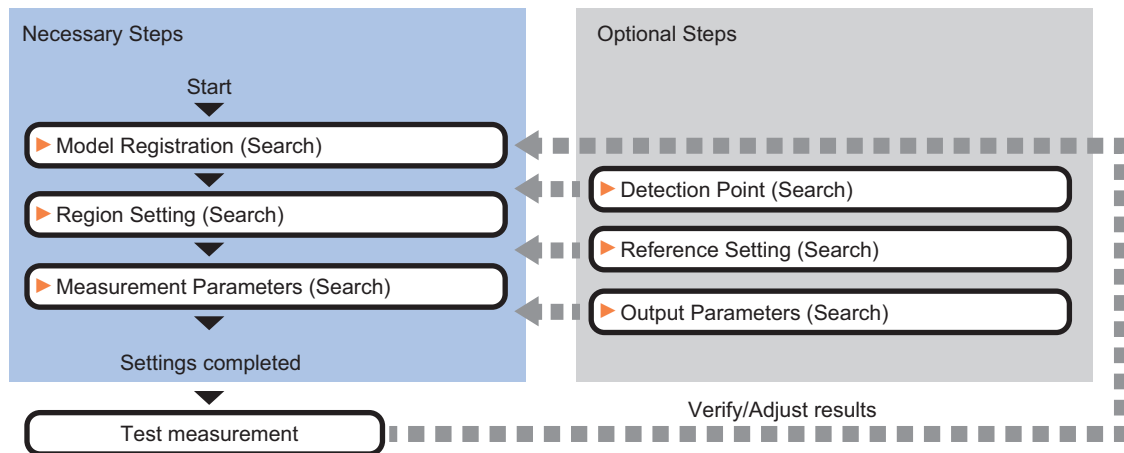

List of Search Items

Item	Description
Model	This item registers the pattern characteristic of the measurement image as a model. Model parameter values can be changed as needed to address unstable measurement results or to increase the processing speed. Normally, the factory default value will be used. <i>2-1-2 Model Registration (Search) on page 2-9</i>
Region setting	Sets the measurement area. It is possible to target the entire screen, but restricting the range can shorten the processing time. <i>2-1-3 Region Setting (Search) on page 2-12</i>
Detection point	This item can be changed as necessary. Specify a position in the model that should be used as the detection coordinates during measurement. Usually, the central position of the set model is registered as the detection coordinates. <i>2-1-4 Detection Point (Search) on page 2-13</i>
Ref. setting	This item can be changed as necessary. Specify the reference position within the camera's field of view. <i>2-1-5 Reference Setting (Search) on page 2-14</i>
Measurement parameter	Sets processing conditions for measurement and judgment conditions for measurement results. Specify the criteria to judge the measurement result if the X and Y coordinates and the correlation with the model are OK. <i>2-1-6 Measurement Parameters (Search) on page 2-16</i>
Output parameter	This item can be changed as necessary. Normally, the factory default value will be used. Use the output parameter to specify how to handle the coordinates. <i>2-1-7 Output Parameters (Search) on page 2-18</i>

2-1-2 Model Registration (Search)

Register the parts to measure as the model.

The position at the time of registration is also registered in the model information. Place the measurement object in the correct position when registering a model.



Additional Information

When a model is registered, the central coordinates of the model are registered as the detection point. A detection point is a point output as a measurement value. If multiple figures are combined, the central coordinates of the circumscribed rectangle are registered.

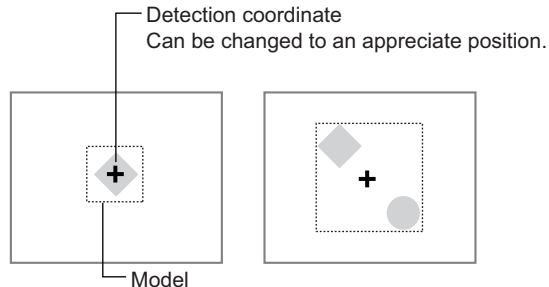

- 1 In the Item tab area, click **Model**.
When setting a new model, you do not have to click **Model**.
- 2 Use the drawing tools to specify the model registration range.
- 3 To save the entire image used for model registration, place a check at the *Save reg. model* option.

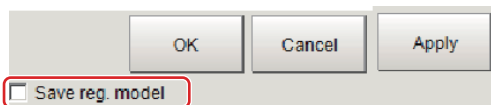

Additional Information

If you save the registered model image, you can re-register the model with the same image after model parameters are adjusted. Note that the scene data size increases when a registered model image is saved.

- 4 Click **OK** in the *Figure setting* area.
 - **OK**: Changes the settings and returns to the previous menu.
 - **Cancel**: Changes are discarded. Returns to the previous menu.
 - **Apply**: Updates the settings without leaving edit window.

Changing Model Parameters

Model parameter values can be changed as needed to address unstable measurement results or to increase the processing speed. Normally, the factory default value will be used.

After changing a setting, re-register the model.

- 1 In the *Model parameter* area, select the *Search mode*, then specify a value for each item for that mode.

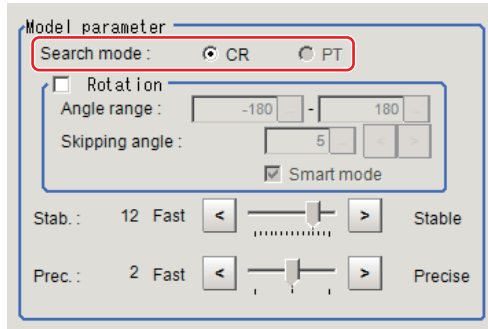

Setting item	Setting value [Factory default]	Description
Search mode	<ul style="list-style-type: none"> [CR] [PT] 	<ul style="list-style-type: none"> CR: Search for normalizing the brightness. This method can provide stable measurement when there is fluctuation in the overall brightness and when the image has low contrast. PT: Measures the degree of matching with the profile. This method can measure at higher speed when the rotation angle has a wide range. It is available only when a 0.3 megapixel color camera is connected.

- When CR is selected:

Setting item	Setting value [Factory default]	Description
Rotation	<ul style="list-style-type: none"> Checked [Unchecked] 	When the measurement object is rotating, place a check at <i>Rotation</i> and specify how many degrees the model created rotates each time and through what range of angles. A smaller skipping angle increases stability, but slows down the processing. The forward direction is clockwise.
Angle range	-180 to 180 [-180] to [180]	
Skipping angle	1 to 30 [5]	
Smart mode	<ul style="list-style-type: none"> [Checked] Unchecked 	Checking the <i>Smart mode</i> option enables a high-speed rotation search. However, the stability may be lowered when the model shape aspect ratio is large or when the NOT mask is used.
Stab.	1 to 15 The default value depend on the connected camera. [9] or [12]	Specify which is to have priority, measurement stability or speed. If lowering stability does not speed up processing, it is likely that many candidates have been detected. In this case, specify a larger value for <i>Candidate LV</i> or <i>Stab.</i> .
Prec.	1 to 3 [2]	Specify which is to have priority, measurement positional precision or speed.

- When PT is selected:

Setting item	Setting value [Factory default]	Description
Angle range	-180 to 180 [-180] to [180]	This item specifies the rotation angle range for searching. The normal direction is clockwise.

Setting item	Setting value [Factory default]	Description
Stab.	1 to 5 [3]	If lowering stability does not speed up processing, it is likely that many candidates have been detected. In this case, specify a larger value for <i>Candidate LV</i> or <i>Stab.</i> .

Displaying/Re-Registering/Deleting a Model

The buttons described in the following table are available when a model registration image is saved. You can use these buttons to reconfirm images used for model registration, or re-registering the model after adjusting detail settings.

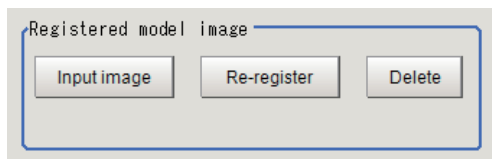

Setting item	Setting value	Description
Disp model/Input image	-	The model image display and input image display are switched.
Re-register	-	Re-registers a model using the model registration image. When model parameters are changed, you can display the model registration image and re-register. This button is available when the model registration image is displayed.
Delete	-	Deletes a model.

2-1-3 Region Setting (Search)

Use a rectangle to specify the area where the model is searched. Instead of measuring the entire input image, narrowing the measurement area shortens the processing time.

- 1** In the Item tab area, click **Region setting**.
- 2** Click **Edit**.
The *Figure Setting* area is displayed.
- 3** Specify the area in which to search for the model.
The rectangle covering the entire screen is set. Adjust the size and position of the rectangle.
- 4** Click **OK** in the *Figure setting* area.
 - **OK**: Changes the settings and returns to the previous menu.
 - **Cancel**: Changes are discarded. Returns to the previous menu.
 - **Apply**: Updates the settings without leaving edit window.

2-1-4 Detection Point (Search)

Specify a position in the model that should be used as the detection coordinates during measurement. Usually, the central position of the set model is registered as the detection point. This function is used to change to any desired position.

A detection point can be set either directly or by referencing a unit.



Additional Information

After changing the detection point coordinates to another position, re-registering the model will change it back to the center coordinates of the model.

Specifying directly

Click a position on the image you want to use as a detection point, or input coordinate data for that point.

- 1 In the Item tab area, click **Detection point**.
In the *Display* area, the current detection point is displayed with a crosshair cursor.



- 2 In the *Method* area, select *Numerical*.

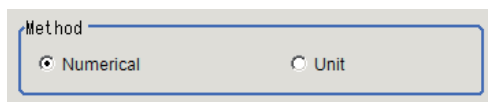

- 3 Click the position to be set as the detection point.



Additional Information

Displaying the image enlarged makes this clicking easier.
For details, refer to *Appendixes Basic Knowledge about Operations Using the Zoom Function in the Vision System FH/FHV Series User's Manual (Cat. No. Z365)*.

- 4 Make fine adjustments using numeric value inputs or the arrow buttons as required.

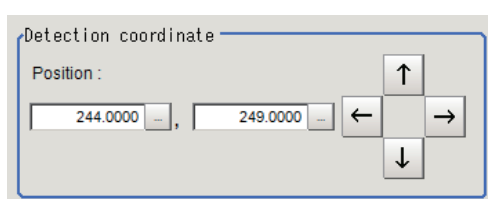

Referencing a unit

Set a detection point by referencing a detection point unit with registered X coordinate, Y coordinate and angle data.

- 1 In the Item tab area, click **Detection point**.
In the *Display* area, the current detection point is displayed with a crosshair cursor.
- 2 In the *Method* area, select *Unit*.



- 3 In the *Unit* area, select a detection point unit in the scene.

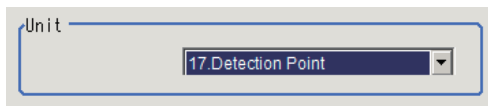

Performing the next measurement will display the detection point.

2-1-5 Reference Setting (Search)

When the model is set, this position is automatically set at the same time as the reference position. This item can be set to change the reference position to any desired position. This is handy for measuring the position deviation from a certain position.

A reference position can be set either directly or by referencing a unit.

Specifying Directly

Click a position on the image you want to use as a reference position, or input coordinate data for that point.

- 1 In the Item tab area, click **Ref. setting**.
In the *Display* area, the current reference position will be displayed as the crosshair cursor.



- 2 In the *Method* area, select *Numerical*.

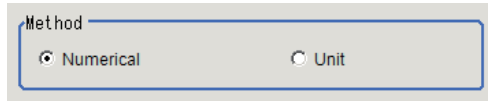

- 3** Click the position to be set as the reference.



Additional Information

Displaying the image enlarged makes this clicking easier.

For details, refer to *Appendix Basic Knowledge about Operations Using the Zoom Function in the Vision System FH/FHV Series User's Manual* (Cat. No. Z365).

- 4** Make fine adjustments using numeric value inputs or the arrow buttons as required.

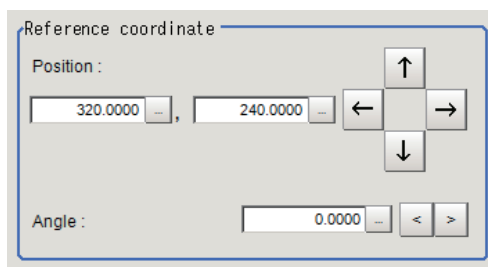

- 5** Set the reference angle with a numeric value.

- 6** To remeasure on the displayed image and set the reference, click **Measure ref.**.
To update the reference angle at the time of reference measurement, place a check at *Update the angle when measure ref.* .

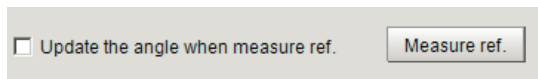

- 7** To use data before position compensation for the reference setting coordinates, place a check at *Use point coordinate before scroll.*

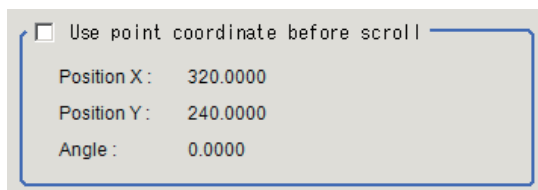

Precautions for Correct Use

If you check *Use point coordinate before scroll*, do not use the following processing items. Otherwise, correct search results cannot be obtained.

- Precise Calibration
- Calibration Data Reference

Referencing a Unit

Set a reference by referencing a detection point unit with registered X coordinate, Y coordinate and angle data.

- 1 In the Item tab area, click **Ref. setting**.
In the *Display* area, the current reference position will be displayed as the crosshair cursor.
- 2 In the *Method* area, select *Unit*.



- 3 In the *Unit* area, select a detection point unit in the scene.

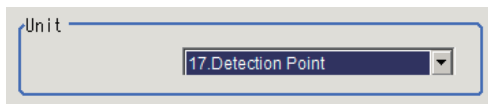

Performing the next measurement will display the reference.

2-1-6 Measurement Parameters (Search)

Specify the measurement conditions and the judgment conditions for the measurement results of Search.

- 1 In the Item tab area, click **Measurement**.
- 2 In the *Measurement condition* area, specify a value for each item.

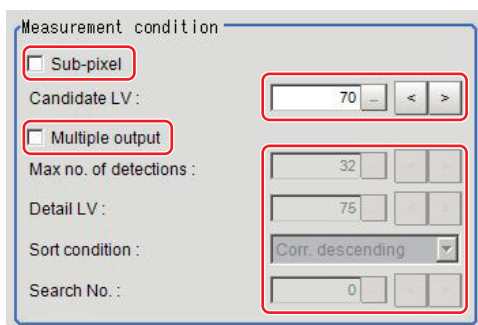

Setting item	Setting value [Factory default]	Description
Sub-pixel	<ul style="list-style-type: none"> • Checked • [Unchecked] 	When a check is placed at <i>sub-pixel</i> , the position information can be measured in units of sub-pixels. However, this requires more processing time.
Candidate LV	0 to 100 [70]	Specify the threshold value with which to detect candidate points in a rough search. Specify a smaller value when model search results are unreliable.

When executing a multi search:

Setting item	Setting value [Factory default]	Description
Multiple output	<ul style="list-style-type: none"> • Checked • [Unchecked] 	Select to execute a multi-search.
Max. no. of detections	1 to 128 [32]	This executing item is available when <i>Multi search</i> is executed. Specify the maximum number of detections. If it detects more objects than the <i>specified value</i> , these matches are sorted out to output up to the <i>specified value</i> from the top.
Detail LV	0 to 100 [75]	Specify the threshold value with which to detect candidate points in a detail search.
Sort condition	<ul style="list-style-type: none"> • Corr. ascending • [Corr. descending] • X coordinate ascending • X coordinate descending • Y coordinate ascending • Y coordinate descending 	Specify the conditions by which the search number is re-assigned. When sorting referencing the X and Y coordinates, the upper left is the origin.
Search No.	0 to 127 [0]	Specify which of the multiple detection results will be used as measured results.

- 3** When the setting has been changed, click **Measure** in the *Detail* area to verify whether measurements can be made correctly.

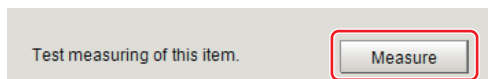

Additional Information

When the display settings for multiple points are overlapped, magnify the displayed image to check.

- 4** Set up the judgment condition.



Additional Information

The values beside each item are measurement results of the displayed image. Take these values into consideration to determine the upper and lower limit values.

Setting item	Setting value	Description
Count	0 to 128	Specify the number of detections that are judged to be OK.
Position X	-99,999.9999 to 99,999.9999	Specify the range of X-axis shifting that is judged to be OK.
Position Y	-99,999.9999 to 99,999.9999	Specify the range of Y-axis shifting that is judged to be OK.
Angle θ	-180 to 180	Specify the range of angles that are judged to be OK.

Setting item	Setting value	Description
Correlation	0 to 100	Specify the range of correlation values that are judged to be OK. However, when the correlation value of the measurement result is 0, the judgment result will be NG regardless of the lower limit setting.

2-1-7 Output Parameters (Search)

Specify how to treat the coordinates to be output to the external device as measurement results. This item can be changed if necessary. Normally, the factory default value will be used.



Precautions for Correct Use

After setting up the measurement parameters, changing the output parameters will cause measurement results to vary accordingly. If the output parameters have been changed, re-specify the measurement, too.

- 1 Click **Output parameter** in the Item tab area.
- 2 Specify each of the following items.

Setting item	Setting value [Factory default]	Description
Output coordinates	<ul style="list-style-type: none"> • [After scroll] • Before scroll 	As measurement results, select whether to output coordinate values to external devices before or after the position deflection correction is applied.
Calibration	<ul style="list-style-type: none"> • ON • [OFF] 	Select whether to reflect the calibration in the values output to the external device as measurement results. <ul style="list-style-type: none"> • ON: Output the coordinates converted into actual dimensions. • OFF: Output the camera coordinate values.
Reflect to overall judgment	<ul style="list-style-type: none"> • [ON] • OFF 	Enables choosing whether or not the judgement results of this processing unit is reflected in the scene overall judgment.



Additional Information

For output coordinates and calibration, refer to *Appendixes Measurement Mechanism Handling Coordinates* in the *Vision System FH/FHV Series User's Manual (Cat. No. Z365)*.

2-1-8 Key Points for Test Measurement and Adjustment (Search)

The following content is displayed in the *Detail result* area as text.



Precautions for Correct Use

Executing test measurements will also update the measurement results and the figures in the image.

Displayed item	Description
Judge	Judgment results 0: No judgment (unmeasured) 1: Judgment result OK -1: Judgment result NG -10: Error (image format mismatch) -11: Error (unregistered model) -12: Error (insufficient memory) -20: Error (other errors)
Count	Count
Correlation	Correlation
Position X	X coordinate of the position where the model is detected.
Position Y	Y coordinate of the position where the model is detected.
Angle θ	Angle of the position where the model is detected.

Key Points for Adjustment (Search)

Adjust the setting parameters referring to the following points.

● When searching other positions

Parameter to be adjusted	Remedy
Model parameter	Specify a larger value for the <i>Prec.</i>
	If the measurement results are unstable only when <i>Rotation</i> is selected, specify a smaller value for the <i>Skipping angle</i> .
	When <i>Rotation</i> is selected, if the model shape is complex, uncheck the <i>Smart mode</i> option.
	If the image has low contrast or blurred edges, set the <i>Search mode</i> to <i>CR</i> .
	If the model image consists of detailed figures, specify a larger value for <i>Stab</i> .
Measurement parameter	If the precision is low, place a check at <i>Sub-pixel</i> .
	If images that should be judged OK vary greatly, specify a smaller value for <i>Candidate LV</i> .

● When the judgement is NG (insufficient memory)

Parameter to be adjusted	Remedy
Region setting	Make the search region as small as possible.
Model parameter	Bring <i>Stab</i> . close to the factory default value.
	Bring the <i>Skipping angle</i> close to the factory default value.
	Specify a smaller value for <i>Prec.</i>

● When the processing speed is slow

Parameter to be adjusted	Remedy
Region setting	Make the search region as small as possible.
Model registration	Make the area to register as the model as small as possible.

Parameter to be adjusted	Remedy
Model parameter	If the model image is a simple figure or a large figure, specify a smaller value for <i>Stab</i> .
	If lowering stability does not speed up processing, it is likely that many candidates have been detected. Raise the <i>Candidate LV</i> in <i>Measurement</i> .
	When <i>Rotation</i> is selected and the model image is a simple figure, specify a larger value for the <i>Skipping angle</i> .
	When <i>Rotation</i> is selected and the model image is a simple figure, place a check at the <i>Smart mode</i> .
	If the position precision is high, specify a smaller value for <i>Prec</i> .
	If the rotation angle range is large, set the <i>Search mode</i> to <i>PT</i> .
Measurement parameter	If images that should be judged OK vary little, specify a larger value for <i>Candidate LV</i> .
	If the position precision is high, uncheck <i>Sub-pixel</i> .

2-1-9 Measurement Results for Which Output Is Possible (Search)

The following values can be output using processing items related to result output. It is also possible to reference measurement values from calculation expressions and other processing units.

Measurement items	Character string	Description
Judge	JG	Judgment results 0: No judgment (unmeasured) 1: Judgment result OK -1: Judgment result NG -10: Error (image format mismatch) -11: Error (unregistered model) -12: Error (insufficient memory) -20: Error (other errors)
Count	C	No. of models detected If none detected, 0
Correlation	CR	Correlation value with the model
Position X	X	X coordinate of the position where the model is detected.
Position Y	Y	Y coordinate of the position where the model is detected.
Angle θ	TH	Angle of the position where the model is detected.
Ref. position X	SX	X coordinate of the reference position of the registered model
Ref. position Y	SY	Y coordinate of the reference position of the registered model
Ref. angle	ST	Reference angle of registered model
Detection point RX	RX	X coordinate of detection point set when model was registered
Detection point RY	RY	Y coordinate of detection point set when model was registered
Correlation value N (N = 00 to 127)	CRN	Detected search N correlation value (N = 00 to 127)
Position XN (N = 00 to 127)	XN	Detected search N position X (N = 00 to 127)
Position YN (N = 00 to 127)	YN	Detected search N position Y (N = 00 to 127)

Measurement items	Character string	Description
Angle N (N = 00 to 127)	THN	Detected search N angle TH (N = 00 to 127)

2-1-10 External Reference Tables (Search)

No.	Data name	Data ident	Set/Get	Data range
0	Judge	judge	Get only	0: No judgment (unmeasured), 1: Judgment result OK, -1: Judgment result NG, -10: Error (image format mismatch), -11: Error (unregistered model), -12: Error (insufficient memory), -20: Error (other errors)
5	Correlation value	correlation	Get only	0 to 100
6	Measure X	positionX	Get only	-99,999.9999 to 99,999.9999
7	Measure Y	positionY	Get only	-99,999.9999 to 99,999.9999
8	Measure angel	angle	Get only	-180 to 180
9	Reference X	referenceX	Get only	-99,999.9999 to 99,999.9999
10	Reference Y	referenceY	Get only	-99,999.9999 to 99,999.9999
11	Reference angle	referenceAngle	Get only	-180 to 180
12	Detected coordinate X	detectionX	Get only	-99,999.9999 to 99,999.9999
13	Detected coordinate Y	detectionY	Get only	-99,999.9999 to 99,999.9999
14	Count	count	Get only	0 to 128
101	Output coordinates	outputCoordinate	Set/Get	0: After scroll, 1: Before scroll
102	Calibration	calibration	Set/Get	0: OFF, 1: ON
103	Reflect to overall judgement	overallJudge	Set/Get	0: ON, 1: OFF
120	Search mode	searchMode	Set/Get	0: Correlation, 1: Shape
121	With rotation	rotation	Set/Get	0: OFF, 1: ON
122	Upper limit of the rotation angle	endAngle	Set/Get	-180 to 180
123	Lower limit of the rotation angle	startAngle	Set/Get	-180 to 180
124	Skipping angle	angleSkip	Set/Get	1 to 30
125	Smart mode	smartMode	Set/Get	0: OFF, 1: ON
126	Stab.(CR)	stability	Set/Get	1 to 15
127	Prec.	accuracy	Set/Get	1 to 3
128	Stab.(PT)	searchSpeed	Set/Get	1 to 5
129	Reference X	referencePosX	Set/Get	0 to 99,999.9999
130	Reference Y	referencePosY	Set/Get	0 to 99,999.9999
132	Detection point X	detectionPosX	Set/Get	0 to 99,999.9999
133	Detection point Y	detectionPosY	Set/Get	0 to 99,999.9999
134	Sub-pixel	subPixel	Set/Get	0: OFF, 1: ON
135	Candidate Point Level	candidateLevel	Set/Get	0 to 100

No.	Data name	Data ident	Set/Get	Data range
136	Upper limit of measure X	upperX	Set/Get	-99,999.9999 to 99,999.9999
137	Lower limit of measure X	lowerX	Set/Get	-99,999.9999 to 99,999.9999
138	Upper limit of measure Y	upperY	Set/Get	-99,999.9999 to 99,999.9999
139	Lower limit of measure Y	lowerY	Set/Get	-99,999.9999 to 99,999.9999
140	Upper limit of the angle	upperAngle	Set/Get	-180 to 180
141	Lower limit of the angle	lowerAngle	Set/Get	-180 to 180
142	Upper limit of the corr.	upperCorrelation	Set/Get	0 to 100
143	Lower limit of the corr.	lowerCorrelation	Set/Get	0 to 100
144	Save registered model	savemdlimg	Set/Get	0: OFF, 1: ON
145	Candidate Point Level	thersDetail	Set/Get	0 to 100
146	Sort condition	sort	Set/Get	0: Corr. ascending, 1: Corr. descending 2: X ascending, 3: X descending, 4: Y ascending, 5: Y descending
147	Search No.	searchNo	Set/Get	0 to 127
148	Upper limit of count judgement	upperCount	Set/Get	0 to 128
149	Lower limit of count judgement	lowerCount	Set/Get	0 to 128
150	Multiple output	isMulti	Set/Get	0: OFF, 1: ON
151	Setting unit of reference coordinate	refUnitNo	Set/Get	-1 to 9,999
152	Setting type of reference coordinate	refSettingType	Set/Get	0: Numerical, 1: Unit
153	Update the reference angle	updateAngleFlg	Set/Get	0: Not update, 1: Update
154	Reference angle	referencePosAngle	Set/Get	-180 to 180
155	Setting unit of detection coordinate	detUnitNo	Set/Get	-1 to 9,999
156	Setting type of detection coordinate	detSettingType	Set/Get	0: Numerical, 1: Unit
157	Use point coordinate before scroll	beforeScrollRefMode	Set/Get	0: Not use, 1: Use
158	Reference X before scroll	beforeScrollRefPosX	Set/Get	-99,999.9999 to 99,999.9999
159	Reference Y before scroll	beforeScrollRefPosY	Set/Get	-99,999.9999 to 99,999.9999
160	Angle before scroll	beforeScrollRefAngle	Set/Get	-180 to 180
161	Max no. of detection	extractCount	Set/Get	1 to 128
5,100	Re-register	UpdateUnitModel	Set only	1: Execute

No.	Data name	Data ident	Set/Get	Data range
6,002	Format	cameraColor	Set/Get	1: Monochrome camera, 2: Color camera
30,000+N (N=0 to 127)	Correlation value	correlation000 to correlation127	Get only	0 to 100
40,000+N (N=0 to 127)	Measure X	positionX000 to positionX127	Get only	-99,999.9999 to 99,999.9999
50,000+N (N=0 to 127)	Measure Y	positionY000 to positionY127	Get only	-99,999.9999 to 99,999.9999
60,000+N (N=0 to 127)	Measure angle	angle000 to angle127	Get only	-180 to 180
91,000	figure0 Count	figArea0_count	Set/Get	1
91,001	figure0 Type	figArea0_fig0_type	Set/Get	8: Rectangle
91,002	figure0 mode	figArea0_fig0_mode	Set/Get	0: OR
91,014	figure0 Rectangle Upper left position X	figArea0_fig0_box_X0	Set/Get	-99,999 to 99,999
91,015	figure0 Rectangle Upper left position Y	figArea0_fig0_box_Y0	Set/Get	-99,999 to 99,999
91,016	figure0 Rectangle Lower right position X	figArea0_fig0_box_X1	Set/Get	-99,999 to 99,999
91,017	figure0 Rectangle Lower right position Y	figArea0_fig0_box_Y1	Set/Get	-99,999 to 99,999
91,099	figure0 Update	figArea0_update	Set only	1: Update

2-2 Search II

Register the feature sections of the measurement object as an image pattern (model), then find the most similar part to these models from the input images to detect the position.

The correlation value showing the degree of similarity, measurement object position, and inclination can be output.

Since the best model is created according to the size and rotation of a measurement object, a model that "Search" cannot detect can be also stably detected.

Used in the Following Case

When identifying the shape of measurement objects (for detecting defects or foreign matter):

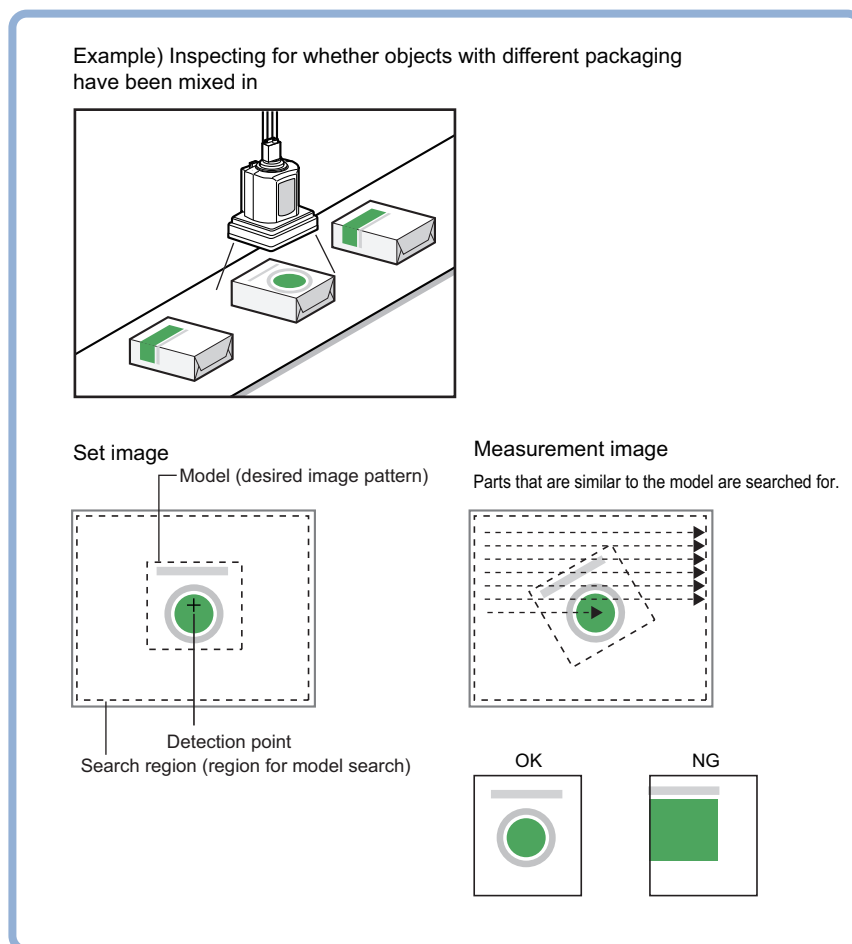

Precautions for Correct Use

Processing is different for color images and monochrome images. When the camera type used in the previous setup was changed to color or monochrome type, perform the settings again.



Additional Information

Search processing basic concepts

For details, refer to *Appendixes Measurement Mechanism Search Processing Mechanism in the Vision System FH/FHV Series User's Manual (Cat. No. Z365)*.

2-2-1 Settings Flow (Search II)

To set Search II, follow the steps below.

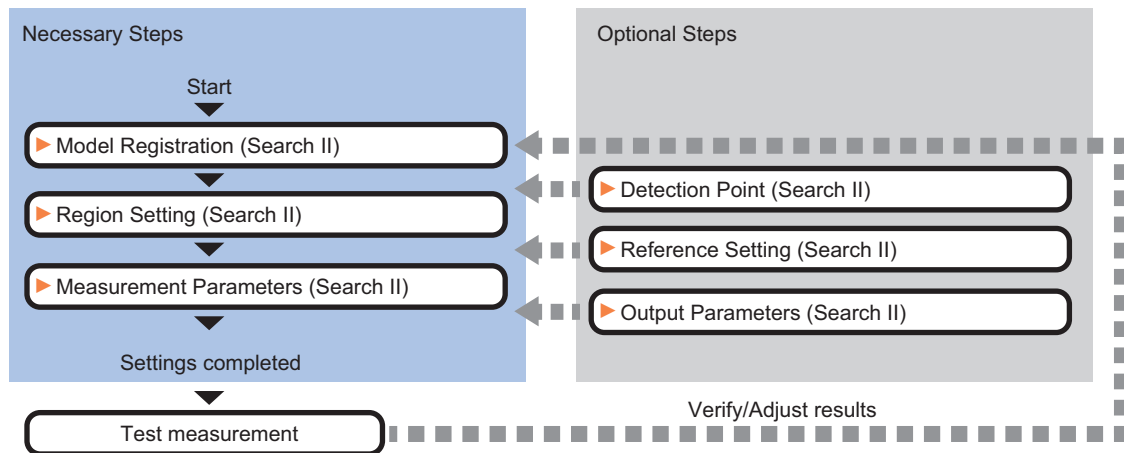

List of Search II Items

Item	Description
Model	This item registers the pattern characteristic of the measurement image as a model. Model parameter values can be changed as needed to address unstable measurement results or to increase the processing speed. Normally, the factory default value will be used. <i>2-2-2 Model Registration (Search II) on page 2-26</i>
Region setting	Sets the measurement area. It is possible to target the entire screen, but restricting the range can shorten the processing time. <i>2-2-3 Region Setting (Search II) on page 2-29</i>
Detection point	This item can be changed as necessary. Specify a position in the model that should be used as the detection coordinates during measurement. Usually, the central position of the set model is registered as the detection coordinates. <i>2-2-4 Detection Point (Search II) on page 2-29</i>
Ref. setting	This item can be changed as necessary. Specify the reference position within the camera's field of view. <i>2-2-5 Reference Setting (Search II) on page 2-30</i>
Measurement parameter	Sets processing conditions for measurement and judgment conditions for measurement results. Specify the criteria to judge the measurement result if the X and Y coordinates and the correlation with the model are OK. <i>2-2-6 Measurement Parameters (Search II) on page 2-31</i>
Output parameter	This item can be changed as necessary. Normally, the factory default value will be used. Use the output parameter to specify how to handle the coordinates. <i>2-2-7 Output Parameters (Search II) on page 2-33</i>

2-2-2 Model Registration (Search II)

Register the parts to measure as the model.

The position at the time of registration is also registered in the model information. Place the measurement object in the correct position when registering a model.



Additional Information

When a model is registered, the central coordinates of the model are registered as the detection point. A detection point is a point output as a measurement value. If multiple figures are combined, the central coordinates of the circumscribed rectangle are registered.

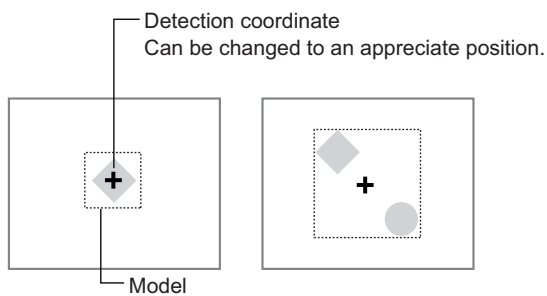

Additional Information

If the model registration range or image is large, the model registration process may take several minutes.

- 1** In the Item tab area, click **Model**.
When setting a new model, you do not have to click **Model**.
- 2** Use the drawing tools to specify the model registration range.
- 3** To save the entire image used for model registration, place a check at the *Save reg. model* option.

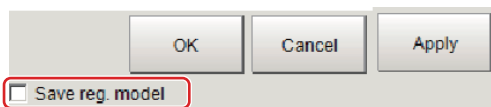

Additional Information

If you save the registered model image, you can re-register the model with the same image after model parameters are adjusted. Note that the scene data size increases when a registered model image is saved.

- 4** Click **OK** in the *Figure setting* area.
 - **OK**: Changes the settings and returns to the previous menu.
 - **Cancel**: Changes are discarded. Returns to the previous menu.
 - **Apply**: Updates the settings without leaving edit window.

Changing Model Parameters

Model parameter values can be changed as needed to address unstable measurement results or to increase the processing speed. Normally, the factory default value will be used. After changing a setting, re-register the model.

- 1 Set each item for the registering model in the *Model parameter* area.

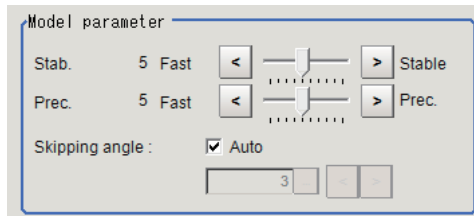

Setting item	Setting value [Factory default]	Description
Stab.	1 to 10 [5]	Specify which is to have priority, measurement stability or speed. If lowering stability does not speed up processing, it is likely that many candidates have been detected. In this case, specify a larger value for <i>Candidate LV</i> or <i>Stab.</i> .
Prec.	1 to 10 [5]	Specify which is to have priority, measurement positional precision or speed.
Skipping angle Auto	<ul style="list-style-type: none"> • [Checked] • Unchecked 	Place a check when setting the <i>skipping angle</i> automatically. The <i>Skipping angle</i> is determined according to the aspect ratio of the model figure when registering a model with a check. When the search result is not stable with <i>Auto</i> , uncheck it and then specify the <i>Skipping angle</i> .
Skipping angle	1 to 30 [3]	Specify how many degrees the model created rotates each time. Although a smaller skipping angle increases stability, the processing time becomes longer.

Displaying/Re-Registering/Deleting a Model

The buttons described in the following table are available when a model registration image is saved. You can use these buttons to reconfirm images used for model registration, or re-registering the model after adjusting detail settings.

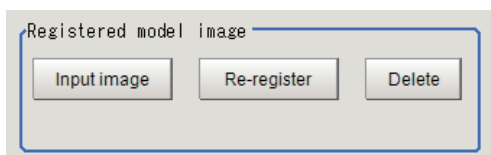

Setting item	Setting value	Description
Disp model/Input image	-	The model image display and input image display are switched.

Setting item	Setting value	Description
Re-register	-	Re-registers a model using the model registration image. When model parameters are changed, you can display the model registration image and re-register. This button is available when the model registration image is displayed.
Delete	-	Deletes a model.

2-2-3 Region Setting (Search II)

Use a rectangle to specify the area where the model is searched.

Instead of measuring the entire input image, narrowing the measurement area shortens the processing time.

- 1** In the Item tab area, click **Region setting**.
- 2** Click **Edit**.
The *Figure Setting* area is displayed.
- 3** Specify the area in which to search for the model.
The rectangle covering the entire screen is set. Adjust the size and position of the rectangle.
- 4** Click **OK** in the *Figure setting* area.
 - **OK**: Changes the settings and returns to the previous menu.
 - **Cancel**: Changes are discarded. Returns to the previous menu.
 - **Apply**: Updates the settings without leaving edit window.

2-2-4 Detection Point (Search II)

Specify a position in the model that should be used as the detection coordinates during measurement. Usually, the central position of the set model is registered as the detection point. This function is used to change to any desired position.



Additional Information

After changing the detection point coordinates to another position, re-registering the model will change it back to the center coordinates of the model.

- 1** In the Item tab area, click **Detection point**.
In the *Display* area, the current detection point is displayed with a crosshair cursor.



- 2** Click the position to be set as the detection point.



Additional Information

Displaying the image enlarged makes this clicking easier.

For details, refer to *Appendixes Basic Knowledge about Operations Using the Zoom Function in the Vision System FH/FHV Series User's Manual (Cat. No. Z365)*.

- 3** Make fine adjustments using numeric value inputs or the arrow buttons as required.

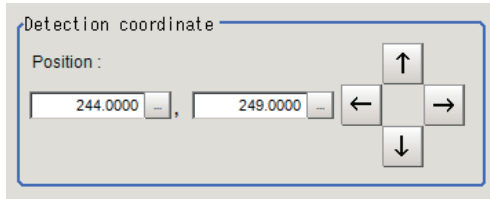

2-2-5 Reference Setting (Search II)

When the model is set, this position is automatically set at the same time as the reference position. This item can be set to change the reference position to any desired position. This is handy for measuring the position deviation from a certain position.

- 1 In the Item tab area, click **Ref. setting**.
In the *Display* area, the current reference position will be displayed as the crosshair cursor.



- 2 Click the position to be set as the reference.



Additional Information

Displaying the image enlarged makes this clicking easier.
For details, refer to *Appendixes Basic Knowledge about Operations Using the Zoom Function in the Vision System FH/FHV Series User's Manual* (Cat. No. Z365).

- 3 Make fine adjustments using numeric value inputs or the arrow buttons as required.

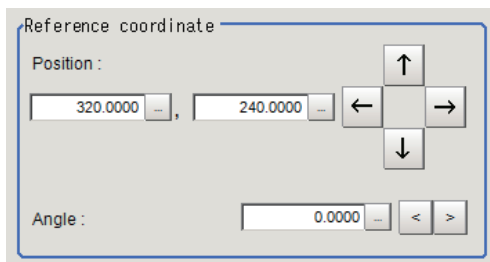

- 4 Set the reference angle with a numeric value.
- 5 To remeasure on the displayed image and set the reference, click **Measure ref.**.
To update the reference angle at the time of reference measurement, place a check at *Update the angle when measure ref.*

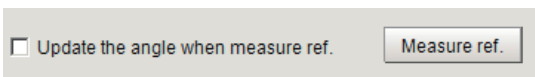

- 6** To use data before position compensation for the reference setting coordinates, place a check at *Use point coordinate before scroll*.

Use point coordinate before scroll

Position X: 320.0000

Position Y: 240.0000

Angle: 0.0000



Precautions for Correct Use

If you check *Use point coordinate before scroll*, do not use the following processing items. Otherwise, correct search results cannot be obtained.

- Precise Calibration
- Calibration Data Reference

2-2-6 Measurement Parameters (Search II)

Specify the measurement conditions and the judgment conditions for the measurement results of Search II.

- 1** In the Item tab area, click **Measurement**.
- 2** In the *Measurement condition* area, specify a value for each item.

Measurement condition

Candidate LV: 60

Rotation

Angle range: -180 - 180

Multiple output

Max no. of detections: 32

Sort condition: Corr. descending

Search No.: 0

Setting item	Setting value [Factory default]	Description
Candidate LV	0 to 100 [60]	Specify the threshold value with which to detect candidate points in a rough search. Specify a smaller value when model search results are unreliable.
Rotation	<ul style="list-style-type: none"> • Checked • [Unchecked] 	Place a check to <i>Rotation</i> when the measurement object rotates.
Angle range	-180 to 180 [-180] to [180]	Specify the rotational angle range in a search. The clockwise is the positive direction.
Multiple output	<ul style="list-style-type: none"> • Checked • [Unchecked] 	Select to execute a multi-search.

Setting item	Setting value [Factory default]	Description
Max. no. of detections	1 to 128 [32]	This executing item is available when <i>Multi search</i> is executed. Specify the maximum number of detections. If it detects more objects than the <i>specified value</i> , these matches are sorted out to output up to the <i>specified value</i> from the top.
Sort condition	<ul style="list-style-type: none"> • Corr. ascending • [Corr. descending] • X coordinate ascending • X coordinate descending • Y coordinate ascending • Y coordinate descending 	Specify the conditions by which the search number is re-assigned. When sorting referencing the X and Y coordinates, the upper left is the origin.
Search No.	0 to 127 [0]	Specify which of the multiple detection results will be used as measured results.

- 3** When the setting has been changed, click **Measure** in the *Detail* area to verify whether measurements can be made correctly.

Test measuring of this item.

Measure



Additional Information

When the display settings for multiple points are overlapped, magnify the displayed image to check.

- 4** Set up the judgment condition.



Additional Information

The values beside each item are measurement results of the displayed image. Take these values into consideration to determine the upper and lower limit values.

Setting item	Setting value	Description
Count	0 to 128	Specify the number of detections that are judged to be OK.
Position X	-99,999.9999 to 99,999.9999	Specify the range of X-axis shifting that is judged to be OK.
Position Y	-99,999.9999 to 99,999.9999	Specify the range of Y-axis shifting that is judged to be OK.
Angle θ	-180 to 180	Specify the range of angles that are judged to be OK.
Correlation	0 to 100	Specify the range of correlation values that are judged to be OK.

2-2-7 Output Parameters (Search II)

Specify how to treat the coordinates to be output to the external device as measurement results. This item can be changed if necessary. Normally, the factory default value will be used.



Precautions for Correct Use

After setting up the measurement parameters, changing the output parameters will cause measurement results to vary accordingly. If the output parameters have been changed, re-specify the measurement, too.

- 1 Click **Output parameter** in the Item tab area.
- 2 Specify each of the following items.

Setting item	Setting value [Factory default]	Description
Output coordinates	<ul style="list-style-type: none"> • [After scroll] • Before scroll 	As measurement results, select whether to output coordinate values to external devices before or after the position deflection correction is applied.
Calibration	<ul style="list-style-type: none"> • ON • [OFF] 	Select whether to reflect the calibration in the values output to the external device as measurement results. <ul style="list-style-type: none"> • ON: Output the coordinates converted into actual dimensions. • OFF: Output the camera coordinate values.
Reflect to overall judgment	<ul style="list-style-type: none"> • [ON] • OFF 	Enables choosing whether or not the judgement results of this processing unit is reflected in the scene overall judgment.



Additional Information

For output coordinates and calibration, refer to *Appendixes Measurement Mechanism Handling Coordinates* in the *Vision System FH/FHV Series User's Manual (Cat. No. Z365)*.

2-2-8 Key Points for Test Measurement and Adjustment (Search II)

The following content is displayed in the *Detail result* area as text.



Precautions for Correct Use

Executing test measurements will also update the measurement results and the figures in the image.

Displayed item	Description
Judge	Judgment results 0: No judgment (unmeasured) 1: Judgment result OK -1: Judgment result NG -10: Error (image format mismatch) -11: Error (unregistered model) -12: Error (insufficient memory) -20: Error (other errors)

Displayed item	Description
Count	Count
Correlation	Correlation
Position X	X coordinate of the position where the model is detected.
Position Y	Y coordinate of the position where the model is detected.
Angle θ	Angle of the position where the model is detected.

Key Points for Adjustment (Search II)

Adjust the setting parameters referring to the following points.

● When searching other positions

Parameter to be adjusted	Remedy
Model parameter	Specify a larger value for the <i>Prec.</i>
	Specify a larger value for <i>Stab.</i>
	If the measurement results are unstable only when <i>Rotation</i> is selected, specify a smaller value for the <i>Skipping angle</i> .
Measurement parameter	If images that should be judged OK vary greatly, specify a smaller value for <i>Candidate LV</i> .
	If the measurement results are unstable only when <i>Rotation</i> is selected, specify a smaller value for the <i>Angle range</i> .

● When the processing speed is slow

Parameter to be adjusted	Remedy
Region setting	Make the search region as small as possible.
Model registration	Make the area to register as the model as small as possible.
Model parameter	Specify a value for the <i>Stab.</i> as small as possible.
	Specify a value for the <i>Prec.</i> as small as possible.
	Uncheck the <i>Skipping angle Auto</i> and specify a value for the <i>Skipping angle</i> as large as possible.
Measurement parameter	Specify a value for <i>Candidate LV</i> as large as possible.
	Specify a value for <i>Rotation range</i> as small as possible.

● When the model registration fails

Parameter to be adjusted	Remedy
Model registration	Make the area to register as the model as small as possible.
Model parameter	Specify a value for the <i>Stab.</i> as small as possible.
	Specify a value for the <i>Prec.</i> as small as possible.
	Uncheck the <i>Skipping angle Auto</i> and specify a value for the <i>Skipping angle</i> as large as possible.
	Uncheck the <i>Save reg. model</i> .

● When the judgment is NG (insufficient memory)

Parameter to be adjusted	Remedy
Region setting	Make the search region as small as possible.
Model registration	Make the area to register as the model as small as possible.
Model parameter	Specify a value for the <i>Stab.</i> as small as possible.
	Specify a value for the <i>Prec.</i> as small as possible.
	Uncheck the <i>Skipping angle Auto</i> and specify a value for the <i>Skipping angle</i> as large as possible.
Measurement parameter	Specify a value for <i>Candidate LV</i> as large as possible.

2-2-9 Measurement Results for Which Output Is Possible (Search II)

The following values can be output using processing items related to result output. It is also possible to reference measurement values from calculation expressions and other processing units.

Measurement items	Character string	Description
Judge	JG	Judgment results 0: No judgment (unmeasured) 1: Judgment result OK -1: Judgment result NG -10: Error (image format mismatch) -11: Error (unregistered model) -12: Error (insufficient memory) -20: Error (other errors)
Count	C	No. of models detected If none detected, 0
Correlation	CR	Correlation value with the model
Position X	X	X coordinate of the position where the model is detected.
Position Y	Y	Y coordinate of the position where the model is detected.
Angle θ	TH	Angle of the position where the model is detected.
Ref. position X	SX	X coordinate of the reference position of the registered model
Ref. position Y	SY	Y coordinate of the reference position of the registered model
Ref. angle	ST	Reference angle of registered model
Detection point RX	RX	X coordinate of detection point set when model was registered
Detection point RY	RY	Y coordinate of detection point set when model was registered
Correlation value N (N = 00 to 127)	CRN	Detected search N correlation value (N = 00 to 127)
Position XN (N = 00 to 127)	XN	Detected search N position X (N = 00 to 127)
Position YN (N = 00 to 127)	YN	Detected search N position Y (N = 00 to 127)
Angle N (N = 00 to 127)	THN	Detected search N angle TH (N = 00 to 127)

2-2-10 External Reference Tables (Search II)

No.	Data name	Data ident	Set/Get	Data range
0	Judge	judge	Get only	0: No judgment (unmeasured), 1: Judgment result OK, -1: Judgment result NG, -10: Error (image format mismatch), -11: Error (unregistered model), -12: Error (insufficient memory), -20: Error (other errors)
5	Correlation value	correlation	Get only	0 to 100
6	Position X	positionX	Get only	-99,999.9999 to 99,999.9999
7	Position Y	positionY	Get only	-99,999.9999 to 99,999.9999
8	Angle	angle	Get only	-180 to 180
9	Reference positionX	referenceX	Get only	-99,999.9999 to 99,999.9999
10	Reference positionY	referenceY	Get only	-99,999.9999 to 99,999.9999
11	Reference angle	referenceAngle	Get only	-180 to 180
12	Detected coordinate X	detectionX	Get only	-99,999.9999 to 99,999.9999
13	Detected coordinate Y	detectionY	Get only	-99,999.9999 to 99,999.9999
14	Count	count	Get only	0 to 128
100	Output Coordinates	outputCoordinate	Set/Get	0: After scroll, 1: Before scroll
101	Calibration	calibration	Set/Get	0: OFF, 1: ON
102	Reflect to overall judgement	overallJudge	Set/Get	0: ON, 1: OFF
120	Prec.	accuracy	Set/Get	1 to 10
121	Stability	stability	Set/Get	1 to 10
122	Skipping angle mode	rotationStepSetting-Mode	Set/Get	0: Auto, 1: Manual
123	Skipping angle	rotationStep	Set/Get	1 to 30
131	Detection point X	detectionPosX	Set/Get	0 to 99,999.9999
132	Detection point Y	detectionPosY	Set/Get	0 to 99,999.9999
141	Reference positionX	referencePosX	Set/Get	0 to 99,999.9999
142	Reference positionY	referencePosY	Set/Get	0 to 99,999.9999
143	Update the reference angle	updateAngleFlg	Set/Get	0: Not update, 1: Update
144	Reference angle	referencePosAngle	Set/Get	-180 to 180
145	Use point coordinate before scroll(Central reference setting)	beforeScrollRefMode	Set/Get	0: Not use, 1: Use
146	Position X before scroll	beforeScrollRefPosX	Set/Get	-99,999.9999 to 99,999.9999
147	Position Y before scroll	beforeScrollRefPosY	Set/Get	-99,999.9999 to 99,999.9999
148	Angle before scroll	beforeScrollRefAngle	Set/Get	-180 to 180
150	With rotation	rotation	Set/Get	0: OFF, 1: ON
151	Lower limit of the rotation angle	startAngle	Set/Get	-180 to 180

No.	Data name	Data ident	Set/Get	Data range
152	Upper limit of the rotation angle	endAngle	Set/Get	-180 to 180
153	Candidate Point Level	candidateLevel	Set/Get	0 to 100
154	Multiple output	multiExtractCount	Set/Get	0: No, 1: Yes
155	Max no. of detection	maxExtractCount	Set/Get	1 to 128
156	Sort cond.	sortType	Set/Get	0: Corr. ascending, 1: Corr. descending, 2: X ascending, 3: X descending, 4: Y ascending, 5: Y descending
157	Search No.	searchNo	Set/Get	0 to 127
200	Lower limit of count judgement	lowerCount	Set/Get	0 to 128
201	Upper limit of count judgement	upperCount	Set/Get	0 to 128
202	Lower limit of measure X	lowerX	Set/Get	-99,999.9999 to 99,999.9999
203	Upper limit of measure X	upperX	Set/Get	-99,999.9999 to 99,999.9999
204	Lower limit of measure Y	lowerY	Set/Get	-99,999.9999 to 99,999.9999
205	Upper limit of measure Y	upperY	Set/Get	-99,999.9999 to 99,999.9999
206	Lower limit of the angle	lowerAngle	Set/Get	-180 to 180
207	Upper limit of the angle	upperAngle	Set/Get	-180 to 180
208	Lower limit of the corr.	lowerCorrelation	Set/Get	0 to 100
209	Upper limit of the corr.	upperCorrelation	Set/Get	0 to 100
300	Save registered model	saveModellImageEnable	Set/Get	0:No 1:Yes
30,000+N (N=0 to 127)	Correlation value	correlation000 to correlation127	Get only	0 to 100
40,000+N (N=0 to 127)	Measure X	positionX000 to positionX127	Get only	-99,999.9999 to 99,999.9999
50,000+N (N=0 to 127)	Measure Y	positionY000 to positionY127	Get only	-99,999.9999 to 99,999.9999
60,000+N (N=0 to 127)	Angle	angle000 to angle127	Get only	-180 to 180
91,000	figure0 Count	figArea0_count	Set/Get	1
91,001	figure0 Type	figArea0_fig0_type	Set/Get	8: Rectangle
91,002	figure0 mode	figArea0_fig0_mode	Set/Get	0:OR
91,014	figure0 Rectangle Upper left position X	figArea0_fig0_box_X0	Set/Get	-99,999 to 99,999
91,015	figure0 Rectangle Upper left position Y	figArea0_fig0_box_Y0	Set/Get	-99,999 to 99,999

No.	Data name	Data ident	Set/Get	Data range
91,016	figure0 Rectangle Lower right position X	figAr- ea0_fig0_box_X1	Set/Get	-99,999 to 99,999
91,017	figure0 Rectangle Lower right position Y	figAr- ea0_fig0_box_Y1	Set/Get	-99,999 to 99,999
91,099	figure0 Update	figArea0_update	Set only	1: Update

2-3 Flexible Search

In Flexible Search, multiple measurement object features (models) are registered beforehand. Parts from input images that most resemble the multiple models are searched for, and correlation (similarity) and position are determined.

Used in the Following Case

To treat models with only slight variations as the same and prevent excessive filtering out.

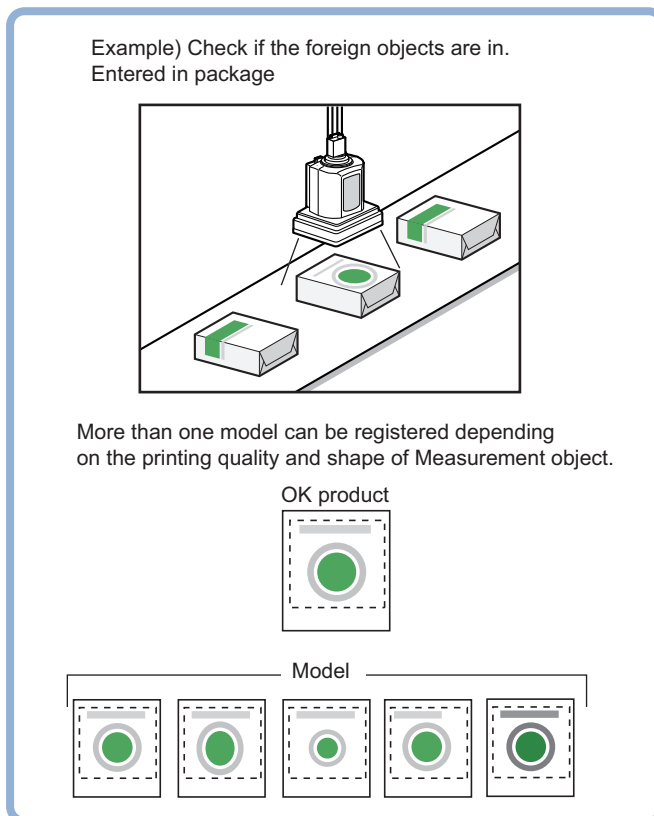

Precautions for Correct Use

Processing is different for color images and monochrome images. When the camera type used in the previous setup was changed to color or monochrome type, perform the settings again.



Additional Information

Search processing basic concepts

For details, refer to *Appendixes Measurement Mechanism Search Processing Mechanism* in the *Vision System FH/FHV Series User's Manual (Cat. No. Z365)*.

2-3-1 Settings Flow (Flexible Search)

To set Flexible Search, follow the steps below.

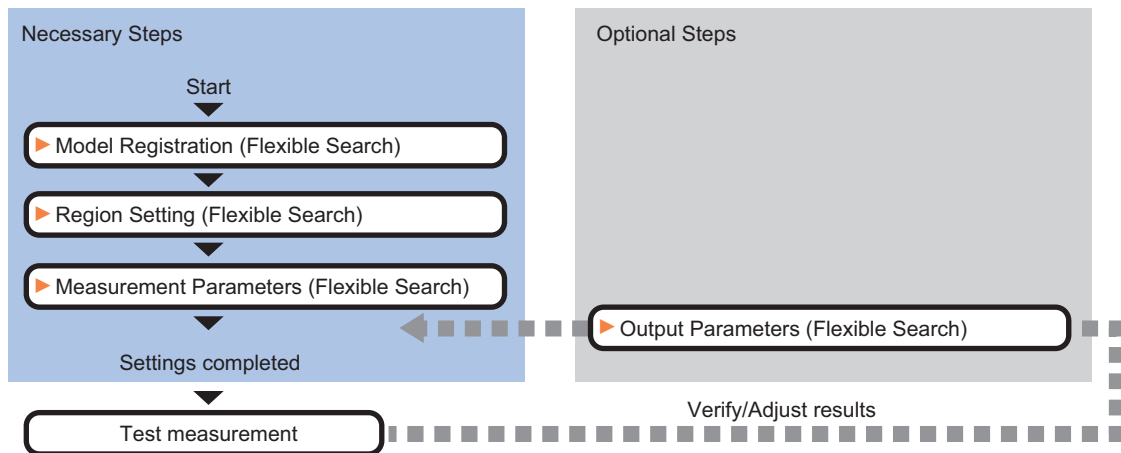

List of Flexible Search Items

Item	Description
Model	This item registers the pattern characteristic of the measurement image as a model. Model parameter values can be changed as needed to address unstable measurement results or to increase the processing speed. Normally, the factory default value will be used. <i>2-3-2 Model Registration (Flexible Search) on page 2-41</i>
Region setting	Sets the measurement area. It is possible to target the entire screen, but restricting the range can shorten the processing time. <i>2-3-3 Region Setting (Flexible Search) on page 2-43</i>
Measurement parameter	Sets processing conditions for measurement and judgment conditions for measurement results. Specify the criteria to judge the measurement result if the X and Y coordinates and the correlation with the model are OK. <i>2-3-4 Measurement Parameters (Flexible Search) on page 2-44</i>
Output parameter	This item can be changed as necessary. Normally, the factory default value will be used. Use the output parameter to specify how to handle the coordinates. <i>2-3-5 Output Parameters (Flexible Search) on page 2-45</i>

2-3-2 Model Registration (Flexible Search)

Register the parts to measure as the model.

The position at the time of registration is also registered in the model information. Place the measurement object in the correct position when registering a model.

A total of 5 models, 0 through 4, can be registered, with no restriction on the size.

If a model has different printing qualities and shapes, more than one models should be registered.



Additional Information

When a model is registered, the central coordinates of the model are registered as the detection point. A detection point is a point output as a measurement value. If multiple figures are combined, the central coordinates of the circumscribed rectangle are registered.

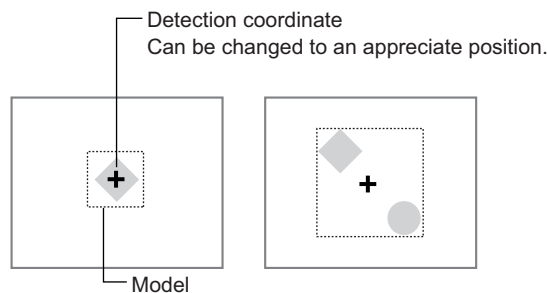

- 1 In the Item tab area, click **Model register**.
- 2 In the *Setting model* area, select a model and click **New**.

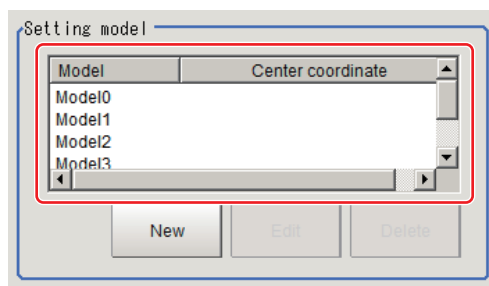

- 3 Use the drawing tools to specify the model registration range.
- 4 Click **OK** in the *Figure setting* area.
 - **OK**: Changes the settings and returns to the previous menu.
 - **Cancel**: Changes are discarded. Returns to the previous menu.
 - **Apply**: Updates the settings without leaving edit window.

When a model is registered, the central coordinates (X, Y) of the model are registered as the detection point.

The registered model image is displayed in the *Image Display* area.

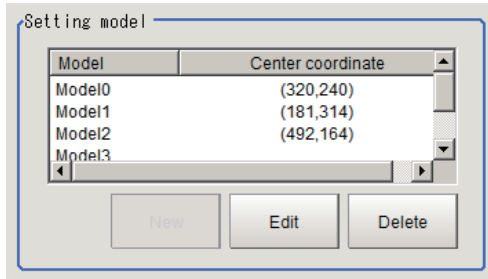

- 5** To register two or more models, repeat step 2 to 4.

Changing Model Parameters

Model parameter values can be changed as needed to address unstable measurement results or to increase the processing speed. Normally, the factory default value will be used.

After changing a setting, re-register the model.

- 1** In the *Model parameter* area, select the *Search mode*, then specify a value for each item for that mode.

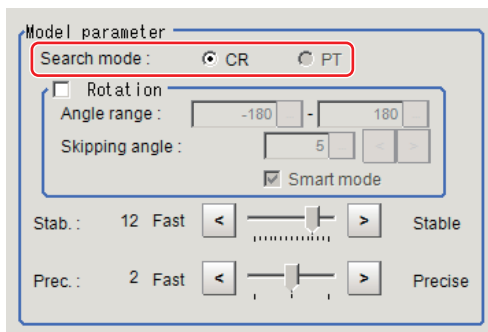

Setting item	Setting value [Factory default]	Description
Search mode	<ul style="list-style-type: none"> [CR] PT 	<ul style="list-style-type: none"> CR: Search for normalizing the brightness. This method can provide stable measurement when there is fluctuation in the overall brightness and when the image has low contrast. PT: Measures the degree of matching with the profile. This method can measure at higher speed when the rotation angle has a wide range. It is available only when a 0.3 megapixel color camera is connected.

- When CR is selected:

Setting item	Setting value [Factory default]	Description
Rotation	<ul style="list-style-type: none"> • Checked • [Unchecked] 	When the measurement object is rotating, place a check at <i>Rotation</i> and specify how many degrees the model created rotates each time and through what range of angles. A smaller skipping angle increases stability, but slows down the processing. The forward direction is clockwise.
Angle range	-180 to 180 [-180] to [180]	
Skipping angle	1 to 30 [5]	
Smart mode	<ul style="list-style-type: none"> • [Checked] • Unchecked 	Checking the <i>Smart mode</i> option enables a high-speed rotation search. However, the stability may be lowered when the model shape aspect ratio is large or when the NOT mask is used.
Stab.	1 to 15 The default value depend on the connected camera. [9] or [12]	Specify which is to have priority, measurement stability or speed. If lowering stability does not speed up processing, it is likely that many candidates have been detected. In this case, specify a larger value for <i>Candidate LV</i> or <i>Stab.</i> .
Prec.	1 to 3 [2]	Specify which is to have priority, measurement positional precision or speed.

- When PT is selected:

Setting item	Setting value [Factory default]	Description
Angle range	-180 to 180 [-180] to [180]	This item specifies the rotation angle range for searching. The normal direction is clockwise.
Stab.	1 to 5 [3]	If lowering stability does not speed up processing, it is likely that many candidates have been detected. In this case, specify a larger value for <i>Candidate LV</i> or <i>Stab.</i> .

2-3-3 Region Setting (Flexible Search)

Use a rectangle to specify the area where the model is searched.

Instead of measuring the entire input image, narrowing the measurement area shortens the processing time.

- 1** In the Item tab area, click **Region setting**.
- 2** Click **Edit**.
The *Figure Setting* area is displayed.
- 3** Specify the area in which to search for the model.
The rectangle covering the entire screen is set. Adjust the size and position of the rectangle.
- 4** Click **OK** in the *Figure setting* area.
 - **OK**: Changes the settings and returns to the previous menu.
 - **Cancel**: Changes are discarded. Returns to the previous menu.
 - **Apply**: Updates the settings without leaving edit window.

2-3-4 Measurement Parameters (Flexible Search)

Specify the measurement conditions and the judgment conditions for the measurement results of Search.

- 1 In the Item tab area, click **Measurement**.
- 2 In the *Measurement condition* area, specify a value for each item.

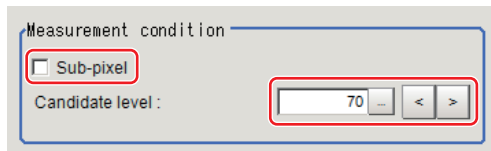

Setting item	Setting value [Factory default]	Description
Sub-pixel	<ul style="list-style-type: none"> • Checked • [Unchecked] 	When a check is placed at <i>sub-pixel</i> , the position information can be measured in units of sub-pixels. However, this requires more processing time.
Candidate LV	0 to 100 [70]	Specify the threshold value with which to detect candidate points in a rough search. Specify a smaller value when model search results are unreliable.

- 3 When the setting has been changed, click **Measure** in the *Detail* area to verify whether measurements can be made correctly.

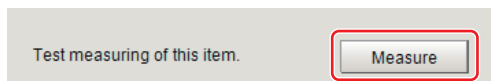

Additional Information

When the display settings for multiple points are overlapped, magnify the displayed image to check.

- 4 Set up the judgment condition.



Additional Information

The values beside each item are measurement results of the displayed image. Take these values into consideration to determine the upper and lower limit values.

Setting item	Setting value	Description
Position X	-99,999.9999 to 99,999.9999	Specify the range of X-axis shifting that is judged to be OK.
Position Y	-99,999.9999 to 99,999.9999	Specify the range of Y-axis shifting that is judged to be OK.
Angle θ	-180 to 180	Specify the range of angles that are judged to be OK.
Correlation	0 to 100	Specify the range of correlation values that are judged to be OK. However, when the correlation value of the measurement result is 0, the judgment result will be NG regardless of the lower limit setting.

2-3-5 Output Parameters (Flexible Search)

Specify how to treat the coordinates to be output to the external device as measurement results. This item can be changed if necessary. Normally, the factory default value will be used.



Precautions for Correct Use

After setting up the measurement parameters, changing the output parameters will cause measurement results to vary accordingly. If the output parameters have been changed, re-specify the measurement, too.

- 1 Click **Output parameter** in the Item tab area.
- 2 Specify each of the following items.

Setting item	Setting value [Factory default]	Description
Output coordinates	<ul style="list-style-type: none"> • [After scroll] • Before scroll 	As measurement results, select whether to output coordinate values to external devices before or after the position deflection correction is applied.
Calibration	<ul style="list-style-type: none"> • ON • [OFF] 	Select whether to reflect the calibration in the values output to the external device as measurement results. <ul style="list-style-type: none"> • ON: Output the coordinates converted into actual dimensions. • OFF: Output the camera coordinate values.
Reflect to overall judgment	<ul style="list-style-type: none"> • [ON] • OFF 	Enables choosing whether or not the judgement results of this processing unit is reflected in the scene overall judgment.



Additional Information

For output coordinates and calibration, refer to *Appendixes Measurement Mechanism Handling Coordinates* in the *Vision System FH/FHV Series User's Manual (Cat. No. Z365)*.

2-3-6 Key Points for Test Measurement and Adjustment (Flexible Search)

The following content is displayed in the *Detail result* area as text.

Displayed item	Description
Judge	Judgment results 0: No judgment (unmeasured) 1: Judgment result OK -1: Judgment result NG -10: Error (image format mismatch) -11: Error (unregistered model) -12: Error (insufficient memory) -20: Error (other errors)
Model No.	Model No. of the highest correlation value
Correlation	Correlation value with the model
Position X	X coordinate of the position where the model is detected.
Position Y	Y coordinate of the position where the model is detected.
Angle θ	Angle of the position where the model is detected.



Additional Information

If the model is an ellipse, its circumscribing rectangle is displayed as the search result of the model.

Key Points for Adjustment (Flexible Search)

Adjust the setting parameters referring to the following points.

● When Searching other positions

Parameter to be adjusted	Remedy
Model parameter	Specify a larger value for the <i>Prec.</i>
	If the measurement results are unstable only when <i>Rotation</i> is selected, specify a smaller value for the <i>Skipping angle</i> .
	When <i>Rotation</i> is selected, if the model shape is complex, uncheck the <i>Smart mode</i> option.
	If the image has low contrast or blurred edges, set the <i>Search mode</i> to <i>CR</i> .
	If the model image consists of detailed figures, specify a larger value for <i>Stab</i> .
Measurement parameter	If the precision is low, place a check at <i>Sub-pixel</i> .
	If images that should be judged OK vary greatly, specify a smaller value for <i>Candidate LV</i> .

● When the judgement is NG (insufficient memory)

Parameter to be adjusted	Remedy
Region setting	Make the search region as small as possible.

Parameter to be adjusted	Remedy
Model parameter	Bring <i>Stab.</i> close to the factory default value.
	Bring the <i>Skipping angle</i> close to the factory default value.
	Specify a smaller value for <i>Prec.</i>

● When the processing speed is slow

Parameter to be adjusted	Remedy
Region setting	Make the search region as small as possible.
Model registration	Make the area to register as the model as small as possible.
Model parameter	If the model image is a simple figure or a large figure, specify a smaller value for <i>Stab.</i>
	If lowering stability does not speed up processing, it is likely that many candidates have been detected. Raise the <i>Candidate LV</i> in <i>Measurement</i> .
	When <i>Rotation</i> is selected and the model image is a simple figure, specify a larger value for the <i>Skipping angle</i> .
	When <i>Rotation</i> is selected and the model image is a simple figure, place a check at the <i>Smart mode</i> .
	If the position precision is high, specify a smaller value for <i>Prec.</i>
	If the rotation angle range is large, set the <i>Search mode</i> to <i>PT</i> .
Measurement parameter	If images that should be judged OK vary little, specify a larger value for <i>Candidate LV</i> .
	If the position precision is high, uncheck <i>Sub-pixel</i> .

2-3-7 Measurement Results for Which Output Is Possible (Flexible Search)

The following values can be output using processing items related to result output. It is also possible to reference measurement values from calculation expressions and other processing units.

Measurement items	Character string	Description
Judge	JG	Judgment results 0: No judgment (unmeasured) 1: Judgment result OK -1: Judgment result NG -10: Error (image format mismatch) -11: Error (unregistered model) -12: Error (insufficient memory) -20: Error (other errors)
Model No.	NO	Model No. of the highest correlation value when judgment result OK
Correlation	CR	Correlation value with the model
Position X	X	X coordinate of the position where the model is detected.
Position Y	Y	Y coordinate of the position where the model is detected.
Angle θ	TH	Angle of the position where the model is detected.

Measurement items	Character string	Description
Ref. position X	SX	X coordinate of the reference position of the registered model ^{*1}
Ref. position Y	SY	Y coordinate of the reference position of the registered model ^{*1}
Ref. angle	ST	Reference angle of registered model ^{*1}
Detection point RX	RX	X coordinate of detection point set when model was registered
Detection point RY	RY	Y coordinate of detection point set when model was registered

^{*1}. The reference position changes depending on the detected model. The central coordinates of each registered model will be the reference position.

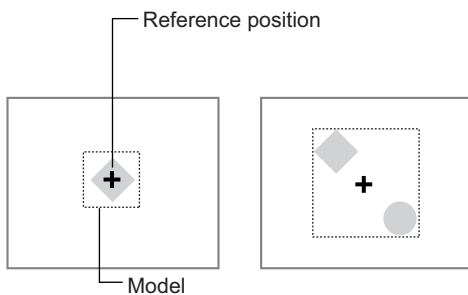

2-3-8 External Reference Tables (Flexible Search)

No.	Data name	Data ident	Set/Get	Data range
0	Judge	judge	Get only	0: No judgment (unmeasured), 1: Judgment result OK, -1: Judgment result NG, -10: Error (image format mismatch), -11: Error (unregistered model), -12: Error (insufficient memory), -20: Error (other errors)
5	Model No.	modelNo	Get only	0 to 4: Model No. for judgment result OK -1: Judgment result NG
6	Correlation value	correlation	Get only	0 to 100
7	Measure X	x	Get only	-99,999.9999 to 99,999.9999
8	Measure Y	y	Get only	-99,999.9999 to 99,999.9999
9	Measure angle	angle	Get only	-180 to 180
10	Reference X	referenceX	Get only	-99,999.9999 to 99,999.9999
11	Reference Y	referenceY	Get only	-99,999.9999 to 99,999.9999
12	Reference angle	referenceAngle	Get only	-180 to 180
13	Detection point X	detectionX	Get only	-99,999.9999 to 99,999.9999
14	Detection point Y	detectionY	Get only	-99,999.9999 to 99,999.9999
101	Output coordinates	outputCoordinate	Set/Get	0: After scroll 1: Before scroll
102	Calibration	calibration	Set/Get	0: OFF, 1: ON

No.	Data name	Data ident	Set/Get	Data range
103	Reflect to overall judgement	overallJudge	Set/Get	0: ON, 1: OFF
120	Search mode	searchMode	Set/Get	0: Correlation 1: Shape
121	With rotation	rotation	Set/Get	0: OFF, 1: ON
122	Upper limit of the rotation angle	endAngle	Set/Get	-180 to 180
123	Lower limit of the rotation angle	startAngle	Set/Get	-180 to 180
124	Skipping angle	angleSkip	Set/Get	1 to 30
125	Smart mode	smartMode	Set/Get	0: OFF, 1: ON
126	Stab.(CR)	stability	Set/Get	1 to 15
127	Prec.	accuracy	Set/Get	1 to 3
128	Stab.(SH)	searchSpeed	Set/Get	1 to 5
134	Sub-pixel	subPixel	Set/Get	0: OFF, 1: ON
135	Candidate Point Level	candidateLevel	Set/Get	0 to 100
136	Upper limit of measure X	upperX	Set/Get	-99,999.9999 to 99,999.9999
137	Lower limit of measure X	lowerX	Set/Get	-99,999.9999 to 99,999.9999
138	Upper limit of measure Y	upperY	Set/Get	-99,999.9999 to 99,999.9999
139	Lower limit of measure Y	lowerY	Set/Get	-99,999.9999 to 99,999.9999
140	Upper limit of the angle	upperAngle	Set/Get	-180 to 180
141	Lower limit of the angle	lowerAngle	Set/Get	-180 to 180
142	Upper limit of the corr.	upperCorrelation	Set/Get	0 to 100
143	Lower limit of the corr.	lowerCorrelation	Set/Get	0 to 100
6,002	Format	cameraColor	Set/Get	1: Monochrome camera 2: Color camera
95,000	figure0 Count	figArea0_count	Set/Get	1
95,001	figure0 Type	figArea0_fig0_type	Set/Get	8: Rectangle
95,002	figure0 mode	figArea0_fig0_mode	Set/Get	0: OR
95,014	figure0 Rectangle Upper left position X	figArea0_fig0_box_X0	Set/Get	-99,999 to 99,999
95,015	figure0 Rectangle Upper left position Y	figArea0_fig0_box_Y0	Set/Get	-99,999 to 99,999
95,016	figure0 Rectangle Lower right position X	figArea0_fig0_box_X1	Set/Get	-99,999 to 99,999
95,017	figure0 Rectangle Lower right position Y	figArea0_fig0_box_Y1	Set/Get	-99,999 to 99,999
95,099	figure0 Update	figArea0_update	Set only	1: Update

2-4 Sensitive Search

The registered models are automatically finely divided and matched in detail. Of the divided models, the one with the lowest correlation is output. Sensitive search is suitable when the difference between the model image and measurement image is small and regular searches do not produce differences in correlation.

Used in the Following Case

When identifying the shape of the divided area:

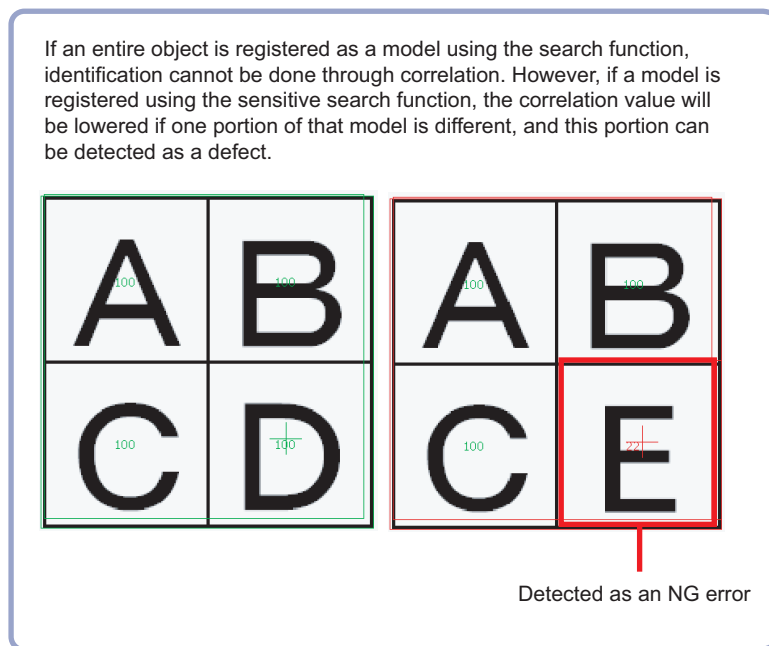

Precautions for Correct Use

Processing is different for color images and monochrome images. When the camera type used in the previous setup was changed to color or monochrome type, perform the settings again.

2-4-1 Settings Flow (Sensitive Search)

To set Sensitive Search, follow the steps below.

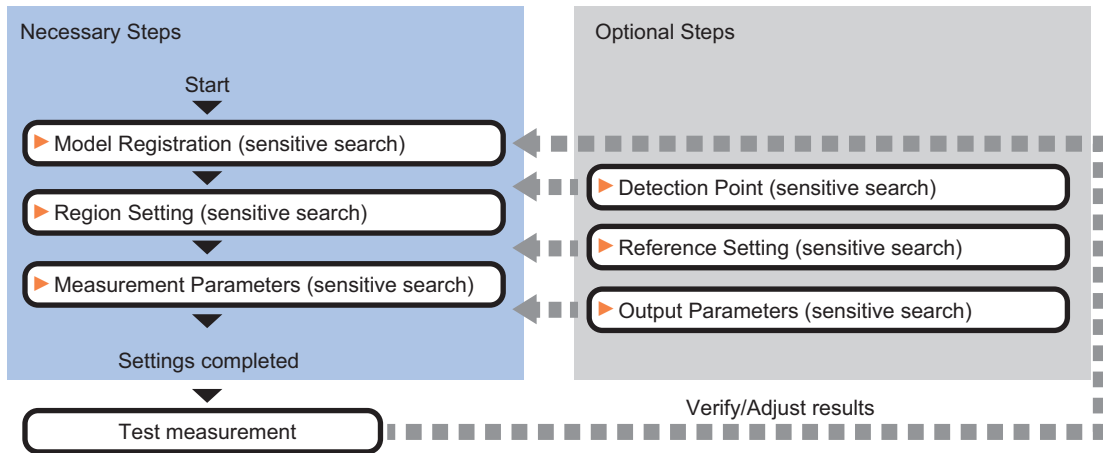

List of Sensitive Search Items

Item	Description
Model	This item registers the pattern characteristic of the measurement image as a model. Model parameter values can be changed as needed to address unstable measurement results or to increase the processing speed. Normally, the factory default value will be used. <i>2-4-2 Model Registration (Sensitive Search) on page 2-52</i>
Region setting	Sets the measurement area. It is possible to target the entire screen, but restricting the range can shorten the processing time. <i>2-4-3 Region Setting (Sensitive Search) on page 2-55</i>
Detection point	This item can be changed as necessary. Specify a position in the model that should be used as the detection coordinates during measurement. Usually, the central position of the set model is registered as the detection coordinates. <i>2-4-4 Detection Point (Sensitive Search) on page 2-55</i>
Ref. setting	This item can be changed as necessary. Specify the reference position within the camera's field of view. <i>2-4-5 Reference Setting (Sensitive Search) on page 2-57</i>
Measurement parameter	Sets processing conditions for measurement and judgment conditions for measurement results. Specify the criteria to judge the measurement result if the X and Y coordinates and the correlation with the model are OK. <i>2-4-6 Measurement Parameters (Sensitive Search) on page 2-59</i>
Output parameter	This item can be changed as necessary. Normally, the factory default value will be used. Use the output parameter to specify how to handle the coordinates. <i>2-4-7 Output Parameters (Sensitive Search) on page 2-60</i>

2-4-2 Model Registration (Sensitive Search)

Register the parts to measure as the model.

The position at the time of registration is also registered in the model information. Place the measurement object in the correct position when registering a model.

- 1** In the Item tab area, click **Model**.
When setting a new model, you do not have to click **Model**.
- 2** Use the drawing tools to specify the model registration range.
- 3** To save the entire image used for model registration, place a check at the *Save reg. model* option.
Also, when registering a model but not holding the disable setting for the sub-region set during the last time the model was registered, uncheck the *Keep disabled state* option.

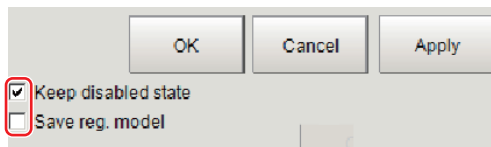

Setting item	Setting value [Factory default]	Description
Keep disabled state	<ul style="list-style-type: none"> • [Checked] • Unchecked 	When the model is registered, this holds the disable setting for the sub-region set during the last time the model was registered.
Save reg. model	<ul style="list-style-type: none"> • Checked • [Unchecked] 	To save the entire image used for model registration, place a check at this option.

- 4** Click **OK** in the *Figure setting* area.
 - **OK**: Changes the settings and returns to the previous menu.
 - **Cancel**: Changes are discarded. Returns to the previous menu.
 - **Apply**: Updates the settings without leaving edit window.

Changing Model Parameters

Model parameter values can be changed as needed to address unstable measurement results or to increase the processing speed. Normally, the factory default value will be used.

After changing a setting, re-register the model.

- 1** In the *Model parameter* area, set each item.

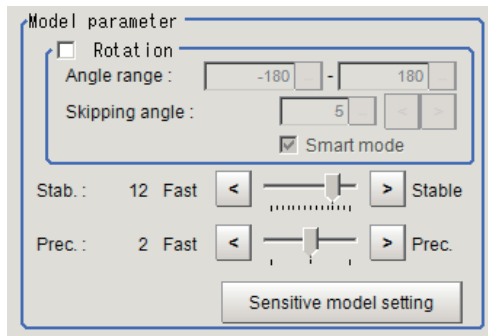

Setting item	Setting value [Factory default]	Description
Rotation	<ul style="list-style-type: none"> • Checked • [Unchecked] 	When the measurement object is rotating, place a check at <i>Rotation</i> and specify how many degrees the model created rotates each time and through what range of angles. A smaller skipping angle increases stability, but slows down the processing. The forward direction is clockwise.
Angle range	-180 to 180 [-180] to [180]	
Skipping angle	1 to 30 [5]	
Smart mode	<ul style="list-style-type: none"> • [Checked] • Unchecked 	Checking the <i>Smart mode</i> option enables a high-speed rotation search. However, the stability may be lowered when the model shape aspect ratio is large or when the NOT mask is used.
Stab.	1 to 15 The default value depend on the connected camera. [9] or [12]	Specify which is to have priority, measurement stability or speed. If lowering stability does not speed up processing, it is likely that many candidates have been detected. In this case, specify a larger value for <i>Candidate LV</i> or <i>Stab.</i> .
Prec.	1 to 3 [2]	Specify which is to have priority, measurement positional precision or speed.

Changing Sub-model Parameter

Set the *Sensitive model setting* as necessary.

- 1 Click **Sensitive model setting** in the model parameter.
- 2 Set up the Sub-model parameter.

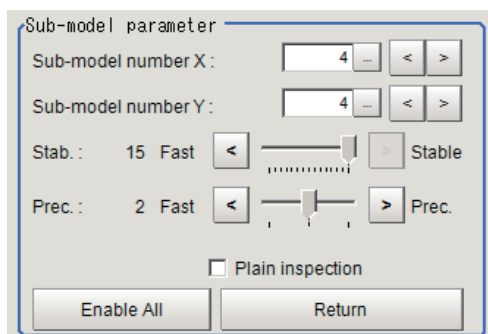

Setting item	Setting value [Factory default]	Description
Sub-model number X	0 to 10 [4]	This sets the number of divisions of the registered model in the X direction.
Sub-model number Y	0 to 10 [4]	This sets the number of divisions of the registered model in the Y direction.
Stab.	1 to 15 [12] or [15] The default value depend on the connected camera. 1	Specify which is to have priority, measurement stability or speed. If lowering stability does not speed up processing, it is likely that many candidates have been detected. In this case, specify a larger value for <i>Candidate LV</i> or <i>Stab.</i> .
Prec.	1 to 3 [2]	Specify which is to have priority, measurement positional precision or speed.
Plain inspection	<ul style="list-style-type: none"> • Checked • [Unchecked] 	Specify whether or not to inspect the plain region.

● Disabled setting

You can specify enable/disable of each sub-region.

- 1 Click the region you wish to disable and select *Disabled*.
To release the disabling of a region, click *Enable All*.

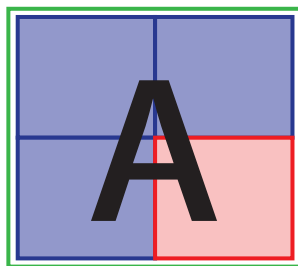

←Set as invalid

Divided model regions

Displaying/Re-Registering/Deleting a Model

The buttons described in the following table are available when a model registration image is saved. You can use these buttons to reconfirm images used for model registration, or re-registering the model after adjusting detail settings.

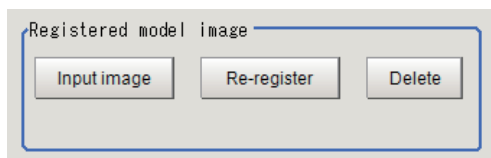

Setting item	Setting value	Description
Disp model/Input image	-	The model image display and input image display are switched.

Setting item	Setting value	Description
Re-register	-	Re-registers a model using the model registration image. When model parameters are changed, you can display the model registration image and re-register. This button is available when the model registration image is displayed.
Delete	-	Deletes a model.

2-4-3 Region Setting (Sensitive Search)

Use a rectangle to specify the area where the model is searched. Instead of measuring the entire input image, narrowing the measurement area shortens the processing time.

- 1** In the Item tab area, click **Region setting**.
- 2** Click **Edit**.
The *Figure Setting* area is displayed.
- 3** Specify the area in which to search for the model.
The rectangle covering the entire screen is set. Adjust the size and position of the rectangle.
- 4** Click **OK** in the *Figure setting* area.
 - **OK**: Changes the settings and returns to the previous menu.
 - **Cancel**: Changes are discarded. Returns to the previous menu.
 - **Apply**: Updates the settings without leaving edit window.

2-4-4 Detection Point (Sensitive Search)

Specify a position in the model that should be used as the detection coordinates during measurement. Usually, the central position of the set model is registered as the detection point. This function is used to change to any desired position.

A detection point can be set either directly or by referencing a unit.



Additional Information

After changing the detection point coordinates to another position, re-registering the model will change it back to the center coordinates of the model.

Specifying directly

Click a position on the image you want to use as a detection point, or input coordinate data for that point.

- 1** In the Item tab area, click **Detection point**.
In the *Display* area, the current detection point is displayed with a crosshair cursor.



- 2** In the *Method* area, select *Numerical*.

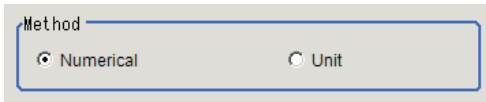

- 3** Click the position to be set as the detection point.



Additional Information

Displaying the image enlarged makes this clicking easier.
For details, refer to *Appendixes Basic Knowledge about Operations Using the Zoom Function in the Vision System FH/FHV Series User's Manual* (Cat. No. Z365).

- 4** Make fine adjustments using numeric value inputs or the arrow buttons as required.

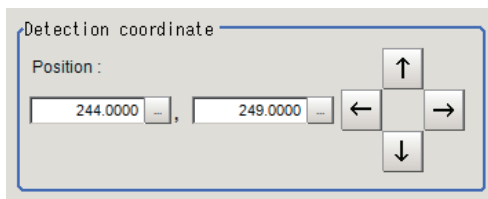

Referencing a unit

Set a detection point by referencing a detection point unit with registered X coordinate, Y coordinate and angle data.

- 1** In the Item tab area, click **Detection point**.
In the *Display* area, the current detection point is displayed with a crosshair cursor.
- 2** In the *Method* area, select *Unit*.



- 3** In the *Unit* area, select a detection point unit in the scene.

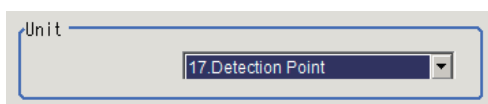

Performing the next measurement will display the detection point.

2-4-5 Reference Setting (Sensitive Search)

When the model is set, this position is automatically set at the same time as the reference position. This item can be set to change the reference position to any desired position. This is handy for measuring the position deviation from a certain position. A reference position can be set either directly or by referencing a unit.

Specifying Directly

Click a position on the image you want to use as a reference position, or input coordinate data for that point.

- 1 In the Item tab area, click **Ref. setting**.
In the *Display* area, the current reference position will be displayed as the crosshair cursor.



- 2 In the *Method* area, select *Numerical*.

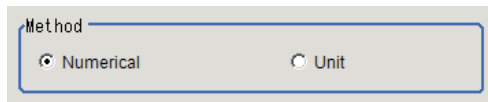

- 3 Click the position to be set as the reference.



Additional Information

Displaying the image enlarged makes this clicking easier.
For details, refer to *Appendixes Basic Knowledge about Operations Using the Zoom Function* in the *Vision System FH/FHV Series User's Manual* (Cat. No. Z365).

- 4 Make fine adjustments using numeric value inputs or the arrow buttons as required.

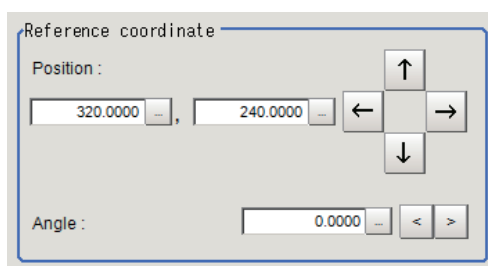

- 5 Set the reference angle with a numeric value.

- 6** To remeasure on the displayed image and set the reference, click **Measure ref.**.
To update the reference angle at the time of reference measurement, place a check at *Update the angle when measure ref.* .

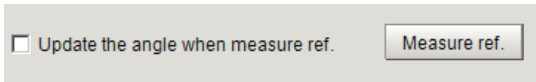

- 7** To use data before position compensation for the reference setting coordinates, place a check at *Use point coordinate before scroll.*

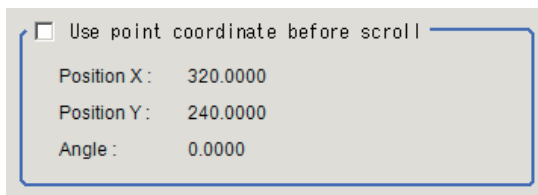

Precautions for Correct Use

If you check *Use point coordinate before scroll*, do not use the following processing items. Otherwise, correct search results cannot be obtained.

- Precise Calibration
- Calibration Data Reference

Referencing a Unit

Set a reference by referencing a detection point unit with registered X coordinate, Y coordinate and angle data.

- 1** In the Item tab area, click **Ref. setting**.
In the *Display* area, the current reference position will be displayed as the crosshair cursor.
- 2** In the *Method* area, select *Unit*.



- 3** In the *Unit* area, select a detection point unit in the scene.

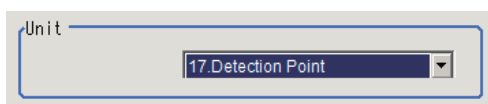

Performing the next measurement will display the reference.

2-4-6 Measurement Parameters (Sensitive Search)

Specify the sensitive search measurement conditions and the judgement conditions for the measurement results.

- 1 In the Item tab area, click **Measurement**.
- 2 In the *Measurement condition* area, specify a value for each item.

Setting item	Setting value [Factory default]	Description
Sub-pixel	<ul style="list-style-type: none"> • Checked • [Unchecked] 	When a check is placed at <i>sub-pixel</i> , the position information can be measured in units of sub-pixels. However, this requires more processing time.
Candidate LV	0 to 100 [60]	Specify the threshold value with which to detect candidate points in a rough search. Specify a smaller value when model search results are unreliable.
Sub-region margin	0 to 10 [6]	How large a region to use for the divided model search range for the divided model size is specified in units of pixels. If 6 is set, an area that is the model size expanded by 6 pixels up, down, left, and right is the search range.

- 3 When the setting has been changed, click **Measure** in the *Detail* area to verify whether measurements can be made correctly.

- 4 Set up the judgment condition.

Setting item	Setting value	Description
Position X	-99,999.9999 to 99,999.9999	Specify the range of X-axis shifting that is judged to be OK.
Position Y	-99,999.9999 to 99,999.9999	Specify the range of Y-axis shifting that is judged to be OK.
Angle θ	-180 to 180	Specify the range of angles that are judged to be OK.
Correlation	0 to 100	Specify the range of correlation values that are judged to be OK. However, when the correlation value of the measurement result is 0, the judgment result will be NG regardless of the lower limit setting.

Setting item	Setting value	Description
Deviation	For color cameras: 0 to 221 For monochrome cameras: 0 to 127	Specify the range of density deviations that are judged to be OK. The higher the proportion of plain sections, the higher this value. This is enabled when plain inspection is set in the sensitive model settings.
NG Sub-region	0 to 100	Specify the range of NG sub-region that are judged to be OK.

2-4-7 Output Parameters (Sensitive Search)

Specify how to treat the coordinates to be output to the external device as measurement results. This item can be changed if necessary. Normally, the factory default value will be used.



Precautions for Correct Use

After setting up the measurement parameters, changing the output parameters will cause measurement results to vary accordingly. If the output parameters have been changed, re-specify the measurement, too.

- 1 Click **Output parameter** in the Item tab area.
- 2 Specify each of the following items.

Setting item	Setting value [Factory default]	Description	
Output coordinates	<ul style="list-style-type: none"> • [After scroll] • Before scroll 	As measurement results, select whether to output coordinate values to external devices before or after the position deflection correction is applied.	
Calibration	<ul style="list-style-type: none"> • ON • [OFF] 	Select whether to reflect the calibration in the values output to the external device as measurement results. <ul style="list-style-type: none"> • ON: Output the coordinates converted into actual dimensions. • OFF: Output the camera coordinate values. 	
Reflect to overall judgment	<ul style="list-style-type: none"> • [ON] • OFF 	Enables choosing whether or not the judgement results of this processing unit is reflected in the scene overall judgment.	
Display cursor setting	Position	<ul style="list-style-type: none"> • [ON] • OFF 	The measurement coordinate position of the detected model is displayed at the cursor.
	Sub-region	<ul style="list-style-type: none"> • ON • [OFF] 	The coordinate position of the region with the lowest correlation value of the sub-regions is displayed at the cursor.

2-4-8 Key Points for Test Measurement and Adjustment (Sensitive Search)

The following content is displayed in the *Detail result* area as text.



Precautions for Correct Use

Executing test measurements will also update the measurement results and the figures in the image.

Displayed item	Description
Judge	Judgment results 0: No judgment (unmeasured) 1: Judgment result OK -1: Judgment result NG -10: Error (image format mismatch) -11: Error (unregistered model) -12: Error (insufficient memory) -20: Error (other errors)
Correlation	Lowest correlation value in the sub-region
Position X	X coordinate of the position where the model is detected.
Position Y	Y coordinate of the position where the model is detected.
Angle θ	Angle of the position where the model is detected.
Density deviation	Highest density deviation in the sub-region
NG sub-region	NG region count

Key Points for Adjustment (Sensitive Search)

Adjust the setting parameters referring to the following points.

● When searching other positions

Parameter to be adjusted	Remedy
Model parameter	Specify a larger value for the <i>Prec.</i>
	If the measurement results are unstable only when <i>Rotation</i> is selected, specify a smaller value for the <i>Skipping angle</i> .
	When <i>Rotation</i> is selected, if the model shape is complex, uncheck the <i>Smart mode</i> option.
	If the model image consists of detailed figures, specify a larger value for <i>Stab</i> .
Sub-model parameter	If images that should be judged OK vary greatly, specify a larger value for <i>Sub-model number X</i> and " <i>Sub-model number Y</i> ".
Measurement parameter	If the precision is low, place a check at <i>Sub-pixel</i> .
	If images that should be judged OK vary greatly, specify a smaller value for <i>Candidate LV</i> .
	If images that should be judged OK vary greatly, specify a larger value for <i>Sub-region margin</i> .

● When the judgement is NG (insufficient memory)

Parameter to be adjusted	Remedy
Region setting	Make the search region as small as possible.
Model parameter	Bring <i>Stab</i> close to the factory default value.
	Bring the <i>Skipping angle</i> close to the factory default value.
	Specify a smaller value for <i>Prec.</i>
Sub-model parameter	Specify a larger value for <i>Sub-model number X</i> and <i>Sub-model number Y</i> .

● When the processing speed is slow

Parameter to be adjusted	Remedy
Region setting	Make the search region as small as possible.
Model registration	Make the area to register as the model as small as possible.
Model parameter	If the model image is a simple figure or a large figure, specify a smaller value for <i>Stab</i> .
	If lowering stability does not speed up processing, it is likely that many candidates have been detected. Raise the <i>Candidate LV</i> in <i>Measurement</i> .
	When <i>Rotation</i> is selected and the model image is a simple figure, specify a larger value for the <i>Skipping angle</i> .
	When <i>Rotation</i> is selected and the model image is a simple figure, place a check at the <i>Smart mode</i> .
	If the position precision is high, specify a smaller value for <i>Prec</i> .
Sub-model parameter	If images that should be judged OK vary greatly, specify a larger value for <i>Sub-model number X</i> and <i>Sub-model number Y</i> ,
Measurement parameter	If images that should be judged OK vary little, specify a larger value for <i>Candidate LV</i> .
	If the position precision is high, uncheck <i>Sub-pixel</i> .

2-4-9 Measurement Results for Which Output Is Possible (Sensitive Search)

The following values can be output using processing items related to result output. It is also possible to reference measurement values from calculation expressions and other processing units.

Measurement items	Character string	Description
Judge	JG	Judgment results 0: No judgment (unmeasured) 1: Judgment result OK -1: Judgment result NG -10: Error (image format mismatch) -11: Error (unregistered model) -12: Error (insufficient memory) -20: Error (other errors)
Correlation	CR	Correlation value with the model
Density deviation	NO	Density deviation
Position X	X	X coordinate of the position where the model is detected.
Position Y	Y	Y coordinate of the position where the model is detected.
Angle θ	TH	Angle of the position where the model is detected.
Ref. position X	SX	X coordinate of the reference position of the registered model
Ref. position Y	SY	Y coordinate of the reference position of the registered model
Ref. angle	ST	Reference angle of registered model
Detection point RX	RX	X coordinate of detection point set when model was registered

Measurement items	Character string	Description
Detection point RY	RY	Y coordinate of detection point set when model was registered
NG sub-region	CT	NG region count
Sub-region Number	AN	Region number with the lowest correlation value
Sub-region Number (X)	ANX	X direction column number for the output region
Sub-region Number (Y)	ANY	Y direction line number for the output region
Sub-region Pos. X	DX	X coordinate of the detected sub-region
Sub-region Pos. Y	DY	Y coordinate of the detected sub-region
Correlation (sub-region N) (N = 0 to 99)	CRN	Correlation value (sub-region N)
Deviation (sub-region N) (N = 0 to 99)	DVN	Deviation (sub-region N)

2-4-10 External Reference Tables (Sensitive Search)

No.	Data name	Data ident	Set/Get	Data range
0	Judge	judge	Get only	0: No judgment (unmeasured), 1: Judgment result OK, -1: Judgment result NG, -10: Error (image format mismatch), -11: Error (unregistered model), -12: Error (insufficient memory), -20: Error (other errors)
1	Correlation value	correlation	Get only	0 to 100
2	Deviation	deviation	Get only	For color cameras: 0.000 to 219.9705 For monochrome cameras: 0.000 to 127.000
3	Measure X	searchPositionX	Get only	-99,999.9999 to 99,999.9999
4	Measure Y	searchPositionY	Get only	-99,999.9999 to 99,999.9999
5	Measure angle	angle	Get only	-180 to 180
6	Detection point X	detectionX	Get only	-99,999.9999 to 99,999.9999
7	Detection point Y	detectionY	Get only	-99,999.9999 to 99,999.9999
8	Reference X	referenceX	Get only	-99,999.9999 to 99,999.9999
9	Reference Y	referenceY	Get only	-99,999.9999 to 99,999.9999
10	Reference angle	referenceAngle	Get only	-180 to 180
11	NG Sub-region	count	Get only	0 to 100
12	Sub-region No.	areaNum	Get only	0 to 99
13	Sub-region No.(X)	areaNumX	Get only	0 to 9
14	Sub-region No.(Y)	areaNumY	Get only	0 to 9
15	Sub-region Pos. X	positionX	Get only	-99,999.9999 to 99,999.9999
16	Sub-region Pos. Y	positionY	Get only	-99,999.9999 to 99,999.9999
101	Output coordinates	outputCoordinate	Set/Get	0: After scroll 1: Before scroll
102	Calibration	calibration	Set/Get	0: OFF, 1: ON
103	Reflect to overall judgement	overallJudge	Set/Get	0: ON, 1: OFF

No.	Data name	Data ident	Set/Get	Data range
121	With rotation	rotation	Set/Get	0: OFF, 1: ON
122	Upper limit of the rotation angle	endAngle	Set/Get	-180 to 180
123	Lower limit of the rotation angle	startAngle	Set/Get	-180 to 180
124	Skipping angle	angleSkip	Set/Get	1 to 30
125	Smart mode	smartMode	Set/Get	0: OFF, 1: ON
126	Stab.	stability	Set/Get	1 to 15
127	Prec.	accuracy	Set/Get	1 to 3
129	Reference X	referencePosX	Set/Get	0 to 99,999.9999
130	Reference Y	referencePosY	Set/Get	0 to 99,999.9999
131	Reference angle	referencePosAngle	Set/Get	-180 to 180
132	Detection point X	detectionPosX	Set/Get	0 to 99,999.9999
133	Detection point Y	detectionPosY	Set/Get	0 to 99,999.9999
134	Sub-pixel	subPixel	Set/Get	0: OFF, 1: ON
135	Candidate Point Level	candidateLevel	Set/Get	0 to 100
136	Upper limit of measure X	upperX	Set/Get	-99,999.9999 to 99,999.9999
137	Lower limit of measure X	lowerX	Set/Get	-99,999.9999 to 99,999.9999
138	Upper limit of measure Y	upperY	Set/Get	-99,999.9999 to 99,999.9999
139	Lower limit of measure Y	lowerY	Set/Get	-99,999.9999 to 99,999.9999
140	Upper limit of the angle	upperAngle	Set/Get	-180 to 180
141	Lower limit of the angle	lowerAngle	Set/Get	-180 to 180
142	Upper limit of the corr.	upperCorrelation	Set/Get	0 to 100
143	Lower limit of the corr.	lowerCorrelation	Set/Get	0 to 100
144	Save registered model	savemdlimg	Set/Get	0: OFF, 1: ON
145	Upper limit of deviation	upperDeviation	Set/Get	For color cameras: 0 to 221 For monochrome cameras: 0 to 127
146	Lower limit of deviation	lowerDeviation	Set/Get	For color cameras: 0 to 221 For monochrome cameras: 0 to 127
147	Upper limit of NG Sub-region	upperCount	Set/Get	0 to 100
148	Lower limit of NG Sub-region	lowerCount	Set/Get	0 to 100
149	Sub-region stab.	innerStability	Set/Get	1 to 15
150	Sub-region prec.	innerAccuracy	Set/Get	1 to 3
151	Sub-model number X	separateX	Set/Get	1 to 10
152	Sub-model number Y	separateY	Set/Get	1 to 10

No.	Data name	Data ident	Set/Get	Data range
153	Plain inspection	plainInspection	Set/Get	0: OFF, 1: ON
154	NG Sub-region(155,156 setting/acquisition target)	getAreaNo	Set/Get	1 to 100
155	Enabled/disabled of sub-region	areaEnabled	Set/Get	0: OFF, 1: ON
156	Type of sub-region	arealtemKind	Set/Get	-1: Not Unit,0: Search, 1: Color Data
157	Display cursor(position)	outputMainArea	Set/Get	0: OFF, 1: ON
158	Display cursor(Sub-region)	outputSubArea	Set/Get	0: OFF, 1: ON
159	Sub-region margin	areaMargin	Set/Get	0 to 10
163	Display Parameter	displayParameter	Set/Get	0: Position, 1: Correlation, 2: Deviation, 3: NG Sub-region
165	Disabled region retention flag	disableKeepFlag	Set/Get	0: Not retained, 1: Retained
168	Setting unit of reference coordinate	refUnitNo	Set/Get	-1 to 9,999
169	Setting type of reference coordinate	refSettingType	Set/Get	0: Numerical, 1: Unit
170	Update the reference angle	updateAngleFlg	Set/Get	0: Not update, 1: Update
171	Setting unit of detection coordinate	detUnitNo	Set/Get	-1 to 9,999
172	Setting type of detection coordinate	detSettingType	Set/Get	0: Numerical, 1: Unit
173	Use point coordinate before scroll	beforeScrollRefMode	Set/Get	0: Not use, 1: Use
174	Reference X before scroll	beforeScrollRefPosX	Set/Get	-99,999.9999 to 99,999.9999
175	Reference Y before scroll	beforeScrollRefPosY	Set/Get	-99,999.9999 to 99,999.9999
176	Angle before scroll	beforeScrollRefAngle	Set/Get	-180 to 180
1,000+N (N=0 to 99)	Correlation value of sub-region	CR00 to CR99	Get only	0 to 100
1,100+N (N=0 to 99)	Deviation of sub-region	DV00 to DV99	Get only	For color cameras: 0.000 to 219.9705 For monochrome cameras: 0.000 to 127.000
6,002	Format	cameraColor	Set/Get	1: Monochrome camera 2: Color camera
91,000	figure0 Count	figArea0_count	Set/Get	1
91,001	figure0 Type	figArea0_fig0_type	Set/Get	8: Rectangle
91,002	figure0 mode	figArea0_fig0_mode	Set/Get	0: OR
91,014	figure0 Rectangle Upper left position X	figArea0_fig0_box_X0	Set/Get	-99,999 to 99,999
91,015	figure0 Rectangle Upper left position Y	figArea0_fig0_box_Y0	Set/Get	-99,999 to 99,999

No.	Data name	Data ident	Set/Get	Data range
91,016	figure0 Rectangle Lower right position X	figAr- ea0_fig0_box_X1	Set/Get	-99,999 to 99,999
91,017	figure0 Rectangle Lower right position Y	figAr- ea0_fig0_box_Y1	Set/Get	-99,999 to 99,999
91,099	figure0 Update	figArea0_update	Set only	1: Update

2-5 ECM Search

This processing item can not be used in the FHV series.

This processing item searches the input image for parts having a high degree of similarity to the target mark (model), and measures its correlation value (similarity) and position.

In a normal search, image pattern models are used that look at the color and light/dark information, but in an ECM search, models are used that look at the profile information. Therefore, this processing assures a reliable search even for low-contrast or noisy images.

Used in the Following Case

To measure the location of a mark:

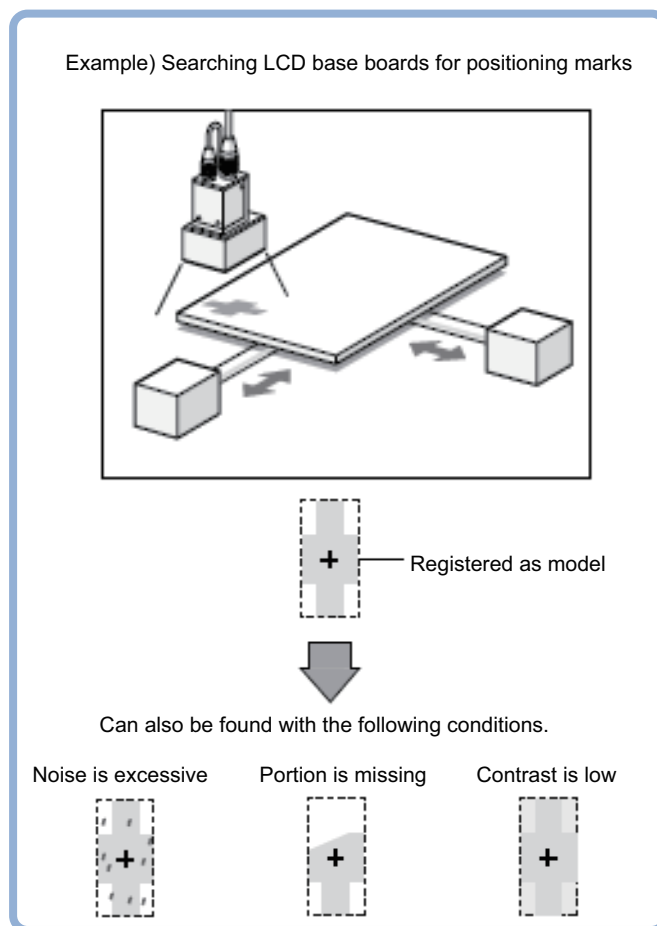

Precautions for Correct Use

Processing is different for color images and monochrome images. When the camera type used in the previous setup was changed to color or monochrome type, perform the settings again.

2-5-1 Settings Flow (ECM Search)

To set ECM Search, follow the steps below.

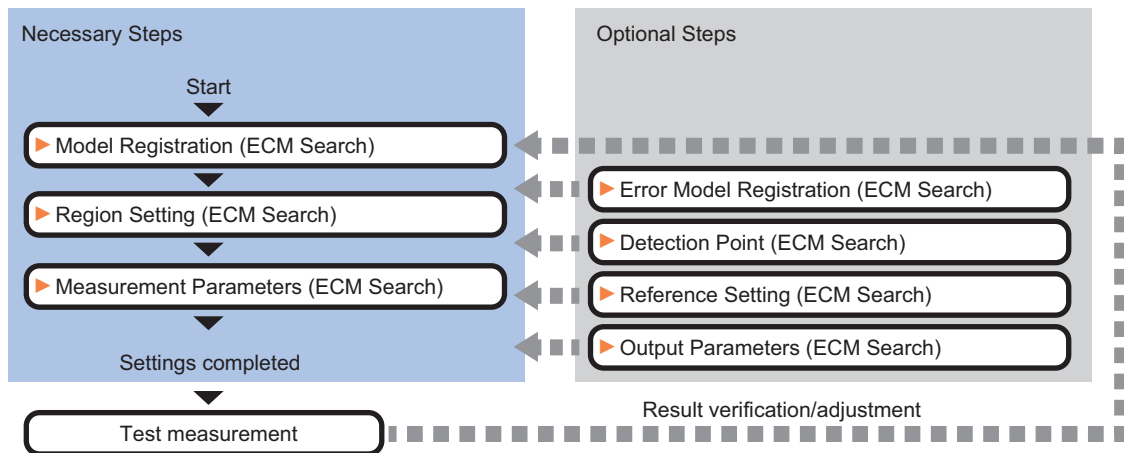

List of ECM Search Items

Item	Description
Model	This item registers the pattern characteristic of the measurement image as a model. Model parameter values can be changed as needed to address unstable measurement results or to increase the processing speed. Normally, the factory default value will be used. <i>2-5-2 Model Registration (ECM Search) on page 2-69</i>
Error model	This item can be changed if necessary. As an error model, register a model with similar characteristics to the registered one, but with its correlation value lowered when measured. <i>2-5-3 Error Model Registration (ECM Search) on page 2-72</i>
Region setting	Sets the measurement area. It is possible to target the entire screen, but restricting the range can shorten the processing time. <i>2-5-4 Region Setting (ECM Search) on page 2-72</i>
Detection point	This item can be changed as necessary. Specify a position in the model that should be used as the detection coordinates during measurement. Usually, the central position of the set model is registered as the detection coordinates. <i>2-5-5 Detection Point (ECM Search) on page 2-73</i>
Ref. setting	This item can be changed as necessary. Specify the reference position within the camera's field of view. <i>2-5-6 Reference Setting (ECM Search) on page 2-74</i>
Measurement parameter	Sets processing conditions for measurement and judgment conditions for measurement results. Specify the criteria to judge the measurement result if the X and Y coordinates and the correlation with the model are OK. <i>2-5-7 Measurement Parameters (ECM Search) on page 2-77</i>
Output parameter	This item can be changed as necessary. Normally, the factory default value will be used. Use the output parameter to specify how to handle the coordinates. <i>2-5-8 Output Parameters (ECM Search) on page 2-78</i>

2-5-2 Model Registration (ECM Search)

Register the pattern characteristic of the measurement object as a model. In an ECM search, only the image profile information is registered.



Precautions for Correct Use

- For ECM search, 6 pixels at each end of an image cannot be registered as a part of the model.
- If a model is re-registered, the error model is deleted. Register error models when re-registering a model.



Additional Information

When a model is registered, the center coordinate of the model is registered as the detection point coordinate. A detection point is a point output as a measurement value.

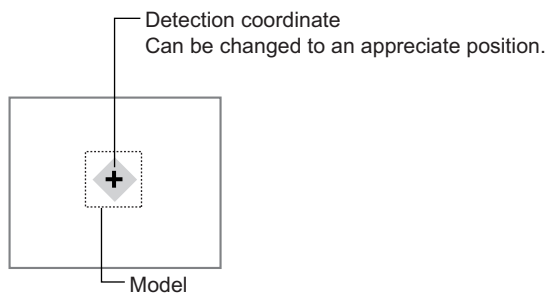

- 1** In the Item tab area, click **Model**.
When setting a new model, you do not have to click **Model**.
- 2** Use the drawing tools to specify the model registration range.
- 3** Click **OK** in the *Figure setting* area.
 - **OK**: Changes the settings and returns to the previous menu.
 - **Cancel**: Changes are discarded. Returns to the previous menu.
 - **Apply**: Updates the settings without leaving edit window.
- 4** Click **Edge extraction**, then confirm the edge extraction image.
If there is a break in the outline of the measurement object, adjust the edge level.
For details, refer to *Adjusting the Edge Level* on page 2-71.
- 5** If there is unnecessary profile information in the model, click **Mask register** to set the mask.
For details, refer to *Mask any Unnecessary Items* on page 2-71.
- 6** To check the model display, click **Display model**.
The registered model image is displayed in the image display area.

Changing Model Parameters

Model parameter values can be changed as needed to address unstable measurement results or to increase the processing speed. Normally, the factory default value will be used.

After changing a setting, check whether measurement can be done properly by performing an actual measurement.

- 1 In the *Model parameter* area, set each item.

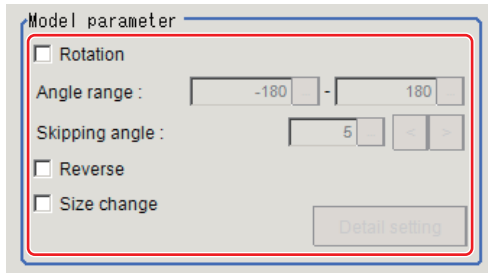

Setting item	Setting value [Factory default]	Description
Rotation	<ul style="list-style-type: none"> • Checked • [Unchecked] 	When the measurement object is rotating, place a check at <i>Rotation</i> and specify how many degrees the model created rotates each time and through what range of angles. A smaller skipping angle increases stability, but slows down the processing. The forward direction is clockwise.
Angle range	-180 to 180 [-180] to [180]	
Skipping angle	1 to 30 [5]	
Reverse	<ul style="list-style-type: none"> • Checked • [Unchecked] 	Specify whether to allow the reverse of light and dark for the model.
Size change	<ul style="list-style-type: none"> • Checked • [Unchecked] 	Specify whether to allow size change for the model. When checked, click Detail setting and specify a value for each item.

- 2 When the *Size change* option is checked, click **Detail setting**.

The *Model parameter: Size change* area is displayed.

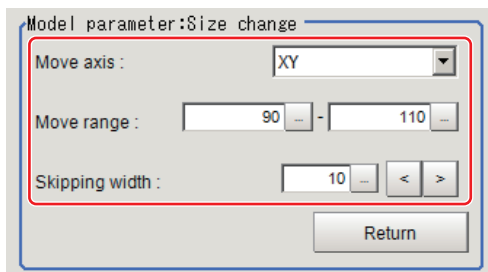

Setting item	Setting value [Factory default]	Description
Move axis	<ul style="list-style-type: none"> • [XY] • X • Y 	Specify the model variable direction.
Move range	50 to 150 (%) [90] to [110]	Specify the range in which to change the model size.

Setting item	Setting value [Factory default]	Description
Skipping width	1 to 99 (%) [10]	Specify the skipping percentage within the move range by which to change models being created. A smaller skipping width increases precision, but slows down the processing.

- 3 Click **Return**.
The *Model parameter* area is displayed.

Mask any Unnecessary Items

By registering a mask, the part you do not want included in the model is excluded.

- 1 Click **Mask register**.

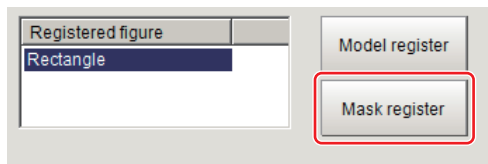

- 2 Draw the mask figure using the drawing tools.
- 3 Click **OR/NOT**.
The mask figure is displayed in red.
- 4 Click **OK** in the *Figure setting* area.
 - **OK**: Changes the settings and returns to the previous menu.
 - **Cancel**: Changes are discarded. Returns to the previous menu.
 - **Apply**: Updates the settings without leaving edit window.

Adjusting the Edge Level

In an ECM search, processing is executed on the edge extraction image. Change this item as necessary when the edge is not extracted or is extracted along with noise.



Precautions for Correct Use

In model registration, extract as much of the edge as possible, then delete noise etc. in the mask registration to register the entire edge of the model. On the other hand, when measuring, even if the edge has skips, an image with the noise suppressed makes it possible to search the model stably. To set separate edge extraction conditions for model registration and for measuring, after registering the model, change the edge extraction conditions.

- 1 In the Item tab area, click **Edge extraction**.
- 2 Set the items in the *Edge extraction setting* area.

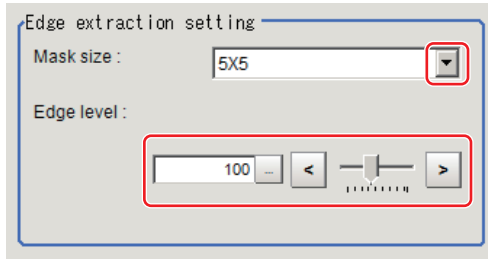

Setting item	Setting value [Factory default]	Description
Mask size	<ul style="list-style-type: none"> • 3x3 • [5x5] • 7x7 • 9x9 	Select the range of pixels which are used to extract the edge. With a larger <i>mask size</i> , search is less affected by variation in pixels.
Edge level	0 to 255 [100]	Change this when the edge is hard to see due to low contrast against the background or when unnecessary background noise must be removed. The smaller the value, the easier it is to find edges. The larger the value, the less noise will affect finding edges.

2-5-3 Error Model Registration (ECM Search)

Even for an image pattern with similar feature sections (for example "P" and "R"), if the model is registered as an error model, the correlation value is lower and measurement mistakes can be prevented. Only one error model can be registered.



Precautions for Correct Use

Upon re-registering a model, error models are deleted. Register error models when re-registering a model. Register error models when re-registering a model.

- 1** In the Item Tab area, click **Error model**.
- 2** Display the error model image.
Register the error model with the same procedure as for model registration.

2-5-4 Region Setting (ECM Search)

Use a rectangle to specify the area where the model is searched. Instead of measuring the entire input image, narrowing the measurement area shortens the processing time.

- 1** In the Item tab area, click **Region setting**.
- 2** Click **Edit**.
The *Figure Setting* area is displayed.
- 3** Specify the area in which to search for the model.
The rectangle covering the entire screen is set. Adjust the size and position of the rectangle.

- 4 Click **OK** in the *Figure setting* area.
 - **OK**: Changes the settings and returns to the previous menu.
 - **Cancel**: Changes are discarded. Returns to the previous menu.
 - **Apply**: Updates the settings without leaving edit window.

2-5-5 Detection Point (ECM Search)

Specify a position in the model that should be used as the detection coordinates during measurement. Usually, the central position of the set model is registered as the detection point. This function is used to change to any desired position.

A detection point can be set either directly or by referencing a unit.



Additional Information

After changing the detection point coordinates to another position, re-registering the model will change it back to the center coordinates of the model.

Specifying directly

Click a position on the image you want to use as a detection point, or input coordinate data for that point.

- 1 In the Item tab area, click **Detection point**.
In the *Display* area, the current detection point is displayed with a crosshair cursor.



- 2 In the *Method* area, select *Numerical*.

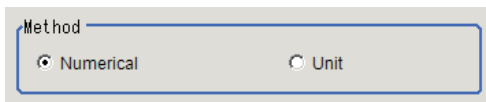

- 3 Click the position to be set as the detection point.



Additional Information

Displaying the image enlarged makes this clicking easier.
For details, refer to *Appendixes Basic Knowledge about Operations Using the Zoom Function* in the *Vision System FH/FHV Series User's Manual* (Cat. No. Z365).

- 4 Make fine adjustments using numeric value inputs or the arrow buttons as required.

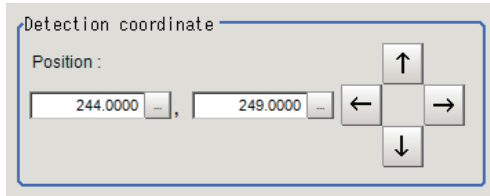

Referencing a unit

Set a detection point by referencing a detection point unit with registered X coordinate, Y coordinate and angle data.

- 1 In the Item tab area, click **Detection point**.
In the *Display* area, the current detection point is displayed with a crosshair cursor.
- 2 In the *Method* area, select *Unit*.

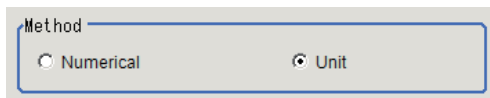

- 3 In the *Unit* area, select a detection point unit in the scene.

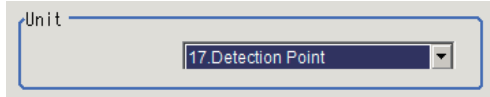

Performing the next measurement will display the detection point.

2-5-6 Reference Setting (ECM Search)

When the model is set, this position is automatically set at the same time as the reference position. This item can be set to change the reference position to any desired position. This is handy for measuring the position deviation from a certain position.

A reference position can be set either directly or by referencing a unit.

Specifying Directly

Click a position on the image you want to use as a reference position, or input coordinate data for that point.

- 1 In the Item tab area, click **Ref. setting**.
In the *Display* area, the current reference position will be displayed as the crosshair cursor.



- 2** In the *Method* area, select *Numerical*.

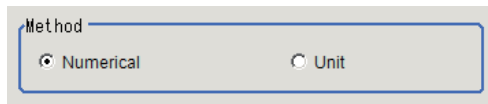

- 3** Click the position to be set as the reference.



Additional Information

Displaying the image enlarged makes this clicking easier.
For details, refer to *Appendixes Basic Knowledge about Operations Using the Zoom Function in the Vision System FH/FHV Series User's Manual (Cat. No. Z365)*.

- 4** Make fine adjustments using numeric value inputs or the arrow buttons as required.

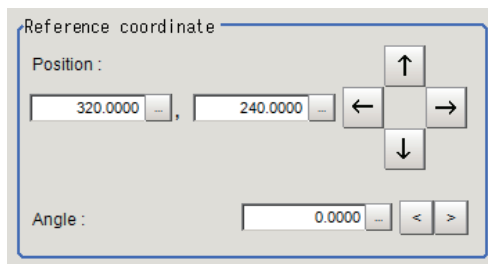

- 5** Set the reference angle with a numeric value.

- 6** To remeasure on the displayed image and set the reference, click **Measure ref.**.
To update the reference angle at the time of reference measurement, place a check at *Update the angle when measure ref.* .

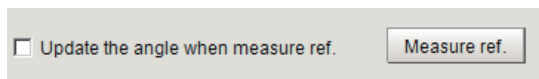

- 7** To use data before position compensation for the reference setting coordinates, place a check at *Use point coordinate before scroll*.

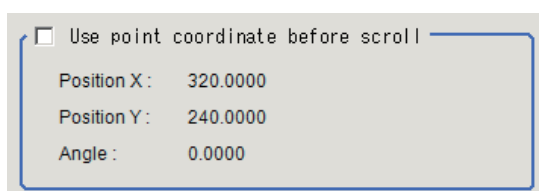



Precautions for Correct Use

If you check *Use point coordinate before scroll*, do not use the following processing items. Otherwise, correct search results cannot be obtained.

- Precise Calibration
 - Calibration Data Reference
-

Referencing a Unit

Set a reference by referencing a detection point unit with registered X coordinate, Y coordinate and angle data.

- 1 In the Item tab area, click **Ref. setting**.
In the *Display* area, the current reference position will be displayed as the crosshair cursor.
- 2 In the *Method* area, select *Unit*.



- 3 In the *Unit* area, select a detection point unit in the scene.

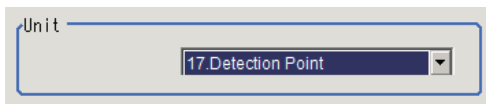

Performing the next measurement will display the reference.

2-5-7 Measurement Parameters (ECM Search)

This item specifies the judgement condition for measurement results. Specify the criteria to judge the measurement result if the X and Y coordinates and the correlation values with the model are OK.

- 1 In the Item tab area, click **Measurement**.
- 2 In the *Measurement condition* area, specify a value for each item.

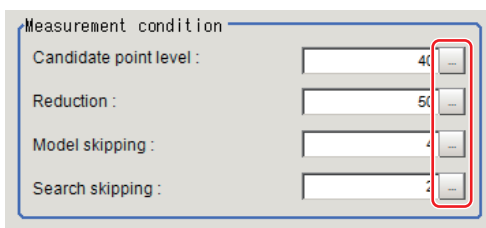

Setting item	Setting value [Factory default]	Description
Candidate LV	0 to 99 [40]	Specify the threshold value with which to detect candidate points in a rough search. Specify a smaller value when model search results are unreliable.
Reduction	10 to 100 [50]	Specify the percentage to which the input image and the model image are reduced during a rough search. The more the image is reduced, the faster the processing becomes, but search results may be unstable with a smaller image.
Model skipping	1 to 19 [4]	Specify how many pixels should be skipped when performing a rough search.

Setting item	Setting value [Factory default]	Description
Search skipping	1 to 9 [2]	Specify how many pixels are skipped when performing a search for the Search region .

- 3** When the setting has been changed, click **Measure** in the *Detail* area to verify whether measurements can be made correctly.

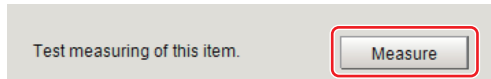

- 4** Set up the judgment condition.



Additional Information

The values beside each item are measurement results of the displayed image. Take these values into consideration to determine the upper and lower limit values.

Setting item	Setting value	Description
Position X	-99,999.9999 to 99,999.9999	Specify the range of X-axis shifting that is judged to be OK.
Position Y	-99,999.9999 to 99,999.9999	Specify the range of Y-axis shifting that is judged to be OK.
Angle θ	-180 to 180	Specify the range of angles that are judged to be OK.
Correlation	0 to 100	Specify the range of correlation values that are judged to be OK. However, when the correlation value of the measurement result is 0, the judgment result will be NG regardless of the lower limit setting.

When the ECM correlation value of the measurement result is 0, the judgement result will be NG regardless of the measurement parameters setting.

2-5-8 Output Parameters (ECM Search)

Specify how to treat the coordinates to be output to the external device as measurement results. This item can be changed if necessary. Normally, the factory default value will be used.



Precautions for Correct Use

After setting up the measurement parameters, changing the output parameters will cause measurement results to vary accordingly. If the output parameters have been changed, re-specify the measurement, too.

- 1** Click **Output parameter** in the Item tab area.
- 2** Specify each of the following items.

Setting item	Setting value [Factory default]	Description
Output coordinates	<ul style="list-style-type: none"> [After scroll] Before scroll 	As measurement results, select whether to output coordinate values to external devices before or after the position deflection correction is applied.

Setting item	Setting value [Factory default]	Description
Calibration	<ul style="list-style-type: none"> • ON • [OFF] 	Select whether to reflect the calibration in the values output to the external device as measurement results. <ul style="list-style-type: none"> • ON: Output the coordinates converted into actual dimensions. • OFF: Output the camera coordinate values.
Reflect to overall judgment	<ul style="list-style-type: none"> • [ON] • OFF 	Enables choosing whether or not the judgement results of this processing unit is reflected in the scene overall judgment.



Additional Information

For output coordinates and calibration, refer to *Appendixes Measurement Mechanism Handling Coordinates* in the *Vision System FH/FHV Series User's Manual (Cat. No. Z365)*.

2-5-9 Key Points for Test Measurement and Adjustment (ECM Search)

The following content is displayed in the *Detail result* area as text.

Displayed item	Description
Judge	Judgment results 0: No judgment (unmeasured) 1: Judgment result OK -1: Judgment result NG -10: Error (image format mismatch) -11: Error (unregistered model) -12: Error (insufficient memory) -20: Error (other errors)
Correlation	Correlation
Position X	X coordinate of the position where the model is detected.
Position Y	Y coordinate of the position where the model is detected.
Angle θ	Angle of the position where the model is detected.

The image specified in the Sub-image number in the image display setting is displayed in the *Image Display* area.

Sub-image number	Description of image to be displayed
0	Measurement image
1	Measurement image displayed with matching models overlaid Green: Matched model points Red: Unmatched model points

Key Points for Adjustment (ECM Search)

Adjust the setting parameters referring to the following points.

● When the measurement results are unstable

Parameter to be adjusted	Remedy
Measurement parameter	If images that should be judged OK vary greatly, specify a smaller value for <i>Candidate LV</i> .
	If the model image is small and unstable, specify a smaller value for the <i>Reduction</i> .
Model registration	Mask any unnecessary items.
	Lower the edge level.
	Register the error model.
Model parameter	If the measurement results are unstable only when <i>Rotation</i> is selected, specify a smaller value for the <i>Skipping angle</i> .

● When the processing speed is slow

Parameter to be adjusted	Remedy
Region setting	Make the search region as small as possible.
Model parameter	If images that should be judged OK vary little, specify a larger value for <i>Candidate LV</i> .
	When <i>Rotation</i> is selected and the model image is a simple figure, specify a larger value for the <i>Skipping angle</i> .
Measurement parameter	Specify a smaller value for the <i>Reduction</i> .
	Specify a larger value for the <i>Model skipping</i> .
	Specify a larger value for the <i>Search skipping</i> .

2-5-10 Measurement Results for Which Output Is Possible (ECM Search)

The following values can be output using processing items related to result output. It is also possible to reference measurement values from calculation expressions and other processing units.

Measurement items	Character string	Description
Judge	JG	Judgment results 0: No judgment (unmeasured) 1: Judgment result OK -1: Judgment result NG -10: Error (image format mismatch) -11: Error (unregistered model) -12: Error (insufficient memory) -20: Error (other errors)
Correlation	CR	Correlation value with the model
Position X	X	X coordinate of the position where the model is detected.
Position Y	Y	Y coordinate of the position where the model is detected.
Angle θ	TH	Angle of the position where the model is detected.
Meas. magnification MX	MX	Measurement magnification of X-axis direction of the detected model.

Measurement items	Character string	Description
Meas. magnification MY	MY	Measurement magnification of Y-axis direction of the detected model.
Ref. position X	SX	X coordinate of the reference position of the registered model
Ref. position Y	SY	Y coordinate of the reference position of the registered model
Ref. angle	ST	Reference angle of registered model
Detection point RX	RX	X coordinate of detection point set when model was registered
Detection point RY	RY	Y coordinate of detection point set when model was registered

2-5-11 External Reference Tables (ECM Search)

No.	Data name	Data ident	Set/Get	Data range
0	Judge	judge	Get only	0: No judgment (unmeasured), 1: Judgment result OK, -1: Judgment result NG, -10: Error (image format mismatch), -11: Error (unregistered model), -12: Error (insufficient memory), -20: Error (other errors)
5	Correlation value	correlation	Get only	0 to 100
6	Measure X	positionX	Get only	-99,999.9999 to 99,999.9999
7	Measure Y	positionY	Get only	-99,999.9999 to 99,999.9999
8	Angle theta	angle	Get only	-180 to 180
9	Magnification X	chgSizeX	Get only	50 to 150
10	Magnification Y	chgSizeY	Get only	50 to 150
11	Reference X	referenceX	Get only	-99,999.9999 to 99,999.9999
12	Reference Y	referenceY	Get only	-99,999.9999 to 99,999.9999
13	Reference angle	referenceAngle	Get only	-180 to 180
14	Detection point X	searchX	Get only	-99,999.9999 to 99,999.9999
15	Detection point Y	searchY	Get only	-99,999.9999 to 99,999.9999
101	Output coordinates	outputCoordinate	Set/Get	0: After scroll, 1: Before scroll
102	Calibration	calibration	Set/Get	0: OFF, 1: ON
103	Reflect to overall judgement	overallJudge	Set/Get	0: ON, 1: OFF
120	Mask size	maskSize	Set/Get	0: 3x3, 1: 5x5, 2: 7x7, 3: 9x9
121	Edge level	edgeLowerLevel	Set/Get	0 to 255
122	Detection point X	searchPosX	Set/Get	0 to 99,999.9999
123	Detection point Y	searchPosY	Set/Get	0 to 99,999.9999
124	Reference X	referencePosX	Set/Get	0 to 99,999.9999
125	Reference Y	referencePosY	Set/Get	0 to 99,999.9999
126	Upper limit of the corr.	upperCorrelation	Set/Get	0 to 100

No.	Data name	Data ident	Set/Get	Data range
127	Lower limit of the corr.	lowerCorrelation	Set/Get	0 to 100
128	Upper limit of measure X	upperX	Set/Get	-99,999.9999 to 99,999.9999
129	Lower limit of measure X	lowerX	Set/Get	-99,999.9999 to 99,999.9999
130	Upper limit of measure Y	upperY	Set/Get	-99,999.9999 to 99,999.9999
131	Lower limit of measure Y	lowerY	Set/Get	-99,999.9999 to 99,999.9999
132	Upper limit of the angle	upperAngle	Set/Get	-180 to 180
133	Lower limit of the angle	lowerAngle	Set/Get	-180 to 180
134	Candidate Point Level	candidateLevel	Set/Get	0 to 99
135	Model skipping	modelSkipping	Set/Get	1 to 19
136	Region skipping	searchSkipping	Set/Get	1 to 9
137	Reduction	reduction	Set/Get	10 to 100
138	With rotation	rotation	Set/Get	0: No rotation, 1: With rotation
139	Lower limit of the rotation angle	startAngle	Set/Get	-180 to 180
140	Upper limit of the rotation angle	endAngle	Set/Get	-180 to 180
141	Skipping angle	rotdeg	Set/Get	1 to 30
142	Size change	chgsize	Set/Get	0: No size change, 1: XY change, 2: X change, 3: Y change
143	Upper limit of the size change	upperchgsize	Set/Get	50 to 150
144	Lower limit of the size change	lowerchgsize	Set/Get	50 to 150
145	Size change skipping	chgsizsdeg	Set/Get	1 to 99
146	Reverse	reverse	Set/Get	0: No reverse, 1: Reverse
147	Setting unit of reference coordinate	refUnitNo	Set/Get	-1 to 9,999
148	Setting type of reference coordinate	refSettingType	Set/Get	0: Numerical, 1: Unit
149	Update the reference angle	updateAngleFlg	Set/Get	0: Not update, 1: Update
150	Reference angle	referencePosAngle	Set/Get	-180 to 180
151	Setting unit of detection coordinate	detUnitNo	Set/Get	-1 to 9,999
152	Setting type of detection coordinate	detSettingType	Set/Get	0: Numerical, 1: Unit
153	Use point coordinate before scroll	beforeScrollRefMode	Set/Get	0: Not use, 1: Use
154	Reference X before scroll	beforeScrollRefPosX	Set/Get	-99,999.9999 to 99,999.9999

No.	Data name	Data ident	Set/Get	Data range
155	Reference Y before scroll	beforeScrollRefPosY	Set/Get	-99,999.9999 to 99,999.9999
156	Angle before scroll	beforeScrollRefAngle	Set/Get	-180 to 180
6,002	Format	cameraColor	Set/Get	1: Monochrome camera 2: Color camera
91,000	figure0 Count	figArea0_count	Set/Get	1
91,001	figure0 Type	figArea0_fig0_type	Set/Get	8: Rectangle
91,002	figure0 mode	figArea0_fig0_mode	Set/Get	0: OR
91,014	figure0 Rectangle Upper left position X	figAr- ea0_fig0_box_X0	Set/Get	-99,999 to 99,999
91,015	figure0 Rectangle Upper left position Y	figAr- ea0_fig0_box_Y0	Set/Get	-99,999 to 99,999
91,016	figure0 Rectangle Lower right position X	figAr- ea0_fig0_box_X1	Set/Get	-99,999 to 99,999
91,017	figure0 Rectangle Lower right position Y	figAr- ea0_fig0_box_Y1	Set/Get	-99,999 to 99,999
91,099	figure0 Update	figArea0_update	Set only	1: Update

2-6 EC Circle Search

This processing item is not available in the FHV series.

This processing item searches the input image for parts having a high degree of similarity to the target circle mark (model), and measures its circle evaluated value (similarity) and position. In a normal search, image pattern models are used that look at the color and light/dark information. In EC Circle Search, however, models are used that look at the profile. Therefore, this processing assures a reliable search even for low-contrast or noisy images. It is also possible to measure the number of circles in the input image.

Used in the Following Case

This counts how many circles there are of the specified size. Since circles are extracted with the shape information of *Round*, the circles being deformed or dirty does not affect counting.

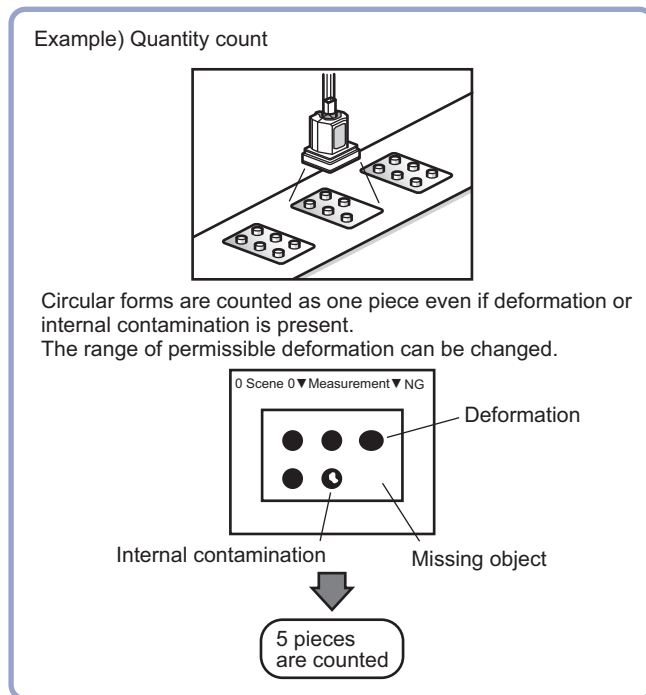

Precautions for Correct Use

Processing is different for color images and monochrome images. When the camera type used in the previous setup was changed to color or monochrome type, perform the settings again.

2-6-1 Settings Flow (EC Circle Search)

To set EC Circle Search, follow the steps below.

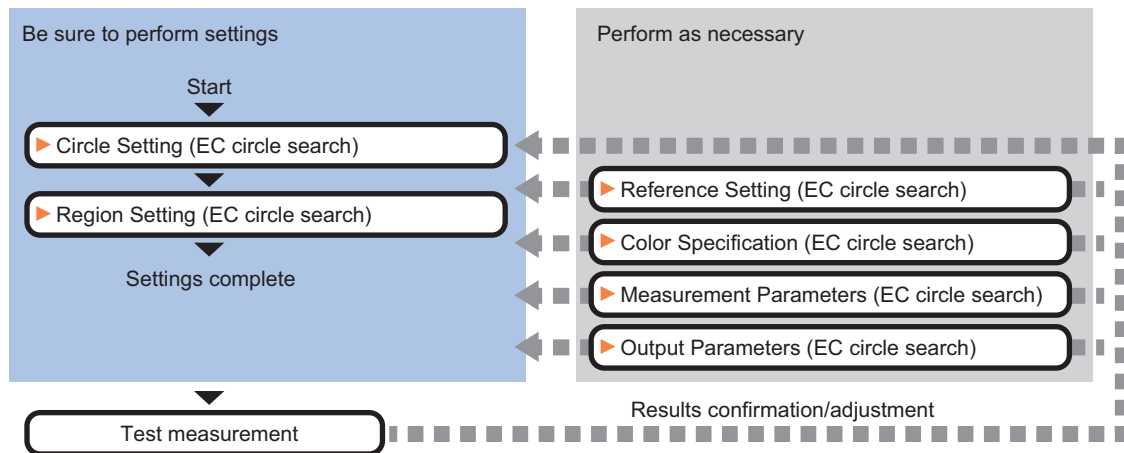

List of EC Circle Search Items

Item	Description
Circle setting	This item sets the size of the circle to search for. <i>2-6-2 Circle Setting (EC Circle Search) on page 2-86</i>
Region setting	Sets the measurement area. It is possible to target the entire screen, but restricting the range can shorten the processing time. <i>2-6-3 Region Setting (EC Circle Search) on page 2-87</i>
Ref. setting	This item can be changed as necessary. Specify the reference position within the camera's field of view. <i>2-6-4 Reference Setting (EC Circle Search) on page 2-87</i>
Color setting	This item is changed as necessary. Select the color of the circle and the background color. If no check is placed at color setting, the circle (edge) is extracted with the brightness difference. <i>2-6-5 Color Specification (EC Circle Search) on page 2-89</i>
Measurement parameter	This item changes the measurement parameter as necessary when the measurement result is unstable. <i>2-6-6 Measurement Parameters (EC Circle Search) on page 2-89</i>
Output parameter	This item can be changed as necessary. Normally, the factory default value will be used. Use the output parameter to specify how to handle the coordinates. <i>2-6-7 Output Parameters (EC Circle Search) on page 2-91</i>

2-6-2 Circle Setting (EC Circle Search)

Registers the size of the circle to search for.

Set the circle size only with the circumference figure.

- 1 In the Item Tab area, click **Circle register**.
When setting a new circle, you do not need to click **Circle register**.
- 2 Set the search circumference using the drawing tools.
- 3 Click **OK** in the *Figure setting* area.
 - **OK**: Changes the settings and returns to the previous menu.
 - **Cancel**: Changes are discarded. Returns to the previous menu.
 - **Apply**: Updates the settings without leaving edit window.
- 4 Click **Edge extraction** and set values.
For details, refer to *Extracting Edges* on page 2-86.

Extracting Edges

In an EC circle search, processing is executed on the edge extraction image. Change this item as necessary when the edge is not extracted or is extracted along with noise.

- 1 In the Item Tab area, click **Edge extraction**.
- 2 In the *Edge extraction setting* area, click  or ▼ and specify a value for each item.
The *Edge level* value can be specified by dragging the slider or clicking one of the buttons at either end of the slider.

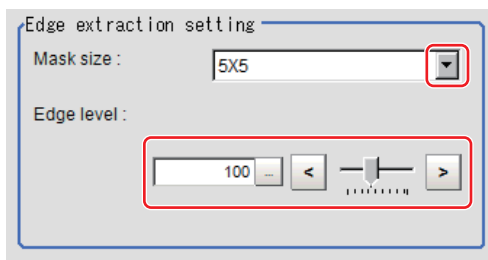

Setting item	Setting value [Factory default]	Description
Mask size	<ul style="list-style-type: none"> • 3x3 • [5x5] • 7x7 • 9x9 	Select the range of pixels which are used to extract the edge. With a larger <i>mask size</i> , search is less affected by variation in pixels.
Edge level	0 to 255 [100]	Change this when the edge is hard to see due to low contrast against the background or when unnecessary background noise must be removed. The smaller the value, the easier it is to find edges. The larger the value, the less noise will affect finding edges.

2-6-3 Region Setting (EC Circle Search)

Specify the rectangular area in which to search for the circle.

Instead of measuring the entire input image, narrowing the measurement area shortens the processing time.

- 1** In the Item tab area, click **Region setting**.
- 2** Click **Edit**.
The *Figure Setting* area is displayed.
- 3** Specify the area in which to search for the model.
The rectangle covering the entire screen is set. Adjust the size and position of the rectangle.
- 4** Click **OK** in the *Figure setting* area.
 - **OK**: Changes the settings and returns to the previous menu.
 - **Cancel**: Changes are discarded. Returns to the previous menu.
 - **Apply**: Updates the settings without leaving edit window.

2-6-4 Reference Setting (EC Circle Search)

When the model is set, this position is automatically set at the same time as the reference position.

This item can be set to change the reference position to any desired position. This is handy for measuring the position deviation from a certain position.

A reference position can be set either directly or by referencing a unit.

Specifying directly

Click a position on the image you want to use as a reference position, or input coordinate data for that point.

- 1** In the Item tab area, click **Ref. setting**.
In the *Display* area, the current reference position will be displayed as the crosshair cursor.



- 2** In the *Method* area, select *Numerical*.



- 3** Click the position to be set as the reference.



Additional Information

Displaying the image enlarged makes this clicking easier.

For details, refer to *Appendix Basic Knowledge about Operations Using the Zoom Function* in the *Vision System FH/FHV Series User's Manual* (Cat. No. Z365).

- 4 Make fine adjustments using numeric value inputs or the arrow buttons as required.

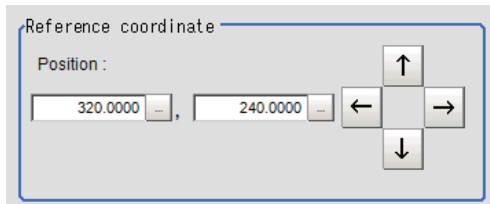

- 5 To remeasure on the displayed image and set the reference, click the **Measure ref.** button.
- 6 To use data before position compensation for the reference setting coordinates, place a check at *Use point coordinate before scroll*.

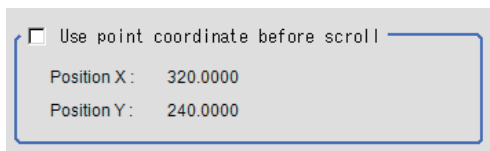

Referencing a Unit

Set a reference by referencing a detection point unit with registered X coordinate, Y coordinate and angle data.

- 1 In the Item tab area, click **Ref. setting**.
In the *Display* area, the current reference position will be displayed as the crosshair cursor.
- 2 In the *Method* area, select *Unit*.



- 3 In the *Unit* area, select a detection point unit in the scene.

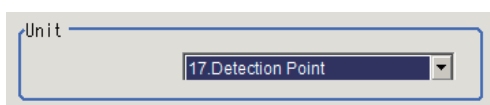

Performing the next measurement will display the reference.

2-6-5 Color Specification (EC Circle Search)

This item can be changed if necessary.

Select the color of the circle and the background color. If no check is placed at *Color setting*, the circle (edge) is extracted with the brightness difference.

- 1 In the Item tab area, click **Color setting**.
- 2 If necessary, place a check to *Color setting* in the *Color setting* area.

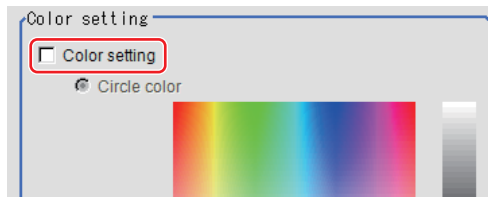

- 3 Specify a color.
Enclose the location on the image to be set as the circle and the background color with a rectangle. The average color of the enclosed range is set for R, G, and B.

R, G, and B values can also be set with numbers. To input the values, click  for each of R (red), G (green), and B (blue). Specify the circle color and the background color separately. For value input method, refer to *Appendixes Basic Knowledge about Operations Inputting Values* in the *Vision System FH/FHV Series User's Manual* (Cat. No. Z365).

2-6-6 Measurement Parameters (EC Circle Search)

This item specifies the judgement conditions for measurement results. Specify to what degree OK is still judged in relation to measurement result coordinates (X,Y) and the circle evaluation value with the model.

- 1 In the Item tab area, click **Measurement**.
- 2 Select the search type.



Setting item	Setting value [Factory default]	Description
Search type	<ul style="list-style-type: none"> • [Single search] • Multi search 	<ul style="list-style-type: none"> • Single search: This is set when there is one circle in the measurement range. • Multi search: This is set when there are multiple circles in the measurement range.

- 3 In the *Measurement condition* area, specify a value for each item.

For single search:

For multi search:

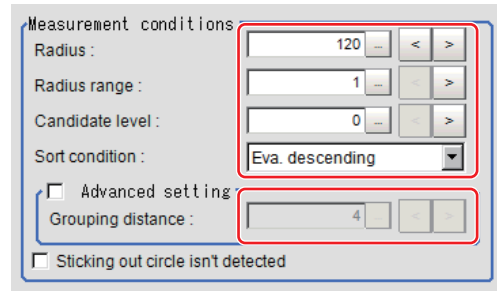
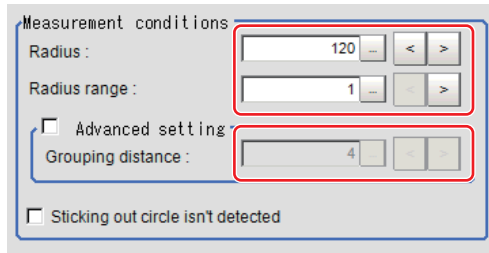

Setting item	Setting value [Factory default]	Description
Radius	1 to 9,999 [Radius drawn using circle resister]	This item sets the radius of the circle measured. This is displayed on the screen with a solid blue line.
Radius range	1 to 9,999 [1]	This measures the measured circle radius \pm the permitted radius width. This is displayed on the screen with a broken blue line.
Candidate LV (Multi search only)	0 to 100 [0]	Specify the threshold value used when detecting candidate points in an <i>EC circle search</i> . Specify a smaller value when model search results are unreliable.
Sort condition (Multi search only)	<ul style="list-style-type: none"> • X ascending • X descending • Y ascending • Y descending • Eva. ascending • [Eva. descending] • Radius ascending • Radius descending 	Specify the conditions by which the search number is re-assigned. When sorting referencing the X and Y coordinates, the upper left is the origin.
Advanced setting	<ul style="list-style-type: none"> • Checked • [Unchecked] 	Place a check at setting the grouping distance.
Grouping distance	1 to 10 [4]	When circles measured overlap, this sets the distance for distinguishing circles. The smaller this value, the easier to distinguish circles.
Sticking out circle isn't detected	<ul style="list-style-type: none"> • Checked • [Unchecked] 	Place a check here to include circles within the range only.

- For monochrome cameras:

For a monochrome camera only, the circle color parameters are displayed.

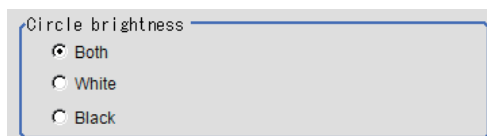

Setting item	Setting value [Factory default]	Description
Circle brightness	<ul style="list-style-type: none"> • [Both] • White • Black 	This sets the circle color with the brightness.

- 4** Set up the judgment condition.



Additional Information

The values beside each item are measurement results of the displayed image. Take these values into consideration to determine the upper and lower limit values.

Setting item	Setting value	Description
Measure pos X	-99,999.9999 to 99,999.9999	Specify the range of X-axis shifting that is judged to be OK.
Measure pos Y	-99,999.9999 to 99,999.9999	Specify the range of Y-axis shifting that is judged to be OK.
Evaluation	0 to 100	Specify the range of circle evaluated values that are judged to be OK.
Radius	0 to 99,999.9999	Set the range of radiuses that is judged to be OK.
Count	0 to 256	Specify the number of detections that are judged to be OK.

- 5** Perform the display setting if required.

Setting item	Setting value [Factory default]	Description
Display parameter	<ul style="list-style-type: none"> • [None] • Radius • Evaluation 	Select the type of measurement result to display on the image. The display setting applies only to the settings dialog box.

2-6-7 Output Parameters (EC Circle Search)

Specify how to treat the coordinates to be output to the external device as measurement results. This item can be changed if necessary. Normally, the factory default value will be used.



Precautions for Correct Use

After setting up the measurement parameters, changing the output parameters will cause measurement results to vary accordingly. If the output parameters have been changed, re-specify the measurement, too.

- 1** Click **Output parameter** in the Item tab area.
- 2** Specify each of the following items.

Setting item	Setting value [Factory default]	Description
Output coordinates	<ul style="list-style-type: none"> • [After scroll] • Before scroll 	As measurement results, select whether to output coordinate values to external devices before or after the position deflection correction is applied.
Calibration	<ul style="list-style-type: none"> • ON • [OFF] 	Select whether to reflect the calibration in the values output to the external device as measurement results. <ul style="list-style-type: none"> • ON: Output the coordinates converted into actual dimensions. • OFF: Output the camera coordinate values.

Setting item	Setting value [Factory default]	Description
Reflect to overall judgment	<ul style="list-style-type: none"> [ON] OFF 	Enables choosing whether or not the judgement results of this processing unit is reflected in the scene overall judgment.



Additional Information

For output coordinates and calibration, refer to *Appendixes Measurement Mechanism Handling Coordinates* in the *Vision System FH/FHV Series User's Manual (Cat. No. Z365)*.

2-6-8 Key Points for Test Measurement and Adjustment (EC Circle Search)

The following content is displayed in the *Detail result* area as text.

Displayed item	Description
Judge	Judgment results 0: No judgment (unmeasured) 1: Judgment result OK -1: Judgment result NG -10: Error (image format mismatch) -11: Error (unregistered model) -12: Error (insufficient memory) -20: Error (other errors)
Position X	X coordinate of the position where the model is detected.
Position Y	Y coordinate of the position where the model is detected.
Evaluation	Circle evaluated value of circles detected
Radius	Radius of circles detected
Count	Quantity of circles detected

Key Points for Adjustment (EC Circle Search)

Adjust the setting parameters referring to the following points.

● When the measurement results are unstable

Parameter to be adjusted	Remedy
Measurement parameter	If images that should be judged OK vary greatly, specify a smaller value for <i>Evaluation</i> .
Circle setting	Mask any unnecessary items. Lower the edge level.

● When the processing speed is slow

Parameter to be adjusted	Remedy
Region setting	Make the search region as small as possible.
Measurement parameter	If images that should be judged OK vary little, specify a larger value for <i>Evaluation</i> .

2-6-9 Measurement Results for Which Output Is Possible (EC Circle Search)

The following values can be output using processing items related to result output. It is also possible to reference measurement values from calculation expressions and other processing units.

Measurement items	Character string	Description
Judge	JG	Judgment results 0: No judgment (unmeasured) 1: Judgment result OK -1: Judgment result NG -10: Error (image format mismatch) -11: Error (unregistered model) -12: Error (insufficient memory) -20: Error (other errors)
Position X	X	X coordinate of the position where the circle is detected
Position Y	Y	Y coordinate of the position where the circle is detected
Ref. position X	SX	X coordinate of the reference position of the registered circle
Ref. position Y	SY	Y coordinate of the reference position of the registered circle
EC correlation value	CR	Evaluated value of circle detected
Radius	RA	Radius of circles detected
Count	CT	No. of the circles detected
Position N	XN	Detected circle N position X (N = 0 to 255)
Position N	YN	Detected circle N position Y (N = 0 to 255)
Evaluation N	CRN	Detected circle N circle evaluated value (N = 0 to 255)
Radius N	RAN	Detected circle N circle radius (N = 0 to 255)

2-6-10 External Reference Tables (EC Circle Search)

No.	Data name	Data ident	Set/Get	Data range
0	Judge	judge	Get only	0: No judgment (unmeasured), 1: Judgment result OK, -1: Judgment result NG, -10: Error (image format mismatch), -11: Error (unregistered model), -12: Error (insufficient memory), -20: Error (other errors)
5	Position X	positionX	Get only	-99,999.9999 to 99,999.9999
6	Position Y	positionY	Get only	-99,999.9999 to 99,999.9999
8	Reference coordinate X	referenceX	Get only	-99,999.9999 to 99,999.9999
9	Reference coordinate Y	referenceY	Get only	-99,999.9999 to 99,999.9999
15	Evaluation	evaluation	Get only	0 to 100
18	Radius	radius	Get only	0 to 99,999.9999

No.	Data name	Data ident	Set/Get	Data range
19	Count	searchCount	Get only	0 to 256
101	Output coordinates	outputCoordinate	Set/Get	0: After scroll, 1: Before scroll
102	Calibration	calibration	Set/Get	0: OFF, 1: ON
103	Reflect to overall judgement	overallJudge	Set/Get	0: ON, 1: OFF
140	Reference X	referencePosX	Set/Get	-99,999.9999 to 99,999.9999
141	Reference Y	referencePosY	Set/Get	-99,999.9999 to 99,999.9999
142	Circle brightness	ObjectVal	Set/Get	0: Black, 1:White, 2: Black and white
143	Edge color specification	colorSpecification	Set/Get	0: No, 1: Yes
144	Circle color R	colorObjR	Set/Get	0 to 255
145	Circle color G	colorObjG	Set/Get	0 to 255
146	Circle color B	colorObjB	Set/Get	0 to 255
147	Background color R	colorBakR	Set/Get	0 to 255
148	Background color G	colorBakG	Set/Get	0 to 255
149	Background color B	colorBakB	Set/Get	0 to 255
150	Mask size	maskSize	Set/Get	0: 3x3, 1: 5x5, 2: 7x7, 3: 9x9
151	Edge extraction level	edgeLowerLevel	Set/Get	0 to 255
153	Upper limit of position X	upperX	Set/Get	-99,999.9999 to 99,999.9999
154	Lower limit of position X	lowerX	Set/Get	-99,999.9999 to 99,999.9999
155	Upper limit of position Y	upperY	Set/Get	-99,999.9999 to 99,999.9999
156	Lower limit of position Y	lowerY	Set/Get	-99,999.9999 to 99,999.9999
159	Upper limit of evaluation	upperEvaluation	Set/Get	0 to 100
160	Lower limit of evaluation	lowerEvaluation	Set/Get	0 to 100
161	Upper limit of count	upperSearchNum	Set/Get	0 to 256
162	Lower limit of count	lowerSearchNum	Set/Get	0 to 256
165	Upper limit of radius	upperRadius	Set/Get	0 to 99,999.9999
166	Lower limit of radius	lowerRadius	Set/Get	0 to 99,999.9999
171	Search type	searchType	Set/Get	0: Single search 1: Multi search
172	Candidate Point Level	candidateLevel	Set/Get	0 to 100
173	Sort condition	sort	Set/Get	0: X ascending, 1: X descending, 2: Y ascending, 3: Y descending, 4: Eva. ascending, 5: Eva. descending, 6: Radius ascending, 7: Radius descending
174	Advanced setting	advancedSetting	Set/Get	0: OFF, 1: ON
176	Grouping distance	groupingDistance	Set/Get	1 to 10
177	Radius range	circleWidth	Set/Get	1 to 9,999

No.	Data name	Data ident	Set/Get	Data range
178	Radius	setRadius	Set/Get	1 to 9,999
179	Display Parameter	displayParameter	Set/Get	0 to 2
180	Sticking out circle isn't detected	outAreaRemove-Mode	Set/Get	0:OFF 1:ON
181	Setting unit of reference coordinate	refUnitNo	Set/Get	-1 to 9,999
182	Setting type of reference coordinate	refSettingType	Set/Get	0: Numerical, 1: Unit
183	Use point coordinate before scroll	beforeScrollRefMode	Set/Get	0: Not use, 1: Use
184	Reference X before scroll	beforeScrollRefPosX	Set/Get	-99,999.9999 to 99,999.9999
185	Reference Y before scroll	beforeScrollRefPosY	Set/Get	-99,999.9999 to 99,999.9999
1,000+N×4 (N=0 to 255)	Position X	X000 to X255	Get only	-99,999.9999 to 99,999.9999
1,001+N×4 (N=0 to 255)	Position Y	Y000 to Y255	Get only	-99,999.9999 to 99,999.9999
1,002+N×4 (N=0 to 255)	Evaluation	CR000 to CR255	Get only	0 to 100
1,003+N×4 (N=0 to 255)	Radius	RA000 to RA255	Get only	0 to 99,999.9999
6,002	Format	cameraColor	Set/Get	1: Monochrome camera 2: Color camera
91,000	figure0 Count	figArea0_count	Set/Get	1
91,001	figure0 Type	figArea0_fig0_type	Set/Get	8: Rectangle
91,002	figure0 mode	figArea0_fig0_mode	Set/Get	0: OR
91,014	figure0 Rectangle Upper left position X	figAr- ea0_fig0_box_X0	Set/Get	-99,999 to 99,999
91,015	figure0 Rectangle Upper left position Y	figAr- ea0_fig0_box_Y0	Set/Get	-99,999 to 99,999
91,016	figure0 Rectangle Lower right position X	figAr- ea0_fig0_box_X1	Set/Get	-99,999 to 99,999
91,017	figure0 Rectangle Lower right position Y	figAr- ea0_fig0_box_Y1	Set/Get	-99,999 to 99,999
91,099	figure0 Update	figArea0_update	Set only	1: Update

2-7 Shape Search II

This processing item is not available in the FHV series.

This function is for detecting user-defined target to estimate target position and pose precisely. The correlation value indicating the degree of similarity, measurement target position, and orientation can be output.

In shape search II, edge information is used as features, whereas in a normal search mode, color and texture information are used. It enables models to be detected fast, precisely, and robustly to environmental variations including shadings, reflections, lightings, shape deformations, pose and noises.

Used in the Following Case

Alignment mark detection and precise position estimation:

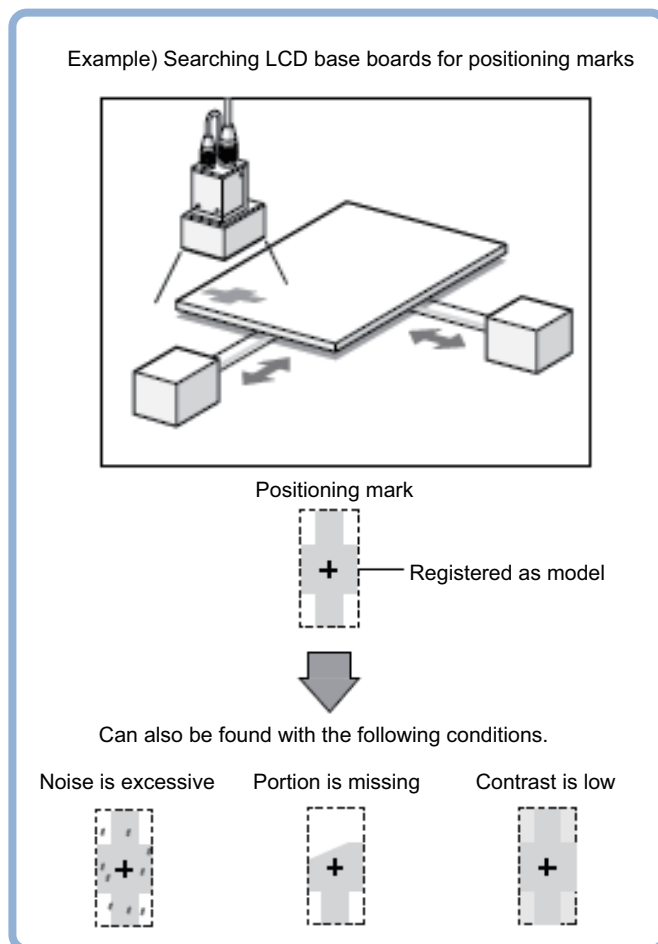

Precautions for Correct Use

Processing is different for color images and monochrome images. When the camera type used in the previous setup was changed to color or monochrome type, perform the settings again.



Additional Information

Search processing basic concepts

For details, refer to *Appendixes Measurement Mechanism Search Processing Mechanism in the Vision System FH/FHV Series User's Manual (Cat. No. Z365)*.

2-7-1 Settings Flow (Shape Search II)

To set Shape Search II, follow the steps below.

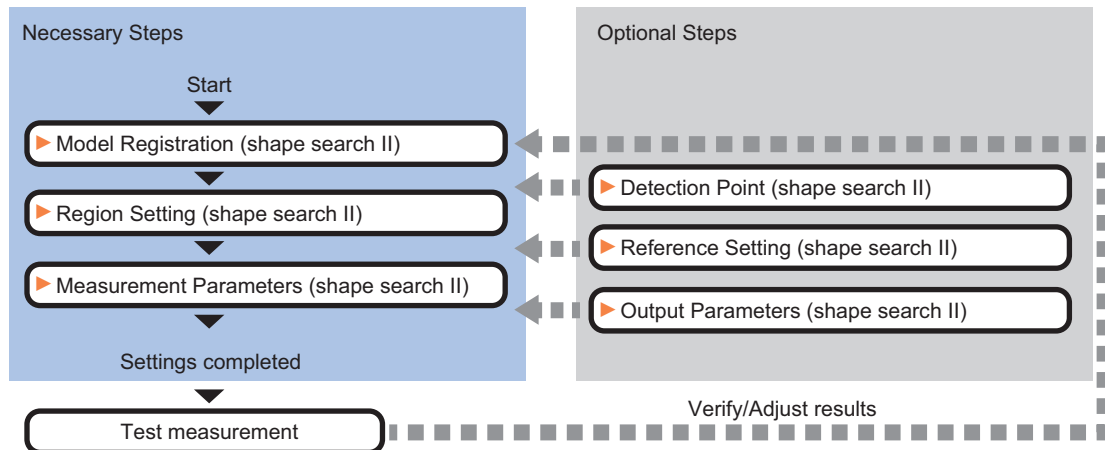

List of Shape Search II Items

Item	Description
Model	This item registers the pattern characteristic of the measurement image as a model. Change the model parameter (black and white reverse) as necessary. <i>2-7-2 Model Registration (Shape Search II) on page 2-98</i>
Region setting	Sets the measurement area. It is possible to target the entire screen, but restricting the range can shorten the processing time. <i>2-7-3 Region Setting (Shape Search II) on page 2-100</i>
Detection point	This item can be changed as necessary. Specify a position in the model that should be used as the detection coordinates during measurement. Usually, the central position of the set model is registered as the detection coordinates. <i>2-7-4 Detection Point (Shape Search II) on page 2-100</i>
Ref. setting	This item can be changed as necessary. Specify the reference position within the camera's field of view. <i>2-7-5 Reference Setting (Shape Search II) on page 2-101</i>
Measurement parameter	Sets processing conditions for measurement and judgment conditions for measurement results. Specify the criteria to judge the measurement result if the X and Y coordinates and the correlation with the model are OK. <i>2-7-6 Measurement Parameters (Shape Search II) on page 2-103</i>
Output parameter	This item can be changed as necessary. Normally, the factory default value will be used. Use the output parameter to specify how to handle the coordinates. <i>2-7-7 Output Parameters (Shape Search II) on page 2-105</i>

2-7-2 Model Registration (Shape Search II)

Register the parts to measure as the model.

The position at the time of registration is also registered in the model information. Place the measurement object in the correct position when registering a model.



Additional Information

When a model is registered, the central coordinates of the model are registered as the detection point. A detection point is a point output as a measurement value. If multiple figures are combined, the central coordinates of the circumscribed rectangle are registered.

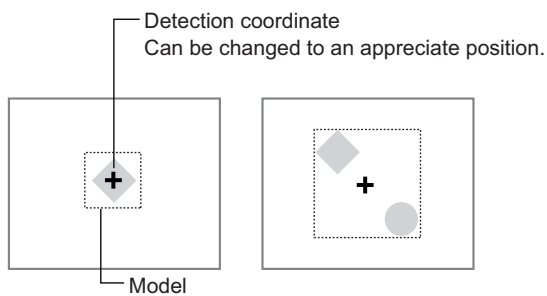

- 1** In the Item tab area, click **Model**.
When setting a new model, you do not have to click **Model**.
- 2** Use the drawing tools to specify the model registration range.
- 3** To save the entire image used for model registration, place a check at the *Save reg. model* option.

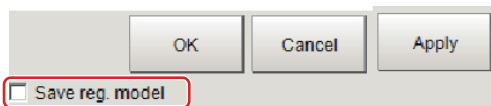

Additional Information

If you save the registered model image, you can re-register the model with the same image after model parameters are adjusted. Note that the scene data size increases when a registered model image is saved.

- 4** Click **OK** in the *Figure setting* area.
 - **OK**: Changes the settings and returns to the previous menu.
 - **Cancel**: Changes are discarded. Returns to the previous menu.
 - **Apply**: Updates the settings without leaving edit window.

Changing model parameters

If the light and dark of the background and the workpiece, such as a shiny workpiece, reverses, specify the *Reverse* setting as necessary.

After changing a setting, re-register the model.

- 1 Click **Detail setting**.



- 2 In the *Model parameter* area, set *Reverse*.

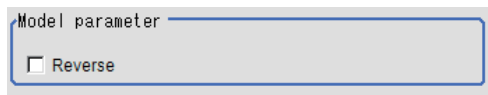

Setting item	Setting value [Factory default]	Description
Reverse	<ul style="list-style-type: none"> • Checked • [Unchecked] 	Specify whether to allow the reverse of light and dark for the model.

Displaying/Re-Registering/Deleting a Model

The buttons described in the following table are available when a model registration image is saved. You can use these buttons to reconfirm images used for model registration, or re-registering the model after adjusting detail settings.

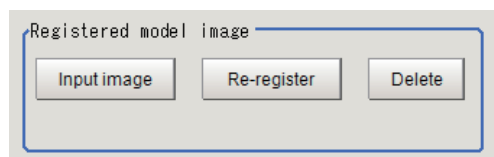

Setting item	Setting value	Description
Disp model/Input image	-	The model image display and input image display are switched.
Re-register	-	Re-registers a model using the model registration image. When model parameters are changed, you can display the model registration image and re-register. This button is available when the model registration image is displayed.
Delete	-	Deletes a model.

2-7-3 Region Setting (Shape Search II)

Use a rectangle to specify the area where the model is searched. Instead of measuring the entire input image, narrowing the measurement area shortens the processing time.

- 1** In the Item tab area, click **Region setting**.
- 2** Click **Edit**.
The *Figure Setting* area is displayed.
- 3** Specify the area in which to search for the model.
The rectangle covering the entire screen is set. Adjust the size and position of the rectangle.
- 4** Click **OK** in the *Figure setting* area.
 - **OK**: Changes the settings and returns to the previous menu.
 - **Cancel**: Changes are discarded. Returns to the previous menu.
 - **Apply**: Updates the settings without leaving edit window.

2-7-4 Detection Point (Shape Search II)

Specify a position in the model that should be used as the detection coordinates during measurement. Usually, the central position of the set model is registered as the detection point. This function is used to change to any desired position.

A detection point can be set either directly or by referencing a unit.



Additional Information

After changing the detection point coordinates to another position, re-registering the model will change it back to the center coordinates of the model.

Specifying directly

Click a position on the image you want to use as a detection point, or input coordinate data for that point.

- 1** In the Item tab area, click **Detection point**.
In the *Display* area, the current detection point is displayed with a crosshair cursor.



- 2** In the *Method* area, select *Numerical*.



- 3 Click the position to be set as the detection point.



Additional Information

Displaying the image enlarged makes this clicking easier.

For details, refer to *Appendix Basic Knowledge about Operations Using the Zoom Function in the Vision System FH/FHV Series User's Manual* (Cat. No. Z365).

- 4 Make fine adjustments using numeric value inputs or the arrow buttons as required.

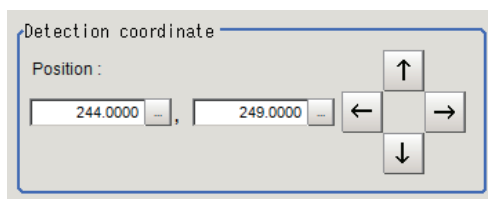

Referencing a unit

Set a detection point by referencing a detection point unit with registered X coordinate, Y coordinate and angle data.

- 1 In the Item tab area, click **Detection point**.
In the *Display* area, the current detection point is displayed with a crosshair cursor.
- 2 In the *Method* area, select *Unit*.

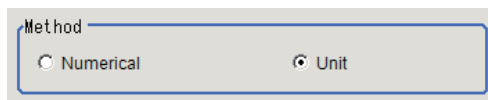

- 3 In the *Unit* area, select a detection point unit in the scene.

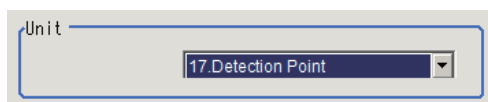

Performing the next measurement will display the detection point.

2-7-5 Reference Setting (Shape Search II)

When the model is set, this position is automatically set at the same time as the reference position. This item can be set to change the reference position to any desired position. This is handy for measuring the position deviation from a certain position.

A reference position can be set either directly or by referencing a unit.

Specifying Directly

Click a position on the image you want to use as a reference position, or input coordinate data for that point.

- 1 In the Item tab area, click **Ref. setting**.
In the *Display* area, the current reference position will be displayed as the crosshair cursor.



- 2 In the *Method* area, select *Numerical*.

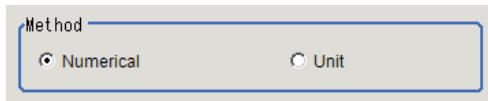

- 3 Click the position to be set as the reference.



Additional Information

Displaying the image enlarged makes this clicking easier.

For details, refer to *Appendixes Basic Knowledge about Operations Using the Zoom Function in the Vision System FH/FHV Series User's Manual* (Cat. No. Z365).

- 4 Make fine adjustments using numeric value inputs or the arrow buttons as required.

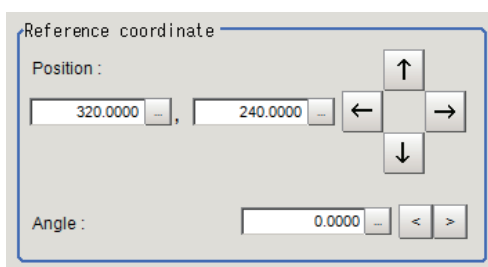

- 5 Set the reference angle with a numeric value.

- 6 To remeasure on the displayed image and set the reference, click **Measure ref.**.
To update the reference angle at the time of reference measurement, place a check at *Update the angle when measure ref.* .

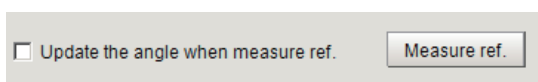

- 7** To use data before position compensation for the reference setting coordinates, place a check at *Use point coordinate before scroll*.

Use point coordinate before scroll

Position X: 320.0000

Position Y: 240.0000

Angle: 0.0000



Precautions for Correct Use

If you check *Use point coordinate before scroll*, do not use the following processing items. Otherwise, correct search results cannot be obtained.

- Precise Calibration
- Calibration Data Reference

Referencing a Unit

Set a reference by referencing a detection point unit with registered X coordinate, Y coordinate and angle data.

- 1** In the Item tab area, click **Ref. setting**.
In the *Display* area, the current reference position will be displayed as the crosshair cursor.
- 2** In the *Method* area, select *Unit*.

Method

Numerical Unit

- 3** In the *Unit* area, select a detection point unit in the scene.

Unit

17.Detection Point

Performing the next measurement will display the reference.

2-7-6 Measurement Parameters (Shape Search II)

Specify the measurement conditions and the judgment conditions for the measurement results of Search.

- 1** In the Item tab area, click **Measurement**.
- 2** In the *Measurement condition* area, specify a value for each item.

Setting item	Setting value [Factory default]	Description
Candidate LV	0 to 100 [50]	Specify the threshold value with which to detect candidate points in a rough search. Specify a smaller value when model search results are unreliable.
High-Prec.	<ul style="list-style-type: none"> • Checked • [Unchecked] 	<i>High-Prec.</i> mode enables sub-pixel and sub-degree order position and pose estimation. There is just a slight increase of processing time.
Rotation	<ul style="list-style-type: none"> • [Checked] • Unchecked 	Select the parameter when the target may be rotated and set appropriate range in <i>Angle range</i> .
Angle range	-180 to 180 [-180] to [180]	Specify the angle range when Rotation is checked.

When executing a multi search:

Setting item	Setting value [Factory default]	Description
Multiple output	<ul style="list-style-type: none"> • [Checked] • Unchecked 	Select to execute a multi-search.
Count	1 to 32 [32]	Specify the maximum number of detections.
Sort condition	<ul style="list-style-type: none"> • Corr. ascending • [Corr. descending] • X coordinate ascending • X coordinate descending • Y coordinate ascending • Y coordinate descending 	Specify the conditions by which the search number is re-assigned. When sorting referencing the X and Y coordinates, the upper left is the origin.
Search No.	0 to 31 [0]	Specify which of the multiple detection results will be used as measured results.

- When the setting has been changed, click **Measure** in the *Detail* area to verify whether measurements can be made correctly.

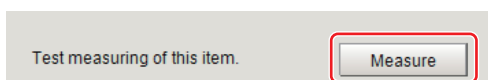

- Set up the judgment condition.

Setting item	Setting value	Description
Count	0 to 32	Specify the number of detections that are judged to be OK.
Position X	-99,999.9999 to 99,999.9999	Specify the range of X-axis shifting that is judged to be OK.
Position Y	-99,999.9999 to 99,999.9999	Specify the range of Y-axis shifting that is judged to be OK.
Angle θ	-180 to 180	Specify the range of angles that are judged to be OK.
Correlation	0 to 100 [60] to [1,000]	Specify the range of correlation values that are judged to be OK. However, when the correlation value of the measurement result is 0, the judgment result will be NG regardless of the lower limit setting.

2-7-7 Output Parameters (Shape Search II)

Specify how to treat the coordinates to be output to the external device as measurement results. This item can be changed if necessary. Normally, the factory default value will be used.



Precautions for Correct Use

After setting up the measurement parameters, changing the output parameters will cause measurement results to vary accordingly. If the output parameters have been changed, re-specify the measurement, too.

- 1 Click **Output parameter** in the Item tab area.
- 2 Specify each of the following items.

Setting item	Setting value [Factory default]	Description
Output coordinates	<ul style="list-style-type: none"> • [After scroll] • Before scroll 	As measurement results, select whether to output coordinate values to external devices before or after the position deflection correction is applied.
Calibration	<ul style="list-style-type: none"> • ON • [OFF] 	Select whether to reflect the calibration in the values output to the external device as measurement results. <ul style="list-style-type: none"> • ON: Output the coordinates converted into actual dimensions. • OFF: Output the camera coordinate values.
Reflect to overall judgment	<ul style="list-style-type: none"> • [ON] • OFF 	Enables choosing whether or not the judgement results of this processing unit is reflected in the scene overall judgment.



Additional Information

For output coordinates and calibration, refer to *Appendixes Measurement Mechanism Handling Coordinates* in the *Vision System FH/FHV Series User's Manual (Cat. No. Z365)*.

2-7-8 Key Points for Test Measurement and Adjustment (Shape Search II)

The following content is displayed in the *Detail result* area as text.



Precautions for Correct Use

Executing test measurements will update the measurement results and the figures in the image.

Displayed item	Description
Judge	Judgment results 0: No judgment (unmeasured) 1: Judgment result OK -1: Judgment result NG -10: Error (image format mismatch) -11: Error (unregistered model) -12: Error (insufficient memory) -20: Error (other errors)
Count	Count
Correlation	Correlation
Position X	X coordinate of the position where the model is detected.
Position Y	Y coordinate of the position where the model is detected.
Angle θ	Angle of the position where the model is detected.

The image specified in the Sub-image number in the image display setting is displayed in the *Image Display* area.

Sub-image number	Description of image to be displayed
0	Measurement image

Key Points for Adjustment (Shape Search II)

Adjust the setting parameters referring to the following points.

● When searching other positions

Parameter to be adjusted	Remedy
Measurement parameter	If the precision is low, check <i>High-Prec.</i>
	If images that should be judged OK vary greatly, specify a smaller value for <i>Candidate LV.</i>

● When the judgement is NG (insufficient memory)

Parameter to be adjusted	Remedy
Region setting	Make the search region as small as possible.

● When the processing speed is slow

Parameter to be adjusted	Remedy
Region setting	Make the search region as small as possible.
Model registration	Make the area to register as the model as small as possible.
Measurement parameter	If images that should be judged OK vary little, specify a larger value for <i>Candidate LV</i> .
	If the position precision is high, uncheck <i>High-Prec.</i>

2-7-9 Measurement Results for Which Output Is Possible (Shape Search II)

The following values can be output using processing items related to result output. It is also possible to reference measurement values from calculation expressions and other processing units.

Measurement items	Character string	Description
Judge	JG	Judgment results 0: No judgment (unmeasured) 1: Judgment result OK -1: Judgment result NG -10: Error (image format mismatch) -11: Error (unregistered model) -12: Error (insufficient memory) -20: Error (other errors)
Count	C	No. of models detected If none detected, 0
Correlation	CR	Correlation value with the model
Position X	X	X coordinate of the position where the model is detected.
Position Y	Y	Y coordinate of the position where the model is detected.
Angle θ	TH	Angle of the position where the model is detected.
Ref. position X	SX	X coordinate of the reference position of the registered model
Ref. position Y	SY	Y coordinate of the reference position of the registered model
Reference angle θ	ST	Reference angle of registered model
Detection point RX	RX	X coordinate of detection point set when model was registered
Detection point RY	RY	Y coordinate of detection point set when model was registered
Correlation value N (N = 00 to 31)	CRN	Detected search N correlation value (N = 00 to 31)
Position XN (N = 00 to 31)	XN	Detected search N position X (N = 00 to 31)
Position YN (N = 00 to 31)	YN	Detected search N position Y (N = 00 to 31)
Angle N (N = 00 to 31)	THN	Detected search N angle TH (N = 00 to 31)

2-7-10 External Reference Tables (Shape Search II)

No.	Data name	Data ident	Set/Get	Data range
0	Judge	judge	Get only	0: No judgment (unmeasured), 1: Judgment result OK, -1: Judgment result NG, -10: Error (image format mismatch), -11: Error (unregistered model), -12: Error (insufficient memory), -20: Error (other errors)
5	Correlation	correlation	Get only	0 to 100
6	Position X	positionX	Get only	-99,999.9999 to 99,999.9999
7	Position Y	positionY	Get only	-99,999.9999 to 99,999.9999
8	Angle	angle	Get only	-180 to 180
9	Reference positionX	referenceX	Get only	-99,999.9999 to 99,999.9999
10	Reference positionY	referenceY	Get only	-99,999.9999 to 99,999.9999
11	Reference angle	referenceAngle	Get only	-180 to 180
12	Detection pointX	detectionX	Get only	-99,999.9999 to 99,999.9999
13	Detection pointY	detectionY	Get only	-99,999.9999 to 99,999.9999
14	Count	count	Get only	0 to 32
101	Output coordinates	outputCoordinate	Set/Get	0: After scroll, 1: Before scroll
102	Calibration	calibration	Set/Get	0: OFF, 1: ON
103	Reflect to overall judgement	overallJudge	Set/Get	0: ON, 1: OFF
120	With rotation	rotation	Set/Get	0: OFF, 1: ON
121	Upper limit of the rotation angle	endAngle	Set/Get	-180.0000 to 180.0000
122	Lower limit of the rotation angle	startAngle	Set/Get	-180.0000 to 180.0000
124	Reverse	reverse	Set/Get	0: Not detect, 1: Detect
126	High-Prec.	subPixelMeas	Set/Get	0: OFF, 1: ON
127	Reference X	referencePosX	Set/Get	0 to 99,999.9999
128	Reference Y	referencePosY	Set/Get	0 to 99,999.9999
129	Reference angle	referencePosAngle	Set/Get	-180.0000 to 180.0000
133	Candidate Point Level	candidateLevel	Set/Get	0 to 100
134	Detected coordinate X	detectionPosX	Set/Get	0 to 99,999.9999
135	Detected coordinate Y	detectionPosY	Set/Get	0 to 99,999.9999
136	Sort condition	sort	Set/Get	0: Corr. ascending, 1: Corr. descending, 2: X ascending, 3: X descending, 4: Y ascending, 5: Y descending
137	Search No.	searchNo	Set/Get	0 to 31
138	Upper limit of the correlation	upperCorrelation	Set/Get	0.0000 to 100.0000
139	Lower limit of the correlation	lowerCorrelation	Set/Get	0.0000 to 100.0000

No.	Data name	Data ident	Set/Get	Data range
140	Upper limit of the detect number	upperCount	Set/Get	0 to 32
141	Lower limit of the detect number	lowerCount	Set/Get	0 to 32
142	Upper limit of the measurement coordinateX	upperX	Set/Get	-99,999.9999 to 99,999.9999
143	Lower limit of the measurement coordinateX	lowerX	Set/Get	-99,999.9999 to 99,999.9999
144	Upper limit of the measurement coordinateY	upperY	Set/Get	-99,999.9999 to 99,999.9999
145	Lower limit of the measurement coordinateY	lowerY	Set/Get	-99,999.9999 to 99,999.9999
146	Upper limit of the judge angle	upperAngle	Set/Get	-180.0000 to 180.0000
147	Lower limit of the judge angle	lowerAngle	Set/Get	-180.0000 to 180.0000
161	Max no. of detections	extractCount	Set/Get	1 to 32
168	Multiple output	isMulti	Set/Get	0: OFF, 1: ON
171	Save registered model	saveModelimage	Set/Get	0: OFF, 1: ON
231	Setting unit of reference coordinate	refUnitNo	Set/Get	-1 to 9,999
232	Setting type of reference coordinate	refSettingType	Set/Get	0: Numerical, 1: Unit
233	Update the reference angle	updateAngleFlg	Set/Get	0: Not update, 1: Update
234	Setting unit of detection coordinate	detUnitNo	Set/Get	-1 to 9,999
235	Setting type of detection coordinate	detSettingType	Set/Get	0: Numerical, 1: Unit
236	Use point coordinate before scroll	beforeScrollRefMode	Set/Get	0: Not use, 1: Use
237	Reference X before scroll	beforeScrollRefPosX	Set/Get	-99,999.9999 to 99,999.9999
238	Reference Y before scroll	beforeScrollRefPosY	Set/Get	-99,999.9999 to 99,999.9999
239	Angle before scroll	beforeScrollRefAngle	Set/Get	-180 to 180
1,000+N (N=0 to 31)	Correlation	correlation00 to correlation31	Get only	0 to 100
1,100+N (N=0 to 31)	Position X	positionX00 to positionX31	Get only	-99,999.9999 to 99,999.9999
1,200+N (N=0 to 31)	Position Y	positionY00 to positionY31	Get only	-99,999.9999 to 99,999.9999
1,300+N (N=0 to 31)	Angle	angle00 to angle31	Get only	-180 to 180
5,100	Re-register	UpdateUnitModel	Set only	1: Execute

No.	Data name	Data ident	Set/Get	Data range
6,002	Format	cameraColor	Set/Get	1: Monochrome camera 2: Color camera
91,000	figure0 Count	figArea0_count	Set/Get	1
91,001	figure0 Type	figArea0_fig0_type	Set/Get	8: Rectangle
91,002	figure0 mode	figArea0_fig0_mode	Set/Get	0: OR
91,014	figure0 Rectangle Upper left position X	figAr- ea0_fig0_box_X0	Set/Get	-99,999 to 99,999
91,015	figure0 Rectangle Upper left position Y	figAr- ea0_fig0_box_Y0	Set/Get	-99,999 to 99,999
91,016	figure0 Rectangle Lower right position X	figAr- ea0_fig0_box_X1	Set/Get	-99,999 to 99,999
91,017	figure0 Rectangle Lower right position Y	figAr- ea0_fig0_box_Y1	Set/Get	-99,999 to 99,999
91,099	figure0 Update	figArea0_update	Set only	1: Update

2-8 Shape Search III

This function registers a model of an image pattern based on its contour information and detect parts of inputted images that most closely match the model. The correlation value indicating the degree of similarity, measurement target position, and orientation can be measured.

In Shape Search III, contour information is used as features, whereas in a normal search mode, color and texture information are used.

It enables models to be detected fast, precisely, and robustly to environmental variations including shadings, reflections, lightings, shape deformations, pose and noises. Since state-of-the-art object detection algorithm is employed in Shape Search III, it can provide much more reliable position and pose estimation with higher speed compared to Shape Search II. Furthermore, it has much more parameter to tune to support a wider variety of applications.

Used in the Following Case

Alignment mark detection and precise position estimation:

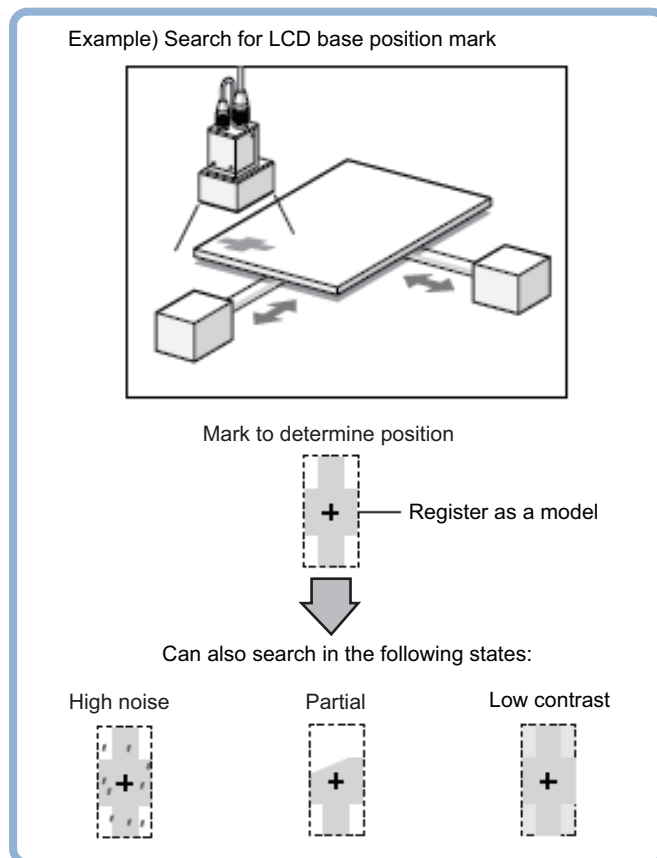

Precautions for Correct Use

- Processing is different for color images and monochrome images. When the camera type used in the previous setup was changed to color or monochrome type, perform the settings again.
- When the measurement region is changed, the Position X and Position Y can differ. Be sure to check functionality thoroughly before starting operation.



Additional Information

Search processing basic concepts

For details, refer to *Appendixes Measurement Mechanism Search Processing Mechanism in the Vision System FH/FHV Series User's Manual (Cat. No. Z365)*.

2-8-1 Settings Flow (Shape Search III)

To set Shape Search III, follow the steps below.

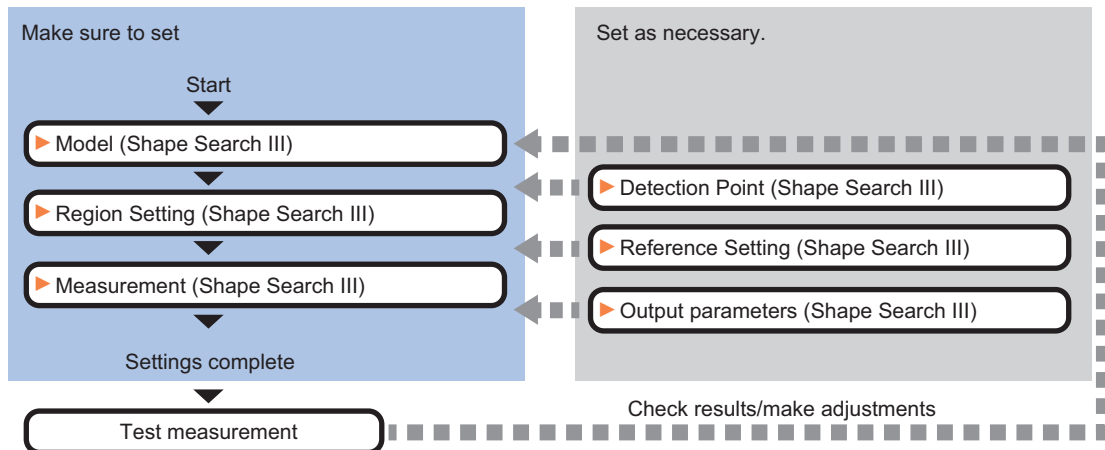

List of Shape Search III Items

Item	Description
Model	This item registers the pattern characteristic of the measurement image as a model. Model parameter values can be changed as needed to address unstable measurement results or to increase the processing speed. Normally, the factory default value will be used. <i>2-8-2 Model (Shape Search III) on page 2-113</i>
Region setting	Sets the measurement area. It is possible to target the entire screen, but restricting the range can shorten the processing time. <i>2-8-3 Region Setting (Shape Search III) on page 2-120</i>
Detection point	This item can be changed as necessary. Specify a position in the model that should be used as the detection coordinates during measurement. Usually, the central position of the set model is registered as the detection coordinates. <i>2-8-4 Detection Point (Shape Search III) on page 2-121</i>
Ref. setting	This item can be changed as necessary. Specify the reference position within the camera's field of view. <i>2-8-5 Reference Setting (Shape Search III) on page 2-122</i>
Measurement parameter	Sets processing conditions for measurement and judgment conditions for measurement results. Specify the criteria to judge the measurement result if the X and Y coordinates and the correlation with the model are OK. <i>2-8-6 Measurement parameter (Shape Search III) on page 2-124</i>
Output parameter	This item can be changed as necessary. Normally, the factory default value will be used. Use the output parameter to specify how to handle the coordinates. <i>2-8-7 Output Parameters (Shape Search III) on page 2-128</i>

2-8-2 Model (Shape Search III)

Register the characteristic parts of the image to measure as the Model.

Before registering as a Model, verify the workpiece position to detect. Position information entered at Model registration time is included in the Model information. If the position to detect at measurement time differs from the registered position, it will not be accurately detected.

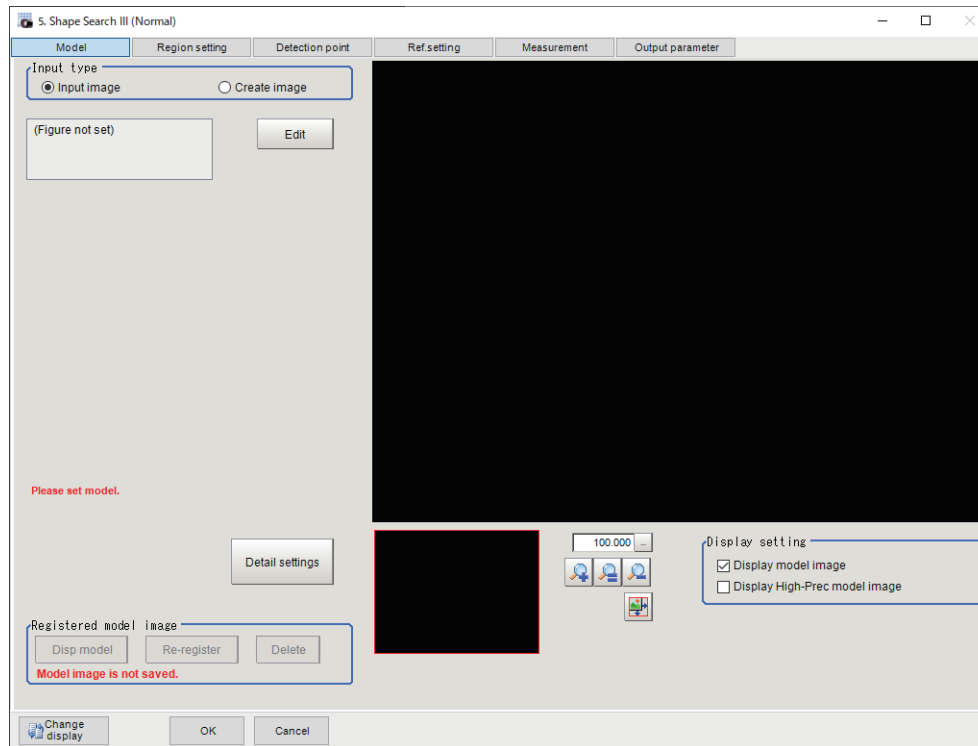

Model Registration

There are two methods for Model Registration. One is to use the input image. Another is to use an image from a previously provided graphic pattern. In most cases it is recommended to use the input image.

● Register the Model Image (Input Image)

Register the parts to measure as the model.

The position at the time of registration is also registered in the model information. Place the measurement object in the correct position when registering a model.



Additional Information

When a model is registered, the central coordinates of the model are registered as the detection point. A detection point is a point output as a measurement value. If multiple figures are combined, the central coordinates of the circumscribed rectangle are registered.

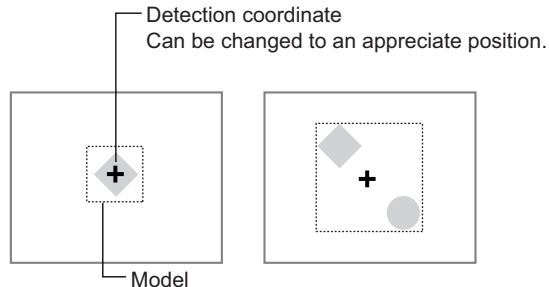

- 1 In the Item tab area, click **Model**.
- 2 Choose **Input image** in the *Input type* area.
- 3 Click **Edit**.
- 4 Use the drawing tools to specify the model registration range.



Precautions for Correct Use

Set the model size to less than $2,000 \times 2,000$.

- 5 To save the entire image used for model registration, place a check at the *Save reg. model* option.



Additional Information

If you save the registered model image, you can re-register the model with the same image after model parameters are adjusted. Note that the scene data size increases when a registered model image is saved.

- 6 Click **OK** in the *Figure setting* area.
 - **OK**: Changes the settings and returns to the previous menu.
 - **Cancel**: Changes are discarded. Returns to the previous menu.
 - **Apply**: Updates the settings without leaving edit window.
- **Registering a Model through Image Creating (Create Image)**

You can register a model using shapes provided in Shape Search III. Use this function when the captured image has excessive noise, or the shape in the image to register as the model is unclear, or is missing a part.

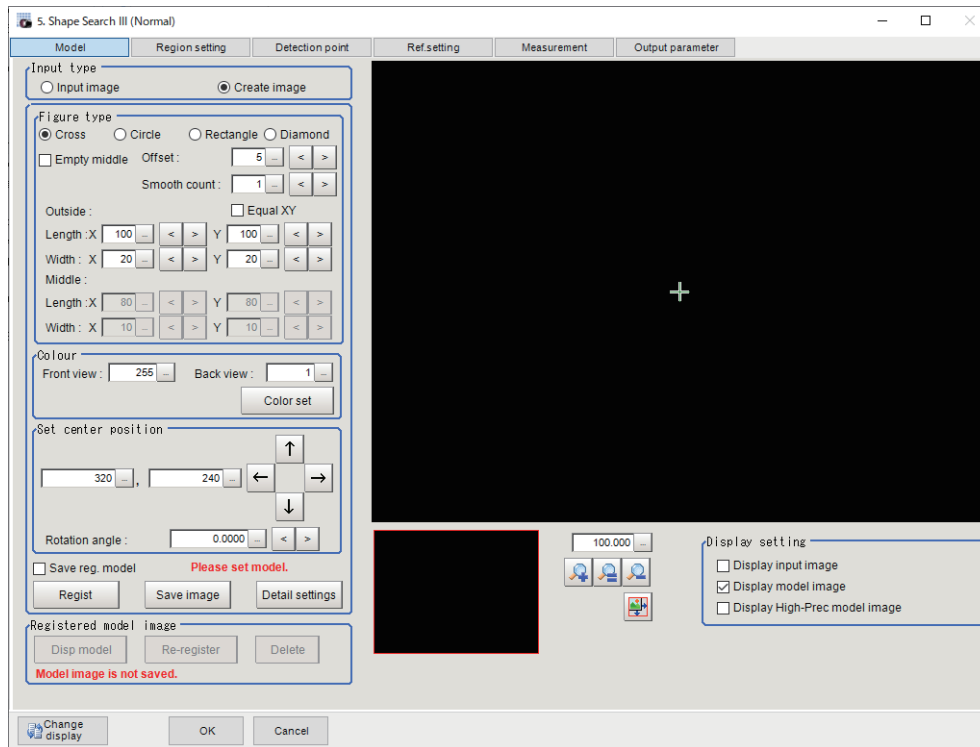

- 1 In the *Input type* area, select **Create image**.
- 2 Adjust each setting in the *Figure type* area.

Setting item	Setting value [Factory default]	Description
Figure type	<ul style="list-style-type: none"> • [Cross] • Circle • Rectangle • Diamond 	Selects the type of figure to be used for the created image model.
Empty middle	<ul style="list-style-type: none"> • Checked • [Unchecked] 	Selects whether or not to make the created image hollow. Select the setting according to the shape of the detection object.
Offset	0 to 99 [5]	Sets the margins from the outline of the shape used in the created image to the outline of the model registration region. Set a value that is larger than the smooth count. If you set a rotation angle, increase the value even more. Model registration will not be possible if the model region extends beyond the image. If that occurs, reduce the value.
Smooth count	0 to 9 [1]	Set the level of smoothing applied to the created figure according to the condition of the outline of the detection object. If the outline is clear, reduce the value. If the outline is not clear, increase the value.
Equal XY	<ul style="list-style-type: none"> • Checked • [Unchecked] 	If you place a check here, the length and width settings will become the same for X and Y.

Setting item	Setting value [Factory default]	Description
Outside <ul style="list-style-type: none"> • (Cross) Length X • (Cross) Length Y • (Cross) Width X • (Cross) Width Y • (Circle) Radius • (Rectangle) Length X • (Rectangle) Length Y • (Diamond) Length X • (Diamond) Length Y 	0 to 9,999 [100] [100] [20] [20] [50] [100] [50] [100] [50]	Specify the distance from the center to the outline of the shape to determine the size of the outline. Unit of measure: pixel When you specify the length X to 100, the total X direction of figure is 201 pixels: ±100 pixels from the center of figures.
Middle <ul style="list-style-type: none"> • (Cross) Length X • (Cross) Length Y • (Cross) Width X • (Cross) Width Y • (Circle) Radius • (Rectangle) Length X • (Rectangle) Length Y • (Diamond) Length X • (Diamond) Length Y 	0 to 9,999 [80] [80] [10] [10] [25] [50] [25] [50] [25]	Specify the distance from the center to the outline of the hollow to determine the size of the hollow. Unit of measure: pixel When you specify the length X to 100, the total X direction of figure is 201 pixels: ±100 pixels from the center of figures.

3 Click **Color set**.

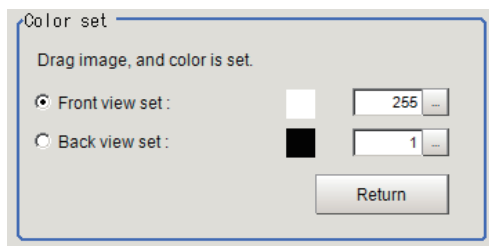

4 In the *Color set* area, specify colors of the created image.

Setting item	Setting value [Factory default]	Description
Color set	<ul style="list-style-type: none"> • [Front view set] • Back view set 	Sets the Front view or the Back view of the Create image. After the setting, drag a color part to be specified on the image. The color information of the dragged area will be set as the Front view or the Back view.

Setting item	Setting value [Factory default]	Description
Front view set	1 to 255 [255]	Sets the Front view color of the created image. Set it to match the foreground color of the actual detection object.
Back view set	1 to 255 [1]	Sets the Back view color of the created image. Set it to match the background color of the actual detection object.

- 5** Click **Return** in the *Color set* area.
- 6** On the image, click the position you want to use as the center coordinate of the shape.
- 7** Specify the position in detail by entering values or clicking arrows in the *Set center position* area.
- 8** Set *Rotation angle* by entering the value in the *Set center position* area.
- 9** Select the *Save reg. model* check box if you want to keep the image used for model registration for future reference.
- 10** Click **Save image** to save the created image.
- 11** Click **Regist**.
Model registration is finished successfully. If the *Save reg. model* check box is selected, the registered model image is also saved besides the model.

Adjusting Settings for Model Registration (Detail settings)

Adjust the settings by *Detail settings* when to stabilize measurements or speed up processing. Otherwise, keep the factory default settings. After adjustments, verify the settings by performing actual measurement.

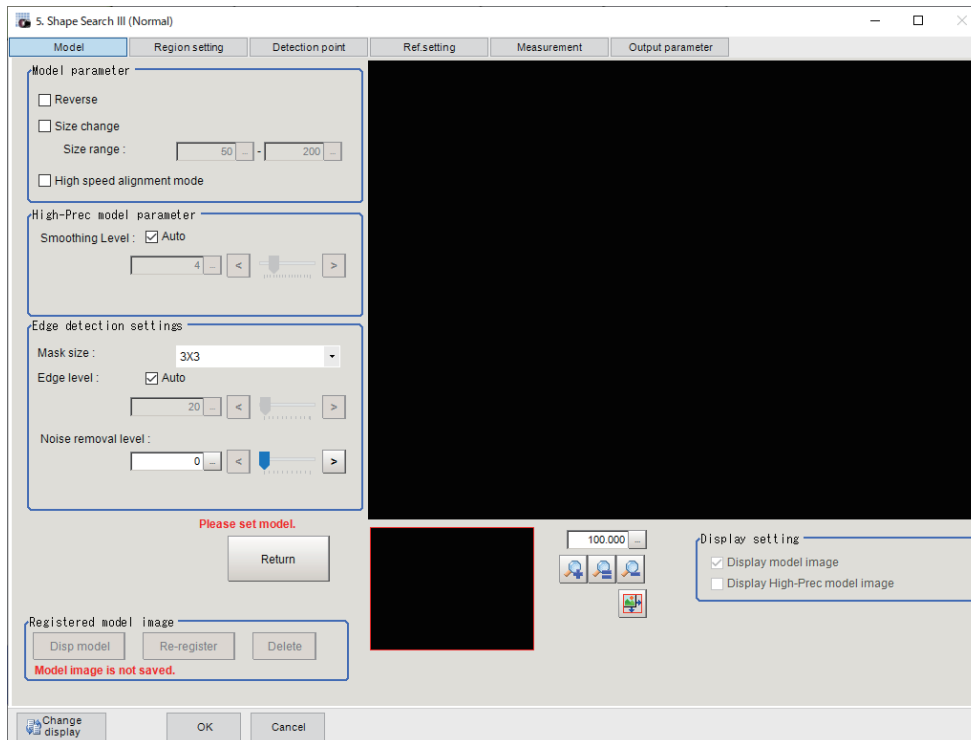

● Changing Model Parameters

Adjusting model parameters when to stabilize measurements or speed up processing. Re-register the model after the adjustment.

- 1 Click **Detail setting**.
- 2 Adjust each item in the *Model parameter area* and *High-Prec model parameter area*.

Setting item		Setting value [Factory default]	Description
Model parameter	Reverse	<ul style="list-style-type: none"> • Checked • [Unchecked] 	Select this check box when detecting objects whose dark areas and bright areas are fluctuating due to glossiness, etc.
	Size change	<ul style="list-style-type: none"> • Checked • [Unchecked] 	Select this check box when the size of target objects varies.
	Size range	50 to 200 [50] to [200]	This setting is available when the Size change check box is selected. Set the upper and lower limit of the size fluctuation.
	High speed alignment mode	<ul style="list-style-type: none"> • Checked • [Unchecked] 	Select this check box when detecting simple shapes such as alignment marks. Clear this check box when detecting complex patterns or shapes with only few pixel wide thin lines.

Setting item		Setting value [Factory default]	Description
High-Prec model parameter	Smoothing Level: Auto	<ul style="list-style-type: none"> • [Checked] • Unchecked 	Select this check box to automatically adjust the Smoothing level . If the result of the auto-adjustment is not as desired, clear this check box and adjust Smoothing level .
	Smoothing Level	1 to 16 [4]	This setting is available when the Smoothing Level: Auto check box is cleared. You can adjust the Smoothing Level of High-Prec model images used when the High-Prec. check box is selected in the Measurement Parameter tab page.



Additional Information

In *High speed alignment mode*, detection speed is faster, while maintaining accuracy and detection capability by simplifying the model and eliminating its complex feature information. This is effective especially when detecting simple shapes such as alignment marks.

● Changing the Edge Extraction Settings

Adjust the edge extraction settings when you cannot detect edges when registering a model, or when detected edges are broken. Re-register the model after the adjustment.

- 1 Click **Detail setting**.
- 2 Adjust each setting in the *Edge setting* area.

Setting item		Setting value [Factory default]	Description
Mask size	<ul style="list-style-type: none"> • [3x3] • 5x5 • 7x7 	Select the range of pixels which are used to extract the edge. With a larger <i>mask size</i> , search is less affected by variation in pixels.	
Edge level: Auto	<ul style="list-style-type: none"> • [Checked] • Unchecked 	Select this check box to adjust Edge level automatically. If edges are not detected under the auto settings, clear this check box and adjust value of Edge level .	
Edge level	0 to 1,024 [20]	This setting is enabled when the Auto check box is cleared in the <i>Edge detection settings</i> area. Set the lower limit of edge level to recognize as edge. Edges are recognized when their edge level is above this value. The smaller the value, the easier it is to find edges. The larger the value, the less noise will affect finding edges.	
Noise removal level	0 to 100 [0]	Specify the upper limit of noise level to eliminate. Noise whose noise level is below this value will be eliminated. In the noise removal process, edges are connected and divided into a set of groups of line segments, and then these line segments are removed one by one from shorter segments. Setting a larger value removes larger noise.	

● Verifying the Model on the Image (Display Settings)

When changing the display settings, the status of the registered model can be checked on the image.

- 1 In the *Display setting* area, adjust each setting.

Setting item	Setting value [Factory default]	Description
Display model image	<ul style="list-style-type: none"> • Checked • [Unchecked] 	This check box is available when the Create image check box is selected in the <i>Input type</i> area. Select this check box to check the captured image while also the created image is displayed.
Display input image	<ul style="list-style-type: none"> • [Checked] • Unchecked 	Select this check box to display and confirm the model image.
Display High-Prec model image	<ul style="list-style-type: none"> • Checked • [Unchecked] 	Select this check box to display the high precision model which is used when the High-Prec. check box is selected in the <i>Measurement</i> tab page.

- 2 Confirm the model image on display, and register as a model.

Displaying/Re-Registering/Deleting a Model

The buttons described in the following table are available when a model registration image is saved. You can use these buttons to reconfirm images used for model registration, or re-registering the model after adjusting detail settings.

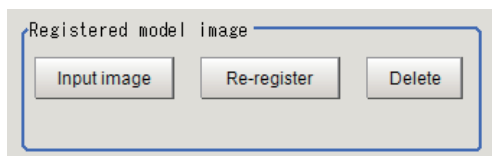

Setting item	Setting value	Description
Disp model/Input image	-	The model image display and input image display are switched.
Re-register	-	Re-registers a model using the model registration image. When model parameters are changed, you can display the model registration image and re-register. This button is available when the model registration image is displayed.
Delete	-	Deletes a model.

2-8-3 Region Setting (Shape Search III)

Use a rectangle to specify the area where the model is searched. Instead of measuring the entire input image, narrowing the measurement area shortens the processing time.

- 1 In the Item tab area, click **Region setting**.
- 2 Click **Edit**.
The *Figure Setting* area is displayed.
- 3 Specify the area in which to search for the model.
The rectangle covering the entire screen is set. Adjust the size and position of the rectangle.

- 4 Click **OK** in the *Figure setting* area.
 - **OK**: Changes the settings and returns to the previous menu.
 - **Cancel**: Changes are discarded. Returns to the previous menu.
 - **Apply**: Updates the settings without leaving edit window.

2-8-4 Detection Point (Shape Search III)

Specify a position in the model that should be used as the detection coordinates during measurement. Usually, the central position of the set model is registered as the detection point. This function is used to change to any desired position.

A detection point can be set either directly or by referencing a unit.



Additional Information

After changing the detection point coordinates to another position, re-registering the model will change it back to the center coordinates of the model.

Specifying directly

Click a position on the image you want to use as a detection point, or input coordinate data for that point.

- 1 In the *Item* tab area, click **Detection point**.
In the *Display* area, the current detection point is displayed with a crosshair cursor.



- 2 In the *Method* area, select *Numerical*.



- 3 Click the position to be set as the detection point.



Additional Information

Displaying the image enlarged makes this clicking easier.
For details, refer to *Appendixes Basic Knowledge about Operations Using the Zoom Function* in the *Vision System FH/FHV Series User's Manual* (Cat. No. Z365).

- 4 Make fine adjustments using numeric value inputs or the arrow buttons as required.

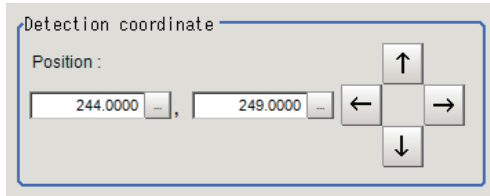

Referencing a unit

Set a detection point by referencing a detection point unit with registered X coordinate, Y coordinate and angle data.

- 1 In the Item tab area, click **Detection point**.
In the *Display* area, the current detection point is displayed with a crosshair cursor.
- 2 In the *Method* area, select *Unit*.

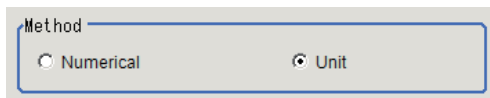

- 3 In the *Unit* area, select a detection point unit in the scene.

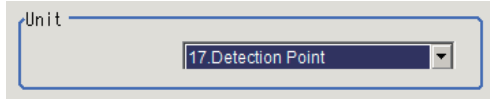

Performing the next measurement will display the detection point.

2-8-5 Reference Setting (Shape Search III)

When the model is set, this position is automatically set at the same time as the reference position. This item can be set to change the reference position to any desired position. This is handy for measuring the position deviation from a certain position.

A reference position can be set either directly or by referencing a unit.

Specifying Directly

Click a position on the image you want to use as a reference position, or input coordinate data for that point.

- 1 In the Item tab area, click **Ref. setting**.
In the *Display* area, the current reference position will be displayed as the crosshair cursor.



- 2 In the *Method* area, select *Numerical*.

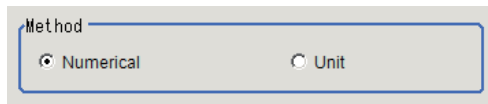

- 3 Click the position to be set as the reference.



Additional Information

Displaying the image enlarged makes this clicking easier.

For details, refer to *Appendixes Basic Knowledge about Operations Using the Zoom Function in the Vision System FH/FHV Series User's Manual (Cat. No. Z365)*.

- 4 Make fine adjustments using numeric value inputs or the arrow buttons as required.

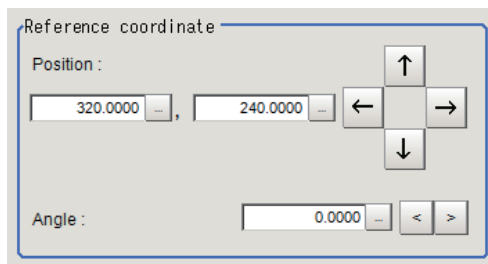

- 5 Set the reference angle with a numeric value.

- 6 To remeasure on the displayed image and set the reference, click **Measure ref.**.
To update the reference angle at the time of reference measurement, place a check at *Update the angle when measure ref.* .

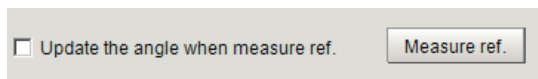

- 7 To use data before position compensation for the reference setting coordinates, place a check at *Use point coordinate before scroll*.

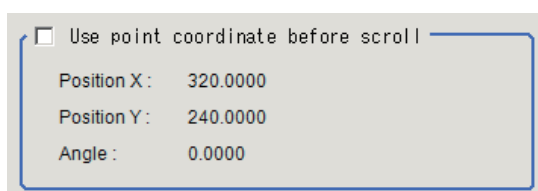



Precautions for Correct Use

If you check *Use point coordinate before scroll*, do not use the following processing items. Otherwise, correct search results cannot be obtained.

- Precise Calibration
- Calibration Data Reference

Referencing a Unit

Set a reference by referencing a detection point unit with registered X coordinate, Y coordinate and angle data.

- 1 In the Item tab area, click **Ref. setting**.
In the *Display* area, the current reference position will be displayed as the crosshair cursor.
- 2 In the *Method* area, select *Unit*.

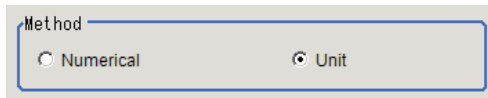

- 3 In the *Unit* area, select a detection point unit in the scene.

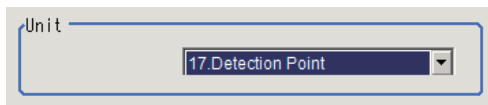

Performing the next measurement will display the reference.

2-8-6 Measurement parameter (Shape Search III)

Set the measurement conditions or judgment condition in this Measurement parameter.

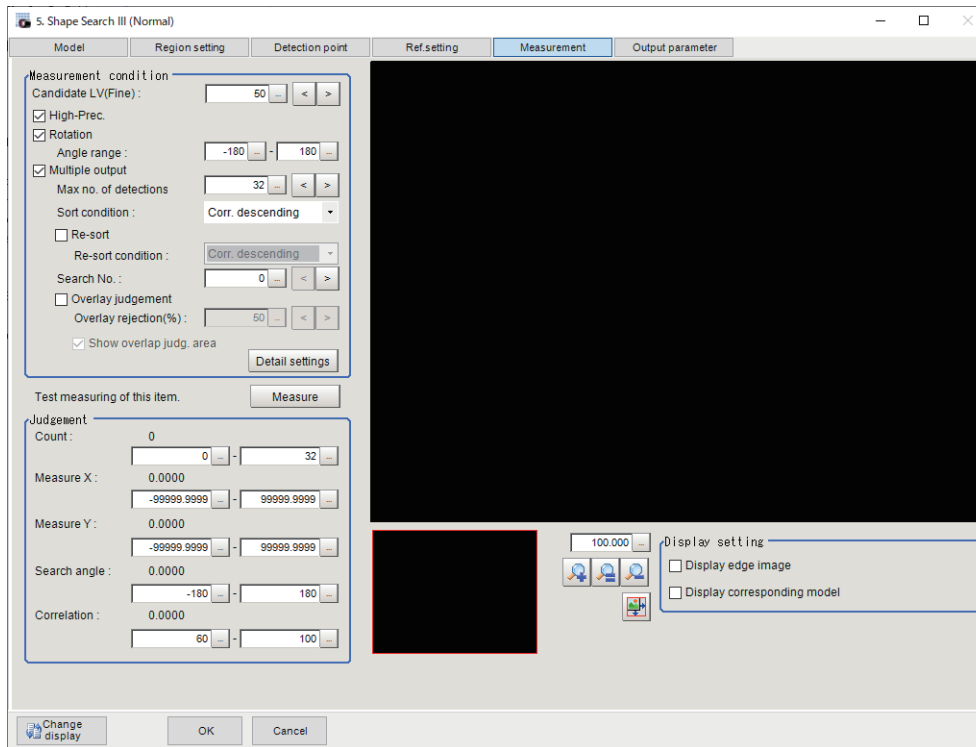

Setting the Measurement Conditions

Set the necessary parameters and processing conditions for the measurement.

- 1 In the Item tab area, click **Measurement**.
- 2 In the *Measurement condition* area, specify a value for each item.

Setting item	Setting value [Factory default]	Description
Candidate LV (Fine)	0 to 100 [50]	In detail search, searching is performed based on the information of candidate points detected by rough search. Results of a detail search become measurement results. Set the threshold when detecting candidate points with rough search. If variations in the appearance of the detection target are large or the variation tolerance for the workpiece is large, set it small. Conversely, if you want to exclude a pattern that is similar to the detection target, set it large.
High-Prec.	<ul style="list-style-type: none"> • [Checked] • Unchecked 	Check High-Prec. to measure more accurate position information. Note that the processing time will normally be faster if High-Prec. is left unchecked.
Rotation	<ul style="list-style-type: none"> • [Checked] • Unchecked 	Check this item when the direction differs of the inspection object differs from the registered model.
Angle range	-180 to 180 [-180] to [180]	Specify the angle range when Rotation is checked.
Multiple output	<ul style="list-style-type: none"> • Checked • [Unchecked] 	Check this item when you want to detect multiple objects in a single measurement.

Setting item	Setting value [Factory default]	Description
Max no. of detection	1 to 128 [32]	This function is applied when you check Multiple output . Sets the maximum number of detections. If more objects than the set value are detected, all detected candidates are sorted out. Then within Candidates from the top of counted number are output as the measurement result.
Sort condition	<ul style="list-style-type: none"> • Corr. ascending • [Corr. descending] • X ascending • X descending • Y ascending • Y descending 	This function is applied when you check Multiple output . Select this item to set for the Sort condition when Multiple output is executed. When sorting based on the X and Y coordinates, the upper left is the origin.
Re-sort	<ul style="list-style-type: none"> • Checked • [Unchecked] 	This function is applied when you check Multiple output . Check this item when you want to re-sort in other conditions. Only the result that selected in Count function are output.
Re-sort condition	<ul style="list-style-type: none"> • Corr. ascending • [Corr. descending] • X ascending • X descending • Y ascending • Y descending 	This function is applied when you check Multiple output . Select the Re-sort condition.
Search No.	0 to 127 [0]	This function is applied when you check Multiple output . Set the sort order number of output result from the sort or re-sort.
Overlay judgment	<ul style="list-style-type: none"> • Checked • [Unchecked] 	This function is applied when you check Multiple output . Check this item to distinguish the detected result from the overlap result.
Overlay rejection (%)	1 to 100 [50]	This function is applied when you check Overlay judgment . Adjust the overlap rejection percentage. Increase this value when you want to reject a small overlap.
Show overlap judg. area	<ul style="list-style-type: none"> • [Checked] • Unchecked 	This function is applied when you check Overlay judgment . When you check Show overlap judg , area, the area is displayed as dashed line.

3 Click **Detail setting** in the *Measurement condition* area to set value for each item.

Setting item	Setting value [Factory default]	Description
Edge level: Auto	<ul style="list-style-type: none"> • [Checked] • Unchecked 	Select this check box to adjust Edge level automatically. If edges are not detected under the auto settings, clear this check box and adjust value of Edge level .
Edge level	0 to 1,024 [30]	This setting is enabled when the Auto check box is cleared in the <i>Edge detection settings</i> area. Set the lower limit to recognize the Edge level . Edges are recognized when their edge level is above this value. The smaller the value, the easier it is to find edges. The larger the value, the less noise will affect finding edges.

Setting item	Setting value [Factory default]	Description
Acceptable distortion level	<ul style="list-style-type: none"> Low Medium [High] 	Selects the degree of influence of correlation values when Model edge has small uneven patterns. To avoid reduction of correlation value, set <i>High</i> in this item.
Back clutter	<ul style="list-style-type: none"> Checked [Unchecked] 	Check this item to get stable condition of measurement result when there are many edges in the background of Model.
Candidate LV Rough: Auto	<ul style="list-style-type: none"> [Checked] Unchecked 	Check this when automatically detecting candidate points in a rough search.
Candidate LV Rough	0 to 100 [50]	Rough search detects candidate points for detail search. This function is enabled when unchecking the checkbox for Candidate LV (Rough): Auto . Specify a smaller value when model search results are unreliable.

- 4** When the setting has been changed, click **Measure** in the *Detail* area to verify whether measurements can be made correctly.

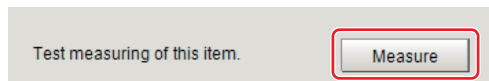

● Confirming the Measurement Result on the Display (Display Settings)

By changing the display setting, you can check the measurement processing status on the image.

- 1 Set the check box in the *Display setting* area.
- 2 Confirm the measurement processing condition, then set Measurement condition.

Setting item	Setting value [Factory default]	Description
Display edge image	<ul style="list-style-type: none"> Checked [Unchecked] 	Check this item when you confirm extracted edge set in Edge level on the display.
Display corresponding mode	<ul style="list-style-type: none"> Checked [Unchecked] 	<p>Check this item when you confirm target position detected in a rough search.</p> <p>Edge image for positions of the edge points of registered model is displayed in 3 colors (red, green, yellow).</p> <p>Green: Edge is on the measurement image, and its direction is same.</p> <p>Yellow: Edge is on the measurement image, but its direction is different. If direction is different, adjust it with Acceptable distortion level.</p> <p>Red: Edge is not on the measurement image. Adjust the parameters to reduce red indication as much as possible.</p>



Additional Information

In modes in which images are displayed by checking *Display edge image* or *Display corresponding model*, a message of memory insufficiency may appear if a high-resolution image is input.

Setting Judgment Condition

Set the upper and lower values to judge the measurement result. When the measurement result value is within the upper and lower values, Judgment is OK (pass). When the measurement result value exceeds either the upper or lower value Judgment is NG (failure). Although the judgment result for the processing Unit is OK when the judgment for all measurements is OK, it will be NG if any measurement result is NG.

- 1 Set the value in the *Judgment* area.

Setting item	Setting value [Factory default]	Description
Count	0 to 128 [0] to [32]	Sets the upper and lower values of number of Model to detect.
Measure X	-99,999.9999 to 99,999.9999 [-99,999.9999] to [99,999.9999]	Sets the upper and lower limit values on X coordinate for Model to detect.
Measure Y	-99,999.9999 to 99,999.9999 [-99,999.9999] to [99,999.9999]	Sets the upper and lower limit values on Y coordinate for Model to detect.
Search angle	-180 to 180 [-180] to [180]	Sets the upper and lower limit values for an angle of Model to detect.
Correlation	0 to 100 [60] to [100]	Sets the upper and lower limit values for the correlation to Model to detect. Judgment will be NG instead of the lower value when the measurement result correlation is zero.

2-8-7 Output Parameters (Shape Search III)

Specify how to treat the coordinates to be output to the external device as measurement results. This item can be changed if necessary. Normally, the factory default value will be used.



Precautions for Correct Use

After setting up the measurement parameters, changing the output parameters will cause measurement results to vary accordingly. If the output parameters have been changed, re-specify the measurement, too.

- 1 Click **Output parameter** in the Item tab area.
- 2 Specify each of the following items.

Setting item	Setting value [Factory default]	Description
Output coordinates	<ul style="list-style-type: none"> • [After scroll] • Before scroll 	As measurement results, select whether to output coordinate values to external devices before or after the position deflection correction is applied.

Setting item	Setting value [Factory default]	Description
Calibration	<ul style="list-style-type: none"> • ON • [OFF] 	Select whether to reflect the calibration in the values output to the external device as measurement results. <ul style="list-style-type: none"> • ON: Output the coordinates converted into actual dimensions. • OFF: Output the camera coordinate values.
Reflect to overall judgment	<ul style="list-style-type: none"> • [ON] • OFF 	Enables choosing whether or not the judgement results of this processing unit is reflected in the scene overall judgment.



Additional Information

For output coordinates and calibration, refer to *Appendixes Measurement Mechanism Handling Coordinates* in the *Vision System FH/FHV Series User's Manual (Cat. No. Z365)*.

2-8-8 Key Points for Test Measurement and Adjustment (Shape Search III)

The following content is displayed in the *Detail result* area as text.



Precautions for Correct Use

When performing a test measurement, the detailed information and image displayed will be updated according to the measurement result.

Displayed item	Description
Judge	Judgment results 0: No judgment (unmeasured) 1: Judgment result OK -1: Judgment result NG -10: Error (image format mismatch) -11: Error (unregistered model) -12: Error (insufficient memory) -20: Error (other errors)
Count	Count
Correlation	Correlation
Position X	X coordinate of the position where the model is detected.
Position Y	Y coordinate of the position where the model is detected.
Angle θ	Angle of the position where the model is detected.

The image specified in the Sub-image number in the image display setting is displayed in the *Image Display* area.

Sub-image number	Description of image to be displayed
0	Measurement image
1	Measurement image with detection results overlaid.
2	Edge image
3	Edge image with detection results overlaid. Green: Matched model points Yellow: Model points matched but with different directions Red: Unmatched model points

Key Points for Adjustment (Shape Search III)

Adjust the setting parameters referring to the following points.

● When the processing speed is slow

Parameter to be adjusted	Remedy
Region setting	The measurement processing time might take longer because the measurement region is broad. Set the measurement region as narrow as possible.
Model registration	The measurement processing time might take longer because the model region is broad. Set the model region as narrow as possible. A complicated shape might be registered as a model. Check the <i>High-speed alignment mode</i> in the <i>Model</i> tab when the target pattern is not a complex.
Measurement parameter	Detection targets might be found excessively in Rough-Search. Raise <i>Rough-Search detection level</i> when the variation in non-defective workpieces is small. The processing time for the high precision measurement might have taken longer than that for the sub-pixel one. Uncheck the <i>High-Prec.</i> when the position accuracy is sufficient. A needless angle measurement might have been performed to rotational symmetric workpieces such as circular shapes. Uncheck <i>Rotation</i> in this case. Rotational symmetric workpieces with a narrow angle measurement range such as square might have been measured with a large angle range. Narrow the <i>Angle range</i> when detecting point symmetric workpieces.

● In the Case of Searching Other Position

Parameter to be adjusted	Remedy
Measurement parameter	Detection targets might be found excessively by Rough-Search. Raise <i>Rough-Search detection level</i> when a place where there is no workpiece or features similar to the workpiece is misdetecting. Due to many edges in the workpiece background, there is a possibility that the edges of the detection targets may be not correctly identified and have been falsely detected. Check the <i>Extended detection candidate</i> when many edges are in the background.

● When the Judgment Result is NG (Insufficient Memory)

Parameter to be adjusted	Remedy
Region setting	Memory consumption might have been too high due to a large measurement region. Narrow the measurement region as much as possible.
Model registration	Memory might have been consumed a lot due to a large model size. Set the registration area for a model as narrow as possible or narrow the range between upper and lower limit of the <i>Size range (%)</i> by checking the <i>Size change</i> .
Measurement parameter	Memory might have been consumed a lot with images having many edges due to the <i>Extended detection candidate</i> checked. Uncheck the <i>Extended detection candidate</i> and filter the background edges using processing items in <i>Compensate image</i> beforehand.

● When the Measurement Results are Unstable

Parameter to be adjusted	Remedy
Measurement parameter	Variation for non-defective workpieces might be large. Decrease the <i>Rough-Search detection level</i> .
	The individual difference among workpiece shapes might be large. Increase the <i>Acceptable distortion level</i> when the correlation value decreases greatly when changing workpieces.
	Fine edges other than workpiece shapes might also be detected. Raise the <i>Edge Level (Measure)</i> when dirt or patterns of workpieces are also misdected.
	Measurement in the pixel unit might not be performed. Check the <i>High-Prec.</i> when the measurement accuracy is low.

2-8-9 Measurement Results for Which Output is Possible (Shape Search III)

The following values can be output using processing items related to result output. It is also possible to reference measurement values from calculation expressions and other processing units.

Measurement items	Character string	Description
Judge	JG	Judgment results 0: No judgment (unmeasured) 1: Judgment result OK -1: Judgment result NG -10: Error (image format mismatch) -11: Error (unregistered model) -12: Error (insufficient memory) -20: Error (other errors)
Count	C	No. of models detected If none detected, 0
Correlation	CR	Correlation value with the model
Position X	X	X coordinate of the position where the model is detected.
Position Y	Y	Y coordinate of the position where the model is detected.
Angle θ	TH	Angle of the position where the model is detected.
Ref. position X	SX	X coordinate of the reference position of the registered model
Ref. position Y	SY	Y coordinate of the reference position of the registered model
Reference angle θ	ST	Reference angle of registered model
Detection point RX	RX	X coordinate of detection point set when model was registered
Detection point RY	RY	Y coordinate of detection point set when model was registered
Correlation value N (N = 00 to 127)	CRN	Detected search N correlation value (N = 00 to 127)
Position XN (N = 00 to 127)	XN	Detected search N position X (N = 00 to 127)
Position YN (N = 00 to 127)	YN	Detected search N position Y (N = 00 to 127)
Angle N (N = 00 to 127)	THN	Detected search N angle TH (N = 00 to 127)

2-8-10 External Reference Tables (Shape Search III)

No.	Data name	Data ident	Set/Get	Data range
0	Judge	judge	Get only	0: No judgment (unmeasured), 1: Judgment result OK, -1: Judgment result NG, -10: Error (image format mismatch), -11: Error (unregistered model), -12: Error (insufficient memory), -20: Error (other errors)
5	Correlation	correlation	Get only	0.0000 to 100.0000
6	Position X	positionX	Get only	-99,999.9999 to 99,999.9999
7	Position Y	positionY	Get only	-99,999.9999 to 99,999.9999
8	Angle	angle	Get only	-180.0000 to +180.0000
9 ^{*1}	Reference positionX	referenceX	Get only	-99,999.9999 to 99,999.9999
10 ^{*1}	Reference positionY	referenceY	Get only	-99,999.9999 to 99,999.9999
11	Reference angle	referenceAngle	Get only	-180.0000 to +180.0000
12	Detection pointX	detectionX	Get only	-99,999.9999 to 99,999.9999
13	Detection pointY	detectionY	Get only	-99,999.9999 to 99,999.9999
14	Count	count	Get only	0 to 128
101	Output coordinates	outputCoordinate	Set/Get	0: After scroll, 1: Before scroll
102	Calibration	calibration	Set/Get	0: OFF, 1: ON
103	Reflect to overall judgement	overallJudge	Set/Get	0: ON, 1: OFF
120	With rotation	rotation	Set/Get	0: OFF, 1: ON
121	Upper limit of the rotation angle	endAngle	Set/Get	-180 to 180
122	Lower limit of the rotation angle	startAngle	Set/Get	-180 to 180
123	Edge level (Model)	edgeLevelModel	Set/Get	0 to 1,024
124	Reverse	reverse	Set/Get	0: Not detect, 1: Detect
126	High-Prec.	subPixelMeas	Set/Get	0: OFF, 1: ON
127 ^{*2}	Reference X	referencePosX	Set/Get	0 to 99,999.9999
128 ^{*2}	Reference Y	referencePosY	Set/Get	0 to 99,999.9999
129	Reference angle	referencePosAngle	Set/Get	-180.0 to 180.0
130	Size change	changeSize	Set/Get	0: OFF, 1: ON
131	Upper limit of the size range	upperChangeSize	Set/Get	50 to 200
132	Lower limit of the size range	lowerChangeSize	Set/Get	50 to 200
133	Candidate Point Level(Fine)	candidateLevel	Set/Get	0 to 100
134	Detected coordinate X	detectionPosX	Set/Get	0 to 99,999.9999
135	Detected coordinate Y	detectionPosY	Set/Get	0 to 99,999.9999

No.	Data name	Data ident	Set/Get	Data range
136	Sort condition	sort	Set/Get	0: Corr. ascending, 1: Corr. descending, 2: X ascending, 3: X descending, 4: Y ascending, 5: Y descending
137	Search No.	searchNo	Set/Get	0 to 127
138	Upper limit of the correlation	upperCorrelation	Set/Get	0 to 100
139	Lower limit of the correlation	lowerCorrelation	Set/Get	0 to 100
140	Upper limit of the detect number	upperCount	Set/Get	0 to 128
141	Lower limit of the detect number	lowerCount	Set/Get	0 to 128
142	Upper limit of the measurement coordinateX	upperX	Set/Get	-99,999.9999 to 99,999.9999
143	Lower limit of the measurement coordinateX	lowerX	Set/Get	-99,999.9999 to 99,999.9999
144	Upper limit of the measurement coordinateY	upperY	Set/Get	-99,999.9999 to 99,999.9999
145	Lower limit of the measurement coordinateY	lowerY	Set/Get	-99,999.9999 to 99,999.9999
146	Upper limit of the judge angle	upperAngle	Set/Get	-180 to 180
147	Lower limit of the judge angle	lowerAngle	Set/Get	-180 to 180
150	Edge level (Measure)	edgeLevelMeas	Set/Get	0 to 1,024
161	Max no. of detection	extractCount	Set/Get	1 to 128
168	Multiple output	isMulti	Set/Get	0: OFF, 1: ON
171	Save registered model	saveModelimage	Set/Get	0: OFF, 1: ON
172	Edge level (Measure) auto setting	edgeLevelMeasAuto	Set/Get	0: OFF, 1: ON
173	High speed alignment mode	highSpeedMode	Set/Get	0: OFF, 1: ON
174	Mask size	maskSize	Set/Get	0: 3×3, 1: 5×5, 2: 7×7
177	High precision level	subPixelLevel	Set/Get	1 to 16
178	Edge level (Model) auto setting	edgeLevelModelAuto	Set/Get	0: OFF, 1: ON
180	Acceptable distortion level	distLevel	Set/Get	0: Low, 1: Middle, 2: High
181	Noise removal level	edgeLengthLevel	Set/Get	0 to 100
182	High precision level auto setting	subPixelLevelAuto	Set/Get	0: OFF, 1: ON
183	Back clutter	complexBackGround	Set/Get	0: OFF, 1: ON

No.	Data name	Data ident	Set/Get	Data range
184	Candidate Point Level(Rough)	candidateLevel-Rough	Set/Get	0 to 100
185	Candidate Point Level(Rough) auto setting	candidateLevel-RoughAuto	Set/Get	0: OFF, 1: ON
201	Input type	inputType	Set/Get	0: Input image, 1: Create image
202	Figure type	graphicType	Set/Get	0: Cross, 1: Circle, 2: Rectangle, 3: Diamond
203	Empty middle	midEmpty	Set/Get	0: OFF, 1: ON
204	Offset	offset	Set/Get	0 to 99
205	Smooth count	smoothCount	Set/Get	0 to 9
206	Equal XY	equalXY	Set/Get	0: OFF, 1: ON
207	Front view value	frontViewValue	Set/Get	1 to 255
208	Back view value	backViewValue	Set/Get	1 to 255
209	Display input image	showInputImage	Set/Get	0: OFF, 1: ON
210	Cross's outside length X	crossOutLenX	Set/Get	0 to 9,999
211	Cross's outside length Y	crossOutLenY	Set/Get	0 to 9,999
212	Cross's outside width X	crossOutWidX	Set/Get	0 to 9,999
213	Cross's outside width Y	crossOutWidY	Set/Get	0 to 9,999
214	Cross's inside length X	crossMidLenX	Set/Get	0 to 9,999
215	Cross's inside length Y	crossMidLenY	Set/Get	0 to 9,999
216	Cross's inside width X	crossMidWidX	Set/Get	0 to 9,999
217	Cross's inside width Y	crossMidWidY	Set/Get	0 to 9,999
218	Circle's outside radius	circleOutRadius	Set/Get	0 to 9,999
219	Circle's inside radius	circleMidRadius	Set/Get	0 to 9,999
220	Rectangle's outside length X	rectangleOutLenX	Set/Get	0 to 9,999
221	Rectangle's outside length Y	rectangleOutLenY	Set/Get	0 to 9,999
222	Rectangle's inside length X	rectangleMidLenX	Set/Get	0 to 9,999
223	Rectangle's inside length Y	rectangleMidLenY	Set/Get	0 to 9,999
224	Center position X	midPositionX	Set/Get	0 to 99,999
225	Center position Y	midPositionY	Set/Get	0 to 99,999
227	Re-sort	isReSort	Set/Get	0: OFF, 1: ON
228	Re-sort condition	reSortCondition	Set/Get	0: Corr. ascending, 1: Corr. descending, 2: X ascending, 3: X descending, 4: Y ascending, 5: Y descending

No.	Data name	Data ident	Set/Get	Data range
229	Overlay judgement	checkOverlayArea	Set/Get	0: OFF, 1: ON
230	Overlay permission	overlayAreaPer	Set/Get	1 to 100
231	Setting unit of reference coordinate	refUnitNo	Set/Get	-1 to 9,999
232	Setting type of reference coordinate	refSettingType	Set/Get	0: Numerical, 1: Unit
233	Update the reference angle	updateAngleFlg	Set/Get	0: Not update, 1: Update
234	Setting unit of detection coordinate	detUnitNo	Set/Get	-1 to 9,999
235	Setting type of detection coordinate	detSettingType	Set/Get	0: Numerical, 1: Unit
236	Use point coordinate before scroll	beforeScrollRefMode	Set/Get	0: Not use, 1: Use
237	Reference X before scroll	beforeScrollRefPosX	Set/Get	-99,999.9999 to 99,999.9999
238	Reference Y before scroll	beforeScrollRefPosY	Set/Get	-99,999.9999 to 99,999.9999
239	Angle before scroll	beforeScrollRefAngle	Set/Get	-180 to 180
240	Rotation angle	turnAngle	Set/Get	-180.0000 to 180.0000
241	Diamond's outside length X	diamondOutLenX	Set/Get	0 to 9,999
242	Diamond's outside length Y	diamondOutLenY	Set/Get	0 to 9,999
243	Diamond's inside length X	diamondMidLenX	Set/Get	0 to 9,999
244	Diamond's inside length Y	diamondMidLenY	Set/Get	0 to 9,999
245	Display model image	searchModelImage	Set/Get	0: OFF, 1: ON
246	Display High-Prec model image	searchSubModelImage	Set/Get	0: OFF, 1: ON
249	Show overlap judg. area	dispOverlayArea	Set/Get	0: OFF, 1: ON
2,000	Additional correction flag of the position XY	coordinateCorrectionFlag	Set/Get	0: Old algorithm (Ver. 5.60 or earlier), 1: New algorithm (Ver. 5.70 or later)
5,100	Re-register	UpdateUnitModel	Set only	1: Execute
6,002	Format	cameraColor	Set/Get	1: Monochrome camera 2: Color camera
30,000+N (N=0 to 127)	Correlation	correlation000 to correlation127	Get only	0.0000 to 100.0000
40,000+N (N=0 to 127)	Position X	positionX000 to positionX127	Get only	-99,999.9999 to 99,999.9999
50,000+N (N=0 to 127)	Position Y	positionY000 to positionY127	Get only	-99,999.9999 to 99,999.9999
60,000+N (N=0 to 127)	Angle	angle000 to angle127	Get only	-180.0000 to +180.0000
91,000	figure0 Count	figArea0_count	Set/Get	1 to 8
91,001	figure0 Type	figArea0_fig0_type	Set/Get	8: Rectangle, 16: Ellipse, 64: Circumference, 512: Polygon

No.	Data name	Data ident	Set/Get	Data range
91,002	figure0 mode	figArea0_fig0_mode	Set/Get	0: OR, 1: NOT
91,014	figure0 Rectangle Upper left position X	figAr- ea0_fig0_box_X0	Set/Get	-99,999 to 99,999
91,015	figure0 Rectangle Upper left position Y	figAr- ea0_fig0_box_Y0	Set/Get	-99,999 to 99,999
91,016	figure0 Rectangle Lower right position X	figAr- ea0_fig0_box_X1	Set/Get	-99,999 to 99,999
91,017	figure0 Rectangle Lower right position Y	figAr- ea0_fig0_box_Y1	Set/Get	-99,999 to 99,999
91,018	figure0 Ellipse Cen- ter Position X	figArea0_fig0_el- lipse_CX	Set/Get	-99,999 to 99,999
91,019	figure0 Ellipse Cen- ter Position Y	figArea0_fig0_el- lipse_CY	Set/Get	-99,999 to 99,999
91,020	figure0 Ellipse Radi- usX	figArea0_fig0_el- lipse_RX	Set/Get	1 to 99,999
91,021	figure0 Ellipse Radi- usY	figArea0_fig0_el- lipse_RY	Set/Get	1 to 99,999
91,025	figure0 Circumfer- ence Center Position X	figArea0_fig0_cir- cleW_X	Set/Get	-99,999 to 99,999
91,026	figure0 Circumfer- ence Center Position Y	figArea0_fig0_cir- cleW_Y	Set/Get	-99,999 to 99,999
91,027	figure0 Circumfer- ence Radius	figArea0_fig0_cir- cleW_R	Set/Get	0 to 99,999
91,028	figure0 Circumfer- ence Width	figArea0_fig0_cir- cleW_W	Set/Get	0 to 99,999
91,040	figure0 Polygon Point Count	figArea0_fig0_poly- gon_count	Set/Get	3 to 10
91,041	figure0 Polygon Point0 Position X	figArea0_fig0_poly- gon_x0	Set/Get	-99,999 to 99,999
91,042	figure0 Polygon Point0 Position Y	figArea0_fig0_poly- gon_y0	Set/Get	-99,999 to 99,999
:	:	:	:	:
91,059	figure0 Polygon Point10 Position X	figArea0_fig0_poly- gon_x9	Set/Get	-99,999 to 99,999
91,060	figure0 Polygon Point10 Position Y	figArea0_fig0_poly- gon_y9	Set/Get	-99,999 to 99,999
91,099	figure0 Update	figArea0_update	Set only	1:Update
91,101	figure1 Type	figArea0_fig1_type	Set/Get	8: Rectangle, 16: Ellipse, 64: Circumference, 512: Polygon
:	:	:	:	:
91,201	figure2 Type	figArea0_fig2_type	Set/Get	8: Rectangle, 16: Ellipse, 64: Circumference, 512: Polygon
:	:	:	:	:
91,301	figure3 Type	figArea0_fig3_type	Set/Get	8: Rectangle, 16: Ellipse, 64: Circumference, 512: Polygon
:	:	:	:	:

No.	Data name	Data ident	Set/Get	Data range
91,401	figure4 Type	figArea0_fig4_type	Set/Get	8: Rectangle, 16: Ellipse, 64: Circumference, 512: Polygon
:	:	:	:	:
91,501	figure5 Type	figArea0_fig5_type	Set/Get	8: Rectangle, 16: Ellipse, 64: Circumference, 512: Polygon
:	:	:	:	:
91,601	figure6 Type	figArea0_fig6_type	Set/Get	8: Rectangle, 16: Ellipse, 64: Circumference, 512: Polygon
:	:	:	:	:
91,701	figure7 Type	figArea0_fig7_type	Set/Get	8: Rectangle, 16: Ellipse, 64: Circumference, 512: Polygon
:	:	:	:	:
91,760	figure7 Polygon Point10 Position Y	figArea0_fig7_poly- gon_y9	Set/Get	-99,999 to 99,999

- *1. Reference coordinate when "Unit." is selected in the method area of the Ref. setting tab can be acquired.
- *2. Reference coordinate when "Typical value" is selected in the method area of the Ref. setting tab can be configured or acquired.

2-9 Ec Corner

This processing item is not available in the FHV series.

This processing item measures a corner position (corner) of a work.

The intersection of two lines generated from the edge information of two sides of a square work is measured.

A desired corner can be measured by setting the length, direction, edge intensity and other conditions.

Used in the Following Case

When you want to align the work position based on the feature of its corner:

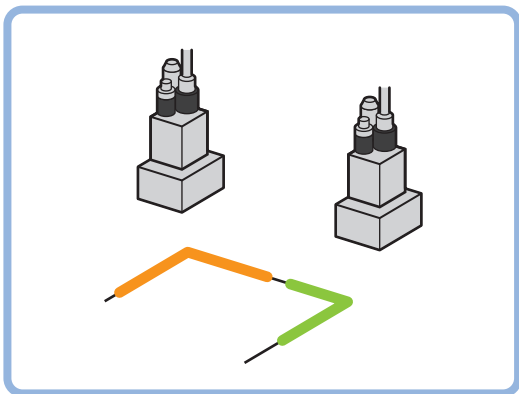

Precautions for Correct Use

Processing is different for color images and monochrome images. When the camera type used in the previous setup was changed to color or monochrome type, perform the settings again.

2-9-1 Settings Flow (Ec Corner)

To set Ec Corner, follow the steps below.

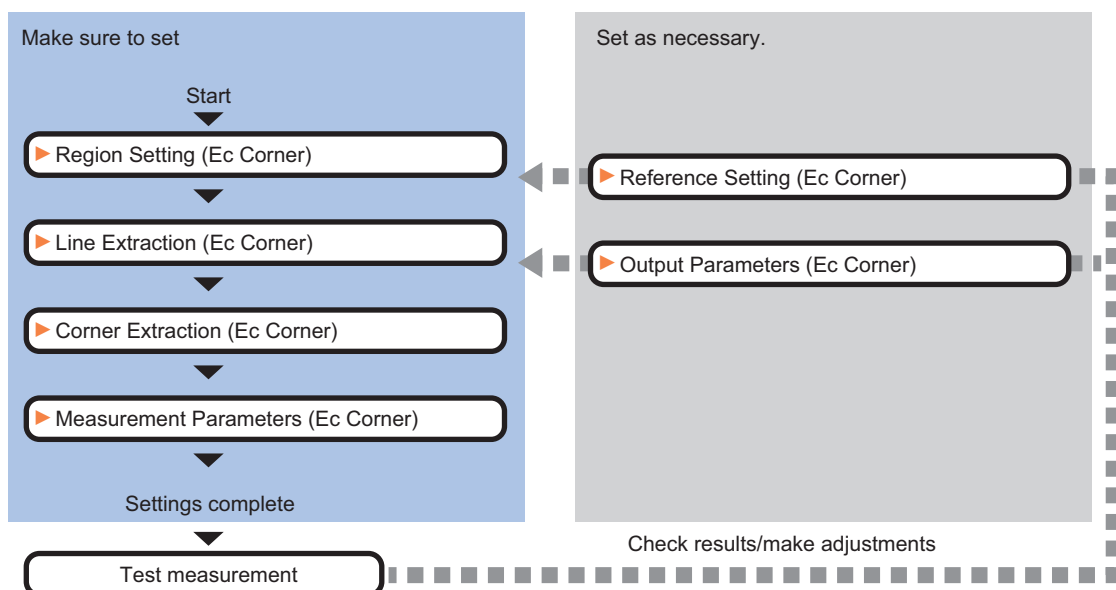

List of Ec Corner Items

Item	Description
Region setting	Sets the measurement area. It is possible to target the entire screen, but restricting the range can shorten the processing time. <i>2-9-2 Region Setting (Ec Corner) on page 2-139</i>
Ref. setting	This item can be changed as necessary. Specify the reference position within the camera's field of view. <i>2-9-3 Reference Setting (Ec Corner) on page 2-140</i>
Line extraction	This item sets the conditions for extracting a line. <i>2-9-4 Line Extraction (Ec Corner) on page 2-141</i>
Corner extraction	This item sets the conditions for extracting a corner. <i>2-9-5 Corner Extraction (Ec Corner) on page 2-143</i>
Measurement parameter	Set the sort conditions/judgment conditions of corners. Data of the specified number is output as measurement data. <i>2-9-6 Measurement Parameters (Ec Corner) on page 2-145</i>
Output parameter	This item can be changed as necessary. Normally, the factory default value will be used. Use the output parameter to specify how to handle the coordinates. <i>2-9-7 Output Parameters (Ec Corner) on page 2-146</i>

2-9-2 Region Setting (Ec Corner)

This item is used to set up the measurement area.

Use the rectangle to set up the measurement region for *Ec Corner*.

- 1** In the Item tab area, click **Region setting**.
- 2** Use the drawing tools to set the measurement region.
- 3** Click **OK** in the *Figure setting* area.
 - **OK**: Changes the settings and returns to the previous menu.
 - **Cancel**: Changes are discarded. Returns to the previous menu.
 - **Apply**: Updates the settings without leaving edit window.
- 4** Click **Edge extraction** then confirm the edge extraction image.
If the profile of the measurement object is interrupted or has too many edges, adjust the edge level.

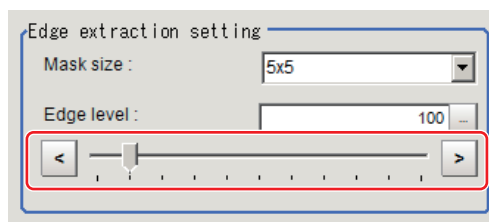

Setting item	Setting value [Factory default]	Description
Mask size	<ul style="list-style-type: none"> • 3x3 • [5x5] • 7x7 • 9x9 	Select the range of pixels which are used to extract the edge. With a larger <i>mask size</i> , search is less affected by variation in pixels.
Edge level	0 to 1,000 [100]	Change this when the edge is hard to see due to low contrast against the background or when unnecessary background noise must be removed. The smaller the value, the easier it is to find edges. The larger the value, the less noise will affect finding edges.

2-9-3 Reference Setting (Ec Corner)

When the model is set, this position is automatically set at the same time as the reference position. This item can be set to change the reference position to any desired position. This is handy for measuring the position deviation from a certain position.

A reference position can be set either directly or by referencing a unit.

Specifying directly

Click a position on the image you want to use as a reference position, or input coordinate data for that point.

- 1** In the Item tab area, click **Ref. setting**.
In the *Display* area, the current reference position will be displayed as the crosshair cursor.



- 2** In the *Method* area, select *Numerical*.

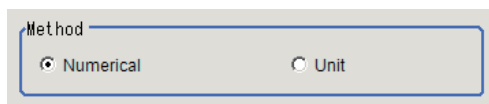

- 3** Click the position to be set as the reference.



Additional Information

Displaying the image enlarged makes this clicking easier.
For details, refer to *Appendixes Basic Knowledge about Operations Using the Zoom Function in the Vision System FH/FHV Series User's Manual* (Cat. No. Z365).

- 4** Make fine adjustments using numeric value inputs or the arrow buttons as required.

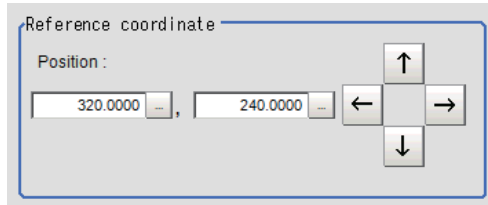

- 5 To remeasure on the displayed image and set the reference, click the **Measure ref.** button.
- 6 To use data before position compensation for the reference setting coordinates, place a check at *Use point coordinate before scroll*.

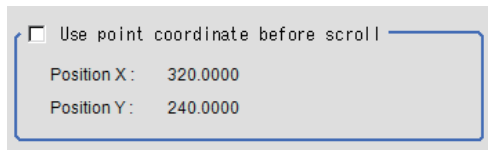

Referencing a Unit

Set a reference by referencing a detection point unit with registered X coordinate, Y coordinate and angle data.

- 1 In the Item tab area, click **Ref. setting**.
In the *Display* area, the current reference position will be displayed as the crosshair cursor.
- 2 In the *Method* area, select *Unit*.

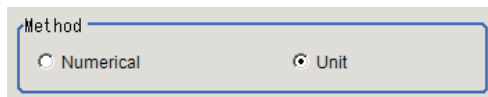

- 3 In the *Unit* area, select a detection point unit in the scene.

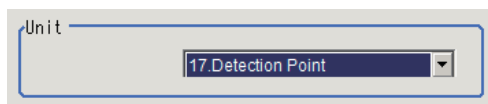

Performing the next measurement will display the reference.

2-9-4 Line Extraction (Ec Corner)

This item sets the conditions for extracting a line.

- 1 In the Item tab area, click **Line extraction**.
- 2 In the *Line extraction cond.* area, set the conditions for extracting a line.

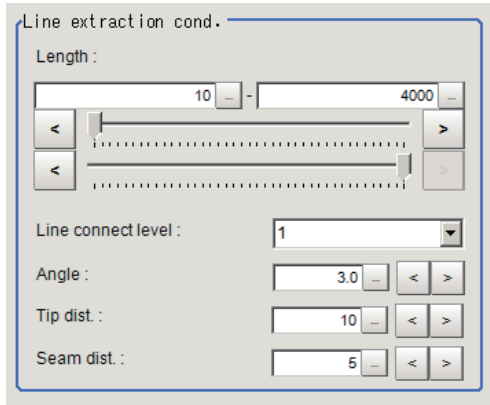

Setting item	Setting value [Factory default]	Description
Length	5 to 4,000 [10] to [4,000]	Set the length of edges to be extracted.
Line connect level	<ul style="list-style-type: none"> • [1] • 2 • 3 • 4 • 5 • Custom 	Select the degree to which fragmented lines detected by edge extraction are connected. The higher the level, the more likely the lines are connected.
Angle	0.0 to 30.0 [3.0]	Set the angle range to be used when two lines are connected. Increasing this value allows two lines of different inclinations to be connected.
Tip dist.	0 to 1,000 [10]	Set the vertex distance to be used when two lines are connected. Increasing this value allows distant lines to be connected.
Seam dist.	0 to 1,000 [5]	Set the distance condition to be used when two lines are connected, where an extension of one line comes closest to the vertex of the other line. Increasing this value allows lines offset vertically to the lines to be connected.

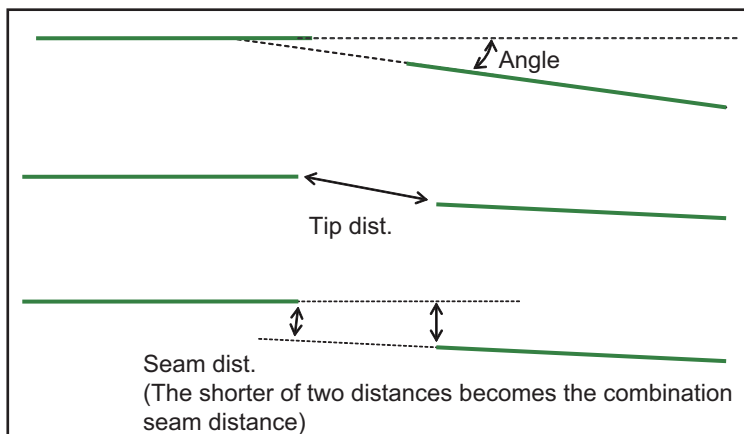

2-9-5 Corner Extraction (Ec Corner)

This item sets the conditions for extracting a corner.

- 1 In the Item tab area, click **Corner extraction**.
- 2 In the *Line 0 cond.* area, set the conditions for line 0.

Line 0 cond.

Length : -

Angle : ± < >

Overrun : -

Setting item	Setting value [Factory default]	Description
Length	5 to 4,000 [10] to [4,000]	Set the length for extracting line 0.
Angle	0 to 359 [0]	Set the angle for extracting line 0.
Overrun	-1,000 to 1,000 [-10] to [10]	Set the length range to be used when specifying whether the tips of two lines that constitute a corner have penetrated through the corner or are not reaching the corner (unit: pix). If the tips have penetrated through the corner, the overrun length becomes a positive value; whereas, if the tips are not reaching the corner, the overrun length becomes a negative value.



Overrun length
(positive
value)



Overrun length
(negative
value)

- 3 In the *Line 1 cond.* area, set the conditions for line 1.

Line 1 cond.

Length : -

Angle : ± < >

Overrun : -

Setting item	Setting value [Factory default]	Description
Length	5 to 4,000 [10] to [4,000]	Set the length for extracting line 1.
Angle	0 to 359 [0]	Set the angle for extracting line 1.

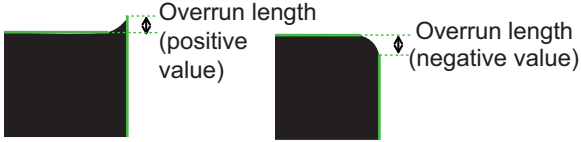
Setting item	Setting value [Factory default]	Description
Overrun	-1,000 to 1,000 [-10] to [10]	Set the length range to be used when specifying whether the tips of two lines that constitute a corner have penetrated through the corner or are not reaching the corner (unit: pix). If the tips have penetrated through the corner, the overrun length becomes a positive value; whereas, if the tips are not reaching the corner, the overrun length becomes a negative value. 

4 In the *Corner extraction cond.* area, set the conditions for corners.

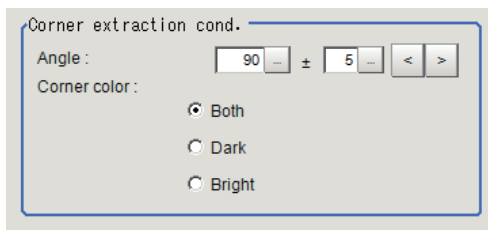

Setting item	Setting value [Factory default]	Description
Angle	10 to 350 [90]	Set the angle range for a corner.
±	0 to 180 [5]	Set the margin of angle error.
Corner color	<ul style="list-style-type: none"> • [Both] • Dark • Bright 	Select the light/dark relationship of the corner and background.

5 If necessary, click **Advanced setting** and set the intersection fusion condition.

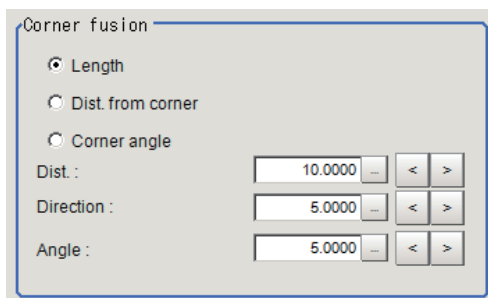

Setting item	Setting value [Factory default]	Description
Corner fusion	<ul style="list-style-type: none"> • [Length] • Dist. from corner • Corner angle 	<p>If all detected corners include two corners that each meet all of the three conditional relationships of <i>Fusion distance</i>, <i>Fusion line angle range</i> and <i>Fusion corner angle range</i>, fuse the corners into one according to the priorities specified below.</p> <ul style="list-style-type: none"> • Length: Keep the corner with the longer total length of the two lines constituting the corner. • Dist. from corner: Keep the corner with the smaller total overrun of the two lines. • Corner angle: Keep the corner whose angle formed by the two lines is closer to the <i>Angle range</i> set as a corner condition.
Dist.	0 to 1,000.0000 [10.0000]	Set the linear distance between the corners.
Direction	0 to 20.0000 [5.0000]	Set the difference between the angles formed by the two sets of lines constituting the corners.
Angle	0 to 20.0000 [5.0000]	Set the angle difference between the corners.

2-9-6 Measurement Parameters (Ec Corner)

Set the sort conditions and judgment conditions of corners.
Data of the specified number is output as measurement data.

- 1 In the Item tab area, click **Measurement**.
- 2 In the *Sort cond.* area, set the sorting conditions.

Sort cond.

Order : Corner X

Ascendin Descendi

Corner No. : 0

Setting item	Setting value [Factory default]	Description
Order	<ul style="list-style-type: none"> • [Corner X] • Corner Y • Length 	Select the sorting method for the measurement results.
	<ul style="list-style-type: none"> • [Ascending] • Descending 	
Corner No.	0 to 99 [0]	Set the corner number for the data to be output.

- 3 When the setting has been changed, click **Measure** in the *Detail* area to verify whether measurements can be made correctly.

Test measuring of this item.

Measure

4 Set up the judgment condition.

Setting item	Setting value	Description
Corner X	-99,999.9999 to 99,999.9999	Set the range of X coordinates of corner that is judged to be OK.
Corner Y	-99,999.9999 to 99,999.9999	Set the range of Y coordinates of corner that is judged to be OK.
Angle	0.0000 to 360.0000	Specify the formed angles that are judged to be OK.
Count	1 to 100	Specify the number of detections of corner that is judged to be OK.

2-9-7 Output Parameters (Ec Corner)

Specify how to treat the coordinates to be output to the external device as measurement results. This item can be changed if necessary. Normally, the factory default value will be used.



Precautions for Correct Use

After setting up the measurement parameters, changing the output parameters will cause measurement results to vary accordingly. If the output parameters have been changed, re-specify the measurement, too.

- 1 Click **Output parameter** in the Item tab area.
- 2 Specify each of the following items.

Setting item	Setting value [Factory default]	Description
Output coordinates	<ul style="list-style-type: none"> • [After scroll] • Before scroll 	As measurement results, select whether to output coordinate values to external devices before or after the position deflection correction is applied.
Calibration	<ul style="list-style-type: none"> • ON • [OFF] 	Select whether to reflect the calibration in the values output to the external device as measurement results. <ul style="list-style-type: none"> • ON: Output the coordinates converted into actual dimensions. • OFF: Output the camera coordinate values.
Reflect to overall judgment	<ul style="list-style-type: none"> • [ON] • OFF 	Enables choosing whether or not the judgement results of this processing unit is reflected in the scene overall judgment.



Additional Information

For output coordinates and calibration, refer to *Appendixes Measurement Mechanism Handling Coordinates* in the *Vision System FH/FHV Series User's Manual (Cat. No. Z365)*.

2-9-8 Key Points for Test Measurement and Adjustment (Ec Corner)

The following content is displayed in the *Detail result* area as text.

Displayed item	Description
Judge	Judgment results 0: No judgment (unmeasured) 1: Judgment result OK -1: Judgment result NG -10: Error (image format mismatch) -11: Error (unregistered model) -12: Error (insufficient memory) -20: Error (other errors)
Corner X	X Coordinate of measured corner
Corner Y	Y coordinate of measured corner
Angle	Formed angle of measured corner
Count	No. of detections of corner

The image specified in the Sub-image number in the image display setting is displayed in the *Image Display* area.

Sub-image number	Description of image to be displayed
0	Measurement image

Key Points for Adjustment (Ec Corner)

Adjust the setting parameters referring to the following points.

● When the measurement results are unstable

Parameter to be adjusted	Remedy
Measurement parameter	Reduce the range between the upper and lower limits of a line length range for extracting lines, to reduce false detections.
	Raise the <i>Line connection level</i> to prevent the lines constituting the corners to be detected from being interrupted.
	Set the conditions for <i>Extracting corners</i> as narrow as possible to reduce false detections.

● When the processing speed is slow

Parameter to be adjusted	Remedy
Region setting	Specify a value as small as possible for FigureInfo = Region.
Measurement parameter	Minimize the range between the upper and lower limits of a line length range for extracting lines as narrow as possible.
	Minimize the range between the upper and lower limits of the <i>Overrun range</i> for the <i>Extracting corners</i> .
	Minimize the range between the upper and lower limits of the <i>Length range</i> for the <i>Extracting corners</i> .
	Minimize the range between the upper and lower limits of the <i>Angle range</i> for the <i>Extracting corners</i> .

● When judgement is NG

Parameter to be adjusted	Remedy
Corner extraction	Expand and extend the <i>Override range</i> in both the positive and negative directions so that corners are formed.

2-9-9 Measurement Results for Which Output Is Possible (Ec Corner)

The following values can be output using processing items related to result output. It is also possible to reference measurement values from calculation expressions and other processing units.

Measurement items	Character string	Description
Judge	JG	Judgment results 0: No judgment (unmeasured) 1: Judgment result OK -1: Judgment result NG -10: Error (image format mismatch) -11: Error (unregistered model) -12: Error (insufficient memory) -20: Error (other errors)
Corner X	X	X Coordinate of measured corner
Corner Y	Y	Y coordinate of measured corner
Angle	TH	Formed angle of measured corner
Count	CT	Count
Ref. position X	SX	Ref. position X
Ref. position Y	SY	Ref. position Y
Corner XN (N = 0 to 99)	XN	Corner coordinate XN
Corner YN (N = 0 to 99)	YN	Corner coordinate YN
Angle N (N = 0 to 99)	THN	Formed angle N of measured corner
Angle N of line 0 (N = 0 to 99)	DIRLN	Inclination N of line 0
Angle N of line 1 (N = 0 to 99)	DIRRN	Inclination N of line 1

2-9-10 External Reference Tables (Ec Corner)

No.	Data name	Data ident	Set/Get	Data range
0	Judge	judge	Get only	0: No judgment (unmeasured), 1: Judgment result OK, -1: Judgment result NG, -10: Error (image format mismatch), -11: Error (unregistered model), -12: Error (insufficient memory), -20: Error (other errors)
5	Count	cornerCount	Get only	0 to 100
6	Corner coordinate X	cornerX	Get only	-99,999.9999 to 99,999.9999

No.	Data name	Data ident	Set/Get	Data range
7	Corner coordinate Y	cornerY	Get only	-99,999.9999 to 99,999.9999
8	Angle	angle	Get only	0 to 360
9	Reference position X coordinate	referenceX	Get only	-99,999.9999 to 99,999.9999
10	Reference position Y coordinate	referenceY	Get only	-99,999.9999 to 99,999.9999
11	Reference angle	referenceAngle	Get only	-180 to 180
101	Output coordinate	outputCoordinate	Set/Get	0: After scroll, 1: Before scroll
102	Calibration	calibration	Set/Get	0: OFF, 1: ON
103	Reflect to overall judgement	overallJudge	Set/Get	0: ON, 1: OFF
120	Edge extraction level	edgeThresh	Set/Get	0 to 1,000
121	Filter size	maskSize	Set/Get	0: 3x3, 1: 5x5, 2: 7x7, 3: 9x9
122	Lower limit of line length	minExtLength	Set/Get	5 to 4,000
123	Upper limit of line length	maxExtLength	Set/Get	5 to 4,000
124	Combination angle	connectDir	Set/Get	0.0 to 30.0
125	Combination tip distance	connectTipDist	Set/Get	0 to 1,000
126	Combination seam distance	connectSeamDist	Set/Get	0 to 1,000
127	Lower limit of line 0 length range	minLineLength0	Set/Get	5 to 4,000
128	Upper limit of line 0 length range	maxLineLength0	Set/Get	5 to 4,000
129	Lower limit of line 1 length range	minLineLength1	Set/Get	5 to 4,000
130	Upper limit of line 1 length range	maxLineLength1	Set/Get	5 to 4,000
131	Line 0 line angle	lineAngle0	Set/Get	0 to 359
132	Line 0 line angle range	lineAngleRange0	Set/Get	0 to 180
133	Line 1 line angle	lineAngle1	Set/Get	0 to 359
134	Line 1 line angle range	lineAngleRange1	Set/Get	0 to 180
135	Formed angle	cornerAngle	Set/Get	10 to 350
136	Formed angle range	cornerAngleRange	Set/Get	0 to 180
137	Lower limit of line 0 overrun range	minOverRun0	Set/Get	-1,000 to 1,000
138	Upper limit of line 0 overrun range	maxOverRun0	Set/Get	-1,000 to 1,000
139	Lower limit of line 1 overrun range	minOverRun1	Set/Get	-1,000 to 1,000
140	Upper limit of line 1 overrun range	maxOverRun1	Set/Get	-1,000 to 1,000
141	Detection object color	colorObjectBright	Set/Get	0: Both, 1: Dark, 2: Bright

No.	Data name	Data ident	Set/Get	Data range
149	Sort condition	sortMode	Set/Get	0: Cross point X, 1: Cross point Y, 2: Length
150	Sort order	sortOperant	Set/Get	0: Ascending, 1: Descending
151	Cross No.	outputNo	Set/Get	0 to 99
155	Corner fusion ON/OFF	cornerMargeFlag	Set/Get	0: OFF, 1: ON
156	Fusion distance	margeLength	Set/Get	0 to 1,000
157	Fusion line angle range	margeDirection	Set/Get	0 to 20
158	Fusion corner angle range	margeAngle	Set/Get	0 to 20
159	Corner fusion condition	margeRemainState	Set/Get	0: Length, 1: Distance from corner, 2: Corner angle
160	Lower limit of corner X	lowerJudgeX	Set/Get	-99,999.9999 to 99,999.9999
161	Upper limit of corner X	upperJudgeX	Set/Get	-99,999.9999 to 99,999.9999
162	Lower limit of corner Y	lowerJudgeY	Set/Get	-99,999.9999 to 99,999.9999
163	Upper limit of corner Y	upperJudgeY	Set/Get	-99,999.9999 to 99,999.9999
164	Lower limit of angle	lowerJudgeAngle	Set/Get	0 to 360
165	Upper limit of angle	upperJudgeAngle	Set/Get	0 to 360
166	Lower limit of count	lowerJudgeCorner-Count	Set/Get	0 to 100
167	Upper limit of count	upperJudgeCorner-Count	Set/Get	0 to 100
168	Reference position X	referencePosX	Set/Get	0 to 99,999.9999
169	Reference position Y	referencePosY	Set/Get	0 to 99,999.9999
171	Line connection level	lineConnerctLevel	Set/Get	0: 1, 1: 2, 2: 3, 3: 4, 4: 5, 5: Custom
173	Setting unit of reference coordinate	refUnitNo	Set/Get	-1 to 9,999
174	Setting type of reference coordinate	refSettingType	Set/Get	0: Numerical, 1: Unit
176	Use point coordinate before scroll	beforeScrollRefMode	Set/Get	0: Not use, 1: Use
177	Reference X before scroll	beforeScrollRefPosX	Set/Get	-99,999.9999 to 99,999.9999
178	Reference Y before scroll	beforeScrollRefPosY	Set/Get	-99,999.9999 to 99,999.9999
6,002	Format	cameraColor	Set/Get	1: Monochrome camera 2: Color camera
10,000+N (N=0 to 99)	Corner coordinate X	cornerX00 to cornerX99	Get only	-99,999.9999 to 99,999.9999
10,100+N (N=0 to 99)	Corner coordinate Y	cornerY00 to cornerY99	Get only	-99,999.9999 to 99,999.9999
10,200+N (N=0 to 99)	Formed angle	cornerAngle00 to cornerAngle99	Get only	10 to 350
90,000	figure0 Count	figArea0_count	Set/Get	0 to 1

No.	Data name	Data ident	Set/Get	Data range
90,001	figure0 Type	figArea0_fig0_type	Set/Get	8: Rectangle
90,002	figure0 mode	figArea0_fig0_mode	Set/Get	0: OR
90,014	figure0 Rectangle Upper left position X	figAr- ea0_fig0_box_X0	Set/Get	-99,999 to 99,999
90,015	figure0 Rectangle Upper left position Y	figAr- ea0_fig0_box_Y0	Set/Get	-99,999 to 99,999
90,016	figure0 Rectangle Lower right position X	figAr- ea0_fig0_box_X1	Set/Get	-99,999 to 99,999
90,017	figure0 Rectangle Lower right position Y	figAr- ea0_fig0_box_Y1	Set/Get	-99,999 to 99,999
90,099	figure0 Update	figArea0_update	Set only	1: Update

2-10 Ec Cross

This processing item is not available in the FHV series.

Detect crosshair shapes created by crosshair marks and other edges.

The center position of a crosshair shape is measured using the lines created by the edge information on each side of the crosshair.

A desired crosshair shape can be measured by specifying the length, direction, edge intensity and other conditions.

Used in the Following Case

When you want to align the work position based on a crosshair-shaped mark:

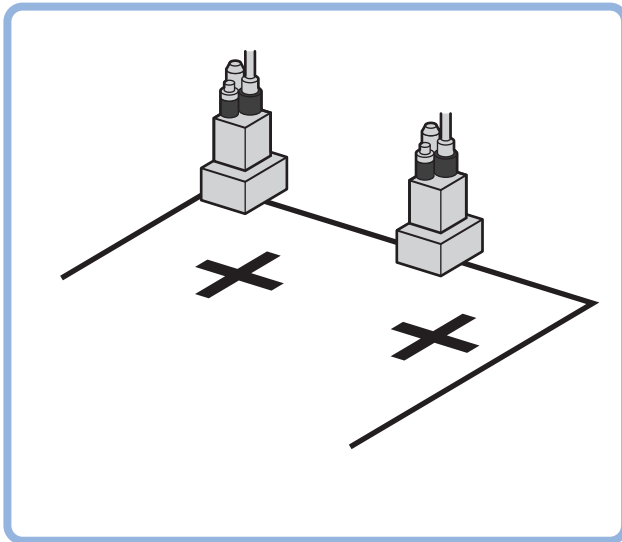

Precautions for Correct Use

Processing is different for color images and monochrome images. When the camera type used in the previous setup was changed to color or monochrome type, perform the settings again.

2-10-1 Settings Flow (Ec Cross)

To set Ec Cross, follow the steps below.

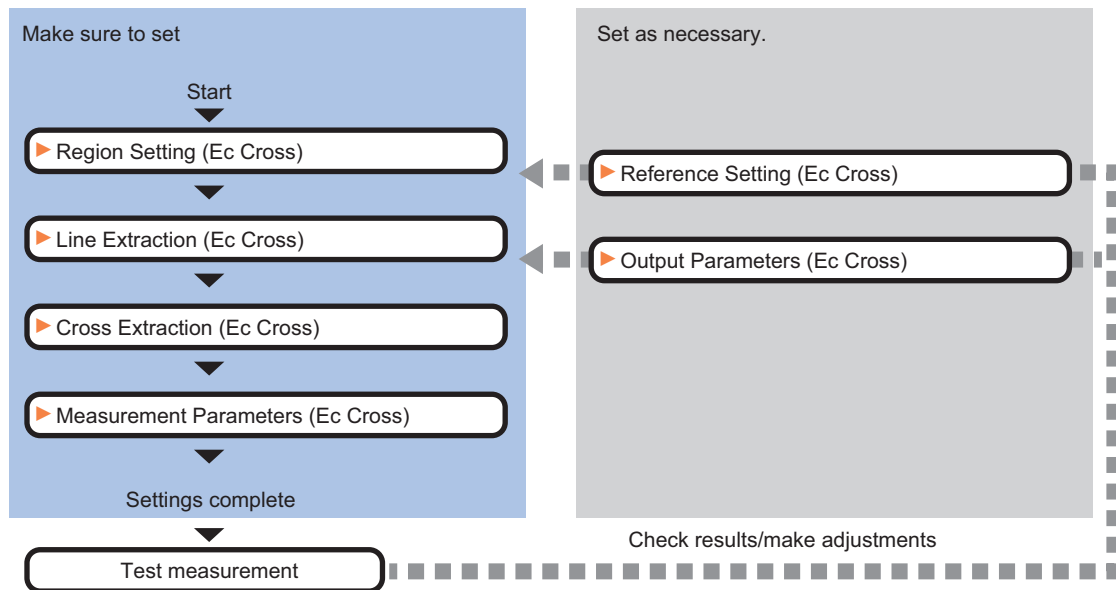

List of Ec Cross Items

Item	Description
Region setting	Sets the measurement area. It is possible to target the entire screen, but restricting the range can shorten the processing time. <i>2-10-2 Region Setting (Ec Cross) on page 2-154</i>
Ref. setting	This item can be changed as necessary. Specify the reference position within the camera's field of view. <i>2-10-3 Reference Setting (Ec Cross) on page 2-155</i>
Line extraction	This item sets the conditions for extracting a line. <i>2-10-4 Line Extraction (Ec Cross) on page 2-156</i>
Cross extraction	Set the conditions for extraction a crosshair shape. <i>2-10-5 Cross Extraction (Ec Cross) on page 2-158</i>
Measurement parameter	Set the sort conditions/judgment conditions of crosshair shapes. Data of the specified number is output as measurement data. <i>2-10-6 Measurement Parameters (Ec Cross) on page 2-159</i>
Output parameter	This item can be changed as necessary. Normally, the factory default value will be used. Use the output parameter to specify how to handle the coordinates. <i>2-10-7 Output Parameters (Ec Cross) on page 2-160</i>

2-10-2 Region Setting (Ec Cross)

This item is used to set up the measurement area.

Use the rectangle to set up the measurement region for **Ec Cross**.

- 1** In the Item tab area, click **Region setting**.
- 2** Use the drawing tools to set the measurement region.
- 3** Click **OK** in the *Figure setting* area.
 - **OK**: Changes the settings and returns to the previous menu.
 - **Cancel**: Changes are discarded. Returns to the previous menu.
 - **Apply**: Updates the settings without leaving edit window.
- 4** Click **Edge extraction**, and then confirm the edge extraction image.
If the profile of the measurement object is interrupted or has too many edges, adjust the edge level.

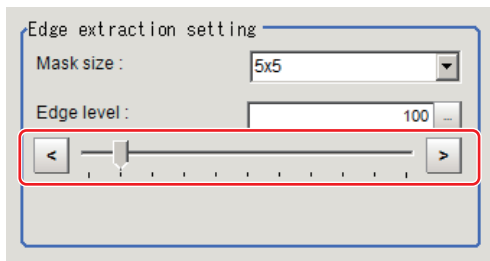

Setting item	Setting value [Factory default]	Description
Mask size	<ul style="list-style-type: none"> • 3x3 • [5x5] • 7x7 • 9x9 	Select the range of pixels which are used to extract the edge. With a larger <i>mask size</i> , search is less affected by variation in pixels.
Edge level	0 to 1,000 [100]	Change this when the edge is hard to see due to low contrast against the background or when unnecessary background noise must be removed. The smaller the value, the easier it is to find edges. The larger the value, the less noise will affect finding edges.

2-10-3 Reference Setting (Ec Cross)

When the model is set, this position is automatically set at the same time as the reference position. This item can be set to change the reference position to any desired position. This is handy for measuring the position deviation from a certain position.

A reference position can be set either directly or by referencing a unit.

Specifying Directly

Click a position on the image you want to use as a reference position, or input coordinate data for that point.

- 1 In the Item tab area, click **Ref. setting**.
In the *Display* area, the current reference position will be displayed as the crosshair cursor.



- 2 In the *Method* area, select *Numerical*.

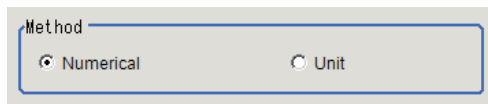

- 3 Click the position to be set as the reference.



Additional Information

Displaying the image enlarged makes this clicking easier.

For details, refer to *Appendixes Basic Knowledge about Operations Using the Zoom Function in the Vision System FH/FHV Series User's Manual (Cat. No. Z365)*.

- 4 Make fine adjustments using numeric value inputs or the arrow buttons as required.

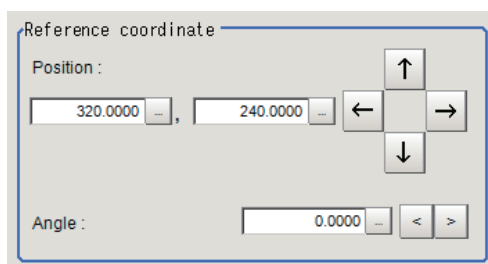

- 5 Set the reference angle with a numeric value.
- 6 To remeasure on the displayed image and set the reference, click **Measure ref..**

To update the reference angle at the time of reference measurement, place a check at *Update the angle when measure ref.* .

Update the angle when measure ref. Measure ref.

- 7** To use data before position compensation for the reference setting coordinates, place a check at *Use point coordinate before scroll.*

Use point coordinate before scroll

Position X : 320.0000
Position Y : 240.0000
Angle : 0.0000



Precautions for Correct Use

If you check *Use point coordinate before scroll*, do not use the following processing items. Otherwise, correct search results cannot be obtained.

- Precise Calibration
- Calibration Data Reference

Referencing a Unit

Set a reference by referencing a detection point unit with registered X coordinate, Y coordinate and angle data.

- 1** In the Item tab area, click **Ref. setting**.
In the *Display* area, the current reference position will be displayed as the crosshair cursor.
- 2** In the *Method* area, select *Unit*.

Method

Numerical Unit

- 3** In the *Unit* area, select a detection point unit in the scene.

Unit

17.Detection Point

Performing the next measurement will display the reference.

2-10-4 Line Extraction (Ec Cross)

This item sets the conditions for extracting a line.

- 1 In the Item tab area, click **Line extraction**.
- 2 In the *Line extraction cond.* area, set the conditions for extracting a line.

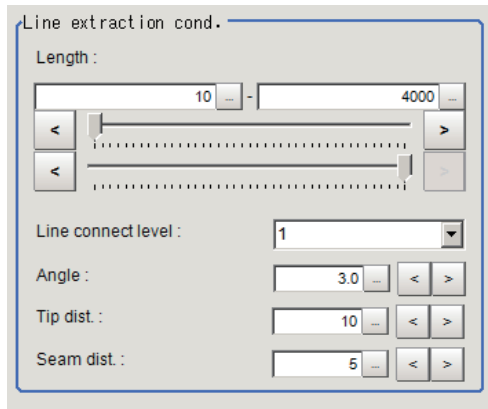

Setting item	Setting value [Factory default]	Description
Length	5 to 4,000 [10] to [4,000]	Set the length of edges to be extracted.
Line connect level	<ul style="list-style-type: none"> • [1] • 2 • 3 • 4 • 5 • Custom 	Select the degree to which fragmented lines detected by edge extraction are connected. The higher the level, the more likely the lines are connected.
Angle	0.0 to 30.0 [3.0]	Set the angle range to be used when two lines are connected. Increasing this value allows two lines of different inclinations to be connected.
Tip dist.	0 to 1,000 [10]	Set the vertex distance to be used when two lines are connected. Increasing this value allows distant lines to be connected.
Seam dist.	0 to 1,000 [5]	Set the distance condition to be used when two lines are connected, where an extension of one line comes closest to the vertex of the other line. Increasing this value allows lines offset vertically to the lines to be connected.

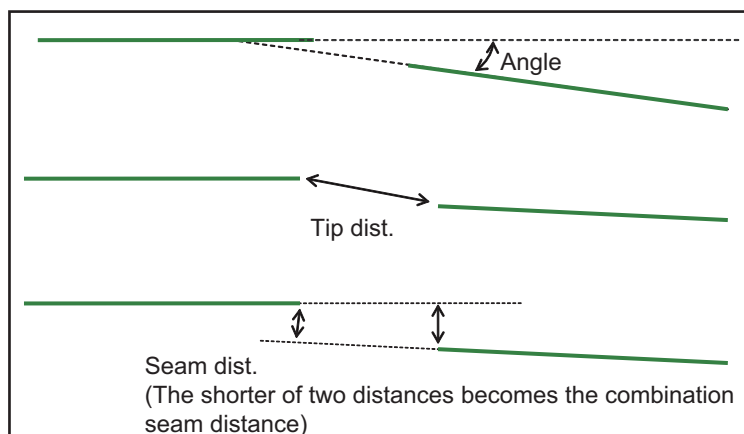

2-10-5 Cross Extraction (Ec Cross)

Set the conditions for intersecting lines.

- 1 In the Item tab area, click **Cross extraction**.
- 2 In the *Line 0 cond.* area, set the conditions for parallel line 0.

Line 0 cond.

Length : -

Width : -

Setting item	Setting value [Factory default]	Description
Length	5 to 4,000 [10] to [4000]	Set the length of parallel line 0.
Width	1 to 1,000 [10] to [100]	Set the width of parallel line 0.

- 3 In the *Line 1 cond.* area, set the conditions for parallel line 1.

Line 1 cond.

Length : -

Width : -

Setting item	Setting value [Factory default]	Description
Length	5 to 4,000 [10] to [4000]	Set the length of parallel line 1.
Width	1 to 1,000 [10] to [100]	Set the width of parallel line 1.

- 4 In the *Advanced cond.* area, set the detection conditions.

Advanced cond.

Underrun0 : -

Underrun1 : -

Detection line count :

Setting item	Setting value [Factory default]	Description
Underrun 0	0 to 1,000 [0] to [1,000]	Set the level to which a cross with a rounded or pointed intersection or intersection concealed due to external disturbance is allowed. Set the range of crosses not reaching the intersection that are still recognized as crosses.
Underrun 1	0 to 1,000 [0] to [1,000]	
Detection line count	<ul style="list-style-type: none"> • 2 • 3 • [4] 	Set a number of parallel line sets that are judged forming a cross. If the image does not have external disturbances, a total of four sets of parallel lines, which configure the cross, are detected, and those parallel lines are at the top, bottom, left, and right sides when looked from the center of the cross. When a straight line is not detected by being hidden or broken by an external disturbance, detection of a cross becomes possible by changing a number of detection lines. At least 2 sets must be set. (In case of 2 sets, each set of parallel lines has to be straight.)

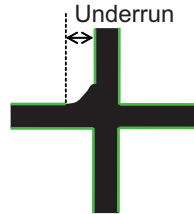

- 5** In the *Cross brightness* area, set the brightness relationship of the crosshair and background.

Cross brightness

Both
 Dark
 Bright

Setting item	Setting value [Factory default]	Description
Cross brightness	<ul style="list-style-type: none"> • [Both] • Dark • Bright 	Select the light/dark relationship of the crosshair and background.

2-10-6 Measurement Parameters (Ec Cross)

Set the sort conditions/judgement conditions of crosshairs.

- 1** In the Item tab area, click **Measurement**.
- 2** In the *Sort cond.* area, set the sorting conditions.

Sort cond.

Order:

Ascending Descendin

Cross No.:

Setting item	Setting value [Factory default]	Description
Order	<ul style="list-style-type: none"> • [Cross X] • Cross Y • Length 	Select the sorting method to be applied to those measurement results where there are multiple intersections.
	<ul style="list-style-type: none"> • [Ascending] • Descending 	
Cross No.	0 to 9 [0]	Set the cross number for the data to be output.

- 3** When the setting has been changed, click **Measure** in the *Detail* area to verify whether measurements can be made correctly.

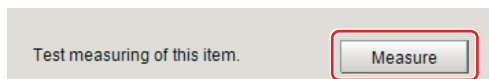

- 4** Set up the judgment condition.

Setting item	Setting value	Description
Cross X	-99,999.9999 to 99,999.9999	Set the range of X coordinates of crosshair that is judged to be OK.
Cross Y	-99,999.9999 to 99,999.9999	Set the range of Y coordinates of crosshair that is judged to be OK.
Angle	-45 to 45	Set the crosshair angles that are judged to be OK.
Count	1 to 10	Set the number of detections of crosshair that is judged to be OK.

2-10-7 Output Parameters (Ec Cross)

Specify how to treat the coordinates to be output to the external device as measurement results. This item can be changed if necessary. Normally, the factory default value will be used.



Precautions for Correct Use

After setting up the measurement parameters, changing the output parameters will cause measurement results to vary accordingly. If the output parameters have been changed, re-specify the measurement, too.

- 1** Click **Output parameter** in the Item tab area.
- 2** Specify each of the following items.

Setting item	Setting value [Factory default]	Description
Output coordinates	<ul style="list-style-type: none"> • [After scroll] • Before scroll 	As measurement results, select whether to output coordinate values to external devices before or after the position deflection correction is applied.
Calibration	<ul style="list-style-type: none"> • ON • [OFF] 	Select whether to reflect the calibration in the values output to the external device as measurement results. <ul style="list-style-type: none"> • ON: Output the coordinates converted into actual dimensions. • OFF: Output the camera coordinate values.

Setting item	Setting value [Factory default]	Description
Reflect to overall judgment	<ul style="list-style-type: none"> • [ON] • OFF 	Enables choosing whether or not the judgement results of this processing unit is reflected in the scene overall judgment.



Additional Information

For output coordinates and calibration, refer to *Appendixes Measurement Mechanism Handling Coordinates* in the *Vision System FH/FHV Series User's Manual (Cat. No. Z365)*.

2-10-8 Key Points for Test Measurement and Adjustment (Ec Cross)

The following content is displayed in the *Detail result* area as text.

Displayed item	Description
Judge	Judgment results 0: No judgment (unmeasured) 1: Judgment result OK -1: Judgment result NG -10: Error (image format mismatch) -11: Error (unregistered model) -12: Error (insufficient memory) -20: Error (other errors)
Cross X	X coordinate of measured crosshair
Cross Y	Y coordinate of measured crosshair
Angle	Angle of measured crosshair
Count	No. of detections of crosshair

The image specified in the Sub-image number in the image display setting is displayed in the *Image Display* area.

Sub-image number	Description of image to be displayed
0	Measurement image

Key Points for Adjustment (Ec Cross)

Adjust the setting parameters referring to the following points.

● When the measurement results are unstable

Parameter to be adjusted	Remedy
Measurement parameter	Reduce the range between the upper and lower limits of a line length range for extracting lines, to reduce false detections.
	Raise the <i>Line connection level</i> to prevent the lines constituting the corners to be detected from being interrupted.
	Set conditions for <i>Extracting crosses</i> as narrow as possible to reduce false detections.

● When the processing speed is slow

Parameter to be adjusted	Remedy
Region setting	Make the search region as small as possible.
Measurement parameter	Minimize the range between the upper and lower limits of a line length range for extracting lines as narrow as possible.
	Minimize the range between the upper and lower of the <i>Underrun distance</i> as narrow as possible set as a part of <i>Cross extracting</i> conditions.
	Minimize the range between the upper and lower of the <i>Cross extracting width</i> as narrow as possible.
	Minimize the range between the upper and lower limits of the <i>Cross extracting length</i> as narrow as possible.
	Raise a value for the <i>No. of detection lines</i> for the <i>Extracting crosses</i> .

● When judgement is NG

Parameter to be adjusted	Remedy
Cross extraction	Expand and extend the <i>Overrun range</i> in both the positive and negative directions so that corners are formed.

2-10-9 Measurement Results for Which Output Is Possible (Ec Cross)

The following values can be output using processing items related to result output. It is also possible to reference measurement values from calculation expressions and other processing units.

Measurement items	Character string	Description
Judge	JG	Judgment results 0: No judgment (unmeasured) 1: Judgment result OK -1: Judgment result NG -10: Error (image format mismatch) -11: Error (unregistered model) -12: Error (insufficient memory) -20: Error (other errors)

Measurement items	Character string	Description
Cross coordinate X	X	X coordinate of measured crosshair
Cross coordinate Y	Y	Y coordinate of measured crosshair
Angle	TH	Angle
Count	CT	Count
Ref. position X	SX	Ref. position X
Ref. position Y	SY	Ref. position Y
Ref. angle	ST	Ref. angle
Cross coordinate XN (N = 0 to 99)	XN	XN coordinate of measured crosshair
Cross coordinate YN (N = 0 to 99)	YN	YN coordinate of measured crosshair
Angle N (N = 0 to 99)	THN	Angle N of measured crosshair

2-10-10 External Reference Tables (Ec Cross)

No.	Data name	Data ident	Set/Get	Data range
0	Judge	judge	Get only	0: No judgment (unmeasured), 1: Judgment result OK, -1: Judgment result NG, -10: Error (image format mismatch), -11: Error (unregistered model), -12: Error (insufficient memory), -20: Error (other errors)
5	Count	crossCount	Get only	0 to 10
6	Cross coordinate X	crossX	Get only	-99,999.9999 to 99,999.9999
7	Cross coordinate Y	crossY	Get only	-99,999.9999 to 99,999.9999
8	Angle	angle	Get only	-45 to 45
9	Reference position X coordinate	referenceX	Get only	-99,999.9999 to 99,999.9999
10	Reference position Y coordinate	referenceY	Get only	-99,999.9999 to 99,999.9999
11	Reference angle	referenceAngle	Get only	-180 to 180
101	Output coordinate	outputCoordinate	Set/Get	0: After scroll, 1: Before scroll
102	Calibration	calibration	Set/Get	0: OFF, 1: ON
103	Reflect to overall judgement	overallJudge	Set/Get	0: ON, 1: OFF
120	Edge extraction level	edgeThresh	Set/Get	0 to 1,000
121	Filter size	maskSize	Set/Get	0: 3x3, 1: 5x5, 2: 7x7, 3: 9x9
122	Lower limit of line length	minExtLength	Set/Get	5 to 4,000
123	Upper limit of line length	maxExtLength	Set/Get	5 to 4,000
124	Combination angle	connectDir	Set/Get	0.0 to 30.0
125	Combination tip distance	connectTipDist	Set/Get	0 to 1,000

No.	Data name	Data ident	Set/Get	Data range
126	Combination seam distance	connectSeamDist	Set/Get	0 to 1,000
127	Lower limit of parallel line 0 length range	minLineLength0	Set/Get	5 to 4,000
128	Upper limit of parallel line 0 length range	maxLineLength0	Set/Get	5 to 4,000
129	Lower limit of parallel line 1 length range	minLineLength1	Set/Get	5 to 4,000
130	Upper limit of parallel line 1 length range	maxLineLength1	Set/Get	5 to 4,000
138	Detection line count	judgeSubline	Set/Get	2 to 4
139	Lower limit of parallel line 0 underrun range	minUnderRun0	Set/Get	0 to 1,000
140	Upper limit of parallel line 0 underrun range	maxUnderRun0	Set/Get	0 to 1,000
141	Lower limit of parallel line 1 underrun range	minUnderRun1	Set/Get	0 to 1,000
142	Upper limit of parallel line 1 underrun range	maxUnderRun1	Set/Get	0 to 1,000
143	Parallel line 0 Min. width	minWidth0	Set/Get	1 to 1,000
144	Parallel line 0 Max. width	maxWidth0	Set/Get	1 to 1,000
145	Parallel line 1 Min. width	minWidth1	Set/Get	1 to 1,000
146	Parallel line 1 Max. width	maxWidth1	Set/Get	1 to 1,000
148	Detection object color	colorObjectBright	Set/Get	0: Both, 1: Dark, 2: Bright
156	Sort condition	sortMode	Set/Get	0: Cross point X, 1: Cross point Y, 2: Length
157	Sort order	sortOperant	Set/Get	0: Ascending, 1: Descending
158	Cross No.	outputNo	Set/Get	0 to 9
162	Fusion distance	margeLength	Set/Get	0 to 1,000
163	Lower limit of cross X	lowerJudgeX	Set/Get	-99,999.9999 to 99,999.9999
164	Upper limit of cross X	upperJudgeX	Set/Get	-99,999.9999 to 99,999.9999
165	Lower limit of cross Y	lowerJudgeY	Set/Get	-99,999.9999 to 99,999.9999
166	Upper limit of cross Y	upperJudgeY	Set/Get	-99,999.9999 to 99,999.9999
167	Lower limit of angle	lowerJudgeAngle	Set/Get	-45 to 45
168	Upper limit of angle	upperJudgeAngle	Set/Get	-45 to 45
169	Lower limit of count	lowerJudgeCross-Count	Set/Get	0 to 10

No.	Data name	Data ident	Set/Get	Data range
170	Upper limit of count	upperJudgeCross-Count	Set/Get	0 to 10
171	Reference position X	referencePosX	Set/Get	0 to 99,999.9999
172	Reference position Y	referencePosY	Set/Get	0 to 99,999.9999
173	Reference angle	referencePosAngle	Set/Get	-180 to 180
174	Line connection level	lineConnectLevel	Set/Get	0: 1, 1: 2, 2: 3, 3: 4, 4: 5, 5: Custom
176	Setting unit of reference coordinate	refUnitNo	Set/Get	-1 to 9,999
177	Setting type of reference coordinate	refSettingType	Set/Get	0: Numerical, 1: Unit
178	Update the reference angle	updateAngleFlg	Set/Get	0: Not update, 1: Update
179	Use point coordinate before scroll	beforeScrollRefMode	Set/Get	0: Not use, 1: Use
180	Reference X before scroll	beforeScrollRefPosX	Set/Get	-99,999.9999 to 99,999.9999
181	Reference Y before scroll	beforeScrollRefPosY	Set/Get	-99,999.9999 to 99,999.9999
182	Angle before scroll	beforeScrollRefAngle	Set/Get	-180 to 180
6,002	Format	cameraColor	Set/Get	1: Monochrome camera 2: Color camera
10,000+N (N=0 to 9)	Cross coordinate X	crossX0 to crossX9	Get only	-99,999.9999 to 99,999.9999
10,100+N (N=0 to 9)	Cross coordinate Y	crossY0 to crossY9	Get only	-99,999.9999 to 99,999.9999
10,200+N (N=0 to 9)	Formed angle	crossAngle0 to crossAngle9	Get only	-45 to 45
90,000	figure0 Count	figArea0_count	Set/Get	0 to 1
90,001	figure0 Type	figArea0_fig0_type	Set/Get	8: Rectangle
90,002	figure0 mode	figArea0_fig0_mode	Set/Get	0: OR
90,014	figure0 Rectangle Upper left position X	figAr- ea0_fig0_box_X0	Set/Get	-99,999 to 99,999
90,015	figure0 Rectangle Upper left position Y	figAr- ea0_fig0_box_Y0	Set/Get	-99,999 to 99,999
90,016	figure0 Rectangle Lower right position X	figAr- ea0_fig0_box_X1	Set/Get	-99,999 to 99,999
90,017	figure0 Rectangle Lower right position Y	figAr- ea0_fig0_box_Y1	Set/Get	-99,999 to 99,999
90,099	figure0 Update	figArea0_update	Set only	1: Update

2-11 Classification

Used in the Following Case

When various kinds of products on a production line need to be classified and identified:

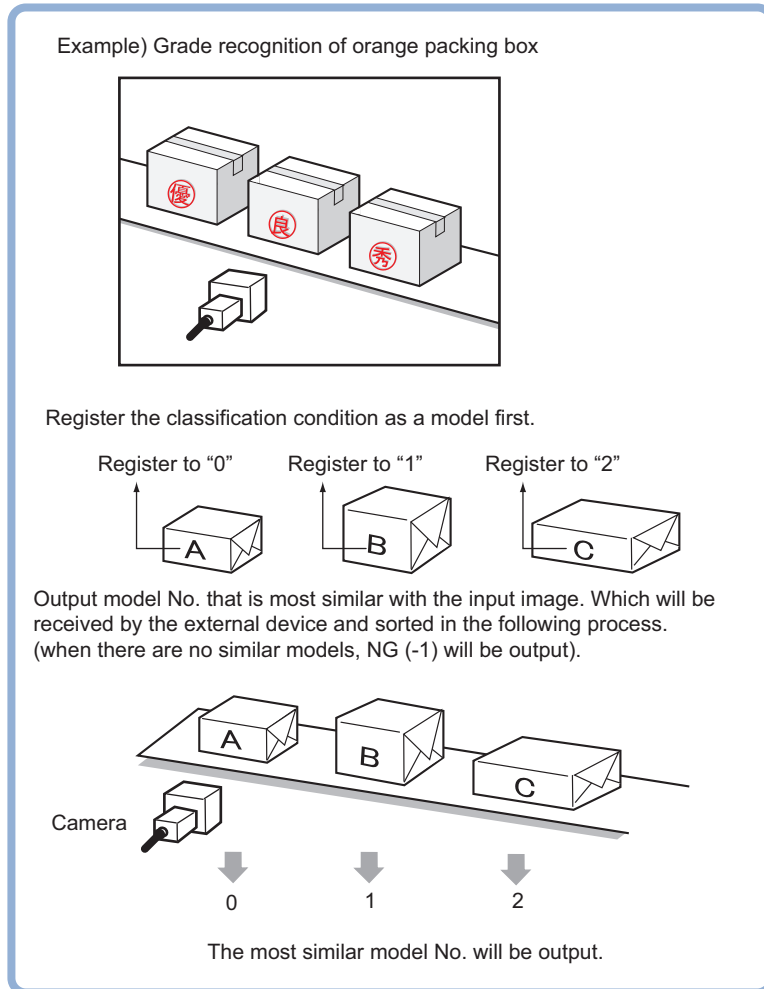

Precautions for Correct Use

Processing is different for color images and monochrome images. When the camera type used in the previous setup was changed to color or monochrome type, perform the settings again.

2-11-1 Settings Flow (Classification)

To set Classification, follow the steps below.

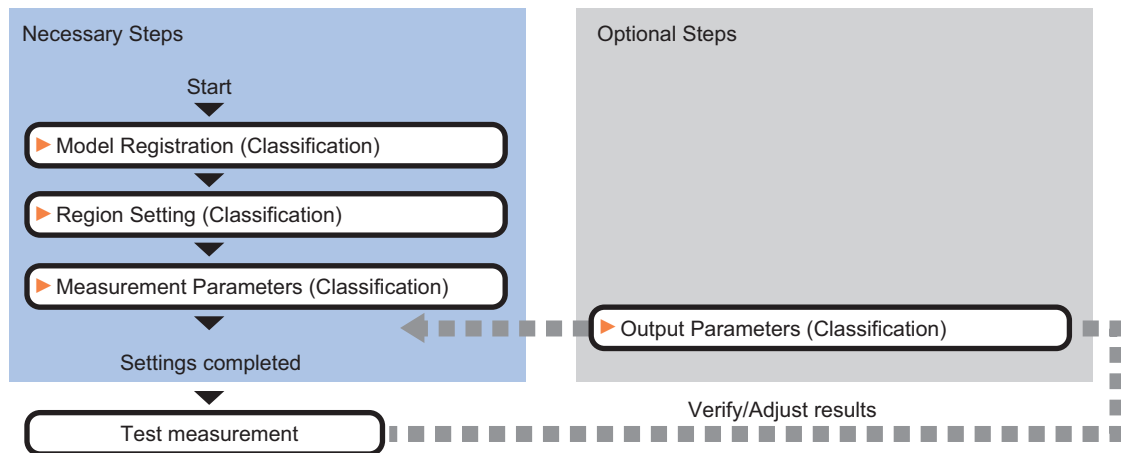

List of Classification Items

Item	Description
Model	This item registers the pattern characteristic of the measurement image as a model. Model parameter values can be changed as needed to address unstable measurement results or to increase the processing speed. Normally, the factory default value will be used. <i>2-11-2 Model Registration (Classification) on page 2-168</i>
Region setting	Sets the measurement area. It is possible to target the entire screen, but restricting the range can shorten the processing time. <i>2-11-3 Region Setting (Classification) on page 2-171</i>
Measurement parameter	Sets processing conditions for measurement and judgment conditions for measurement results. Specify the criteria to judge the measurement result if the X and Y coordinates and the correlation with the model are OK. <i>2-11-4 Measurement Parameters (Classification) on page 2-171</i>
Output parameter	This item can be changed as necessary. Normally, the factory default value will be used. Use the output parameter to specify how to handle the coordinates. <i>2-11-5 Output Parameters (Classification) on page 2-172</i>

2-11-2 Model Registration (Classification)

Pre-register as models the sections to be used as reference for classification.

Models can be registered with any of 200 indexes, from 0 to 199, and up to 5 models can be registered for each index.

When there is variation among the model print quality and shapes, pre-register multiple models for the same index.



Additional Information

Model Status and Measurement Processing

- Measurement time and accuracy may be affected by the status of model in the following ways. Please select measurement objects that are in good condition (clean) for Model Registration.
- In the case of large or complicated models, processing time is prolonged.
- With extremely small models or models without features, search processing is unstable.



Additional Information

When a model is registered, the central coordinates of the model are registered as the detection point. A detection point is a point output as a measurement value. If multiple figures are combined, the central coordinates of the circumscribed rectangle are registered.

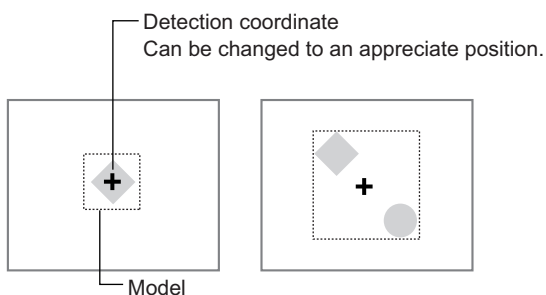

- 1 In the Item tab area, click **Model**.
- 2 In the *Setting model* area, select a model and click **New**.

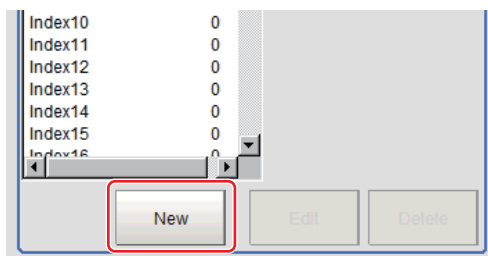

- 3 Use the drawing tools to specify the model registration range.
- 4 Click **OK**.
The model is registered and its central X and Y coordinate values are displayed in the *Setting model* area.

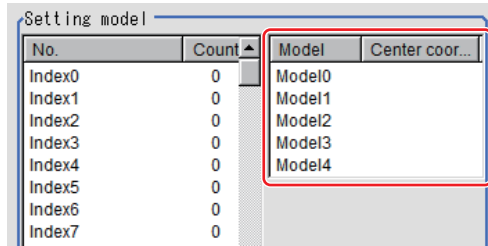

The image specified for the model is displayed in the *Image Display* area.

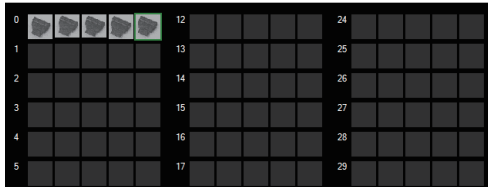

Set the page in the *Switch Page* area to display models with index numbers 36 or more.

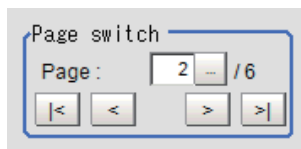

- 5** To register two or more models, repeat step 2 to 4.

Changing Model Parameters

Model parameter values can be changed as needed to address unstable measurement results or to increase the processing speed. Normally, the factory default value will be used.

After changing a setting, re-register the model.

- 1** In the *Model parameter* area, select the *Search mode*, then specify a value for each item for that mode.

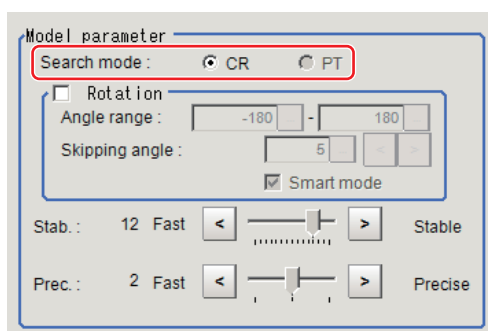

Setting item	Setting value [Factory default]	Description
Search mode	<ul style="list-style-type: none"> • [CR] • PT 	<ul style="list-style-type: none"> • CR: Search for normalizing the brightness. This method can provide stable measurement when there is fluctuation in the overall brightness and when the image has low contrast. • PT: Measures the degree of matching with the profile. This method can measure at higher speed when the rotation angle has a wide range. It is available only when a 0.3 megapixel color camera is connected.

- When CR is selected:

Setting item	Setting value [Factory default]	Description
Rotation	<ul style="list-style-type: none"> • Checked • [Unchecked] 	When the measurement object is rotating, place a check at <i>Rotation</i> and specify how many degrees the model created rotates each time and through what range of angles. A smaller skipping angle increases stability, but slows down the processing. The forward direction is clockwise.
Angle range	-180 to 180 [-180] to [180]	
Skipping angle	1 to 30 [5]	
Smart mode	<ul style="list-style-type: none"> • [Checked] • Unchecked 	Checking the <i>Smart mode</i> option enables a high-speed rotation search. However, the stability may be lowered when the model shape aspect ratio is large or when the NOT mask is used.
Stab.	1 to 15 The default value depend on the connected camera. [9] or [12]	Specify which is to have priority, measurement stability or speed. If lowering stability does not speed up processing, it is likely that many candidates have been detected. In this case, specify a larger value for <i>Candidate LV</i> or <i>Stab.</i> .
Prec.	1 to 3 [2]	Specify which is to have priority, measurement positional precision or speed.

- When PT is selected:

Setting item	Setting value [Factory default]	Description
Angle range	-180 to 180 [-180] to [180]	This item specifies the rotation angle range for searching. The normal direction is clockwise.
Stab.	1 to 5 [3]	If lowering stability does not speed up processing, it is likely that many candidates have been detected. In this case, specify a larger value for <i>Candidate LV</i> or <i>Stab.</i> .

Deleting a Model

Deletes a registered model.

- 1 Select the model from the list and click **Delete**.

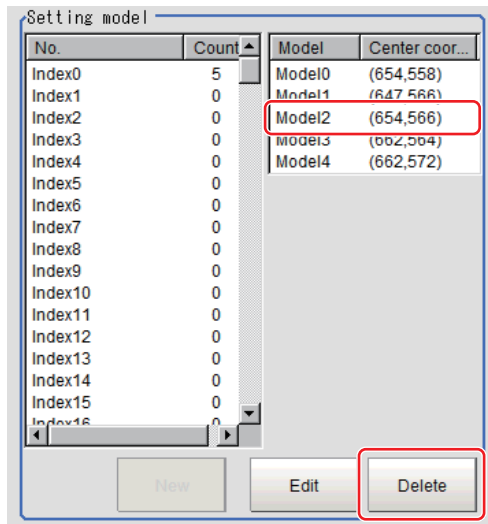

2-11-3 Region Setting (Classification)

Use a rectangle to specify the area where the model is searched.

Instead of measuring the entire input image, narrowing the measurement area shortens the processing time.

- 1 In the Item tab area, click **Region setting**.
- 2 Click **Edit**.
The *Figure Setting* area is displayed.
- 3 Specify the area in which to search for the model.
The rectangle covering the entire screen is set. Adjust the size and position of the rectangle.
- 4 Click **OK** in the *Figure setting* area.
 - **OK**: Changes the settings and returns to the previous menu.
 - **Cancel**: Changes are discarded. Returns to the previous menu.
 - **Apply**: Updates the settings without leaving edit window.

2-11-4 Measurement Parameters (Classification)

Specify the measurement conditions and the judgment conditions for the measurement results of Search.

- 1 In the Item tab area, click **Measurement**.
- 2 In the *Measurement condition* area, specify a value for each item.

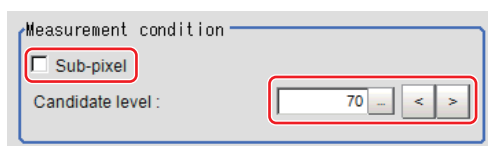

Setting item	Setting value [Factory default]	Description
Sub-pixel	<ul style="list-style-type: none"> • Checked • [Unchecked] 	When a check is placed at <i>sub-pixel</i> , the position information can be measured in units of sub-pixels. However, this requires more processing time.
Candidate LV	0 to 100 [70]	Specify the threshold value with which to detect candidate points in a rough search. Specify a smaller value when model search results are unreliable.

- 3** When the setting has been changed, click **Measure** in the *Detail* area to verify whether measurements can be made correctly.

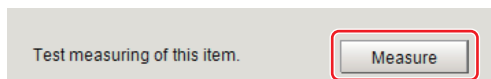

- 4** Set up the judgment condition.



Additional Information

The values beside each item are measurement results of the displayed image. Take these values into consideration to determine the upper and lower limit values.

Setting item	Setting value	Description
Position X	-99,999.9999 to 99,999.9999	Specify the range of X-axis shifting that is judged to be OK.
Position Y	-99,999.9999 to 99,999.9999	Specify the range of Y-axis shifting that is judged to be OK.
Angle θ	-180 to 180	Specify the range of angles that are judged to be OK.
Correlation	0 to 100	Specify the range of correlation values that are judged to be OK. However, when the correlation value of the measurement result is 0, the judgment result will be NG regardless of the lower limit setting.

2-11-5 Output Parameters (Classification)

Specify how to treat the coordinates to be output to the external device as measurement results. This item can be changed if necessary. Normally, the factory default value will be used.



Precautions for Correct Use

After setting up the measurement parameters, changing the output parameters will cause measurement results to vary accordingly. If the output parameters have been changed, re-specify the measurement, too.

- 1** Click **Output parameter** in the Item tab area.
- 2** Specify each of the following items.

Setting item	Setting value [Factory default]	Description
Output coordinates	<ul style="list-style-type: none"> • [After scroll] • Before scroll 	As measurement results, select whether to output coordinate values to external devices before or after the position deflection correction is applied.
Calibration	<ul style="list-style-type: none"> • ON • [OFF] 	Select whether to reflect the calibration in the values output to the external device as measurement results. <ul style="list-style-type: none"> • ON: Output the coordinates converted into actual dimensions. • OFF: Output the camera coordinate values.
Reflect to overall judgment	<ul style="list-style-type: none"> • [ON] • OFF 	Enables choosing whether or not the judgement results of this processing unit is reflected in the scene overall judgment.



Additional Information

For output coordinates and calibration, refer to *Appendixes Measurement Mechanism Handling Coordinates* in the *Vision System FH/FHV Series User's Manual (Cat. No. Z365)*.

2-11-6 Key Points for Test Measurement and Adjustment (Classification)

The following content is displayed in the *Detail result* area as text.

Displayed item	Description
Judge	Judgment results 0: No judgment (unmeasured) 1: Judgment result OK -1: Judgment result NG -10: Error (image format mismatch) -11: Error (unregistered model) -12: Error (insufficient memory) -20: Error (other errors)
Index	Index No. of the highest correlation value
Model No.	Model No. of the highest correlation value
Correlation	Correlation value with the model
Position X	X coordinate of the position where the model is detected.
Position Y	Y coordinate of the position where the model is detected.
Angle θ	Angle of the position where the model is detected.

Key Points for Adjustment (Classification)

Adjust the setting parameters referring to the following points.

● When the judgement is NG (insufficient memory)

Parameter to be adjusted	Remedy
Region setting	Make the search region as small as possible.
Model parameter	Bring <i>Stab.</i> close to the factory default value.
	Bring the <i>Skipping angle</i> close to the factory default value.
	Specify a smaller value for <i>Prec.</i>

● When searching other positions

Parameter to be adjusted	Remedy
Model parameter	Specify a larger value for the <i>Prec.</i>
	If the measurement results are unstable only when <i>Rotation</i> is selected, specify a smaller value for the <i>Skipping angle</i> .
	When <i>Rotation</i> is selected, if the model shape is complex, uncheck the <i>Smart mode</i> option.
	If the image has low contrast or blurred edges, set the <i>Search mode</i> to <i>CR</i> .
	If the model image consists of detailed figures, specify a larger value for <i>Stab.</i>
Measurement parameter	If the precision is low, place a check at <i>Sub-pixel</i> .
	If images that should be judged OK vary greatly, specify a smaller value for <i>Candidate LV</i> .
	Specify a smaller value for the <i>Reduction</i> when the model image is small and unstable.

● When the processing speed is slow

Parameter to be adjusted	Remedy
Region setting	Make the search region as small as possible.
	Make the area to register as the model as small as possible.
	If the model image is a simple figure or a large figure, specify a smaller value for <i>Stab</i> .
	If lowering stability does not speed up processing, it is likely that many candidates have been detected. Raise the <i>Candidate LV</i> in <i>Measurement</i> .
	When <i>Rotation</i> is selected and the model image is a simple figure, specify a larger value for the <i>Skipping angle</i> .
	When <i>Rotation</i> is selected and the model image is a simple figure, place a check at the <i>Smart mode</i> .
	If the position precision is high, specify a smaller value for <i>Prec</i> .
Measurement parameter	If the rotation angle range is large, set the <i>Search mode</i> to <i>PT</i> .
	If images that should be judged OK vary little, specify a larger value for <i>Candidate LV</i> .
	If the position precision is high, uncheck <i>Sub-pixel</i> .

2-11-7 Measurement Results for Which Output Is Possible (Classification)

The following values can be output using processing items related to result output. It is also possible to reference measurement values from calculation expressions and other processing units.

Measurement items	Character string	Description
Judge	JG	Judgment results 0: No judgment (unmeasured) 1: Judgment result OK -1: Judgment result NG -10: Error (image format mismatch) -11: Error (unregistered model) -12: Error (insufficient memory) -20: Error (other errors)
Index	IN	Index No. of the highest correlation value
Model No.	NO	Model No. of the highest correlation value
Correlation	CR	Correlation value with the model
Position X	X	X coordinate of the position where the model is detected.
Position Y	Y	Y coordinate of the position where the model is detected.
Angle θ	TH	Angle of the position where the model is detected.
Ref. position X	SX	X coordinate of the reference position of the registered model
Ref. position Y	SY	Y coordinate of the reference position of the registered model
Detection point RX	RX	X coordinate of detection point set when model was registered
Detection point RY	RY	Y coordinate of detection point set when model was registered

2-11-8 External Reference Tables (Classification)

No.	Data name	Data ident	Set/Get	Data range
0	Judge	judge	Get only	0: No judgment (unmeasured), 1: Judgment result OK, -1: Judgment result NG, -10: Error (image format mismatch), -11: Error (unregistered model), -12: Error (insufficient memory), -20: Error (other errors)
5	Index	indexNo	Get only	-1: No models found 0 to 199
6	Model No.	modelNo	Get only	-1: No models found 0 to 4
7	Correlation value	correlation	Get only	0 to 100
8	Measure X	x	Get only	-99,999.9999 to 99,999.9999
9	Measure Y	y	Get only	-99,999.9999 to 99,999.9999
10	Angle theta	angle	Get only	-180 to 180
11	Reference X	referenceX	Get only	-99,999.9999 to 99,999.9999
12	Reference Y	referenceY	Get only	-99,999.9999 to 99,999.9999
13	Reference angle theta	referenceAngle	Get only	-180 to 180
14	Detected coordinate X	detectionX	Get only	-99,999.9999 to 99,999.9999
15	Detected coordinate Y	detectionY	Get only	-99,999.9999 to 99,999.9999
101	Output coordinates	outputCoordinate	Set/Get	0: After scroll, 1: Before scroll
102	Calibration	calibration	Set/Get	0: OFF, 1: ON
103	Reflect to overall judgement	overallJudge	Set/Get	0: ON, 1: OFF
120	Search mode	searchMode	Set/Get	0: Correlation, 1: Shape
121	With rotation	rotation	Set/Get	0: OFF, 1: ON
122	Upper limit of the rotation angle	endAngle	Set/Get	-180 to 180
123	Lower limit of the rotation angle	startAngle	Set/Get	-180 to 180
124	Skipping angle	angleSkip	Set/Get	1 to 30
125	Smart mode	smartMode	Set/Get	0: OFF, 1: ON
126	Stab.(CR)	stability	Set/Get	1 to 15
127	Prec.	accuracy	Set/Get	1 to 3
128	Stab.(SH)	searchSpeed	Set/Get	1 to 5
134	Sub-pixel	subPixel	Set/Get	0: OFF, 1: ON
135	Candidate Point Level	candidateLevel	Set/Get	0 to 100
136	Upper limit of measure X	upperX	Set/Get	-99,999.9999 to 99,999.9999
137	Lower limit of measure X	lowerX	Set/Get	-99,999.9999 to 99,999.9999

No.	Data name	Data ident	Set/Get	Data range
138	Upper limit of measure Y	upperY	Set/Get	-99,999.9999 to 99,999.9999
139	Lower limit of measure Y	lowerY	Set/Get	-99,999.9999 to 99,999.9999
140	Upper limit of the angle	upperAngle	Set/Get	-180 to 180
141	Lower limit of the angle	lowerAngle	Set/Get	-180 to 180
142	Upper limit of the corr.	upperCorrelation	Set/Get	0 to 100
143	Lower limit of the corr.	lowerCorrelation	Set/Get	0 to 100
6,002	Format	cameraColor	Set/Get	1: Monochrome camera 2: Color camera
90,000	figure0 Count	figArea0_count	Set/Get	1
90,001	figure0 Type	figArea0_fig0_type	Set/Get	8: Rectangle
90,002	figure0 mode	figArea0_fig0_mode	Set/Get	0: OR
90,014	figure0 Rectangle Upper left position X	figArea0_fig0_box_X0	Set/Get	-99,999 to 99,999
90,015	figure0 Rectangle Upper left position Y	figArea0_fig0_box_Y0	Set/Get	-99,999 to 99,999
90,016	figure0 Rectangle Lower right position X	figArea0_fig0_box_X1	Set/Get	-99,999 to 99,999
90,017	figure0 Rectangle Lower right position Y	figArea0_fig0_box_Y1	Set/Get	-99,999 to 99,999
90,099	figure0 Update	figArea0_update	Set only	1: Update

2-12 Edge Position

This processing item detects the position of the measurement object by using the change in color within the measurement region.

Used in the Following Case

- To calculate edge coordinates of measurement objects:

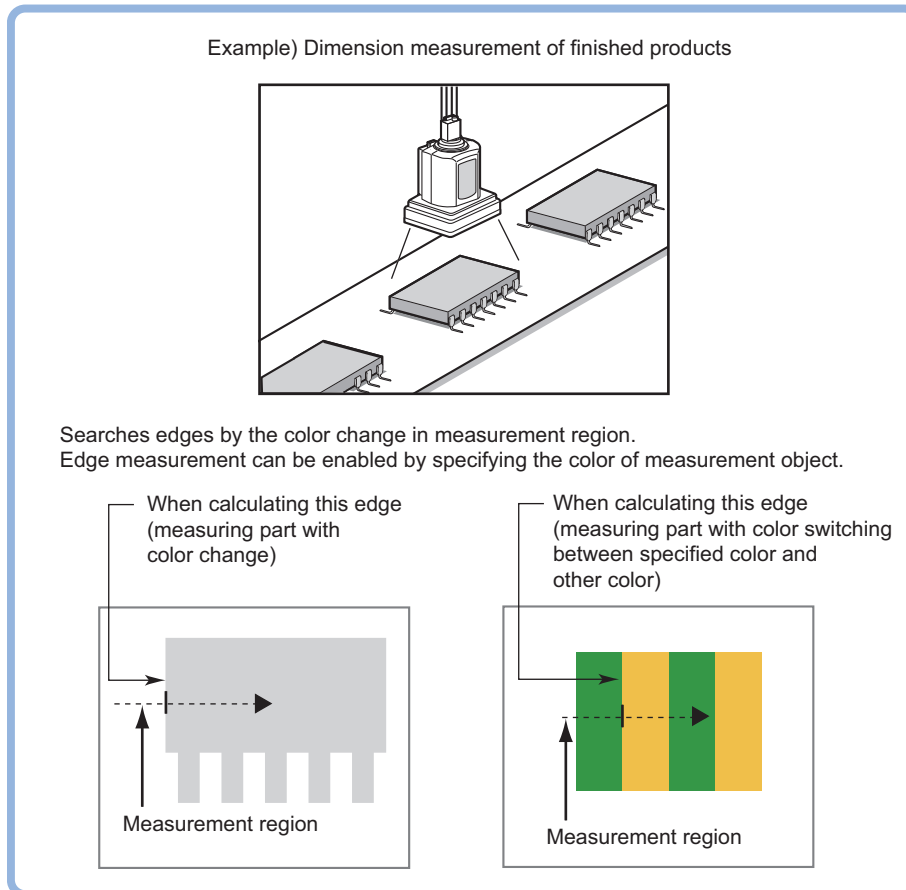

- To find the width of a measurement object
Using an expression, the width of a measurement object can be calculated from the difference between two edge positions.



Precautions for Correct Use

Processing is different for color images and monochrome images. When the camera type used in the previous setup was changed to color or monochrome type, perform the settings again.



Additional Information

Edge processing basic concepts:

For details, refer to *Appendixes Measurement Mechanism Edge Detection Measurement* in the *Vision System FH/FHV Series User's Manual (Cat. No. Z365)*.

2-12-1 Settings Flow (Edge Position)

To set Edge Position, follow the steps below.

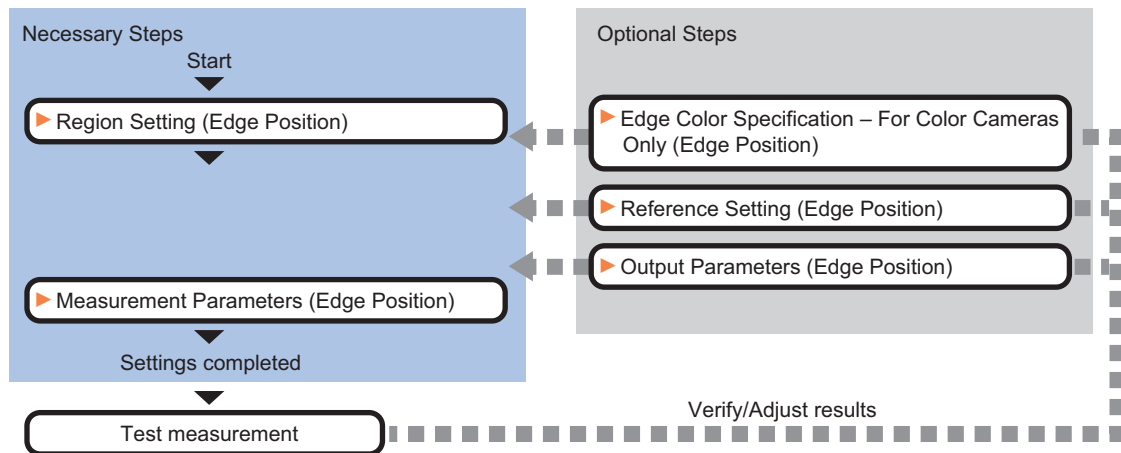

List of Edge Position Items

Item	Description
Region setting	Sets the measurement area. <i>2-12-2 Region Setting (Edge Position) on page 2-180</i>
Edge color (for color cameras only)	This item selects the color of the edges to be detected. If the target color changes, this setting is not necessary. If the color is not specified, positions in the measurement region where the color changes drastically are detected as an edge. <i>2-12-3 Edge Color Specification - For Color Cameras Only (Edge Position) on page 2-181</i>
Ref. setting	This item can be changed as necessary. Specify the reference position within the camera's field of view. <i>2-12-4 Reference Setting (Edge Position) on page 2-182</i>
Measurement parameter	Sets processing conditions for measurement and judgment conditions for measurement results. Measurement parameter can be changed as needed to address unstable measurement results. The displayed items depend on whether your camera is a color or monochrome camera. Normally, the factory default value will be used. <i>2-12-5 Measurement Parameters (Edge Position) on page 2-184</i>
Output parameter	This item can be changed as necessary. Normally, the factory default value will be used. Use the output parameter to specify how to handle the coordinates. <i>2-12-6 Output Parameters (Edge Position) on page 2-187</i>

2-12-2 Region Setting (Edge Position)

This item is used to set up the measurement area.

Use a straight line (arrow), circumference, or arc to specify a measurement region for *Edge position*.



Additional Information

- The edge is scanned from the start point of the area toward the end point. When setting up the measurement region, pay attention to the detection direction of the edge.

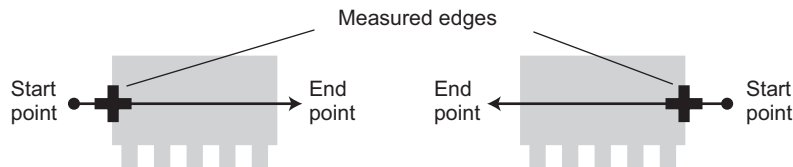

Drawing the line from left to right and from right to left will lead to different measured edges.

- Measurement cannot be performed if there is no edge within the measurement region. When determining the size and position of the measurement region, take into account the movement range of the measurement object.

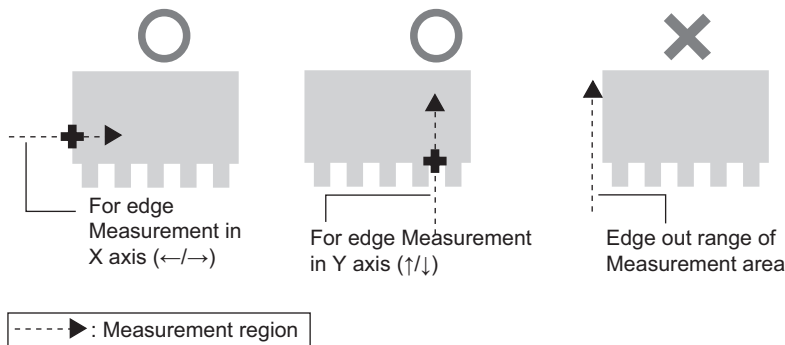

- In the Item tab area, click **Region setting**.
- Use the drawing tools to set the measurement region.
- Click **OK** in the *Figure setting* area.
 - OK**: Changes the settings and returns to the previous menu.
 - Cancel**: Changes are discarded. Returns to the previous menu.
 - Apply**: Updates the settings without leaving edit window.



Additional Information

Use the zoom function if the measurement region is too small to identify the direction of the arrow.

For details, refer to *Appendixes Measurement Mechanism Edge Detection Measurement* in the *Vision System FH/FHV Series User's Manual (Cat. No. Z365)*.

- When a circumference or arc is selected as the registered figure, select the edge search direction.

If a check is placed at the *Circle/Arc with width counterclockwise* option, the edge is searched counterclockwise. If this option is unchecked, the edge is searched clockwise.

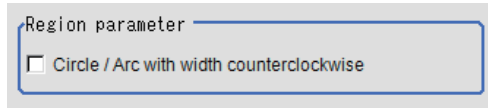

2-12-3 Edge Color Specification - For Color Cameras Only (Edge Position)

This item selects the color of the edges to be detected.

If the target color changes, this setting is not necessary. If the color is not specified, positions in the measurement region where the color changes drastically are detected as an edge.

- 1 In the Item tab area, click **Edge color**.
- 2 Place a check at *Edge color specification* in the *Color setting* area.

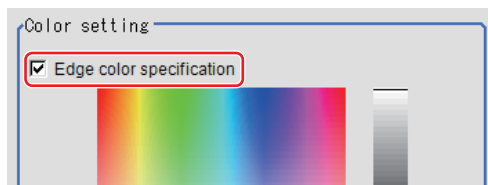

- 3 Select the color to detect as edges.

Setting item	Setting value [Factory default]	Description
Image Display area	-	Specify a region on the image that includes the target color. The average color of the specified region is registered.
Color chart	-	Click the reference color on the color chart to specify it. The RGB values for the specified color are displayed at the bottom.
R, G, B	0 to 255 [255]	The color to be detected is set with the RGB values.
Difference R, G, B	0 to 127 [5]	This sets the allowable color difference for detecting the edge, using the specified color as the reference. The larger the difference values, the larger the color range that is used to detect the edge.

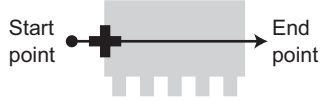
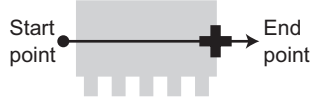
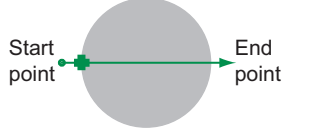
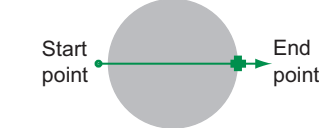
Setting item	Setting value [Factory default]	Description
Detection mode	<ul style="list-style-type: none"> [Color IN] Color OUT 	<ul style="list-style-type: none"> Color IN: The position where a color other than the specified color changes to the specified color is detected as the edge. Color OUT: The position where the specified color changes to a color other than the specified color is detected as the edge. <div style="display: flex; justify-content: space-around; align-items: flex-start;"> <div style="text-align: center;">  <p>For "Color IN" edge measurement mode</p> </div> <div style="text-align: center;">  <p>For "Color OUT" edge measurement mode</p> </div> </div> <div style="display: flex; justify-content: space-around; align-items: flex-start; margin-top: 20px;"> <div style="text-align: center;">  <p>For "Color IN" edge measurement mode</p> </div> <div style="text-align: center;">  <p>For "Color OUT" edge measurement mode</p> </div> </div>

2-12-4 Reference Setting (Edge Position)

When the model is set, this position is automatically set at the same time as the reference position. This item can be set to change the reference position to any desired position. This is handy for measuring the position deviation from a certain position. A reference position can be set either directly or by referencing a unit.

Specifying Directly

Click a position on the image you want to use as a reference position, or input coordinate data for that point.

- 1 In the Item tab area, click **Ref. setting**.
In the *Display* area, the current reference position will be displayed as the crosshair cursor.

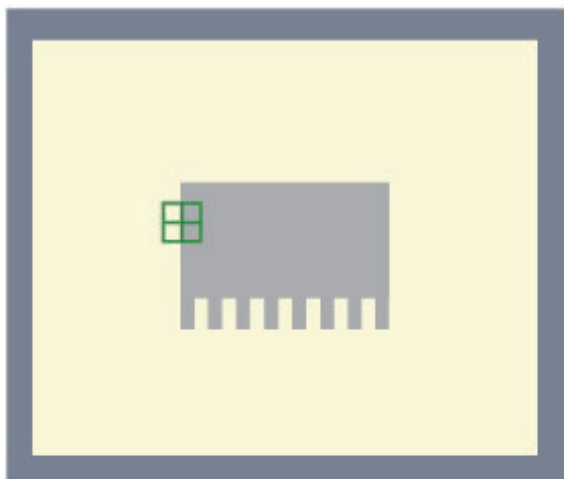

- 2 In the *Method* area, select *Numerical*.

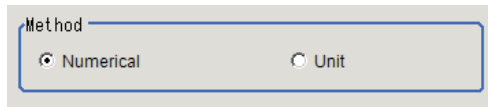

- 3 Click the position to be set as the reference.



Additional Information

Displaying the image enlarged makes this clicking easier.
For details, refer to *Appendixes Basic Knowledge about Operations Using the Zoom Function in the Vision System FH/FHV Series User's Manual* (Cat. No. Z365).

- 4 Make fine adjustments using numeric value inputs or the arrow buttons as required.

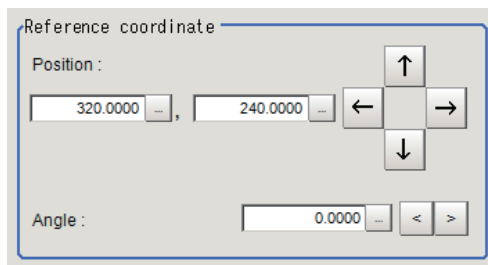

- 5 Set the reference angle with a numeric value.

- 6 To remeasure on the displayed image and set the reference, click **Measure ref.**.
To update the reference angle at the time of reference measurement, place a check at *Update the angle when measure ref.*

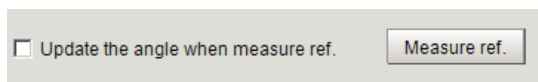

- 7 To use data before position compensation for the reference setting coordinates, place a check at *Use point coordinate before scroll*.

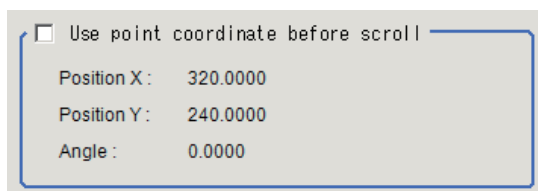

Precautions for Correct Use

If you check *Use point coordinate before scroll*, do not use the following processing items. Otherwise, correct search results cannot be obtained.

- Precise Calibration
- Calibration Data Reference

Referencing a Unit

Set a reference by referencing a detection point unit with registered X coordinate, Y coordinate and angle data.

- 1 In the Item tab area, click **Ref. setting**.
In the *Display* area, the current reference position will be displayed as the crosshair cursor.
- 2 In the *Method* area, select *Unit*.

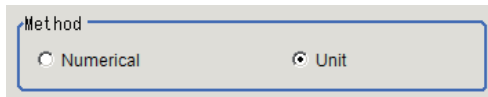

- 3 In the *Unit* area, select a detection point unit in the scene.

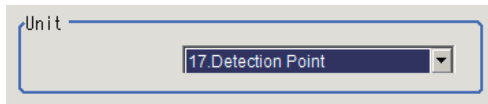

Performing the next measurement will display the reference.

2-12-5 Measurement Parameters (Edge Position)

This item specifies the judgment condition for measurement results. Measurement parameter can be changed as needed to address unstable measurement results.



Additional Information

When the region is a circumference or arc, you can display the graph enlarged in the vertical direction. Place a check at *Zoom* and click the button to adjust.

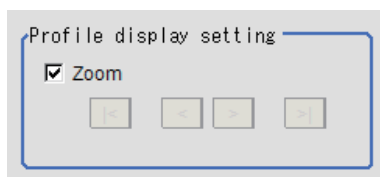

- 1 In the Item tab area, click **Measurement**.
The edge profile of the measurement region is displayed as a graph in the *Image Display* area.

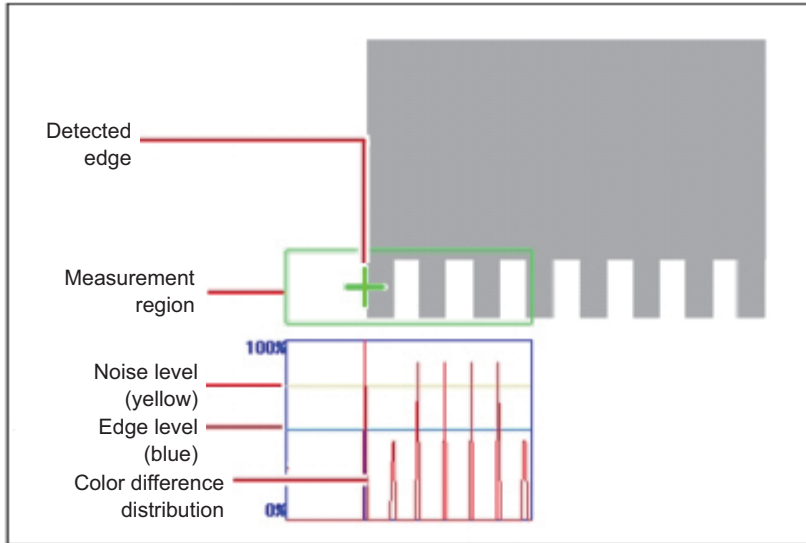

2 If necessary, specify a value for each item in the *Measurement condition* area.

- For color cameras:

Edge Color Not Specified

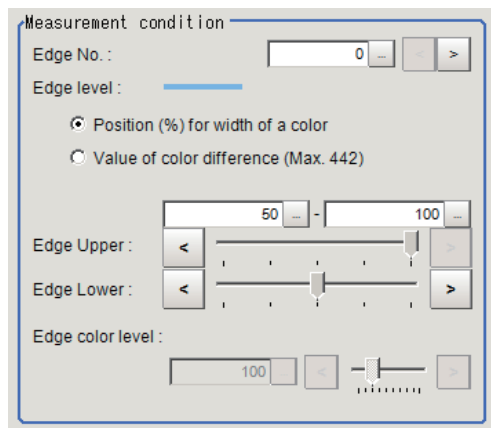

Edge Color Specified

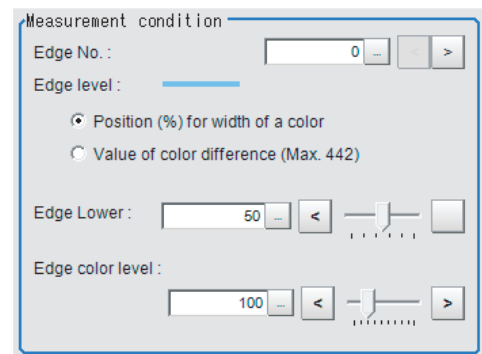

Setting item	Setting value [Factory default]	Description
Edge No.	0 to 99 [0]	Specify the edge number used to extract edges. <i>Edge numbers</i> are assigned to detected edges starting from 0 and going on in the direction from the start point (the arrow point) to the end point (the direction of arrow) in the selected area.
Edge Upper (only when edge color is not specified) Edge Lower	<ul style="list-style-type: none"> • Position (%) for width of a color 0 to 100 [50] to [100] • Value of color 0 to 442 [20] to [442] 	Set a range of a color difference level with which the edge is detected. For details, refer to <i>Appendixes Measurement Mechanism Edge Detection Measurement</i> in the <i>Vision System FH/FHV Series User's Manual (Cat. No. Z365)</i> .
Edge color level	0 to 442 [100]	This emphasis level can be specified only if the edge color to detect is specified.

- For monochrome cameras:

When the *Measurement type* is *Projection*:

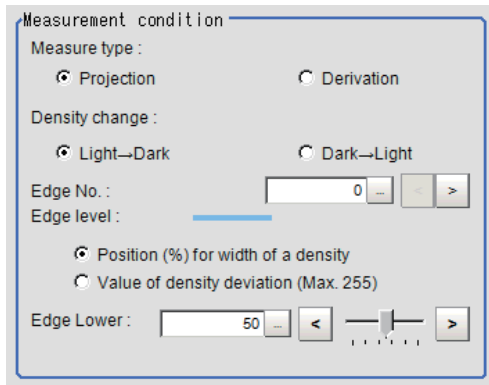

When the *Measurement type* is *Derivation*:

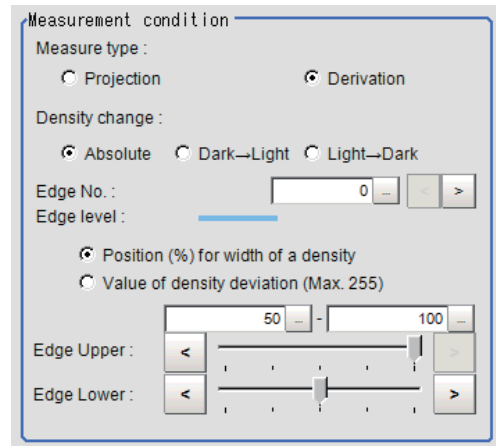

Setting item	Setting value [Factory default]	Description
Measure type	<ul style="list-style-type: none"> [Projection] Derivation 	As the <i>Measurement type</i> , specify either <i>Projection</i> or <i>Derivation</i> . For details, refer to <i>Appendixes Measurement Mechanism Edge Detection Measurement</i> in the <i>Vision System FH/FHV Series User's Manual (Cat. No. Z365)</i> .
Density change	<ul style="list-style-type: none"> Absolute (only when the <i>Measure type</i> is <i>Derivation</i>) [Dark → Light] Light → Dark 	Select whether a black-to-white change or a white-to-black change should be recognized as a density change in the specified region.
Edge No.	0 to 99 [0]	Specify the edge number used to extract edges. <i>Edge numbers</i> are assigned to detected edges starting from 0 and going on in the direction from the start point (the arrow point) to the end point (the direction of arrow) in the selected area.
Edge Upper Edge Lower	<ul style="list-style-type: none"> Position (%) for width of a density 0 to 100 [50] to [100] Value of density 0 to 255 [20] to [255] 	Select the density change level to be detected as edges. The upper limit of edges can be set only when the <i>Measure type</i> is <i>Derivation</i> . For details, refer to <i>Appendixes Measurement Mechanism Edge Detection Measurement</i> in the <i>Vision System FH/FHV Series User's Manual (Cat. No. Z365)</i> .

3 If necessary, set each item in the *Noise removal* area.

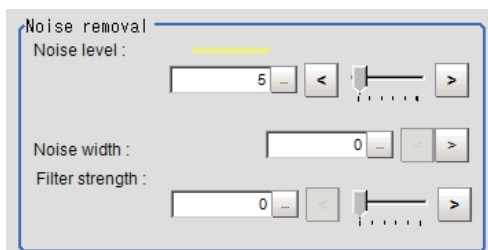

Setting item	Setting value [Factory default]	Description
Noise level	<ul style="list-style-type: none"> For color cameras: 0 to 442 [5] For monochrome cameras: 0 to 255 [5] 	When edges are incorrectly detected due to noise, increase this value. For details, refer to <i>Appendixes Measurement Mechanism Edge Detection Measurement</i> in the <i>Vision System FH/FHV Series User's Manual (Cat. No. Z365)</i> .
Noise width	0 to 9,999 [0]	Set the width for judging noise. When detection is affected by noise, increase this value. For details, refer to <i>Appendixes Measurement Mechanism Edge Detection Measurement</i> in the <i>Vision System FH/FHV Series User's Manual (Cat. No. Z365)</i> .
Filter strength	0 to 100 [0]	If a valley appears in the histogram around the edge threshold value due to noises, smoothen the edge profile using a filter to prevent wrong error detection from being detected. Strengthening the filter smoothen the edge profile further.

- 4** When the setting has been changed, click **Measure** in the *Detail* area to verify whether measurements can be made correctly.

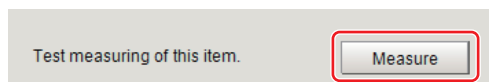

- 5** Set up the judgment condition.



Additional Information

The values beside each item are measurement results of the displayed image. Take these values into consideration to determine the upper and lower limit values.

Setting item	Setting value	Description
Edge position X	-99,999.9999 to 99,999.9999	Specify the range of X-axis shifting that is judged to be OK.
Edge position Y	-99,999.9999 to 99,999.9999	Specify the range of Y-axis shifting that is judged to be OK.

2-12-6 Output Parameters (Edge Position)

Specify how to treat the coordinates to be output to the external device as measurement results. This item can be changed if necessary. Normally, the factory default value will be used.



Precautions for Correct Use

After setting up the measurement parameters, changing the output parameters will cause measurement results to vary accordingly. If the output parameters have been changed, re-specify the measurement, too.

- 1** Click **Output parameter** in the Item tab area.

2 Specify each of the following items.

Setting item	Setting value [Factory default]	Description
Output coordinates	<ul style="list-style-type: none"> • [After scroll] • Before scroll 	As measurement results, select whether to output coordinate values to external devices before or after the position deflection correction is applied.
Calibration	<ul style="list-style-type: none"> • ON • [OFF] 	Select whether to reflect the calibration in the values output to the external device as measurement results. <ul style="list-style-type: none"> • ON: Output the coordinates converted into actual dimensions. • OFF: Output the camera coordinate values.
Reflect to overall judgment	<ul style="list-style-type: none"> • [ON] • OFF 	Enables choosing whether or not the judgement results of this processing unit is reflected in the scene overall judgment.



Additional Information

For output coordinates and calibration, refer to *Appendixes Measurement Mechanism Handling Coordinates* in the *Vision System FH/FHV Series User's Manual (Cat. No. Z365)*.

2-12-7 Key Points for Test Measurement and Adjustment (Edge Position)

The following content is displayed in the *Detail result* area as text.

Displayed item	Description
Judge	Judgment results 0: No judgment (unmeasured) 1: Judgment result OK -1: Judgment result NG -10: Error (image format mismatch) -11: Error (unregistered model) -12: Error (insufficient memory) -20: Error (other errors)
Edge position X	X coordinate of the measured edge position
Edge position Y	Y coordinate of the measured edge position

The image specified in the Sub-image number in the image display setting is displayed in the *Image Display* area.

Sub-image number	Description of image to be displayed
0	Measurement image
1	Profile display

Key Points for Adjustment (Edge Position)

Adjust the setting parameters referring to the following points.

● When the measurement results are unstable

Parameter to be adjusted	Remedy
Measurement parameter	When the color of the edges to be detected is decided, specify the color with <i>Edge color</i> . If results are not stable even with the color specified, specify a larger value for the color variance range.
	If noise is detected as an edge, specify larger values for <i>Noise level</i> and <i>Noise width</i> .

2-12-8 Measurement Results for Which Output Is Possible (Edge Position)

The following values can be output using processing items related to result output. It is also possible to reference measurement values from calculation expressions and other processing units.

Measurement items	Character string	Description
Judge	JG	Judgment results 0: No judgment (unmeasured) 1: Judgment result OK -1: Judgment result NG -10: Error (image format mismatch) -11: Error (unregistered model) -12: Error (insufficient memory) -20: Error (other errors)
Edge position X	X	X coordinate of the measured edge position
Edge position Y	Y	Y coordinate of the measured edge position
Ref. position X	SX	Ref. position X
Ref. position Y	SY	Ref. position Y

2-12-9 External Reference Tables (Edge Position)

No.	Data name	Data ident	Set/Get	Data range
0	Judge	judge	Get only	0: No judgment (unmeasured), 1: Judgment result OK, -1: Judgment result NG, -10: Error (image format mismatch), -11: Error (unregistered model), -12: Error (insufficient memory), -20: Error (other errors)
5	Edge position X	positionX	Get only	-99,999.9999 to 99,999.9999
6	Edge position Y	positionY	Get only	-99,999.9999 to 99,999.9999
7	Reference X	referenceX	Get only	-99,999.9999 to 99,999.9999
8	Reference Y	referenceY	Get only	-99,999.9999 to 99,999.9999
101	Output coordinates	outputCoordinate	Set/Get	0: After scroll, 1: Before scroll
102	Calibration	calibration	Set/Get	0: OFF, 1: ON
103	Reflect to overall judgement	overallJudge	Set/Get	0: ON, 1: OFF

No.	Data name	Data ident	Set/Get	Data range
120	Edge color specification	colorSpecification	Set/Get	0: OFF, 1: ON
121	Edge color R	colorR	Set/Get	0 to 255
122	Edge color G	colorG	Set/Get	0 to 255
123	Edge color B	colorB	Set/Get	0 to 255
124	Difference R	colorDevR	Set/Get	0 to 127
125	Difference G	colorDevG	Set/Get	0 to 127
126	Difference B	colorDevB	Set/Get	0 to 127
127	Edge detection mode	detectionMode	Set/Get	0: Color IN, 1: Color OUT
129	Reference X	referencePosX	Set/Get	0 to 99,999.9999
130	Reference Y	referencePosY	Set/Get	0 to 99,999.9999
131	Edge No.	edgeNo	Set/Get	0 to 99
132	Edge Level Lower limit	edgeLevel	Set/Get	0 to 100
133	Noise level	noiseLevel	Set/Get	Color camera: 0 to 442 Monochrome camera: 0 to 255
134	Noise width	noiseWidth	Set/Get	0 to 9,999
135	Edge color level	colorLevel	Set/Get	0 to 442
136	Upper limit of the edge position X	upperX	Set/Get	-99,999.9999 to 99,999.9999
137	Lower limit of the edge position X	lowerX	Set/Get	-99,999.9999 to 99,999.9999
138	Upper limit of the edge position Y	upperY	Set/Get	-99,999.9999 to 99,999.9999
139	Lower limit of the edge position Y	lowerY	Set/Get	-99,999.9999 to 99,999.9999
140	Monochrome Projection edge detection mode	monoDetectMode	Set/Get	0: Light → Dark 1: Dark → Light
141	Edge level Lower limit absolute value	edgeLevelAbs	Set/Get	Color camera: 0 to 442 Monochrome camera: 0 to 255
142	Edge level specification method	edgeLevelKind	Set/Get	0: %, 1: Absolute value
143	Clockwise/Counterclockwise	counterclockwise	Set/Get	0: Clockwise 1: Counterclockwise
144	Measure type	measureType	Set/Get	0: Projection, 1: Derivation
145	Monochrome Derivation edge detection mode	diffDetectMode	Set/Get	0: Absolute, 1: Dark → Light, 2: Light → Dark
146	Edge Level Upper limit	edgeLevelUpper	Set/Get	0 to 100
147	Edge level Upper limit absolute value	edgeLevelUpperAbs	Set/Get	Color camera: 0 to 442 Monochrome camera: 0 to 255
148	Filter Strength	filterStrength	Set/Get	0 to 100
158	Setting unit of reference coordinate	refUnitNo	Set/Get	-1 to 9,999

No.	Data name	Data ident	Set/Get	Data range
159	Setting type of reference coordinate	refSettingType	Set/Get	0: Numerical, 1: Unit
160	Use point coordinate before scroll	beforeScrollRefMode	Set/Get	0: Not use, 1: Use
161	Reference X before scroll	beforeScrollRefPosX	Set/Get	-99,999.9999 to 99,999.9999
162	Reference Y before scroll	beforeScrollRefPosY	Set/Get	-99,999.9999 to 99,999.9999
6,002	Format	cameraColor	Set/Get	1: Monochrome camera 2: Color camera
90,000	figure0 Count	figArea0_count	Set/Get	0 to 1
90,001	figure0 Type	figArea0_fig0_type	Set/Get	4: Wide line, 64: Circumference, 256: Wide arc
90,002	figure0 mode	figArea0_fig0_mode	Set/Get	0: OR
90,009	figure0 Wide line Start point X	figAr- ea0_fig0_lineW_X0	Set/Get	-99,999 to 99,999
90,010	figure0 Wide line Start point Y	figAr- ea0_fig0_lineW_Y0	Set/Get	-99,999 to 99,999
90,011	figure0 Wide line End point X	figAr- ea0_fig0_lineW_X1	Set/Get	-99,999 to 99,999
90,012	figure0 Wide line End point Y	figAr- ea0_fig0_lineW_Y1	Set/Get	-99,999 to 99,999
90,013	figure0 Wide line Width	figAr- ea0_fig0_lineW_W	Set/Get	0 to 99,999
90,025	figure0 Circumference Center Position X	figArea0_fig0_circleW_X	Set/Get	-99,999 to 99,999
90,026	figure0 Circumference Center Position Y	figArea0_fig0_circleW_Y	Set/Get	-99,999 to 99,999
90,027	figure0 Circumference Radius	figArea0_fig0_circleW_R	Set/Get	0 to 99,999
90,028	figure0 Circumference Width	figArea0_fig0_circleW_W	Set/Get	0 to 99,999
90,034	figure0 Wide arc Center Position X	figAr- ea0_fig0_arcW_X	Set/Get	-99,999 to 99,999
90,035	figure0 Wide arc Center Position Y	figAr- ea0_fig0_arcW_Y	Set/Get	-99,999 to 99,999
90,036	figure0 Wide arc Radius	figAr- ea0_fig0_arcW_R	Set/Get	0 to 99,999
90,037	figure0 Wide arc Start angle	figAr- ea0_fig0_arcW_SA	Set/Get	-180 to 180
90,038	figure0 Wide arc End angle	figAr- ea0_fig0_arcW_EA	Set/Get	-180 to 180
90,039	figure0 Wide arc Width	figAr- ea0_fig0_arcW_W	Set/Get	0 to 99,999
90,099	figure0 Update	figArea0_update	Set only	1: Update

2-13 Edge Pitch

Finds and counts the edges by measuring the color change within the measurement region.

Used in the Following Case

- When calculating the number of pins of IC or connectors:

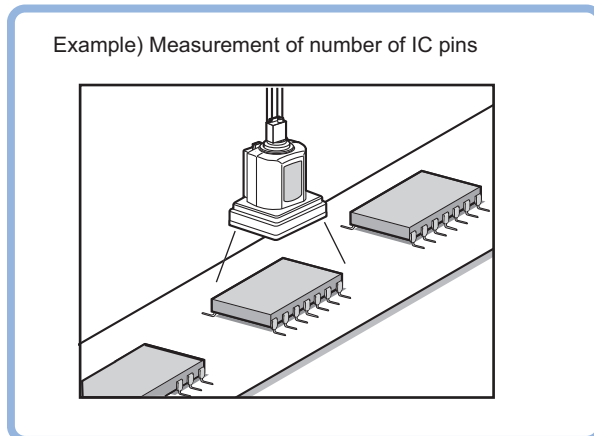

- When calculating the pin width and the distance (pitch) between midpoints:

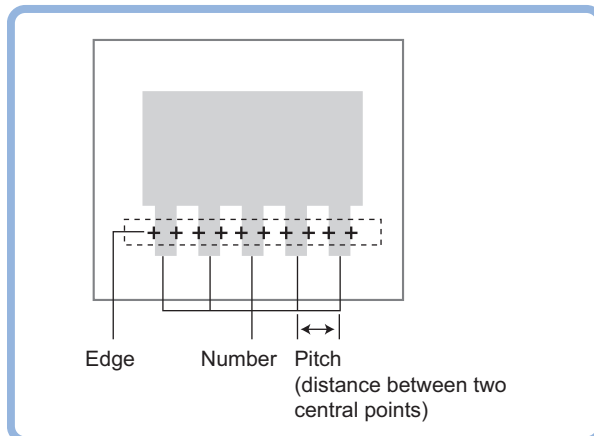

Precautions for Correct Use

Processing is different for color images and monochrome images. When the camera type used in the previous setup was changed to color or monochrome type, perform the settings again.



Additional Information

Edge processing basic concepts:

For details, refer to *Appendixes Measurement Mechanism Edge Detection Measurement* in the *Vision System FH/FHV Series User's Manual (Cat. No. Z365)*.

2-13-1 Settings Flow (Edge Pitch)

To set Edge Pitch, follow the steps below.

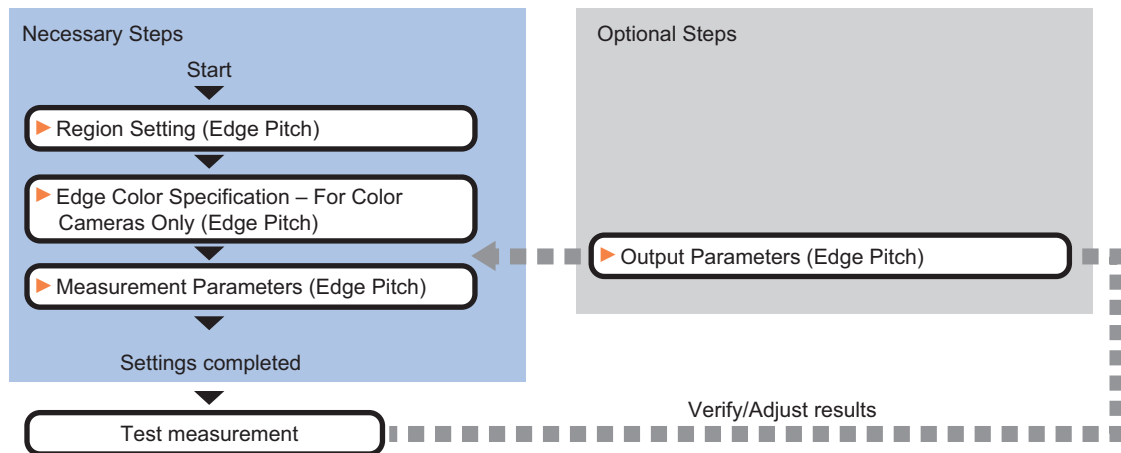

Item List for Edge Pitch

Item	Description
Region setting	Sets the measurement area. <i>2-13-2 Region Setting (Edge Pitch) on page 2-194</i>
Edge color (for color cameras only)	This item selects the color of the edges to be detected. If the target color changes, this setting is not necessary. If the color is not specified, positions in the measurement region where the color changes drastically are detected as an edge. <i>2-13-3 Edge Color Specification - For Color Cameras Only (Edge Pitch) on page 2-194</i>
Measurement parameter	Sets processing conditions for measurement and judgment conditions for measurement results. Measurement parameter can be changed as needed to address unstable measurement results. Specify the pitch and width for counting edges. The displayed items depend on whether your camera is a color or monochrome camera. Normally, the factory default value will be used. <i>2-13-4 Measurement Parameters (Edge Pitch) on page 2-195</i>
Output parameter	This item can be changed as necessary. Normally, the factory default value will be used. Use the output parameter to specify how to handle the coordinates. <i>2-13-5 Output Parameters (Edge Pitch) on page 2-197</i>

2-13-2 Region Setting (Edge Pitch)

This item is used to set up the measurement area.

Use a straight line, circumference, or arc to specify a measurement region for *Edge Pitch*.



Precautions for Correct Use

When setting up a measurement region, please include all the edges to be detected.

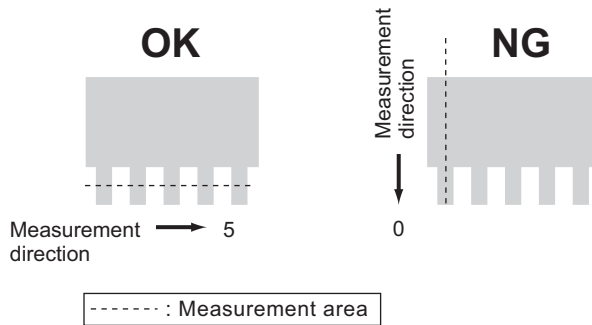

- 1 In the Item tab area, click **Region setting**.
- 2 Use the drawing tools to set the measurement region.
- 3 Click **OK** in the *Figure setting* area.
 - **OK**: Changes the settings and returns to the previous menu.
 - **Cancel**: Changes are discarded. Returns to the previous menu.
 - **Apply**: Updates the settings without leaving edit window.

2-13-3 Edge Color Specification - For Color Cameras Only (Edge Pitch)

Specify the target color to be counted.

- 1 In the Item tab area, click **Edge color**.
- 2 Specify the target color for the edges to be counted (used as the reference color for edge detecting).

Setting item	Setting value [Factory default]	Description
Image Display area	-	Specify a region on the image that includes the target color. The average color of the specified region is registered.
Color chart	-	Click the reference color on the color chart to specify it. The RGB values for the specified color are displayed at the bottom.
R, G, B	0 to 255 [255]	The color to be detected is set with the RGB values.
Difference R, G, B	0 to 127 [5]	This sets the allowable color difference for detecting the edge, using the specified color as the reference. The larger the difference values, the larger the color range that is used to detect the edge.

2-13-4 Measurement Parameters (Edge Pitch)

This item specifies the judgment condition for measurement results. Measurement parameter can be changed as needed to address unstable measurement results.

- 1 In the Item tab area, click **Measurement**.
The edge profile of the measurement region is displayed as a graph in the *Image Display* area.

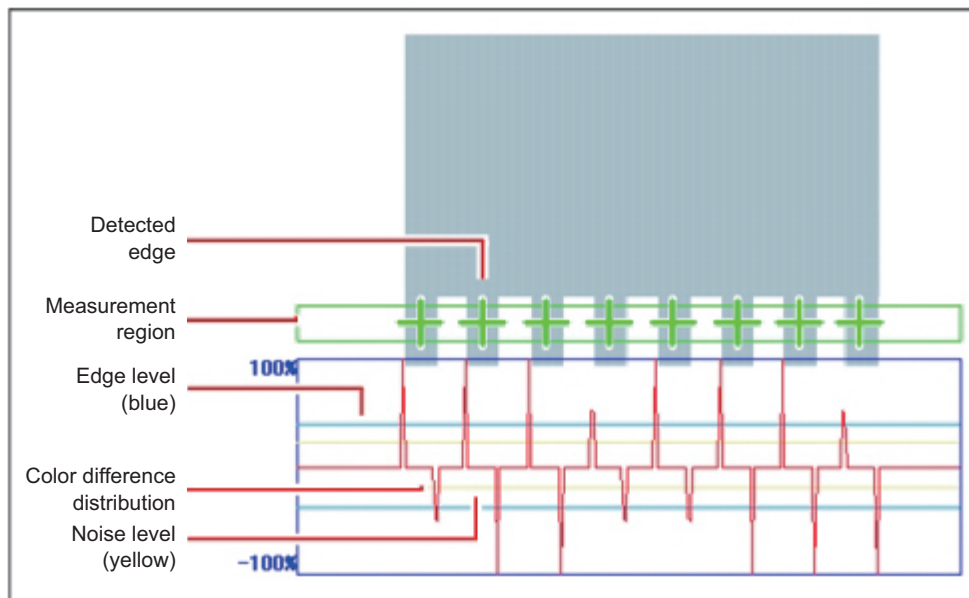

- 2 If necessary, specify a value for each item in the *Measurement condition* area.
 - For color cameras:

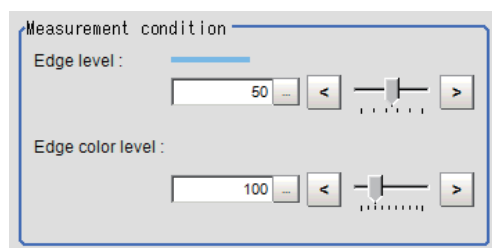

Setting item	Setting value [Factory default]	Description
Edge level	0 to 100 [50]	Specify a color changing level with which the edge is detected. When the measurement result is lower than the actual number of edges, specify a smaller value for the <i>edge level</i> . On the other hand, when the measurement result is higher than the actual number of edges, specify a larger value for the <i>edge level</i> . For details, refer to <i>Appendixes Measurement Mechanism Edge Detection Measurement</i> in the <i>Vision System FH/FHV Series User's Manual (Cat. No. Z365)</i> .
Edge color level	0 to 442 [100]	Set the emphasis level for the edge color specified with <i>Edge color</i> .

- For monochrome cameras:

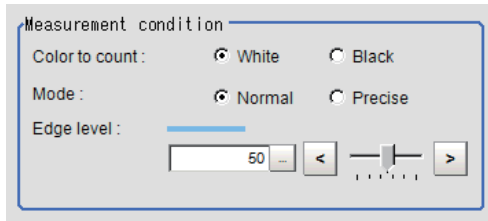

Precautions for Correct Use

Up to 1,000 edges can be measured, but only a maximum of 256 can be displayed on the screen.

Setting item	Setting value [Factory default]	Description
Color to count	<ul style="list-style-type: none"> • [White] • Black 	Select an edge color to be measured.
Mode	<ul style="list-style-type: none"> • [Normal] • Precise 	If the pin width or gap is less than 2 pixels, select precise.
Edge level	0 to 100 [50]	Specify the density change level to be detected as edges. When the measurement result is lower than the actual number of edges, specify a smaller value for the <i>edge level</i> . On the other hand, when the measurement result is higher than the actual number of edges, specify a larger value for the <i>edge level</i> . For details, refer to <i>Appendixes Measurement Mechanism Edge Detection Measurement</i> in the <i>Vision System FH/FHV Series User's Manual (Cat. No. Z365)</i> .

- 3** If necessary, set each item in the *Noise removal* area.

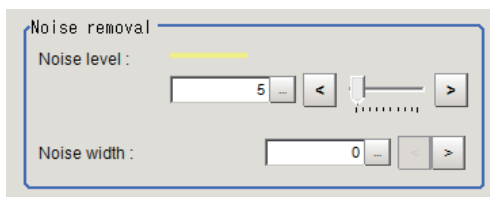

Setting item	Setting value [Factory default]	Description
Noise level	0 to 442 [5]	When edges are incorrectly detected due to noise, increase this value. For details, refer to <i>Appendixes Measurement Mechanism Edge Detection Measurement</i> in the <i>Vision System FH/FHV Series User's Manual (Cat. No. Z365)</i> .
Noise width	0 to 9,999 [0]	Set the width for judging noise. When detection is affected by noise, increase this value. For details, refer to <i>Appendixes Measurement Mechanism Edge Detection Measurement</i> in the <i>Vision System FH/FHV Series User's Manual (Cat. No. Z365)</i> .

- 4 When the setting has been changed, click **Measure** in the *Detail* area to verify whether measurements can be made correctly.

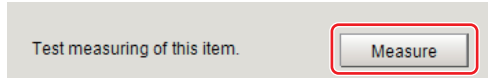

- 5 Set up the judgment condition.

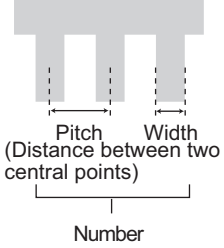
Setting item	Setting value	Description
Edges	0 to 999	Specify a range to be judged as OK. 
Pitch	0 to 99,999.9999	
Ave pitch	0 to 99,999.9999	
Width	0 to 99,999.9999	
Ave width	0 to 99,999.9999	

- 6 If a circumference with a width or an arc with a width is set for the region, set the profile display settings as required.

Setting item	Setting value [Factory default]	Description
Enlarged display	<ul style="list-style-type: none"> [Not Visible] Visible 	If you place a check here, the profile will be displayed for the length along the circumference of the circumference with a width or arc with a width. Use an enlarged display to check the details of the profile.

2-13-5 Output Parameters (Edge Pitch)

Specify how to treat the coordinates to be output to the external device as measurement results. This item can be changed if necessary. Normally, the factory default value will be used.



Precautions for Correct Use

After setting up the measurement parameters, changing the output parameters will cause measurement results to vary accordingly. If the output parameters have been changed, re-specify the measurement, too.

- 1 Click **Output parameter** in the Item tab area.
- 2 Specify each of the following items.

Setting item	Setting value [Factory default]	Description
Output coordinates	<ul style="list-style-type: none"> [After scroll] Before scroll 	As measurement results, select whether to output coordinate values to external devices before or after the position deflection correction is applied.

Setting item	Setting value [Factory default]	Description
Calibration	<ul style="list-style-type: none"> • ON • [OFF] 	Select whether to reflect the calibration in the values output to the external device as measurement results. <ul style="list-style-type: none"> • ON: Output the coordinates converted into actual dimensions. • OFF: Output the camera coordinate values.
Reflect to overall judgment	<ul style="list-style-type: none"> • [ON] • OFF 	Enables choosing whether or not the judgement results of this processing unit is reflected in the scene overall judgment.



Additional Information

For output coordinates and calibration, refer to *Appendixes Measurement Mechanism Handling Coordinates* in the *Vision System FH/FHV Series User's Manual (Cat. No. Z365)*.

2-13-6 Key Points for Test Measurement and Adjustment (Edge Pitch)

The following content is displayed in the *Detail result* area as text.

Displayed item	Description
Judge	Judgment results 0: No judgment (unmeasured) 1: Judgment result OK -1: Judgment result NG -10: Error (image format mismatch) -11: Error (unregistered model) -12: Error (insufficient memory) -20: Error (other errors)
No. of edges	No. of edges
Average pitch	Average edge pitch
Max. pitch	Edge maximum pitch
Min. pitch	Edge minimum pitch
Average edge width	The average value of all the edge width
Max. width	The maximum value of edge width
Min. width	The minimum value of edge width

The image specified in the Sub-image number in the image display setting is displayed in the *Image Display* area.

Sub-image number	Description of image to be displayed
0	Measurement image
1	Profile display

Key Points for Adjustment (Edge Pitch)

Adjust the setting parameters referring to the following points.

- When the measurement results are unstable

Parameter to be adjusted	Remedy
Edge color	If edges cannot be detected properly, specify a larger value for the color variance range.
Measurement parameter	If noise is detected as an edge, specify larger values for <i>Noise level</i> and <i>Noise width</i> .
Edge level	When the measurement result is lower than the actual number of edges, specify a smaller value for the <i>Edge level</i> . On the other hand, when the measurement result is higher than the actual number of edges, specify a larger value for the <i>Edge level</i> .

2-13-7 Measurement Results for Which Output Is Possible (Edge Pitch)

The following values can be output using processing items related to result output. It is also possible to reference measurement values from calculation expressions and other processing units.

Measurement items	Character string	Description
Judge	JG	Judgment results 0: No judgment (unmeasured) 1: Judgment result OK -1: Judgment result NG -10: Error (image format mismatch) -11: Error (unregistered model) -12: Error (insufficient memory) -20: Error (other errors)
No. of edges	N	No. of detected edges
Average pitch	P	Average pitch of detected edges
Max. pitch	PH	Maximum pitch of detected edges
Min. pitch	PL	Minimum pitch of detected edges
Average edge width	W	The average value of all the edge width
Max. width	WH	The maximum value of edge width
Min. width	WL	The minimum value of edge width

2-13-8 External Reference Tables (Edge Pitch)

No.	Data name	Data ident	Set/Get	Data range
0	Judge	judge	Get only	0: No judgment (unmeasured), 1: Judgment result OK, -1: Judgment result NG, -10: Error (image format mismatch), -11: Error (unregistered model), -12: Error (insufficient memory), -20: Error (other errors)
5	Number of Edge Pins	edgePitch	Get only	0 to 999
6	Average pitch	averagePitch	Get only	0 to 99,999.9999
7	Max. pitch	maxPitch	Get only	0 to 99,999.9999
8	Min. pitch	minPitch	Get only	0 to 99,999.9999

No.	Data name	Data ident	Set/Get	Data range
9	Average width	averageWidth	Get only	0 to 99,999.9999
10	Max. width	maxWidth	Get only	0 to 99,999.9999
11	Min. width	minWidth	Get only	0 to 99,999.9999
101	Output coordinates	outputCoordinate	Set/Get	0: After scroll, 1: Before scroll
102	Calibration	calibration	Set/Get	0: OFF, 1: ON
103	Reflect to overall judgement	overallJudge	Set/Get	0: ON, 1: OFF
120	Edge color R	colorR	Set/Get	0 to 255
121	Edge color G	colorG	Set/Get	0 to 255
122	Edge color B	colorB	Set/Get	0 to 255
123	Edge color difference R	colorDevR	Set/Get	0 to 127
124	Edge color difference G	colorDevG	Set/Get	0 to 127
125	Edge color difference B	colorDevB	Set/Get	0 to 127
127	Edge level	edgeLevel	Set/Get	0 to 100
128	Noise level	noiseLevel	Set/Get	Color camera: 0 to 442 Monochrome camera: 0 to 255
129	Noise width	noiseWidth	Set/Get	0 to 9,999
130	Upper limit of edge pitch	upperNumOfPitch	Set/Get	0 to 1,000
131	Lower limit of edge pitch	lowerNumOfPitch	Set/Get	0 to 1,000
132	Upper limit of average pitch	upperAveragePitch	Set/Get	0 to 99,999.9999
133	Lower limit of average pitch	lowerAveragePitch	Set/Get	0 to 99,999.9999
134	Upper limit of the pitch	upperPitch	Set/Get	0 to 99,999.9999
135	Lower limit of the pitch	lowerPitch	Set/Get	0 to 99,999.9999
136	Upper limit of average width	upperAverageWidth	Set/Get	0 to 99,999.9999
137	Lower limit of average width	lowerAverageWidth	Set/Get	0 to 99,999.9999
138	Upper limit of the width	upperWidth	Set/Get	0 to 99,999.9999
139	Lower limit of the width	lowerWidth	Set/Get	0 to 99,999.9999
140	Edge color level	colorLevel	Set/Get	0 to 442
141	Color to count	countColor	Set/Get	0: White, 1: Black
142	Mode	mode	Set/Get	0: Normal, 1: Precise
6,002	Format	cameraColor	Set/Get	1: Monochrome camera 2: Color camera
90,000	figure0 Count	figArea0_count	Set/Get	0 to 1
90,001	figure0 Type	figArea0_fig0_type	Set/Get	4: Wide line, 64: Circumference, 256: Wide arc

No.	Data name	Data ident	Set/Get	Data range
90,002	figure0 mode	figArea0_fig0_mode	Set/Get	0: OR
90,009	figure0 Wide line Start point X	figAr- ea0_fig0_lineW_X0	Set/Get	-99,999 to 99,999
90,010	figure0 Wide line Start point Y	figAr- ea0_fig0_lineW_Y0	Set/Get	-99,999 to 99,999
90,011	figure0 Wide line End point X	figAr- ea0_fig0_lineW_X1	Set/Get	-99,999 to 99,999
90,012	figure0 Wide line End point Y	figAr- ea0_fig0_lineW_Y1	Set/Get	-99,999 to 99,999
90,013	figure0 Wide line Width	figAr- ea0_fig0_lineW_W	Set/Get	0 to 99,999
90,025	figure0 Circumfer- ence Center Position X	figArea0_fig0_cir- cleW_X	Set/Get	-99,999 to 99,999
90,026	figure0 Circumfer- ence Center Position Y	figArea0_fig0_cir- cleW_Y	Set/Get	-99,999 to 99,999
90,027	figure0 Circumfer- ence Radius	figArea0_fig0_cir- cleW_R	Set/Get	0 to 99,999
90,028	figure0 Circumfer- ence Width	figArea0_fig0_cir- cleW_W	Set/Get	0 to 99,999
90,034	figure0 Wide arc Center Position X	figAr- ea0_fig0_arcW_X	Set/Get	-99,999 to 99,999
90,035	figure0 Wide arc Center Position Y	figAr- ea0_fig0_arcW_Y	Set/Get	-99,999 to 99,999
90,036	figure0 Wide arc Ra- dius	figAr- ea0_fig0_arcW_R	Set/Get	0 to 99,999
90,037	figure0 Wide arc Start angle	figAr- ea0_fig0_arcW_SA	Set/Get	-180 to 180
90,038	figure0 Wide arc End angle	figAr- ea0_fig0_arcW_EA	Set/Get	-180 to 180
90,039	figure0 Wide arc Width	figAr- ea0_fig0_arcW_W	Set/Get	0 to 99,999
90,099	figure0 Update	figArea0_update	Set only	1: Update

2-14 Scan Edge Position

This processing item detects the position of the measurement object by using the change in color within the measurement region. By dividing the measurement region, the following effects can be expected compared to ordinary edge position measurement.

- Detailed information, such as the closest point or furthest point from the measurement start point, can be calculated.
- The inclination or degree of unevenness of the measured object can be calculated.

Used in the Following Case

When calculating multiple edge positions of the measurement object from statistical data:

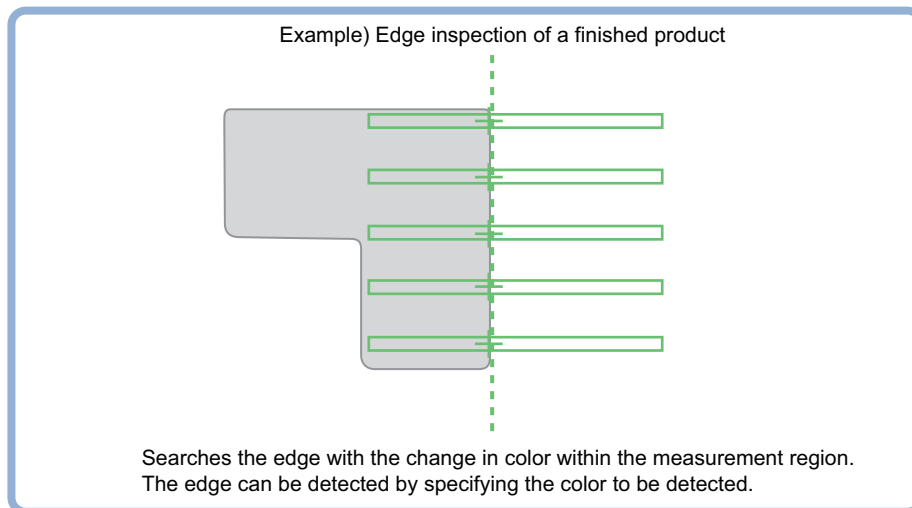

Precautions for Correct Use

Processing is different for color images and monochrome images. When the camera type used in the previous setup was changed to color or monochrome type, perform the settings again.



Additional Information

Edge processing basic concepts:

For details, refer to *Appendixes Measurement Mechanism Edge Detection Measurement* in the *Vision System FH/FHV Series User's Manual (Cat. No. Z365)*.

2-14-1 Settings Flow (Scan Edge Position)

To set Scan Edge Position, follow the steps below.

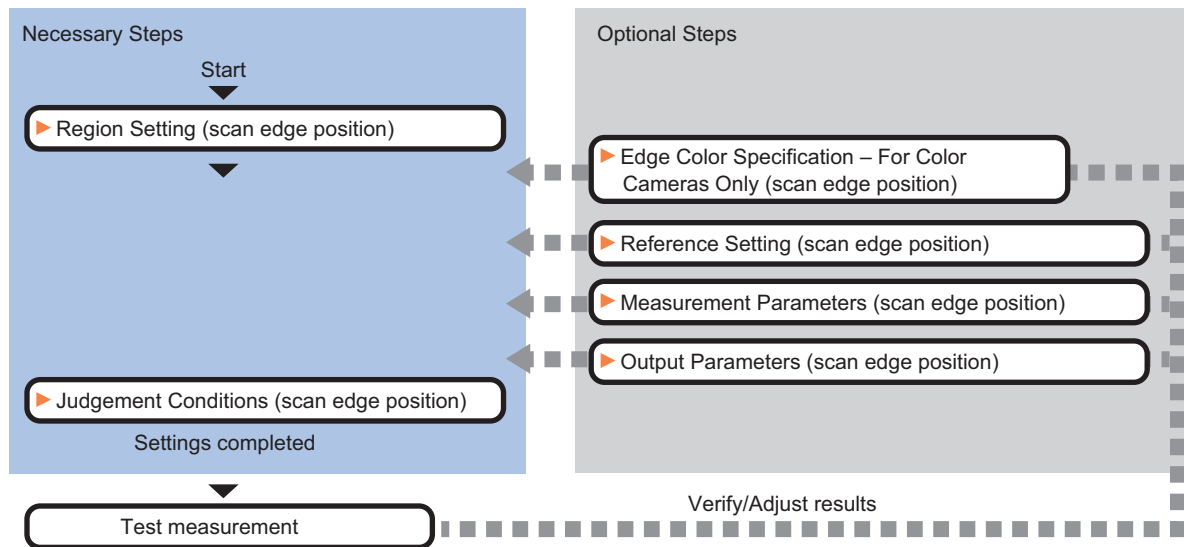

Item List for Scan Edge Position

Item	Description
Region setting	Sets the measurement area. <i>2-14-2 Region Setting (Scan Edge Position) on page 2-204</i>
Edge color (for color cameras only)	This item selects the color of the edges to be detected. If the target color changes, this setting is not necessary. If the color is not specified, positions in the measurement region where the color changes drastically are detected as an edge. <i>2-14-3 Edge Color Specification - For Color Cameras Only (Scan Edge Position) on page 2-205</i>
Ref. setting	This item can be changed as necessary. Specify the reference position within the camera's field of view. <i>2-14-4 Reference Setting (Scan Edge Position) on page 2-206</i>
Measurement parameter	Measurement parameter can be changed as needed to address unstable measurement results. The displayed items depend on whether your camera is a color or monochrome camera. Normally, the factory default value will be used. <i>2-14-5 Measurement Parameters (Scan Edge Position) on page 2-208</i>
Judgment condition	Sets processing conditions for measurement and judgment conditions for measurement results. <i>2-14-6 Judgment Conditions (Scan Edge Position) on page 2-212</i>
Output parameter	This item can be changed as necessary. Normally, the factory default value will be used. Use the output parameter to specify how to handle the coordinates. <i>2-14-7 Output Parameters (Scan Edge Position) on page 2-213</i>

2-14-2 Region Setting (Scan Edge Position)

This item is used to set up the measurement area.

Specify the measurement region for *Scan Edge Position* by using wide straight lines.

- 1 In the Item tab area, click **Region setting**.
- 2 Use the Drawing tools to specify the measurement region.
To align with the measurement area and change the number of measurement points, uncheck this.
If the width of the measurement region is changed with the checkbox unchecked, the number of measurement points in Scan-sub-region is changed to minimize the amount of change of the scanned region interval.

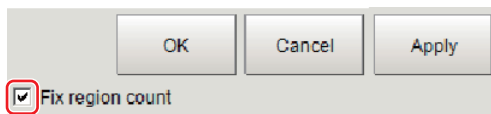

- 3 Click **OK** in the *Figure setting* area.
 - **OK**: Changes the settings and returns to the previous menu.
 - **Cancel**: Changes are discarded. Returns to the previous menu.
 - **Apply**: Updates the settings without leaving edit window.
- 4 Set the measurement point and the filter size for the region.

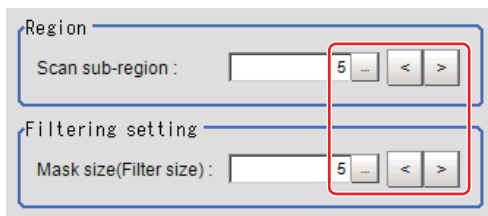

Setting item	Setting value [Factory default]	Description
Scan sub-region	1 to 4,000 [5]	Set the measurement point for the region.
Mask size	0 to 200 [5]	Set the filter size when smoothing the measurement point vicinity. When 5 is set, smoothing is processed for a total of 11 points: the measurement point and the 5 pixels before and after it.

- 5 The region is divided equally.

Division of Scan Area

The scan region, when the number of measurement points is 1

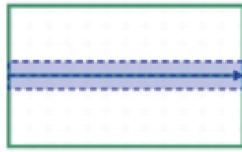

The scan region, when the number of measurement points is 2

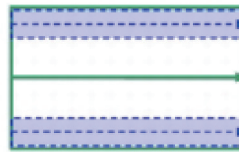

The scan region, when the number of measurement points is 3

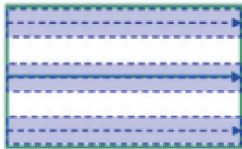

The scan region, when the number of measurement points is 4

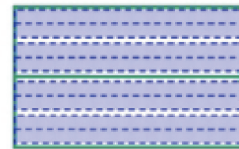

- 6** Perform the display setting if required.
Placing a check at *Filtered image* makes it easier to change the filtering setting.

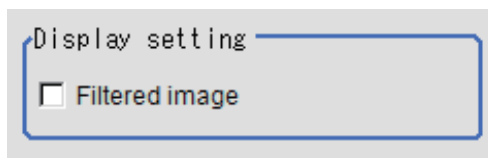

Setting item	Setting value [Factory default]	Description
Filtered image	<ul style="list-style-type: none"> • Checked • [Unchecked] 	If checked, the filtered image of the ranges set with the <i>Scan sub-region</i> and <i>Mask size</i> after smoothing is displayed.



Additional Information

You can specify enable/disable for each edge measurement number. Clicking edge measurement points displays the following screen.

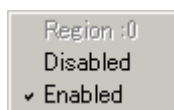

2-14-3 Edge Color Specification - For Color Cameras Only (Scan Edge Position)

This item selects the color of the edges to be detected.

If the target color changes, this setting is not necessary. If the color is not specified, positions in the measurement region where the color changes drastically are detected as an edge.

- 1** In the Item tab area, click **Edge color**.
- 2** Place a check at *Edge color specification* in the *Color setting* area.

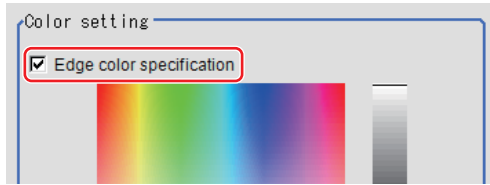

3 Select the color to detect as edges.

Setting item	Setting value [Factory default]	Description
Image Display area	-	Specify a region on the image that includes the target color. The average color of the specified region is registered.
Color chart	-	Click the reference color on the color chart to specify it. The RGB values for the specified color are displayed at the bottom.
R, G, B	0 to 255 [255]	The color to be detected is set with the RGB values.
Difference R, G, B	0 to 127 [5]	This sets the allowable color difference for detecting the edge, using the specified color as the reference. The larger the difference values, the larger the color range that is used to detect the edge.
Detection mode	<ul style="list-style-type: none"> [Color IN] Color OUT 	<ul style="list-style-type: none"> Color IN: The position where a color other than the specified color changes to the specified color is detected as the edge. Color OUT: The position where the specified color changes to a color other than the specified color is detected as the edge. <div style="display: flex; justify-content: space-around; align-items: flex-start;"> <div style="text-align: center;"> <p>For "Color IN" edge measurement mode</p> </div> <div style="text-align: center;"> <p>For "Color OUT" edge measurement mode</p> </div> </div> <div style="display: flex; justify-content: space-around; align-items: flex-start; margin-top: 20px;"> <div style="text-align: center;"> <p>For "Color IN" edge measurement mode</p> </div> <div style="text-align: center;"> <p>For "Color OUT" edge measurement mode</p> </div> </div>

2-14-4 Reference Setting (Scan Edge Position)

When the model is set, this position is automatically set at the same time as the reference position. This item can be set to change the reference position to any desired position. This is handy for measuring the position deviation from a certain position. A reference position can be set either directly or by referencing a unit.

Specifying directly

Click a position on the image you want to use as a reference position, or input coordinate data for that point.

- 1 In the Item tab area, click **Ref. setting**.
In the *Display* area, the current reference position will be displayed as the crosshair cursor.

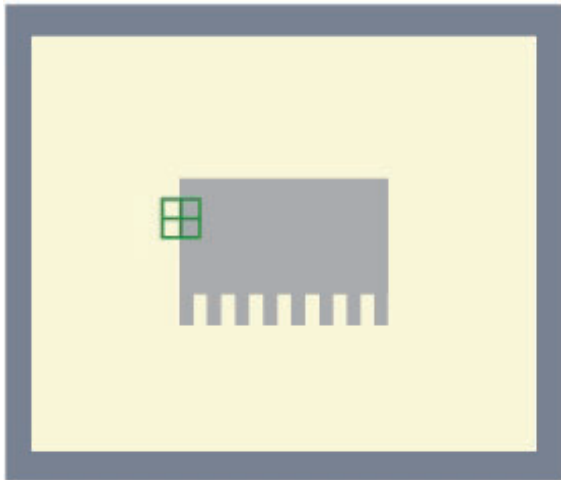

- 2 In the *Method* area, select *Numerical*.

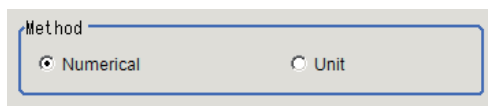

- 3 Click the position to be set as the reference.



Additional Information

Displaying the image enlarged makes this clicking easier.

For details, refer to *Appendixes Basic Knowledge about Operations Using the Zoom Function in the Vision System FH/FHV Series User's Manual (Cat. No. Z365)*.

- 4 Make fine adjustments using numeric value inputs or the arrow buttons as required.

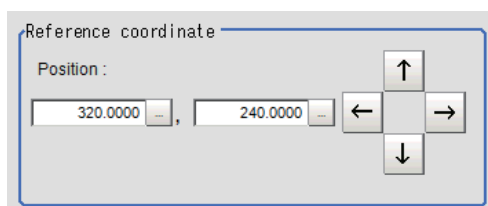

- 5 To remeasure on the displayed image and set the reference, click the **Measure ref.** button.
- 6 To use data before position compensation for the reference setting coordinates, place a check at *Use point coordinate before scroll*.

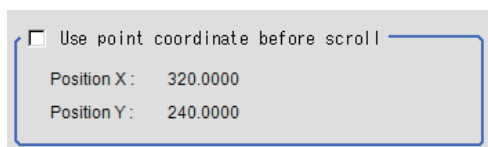

Referencing a Unit

Set a reference by referencing a detection point unit with registered X coordinate, Y coordinate and angle data.

- 1 In the Item tab area, click **Ref. setting**.
In the *Display* area, the current reference position will be displayed as the crosshair cursor.
- 2 In the *Method* area, select *Unit*.



- 3 In the *Unit* area, select a detection point unit in the scene.

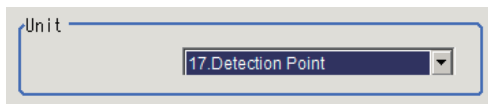

Performing the next measurement will display the reference.

2-14-5 Measurement Parameters (Scan Edge Position)

Measurement parameters can be changed as needed to address unstable measurement results. Normally, the factory default value will be used.

After changing a setting, check whether measurement can be done properly by performing an actual measurement.

- 1 In the Item tab area, click **Measurement**.
The edge profile of the measurement region is displayed as a graph in the *Image Display* area.

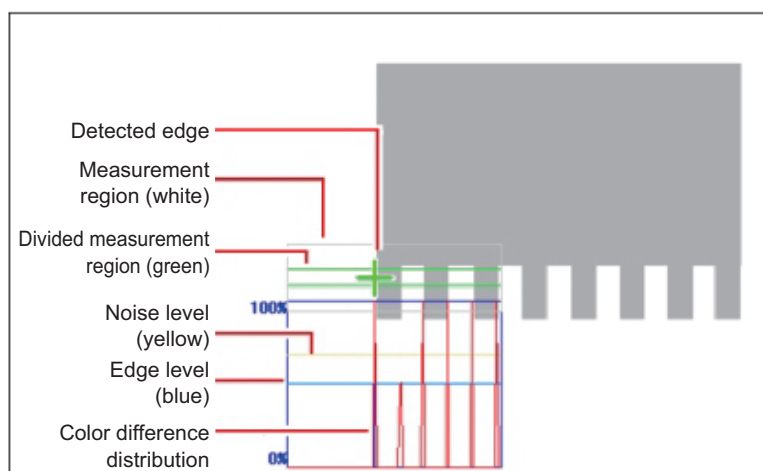

- 2 Set the value of each item in the *Display position* area.

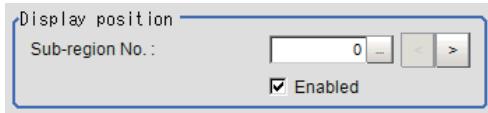

Setting item	Setting value [Factory default]	Description
Sub-region No.	0 to 3,999 [0]	Specify the <i>Sub-region No.</i> for which the edge profile is displayed.
Enabled	<ul style="list-style-type: none"> [Checked] Unchecked 	Specify enable/disable for the displayed <i>Sub-region No.</i> . When disabled (unchecked) is specified, that <i>Sub-region No.</i> is not measured.

3 If necessary, specify a value for each item in the *Measurement condition* area.

- For color cameras:

Edge Color Not Specified

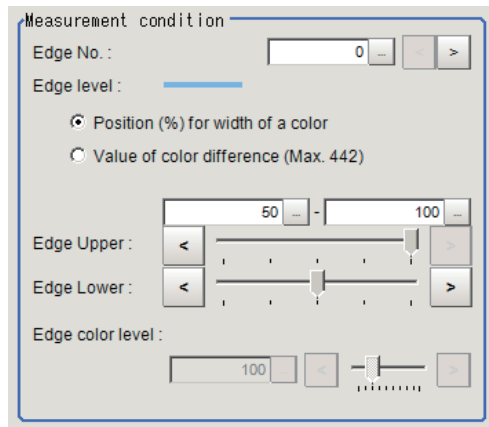

Edge Color Specified

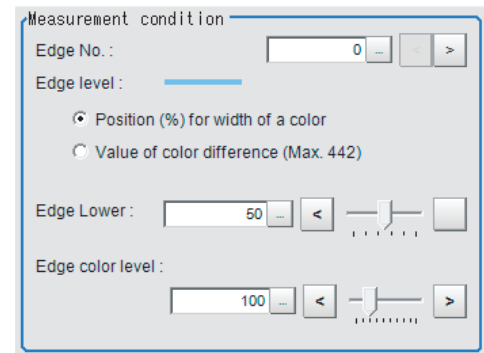

Setting item	Setting value [Factory default]	Description
Edge No.	0 to 99 [0]	Specify the edge number used to extract edges. <i>Edge numbers</i> are assigned to detected edges starting from 0 and going on in the direction from the start point (the arrow point) to the end point (the direction of arrow) in the selected area.
Edge Upper (only when edge color is not specified) Edge Lower	<ul style="list-style-type: none"> Position (%) for width of a color 0 to 100 [50] to [100] Value of color 0 to 442 [20] to [442] 	Set a range of a color difference level with which the edge is detected. For details, refer to <i>Appendixes Measurement Mechanism Edge Detection Measurement</i> in the <i>Vision System FH/FHV Series User's Manual (Cat. No. Z365)</i> .
Edge color level	0 to 442 [100]	This emphasis level can be specified only if the edge color to detect is specified.

- For monochrome cameras:

When the *Measurement type* is *Projection*:

When the *Measurement type* is *Derivation*:

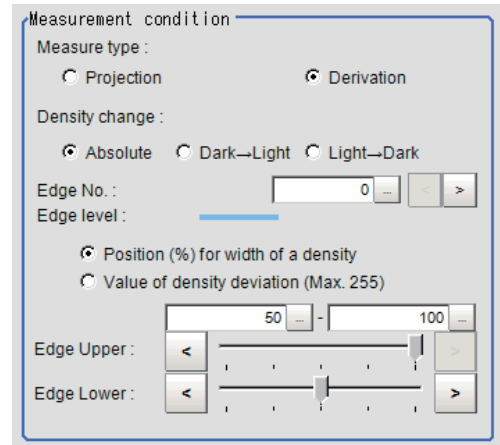
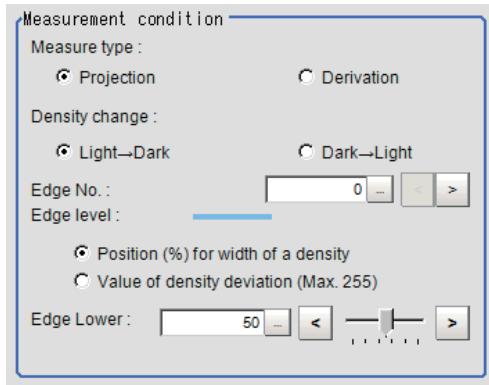

Setting item	Setting value [Factory default]	Description
Measure type	<ul style="list-style-type: none"> [Projection] Derivation 	<p>As the <i>Measurement type</i>, specify either <i>Projection</i> or <i>Derivation</i>.</p> <p>For details, refer to <i>Appendixes Measurement Mechanism Edge Detection Measurement</i> in the <i>Vision System FH/FHV Series User's Manual (Cat. No. Z365)</i>.</p>
Density change	<ul style="list-style-type: none"> Absolute (only when the <i>Measure type</i> is <i>Derivation</i>) [Dark → Light] Light → Dark 	Select whether a black-to-white change or a white-to-black change should be recognized as a density change in the specified region.
Edge No.	0 to 99 [0]	Specify the edge number used to extract edges. <i>Edge numbers</i> are assigned to detected edges starting from 0 and going on in the direction from the start point (the arrow point) to the end point (the direction of arrow) in the selected area.
Edge Upper Edge Lower	<ul style="list-style-type: none"> Position (%) for width of a density 0 to 100 [50] to [100] Value of density 0 to 255 [20] to [255] 	<p>Select the density change level to be detected as edges. The upper limit of edges can be set only when the <i>Measure type</i> is <i>Derivation</i>.</p> <p>For details, refer to <i>Appendixes Measurement Mechanism Edge Detection Measurement</i> in the <i>Vision System FH/FHV Series User's Manual (Cat. No. Z365)</i>.</p>

4 If necessary, set each item in the *Noise removal* area.

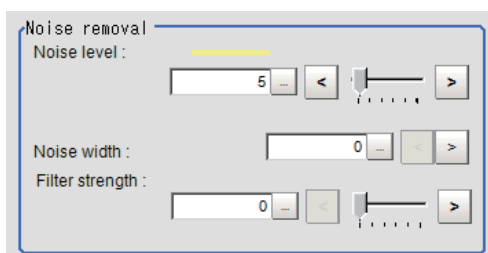

Setting item	Setting value [Factory default]	Description
Noise level	<ul style="list-style-type: none"> For color cameras: 0 to 442 [5] For mono-chrome cameras: 0 to 255 [5] 	When edges are incorrectly detected due to noise, increase this value. For details, refer to <i>Appendixes Measurement Mechanism Edge Detection Measurement</i> in the <i>Vision System FH/FHV Series User's Manual (Cat. No. Z365)</i> .
Noise width	0 to 9,999 [0]	Set the width for judging noise. When detection is affected by noise, increase this value. For details, refer to <i>Appendixes Measurement Mechanism Edge Detection Measurement</i> in the <i>Vision System FH/FHV Series User's Manual (Cat. No. Z365)</i> .
Filter strength	0 to 100 [0]	If a valley appears in the histogram around the edge threshold value due to noises, smoothen the edge profile using a filter to prevent wrong error detection from being detected. Strengthening the filter smoothen the edge profile further.

5 In the Sub-region detail area, set enable or disable measurement as required.

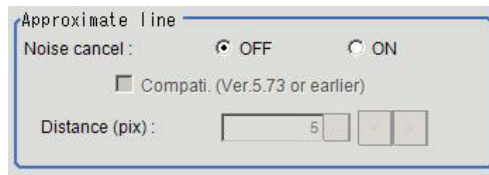

Setting item	Setting value [Factory default]	Description
Noise cancel	<ul style="list-style-type: none"> ON [OFF] 	When placing a check at <i>ON</i> , an approximate line is calculated by excluding the points with large deviation among the measured points.
Rate	0 to 100 [50]	Set the ratio of measurement points used for approximate straight line calculation to all measurement points. When there is considerable noise, reducing this value enables calculation of an approximate straight line with many of the noise points removed. When there is little noise, increasing this value enables calculation of a high-accuracy straight line using many measurement points. *1
Distance (pix)	0 to 10,000 [5]	Sets the degree of "Noise cancel" with a distance to the approximate line. *2
Compati. (Ver.5.73 or earlier)	<ul style="list-style-type: none"> Checked [Unchecked] 	Sets the compatible mode for "Noise cancel". Check this when scene data before Ver.5.73 was loaded.

*1. When *Noise cancel* is *ON* and *Compati. (Ver.5.73 or earlier)* is checked, this is displayed.

*2. When *Noise cancel* is *ON* and *Compati. (Ver.5.73 or earlier)* is unchecked, this is displayed.



Precautions for Correct Use

When using the compatibility mode (Ver. 5.73 or earlier) to calculate an approximate line, be sure to control the number of edge measurement points no more than 100.

2-14-6 Judgment Conditions (Scan Edge Position)

Specify the range to be judged as OK.

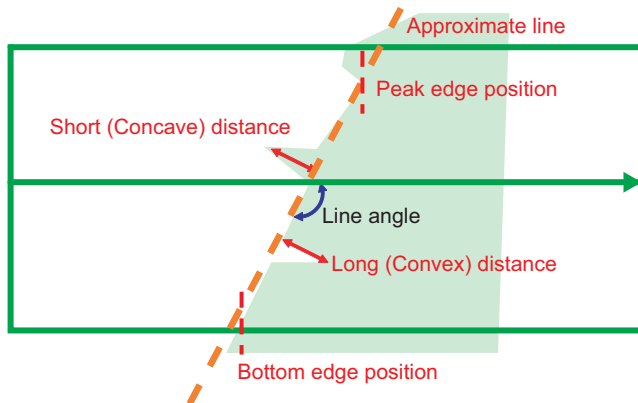

- 1 In the Item Tab area, click **Judgement**.
- 2 Set up the judgment condition.

Setting item	Setting value	Description
Peak edge position X	-99,999.9999 to 99,999.9999	Specify the X-axis upper and lower limits of the peak edge position X judged to be OK.
Peak edge position Y	-99,999.9999 to 99,999.9999	Specify the Y-axis upper and lower limits of the peak edge position Y judged to be OK.
Bottom edge position X	-99,999.9999 to 99,999.9999	Specify the X-axis upper and lower limits of the bottom edge position X judged to be OK.
Bottom edge position Y	-99,999.9999 to 99,999.9999	Specify the Y-axis upper and lower limits of the bottom edge position Y judged to be OK.
Edge position X Ave.	-99,999.9999 to 99,999.9999	Specify the X-axis upper and lower limits of the average edge position judged to be OK.
Edge position Y Ave.	-99,999.9999 to 99,999.9999	Specify the Y-axis upper and lower limits of the average edge position judged to be OK.
Long distance Max.	0 to 99,999.9999	Specify the upper and lower limits of the long distance maximum judged to be OK.
Long distance Min.	0 to 99,999.9999	Specify the upper and lower limits of the long distance minimum judged to be OK.
Short distance Max.	0 to 99,999.9999	Specify the upper and lower limits of the short distance maximum judged to be OK.
Short distance Min.	0 to 99,999.9999	Specify the upper and lower limits of the short distance minimum judged to be OK.
Deviation	0 to 99,999.9999	Specify the upper and lower limits of the deviation judged to be OK.
Line angle	-180 to 180	Specify the upper and lower limits of the line angle judged to be OK.

Setting item	Setting value	Description
Lost point count	0 to 4,000	Specify the upper and lower limits of the lost point count judged to be OK.



Additional Information

Judgement condition of the straight line's inclination

To set $90 \pm 10^\circ$ (80 to 90° , -80 to -90°) range as OK, set the judgement condition to 80 to 100° . The range of straight line's inclination is -89.999 to 90° . Internally, the angle X of -90 to 0° is the same value as $X + 180^\circ$, the angle X of 90 to 180° is the same value as $X - 180^\circ$.

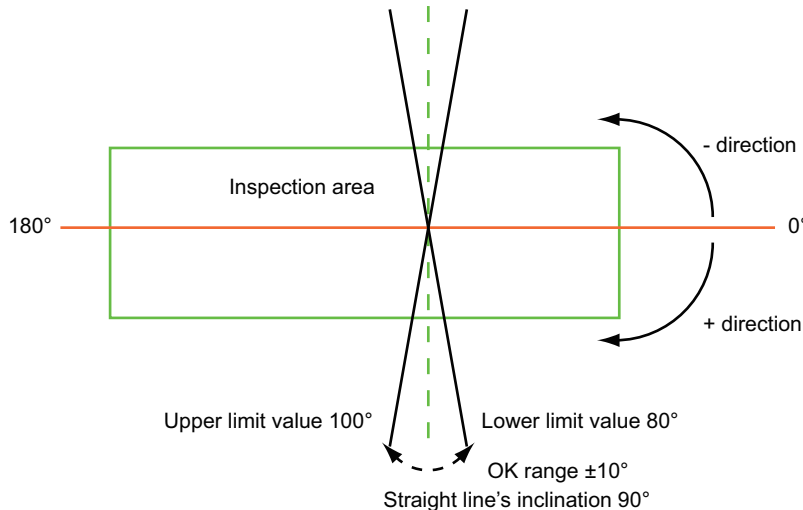

2-14-7 Output Parameters (Scan Edge Position)

Specify how to treat the coordinates to be output to the external device as measurement results. This item can be changed if necessary. Normally, the factory default value will be used.



Precautions for Correct Use

After setting up the measurement parameters, changing the output parameters will cause measurement results to vary accordingly. If the output parameters have been changed, re-specify the measurement, too.

- 1 Click **Output parameter** in the Item tab area.
- 2 Specify each of the following items.

Setting item	Setting value [Factory default]	Description
Output coordinates	<ul style="list-style-type: none"> • [After scroll] • Before scroll 	As measurement results, select whether to output coordinate values to external devices before or after the position deflection correction is applied.
Calibration	<ul style="list-style-type: none"> • ON • [OFF] 	Select whether to reflect the calibration in the values output to the external device as measurement results. <ul style="list-style-type: none"> • ON: Output the coordinates converted into actual dimensions. • OFF: Output the camera coordinate values.

Setting item	Setting value [Factory default]	Description
Reflect to overall judgment	<ul style="list-style-type: none"> • [ON] • OFF 	Enables choosing whether or not the judgement results of this processing unit is reflected in the scene overall judgment.



Additional Information

For output coordinates and calibration, refer to *Appendixes Measurement Mechanism Handling Coordinates* in the *Vision System FH/FHV Series User's Manual (Cat. No. Z365)*.

2-14-8 Key Points for Test Measurement and Adjustment (Scan Edge Position)

In addition to the camera input image, the measured region, a graphic display of the measured results, and the edge position (the crosshair cursor) are also displayed as results in the Image Display area.

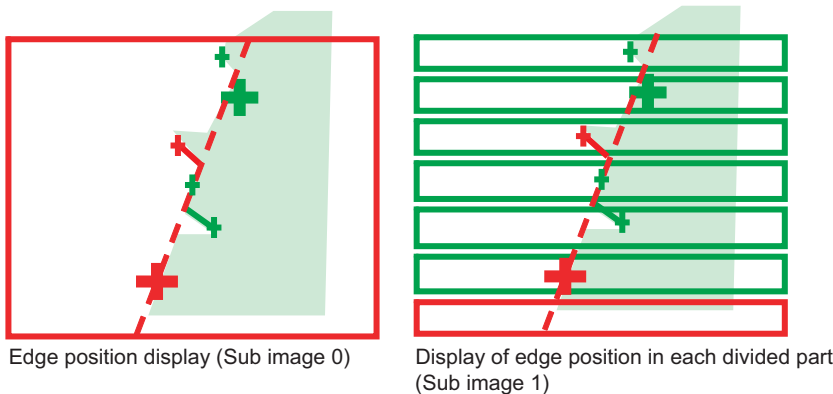

The following content is displayed in the *Detail result* area as text.

Displayed item	Description
Judge	Judgment results 0: No judgment (unmeasured) 1: Judgment result OK -1: Judgment result NG -10: Error (image format mismatch) -11: Error (unregistered model) -12: Error (insufficient memory) -20: Error (other errors)
Peak edge position X	X coordinate of the edge that is the furthest from the start point of the measurement region
Peak edge position Y	Y coordinate of the edge that is the furthest from the start point of the measurement region
Bottom edge position X	X coordinate of the edge that is the closest to the start point of the measurement region
Bottom edge position Y	Y coordinate of the edge that is the closest to the start point of the measurement region
Edge position X Ave.	The average of X coordinates of all the edges
Edge position Y Ave.	The average of Y coordinates of all the edges
Long distance Max.	The maximum distance between the approximate line and edge position (plus direction)
Short distance Max.	The minimum distance between the approximate line and the edge position (minus direction)

Displayed item	Description
Deviation	Deviations in concavity and convexity (Value of the standard deviation for the distance of each edge point from the linear regression)
Line angle	The straight line's inclination against the measurement region
No. of lost points	No. of regions for which the detection of edges has failed

The image specified in the Sub-image number in the image display setting is displayed in the *Image Display* area.

Sub-image number	Description of image to be displayed
0	Measurement image
1	Scan region

Key Points for Adjustment (Scan Edge Position)

Adjust the setting parameters referring to the following points.

● When the measurement results are unstable

Parameter to be adjusted	Remedy
Measurement parameter	When the color of the edges to be detected is decided, specify the color with <i>Edge color</i> . If results are not stable even with the color specified, specify a larger value for the color variance range. If noise is detected as an edge, specify larger values for <i>Noise level</i> and <i>Noise width</i> .

2-14-9 Measurement Results for Which Output Is Possible (Scan Edge Position)

The following values can be output using processing items related to result output. It is also possible to reference measurement values from calculation expressions and other processing units.

Measurement items	Character string	Description
Judge	JG	Judgment results 0: No judgment (unmeasured) 1: Judgment result OK -1: Judgment result NG -10: Error (image format mismatch) -11: Error (unregistered model) -12: Error (insufficient memory) -20: Error (other errors)
Peak edge position X	PEAKX	X coordinate of the edge that is the furthest from the start point of the measurement region
Peak edge position Y	PEAKY	Y coordinate of the edge that is the furthest from the start point of the measurement region
Bottom edge position X	BOTTOMX	X coordinate of the edge that is the closest to the start point of the measurement region
Bottom edge position Y	BOTTOMY	Y coordinate of the edge that is the closest to the start point of the measurement region
Edge position X Ave.	X	The average of X coordinates of all the edges

Measurement items	Character string	Description
Edge position Y Ave.	Y	The average of Y coordinates of all the edges
Ref. position X	SX	X coordinate of the reference coordinates
Ref. position Y	SY	Y coordinate of the reference coordinates
Long distance Max.	PMAXD	The maximum distance between the approximate line and edge position (plus direction)
Long distance Min.	PMIND	The minimum distance between the approximate line and the edge position (plus direction)
Short distance Max.	BMAXD	The maximum distance between the approximate line and the edge position (minus direction)
Short distance Min.	BMIND	The minimum distance between the approximate line and the edge position (minus direction)
Deviation	DEV	Deviations in concavity and convexity (Value of the standard deviation for the distance of each edge point from the linear regression)
Line angle	TH	The straight line's inclination against the measurement region
No. of lost points	LOST	No. of regions for which the detection of edges has failed
Line Param. A	A	A in the expression for the approximate line $AX + BY + C = 0$
Line Param. B	B	B in the expression for the approximate line $AX + BY + C = 0$
Line Param. C	C	C in the expression for the approximate line $AX + BY + C = 0$

2-14-10 External Reference Tables (Scan Edge Position)

No.	Data name	Data ident	Set/Get	Data range
0	Judge	judge	Get only	0: No judgment (unmeasured), 1: Judgment result OK, -1: Judgment result NG, -10: Error (image format mismatch), -11: Error (unregistered model), -12: Error (insufficient memory), -20: Error (other errors)
1	Peak edge position X	peakEdgePosX	Get only	-99,999.9999 to 99,999.9999
2	Peak edge position Y	peakEdgePosY	Get only	-99,999.9999 to 99,999.9999
3	Bottom edge position X	bottomEdgePosX	Get only	-99,999.9999 to 99,999.9999
4	Bottom edge position Y	bottomEdgePosY	Get only	-99,999.9999 to 99,999.9999
5	Edge position X Ave.	aveEdgePosX	Get only	-99,999.9999 to 99,999.9999
6	Edge position Y Ave.	aveEdgePosY	Get only	-99,999.9999 to 99,999.9999
7	Long distance Max.	maxPeakDist	Get only	-1 to 99,999.9999
8	Long distance Min.	minPeakDist	Get only	-1 to 99,999.9999
9	Short distance Max.	maxBottomDist	Get only	-1 to 99,999.9999
10	Short distance Min.	minBottomDist	Get only	-1 to 99,999.9999
11	Deviation	deviation	Get only	-1 to 99,999.9999

No.	Data name	Data ident	Set/Get	Data range
12	Angle	lineAngle	Get only	-180 to 180
13	Lost point	lostPoint	Get only	0 to 4,000
14	Linear coefficient A	coefficientA	Get only	-99,999.9999 to 99,999.9999
15	Linear coefficient B	coefficientB	Get only	-99,999.9999 to 99,999.9999
16	Linear coefficient C	coefficientC	Get only	-99,999.9999 to 99,999.9999
17	Reference X	referenceX	Get only	0 to 99,999.9999
18	Reference Y	referenceY	Get only	0 to 99,999.9999
101	Output coordinates	outputCoordinate	Set/Get	0: After scroll, 1: Before scroll
102	Calibration	calibration	Set/Get	0: OFF, 1: ON
103	Reflect to overall judgement	overallJudge	Set/Get	0: ON, 1: OFF
120	Edge color specification	colorSpecification	Set/Get	0: OFF, 1: ON
121	Edge color R	colorR	Set/Get	0 to 255
122	Edge color G	colorG	Set/Get	0 to 255
123	Edge color B	colorB	Set/Get	0 to 255
124	Difference R	colorDevR	Set/Get	0 to 127
125	Difference G	colorDevG	Set/Get	0 to 127
126	Difference B	colorDevB	Set/Get	0 to 127
127	Detection mode	detectionMode	Set/Get	0: Color IN, 1: Color OUT
129	Reference X	referencePosX	Set/Get	0 to 99,999.9999
130	Reference Y	referencePosY	Set/Get	0 to 99,999.9999
131	Edge No.	edgeNo	Set/Get	0 to 99
132	Edge level Lower limit	edgeLevel	Set/Get	0 to 100
133	Noise level	noiseLevel	Set/Get	Color camera: 0 to 442 Monochrome camera: 0 to 255
134	Noise width	noiseWidth	Set/Get	0 to 9,999
135	Edge color level	colorLevel	Set/Get	0 to 442
136	Upper limit of the peak edge position X	upperPeakX	Set/Get	-99,999.9999 to 99,999.9999
137	Lower limit of the peak edge position X	lowerPeakX	Set/Get	-99,999.9999 to 99,999.9999
138	Upper limit of the peak edge position Y	upperPeakY	Set/Get	-99,999.9999 to 99,999.9999
139	Lower limit of the peak edge position Y	lowerPeakY	Set/Get	-99,999.9999 to 99,999.9999
140	Upper limit of the bottom edge position X	upperBottomX	Set/Get	-99,999.9999 to 99,999.9999
141	Lower limit of the bottom edge position X	lowerBottomX	Set/Get	-99,999.9999 to 99,999.9999
142	Upper limit of the bottom edge position Y	upperBottomY	Set/Get	-99,999.9999 to 99,999.9999

No.	Data name	Data ident	Set/Get	Data range
143	Lower limit of the bottom edge position Y	lowerBottomY	Set/Get	-99,999.9999 to 99,999.9999
144	Upper limit of the edge position X Ave.	upperAveEdgePosX	Set/Get	-99,999.9999 to 99,999.9999
145	Lower limit of the edge position X Ave.	lowerAveEdgePosX	Set/Get	-99,999.9999 to 99,999.9999
146	Upper limit of the edge position Y Ave.	upperAveEdgePosY	Set/Get	-99,999.9999 to 99,999.9999
147	Lower limit of the edge position Y Ave.	lowerAveEdgePosY	Set/Get	-99,999.9999 to 99,999.9999
148	Upper limit of the long distance Max.	upperMaxPeakDist	Set/Get	0 to 99,999.9999
149	Lower limit of the long distance Max.	lowerMaxPeakDist	Set/Get	0 to 99,999.9999
150	Upper limit of the short distance Max.	upperMaxBottomDist	Set/Get	0 to 99,999.9999
151	Lower limit of the short distance Max.	lowerMaxBottomDist	Set/Get	0 to 99,999.9999
152	Upper limit of the deviation	upperDeviation	Set/Get	0 to 99,999.9999
153	Lower limit of the deviation	lowerDeviation	Set/Get	0 to 99,999.9999
154	Upper limit of the angle	upperAngle	Set/Get	-180 to 180
155	Lower limit of the angle	lowerAngle	Set/Get	-180 to 180
156	Upper limit of the lost point	upperLostPoint	Set/Get	0 to 4,000
157	Lower limit of the lost point	lowerLostPoint	Set/Get	0 to 4,000
158	Monochrome edge detection mode	monoDetectMode	Set/Get	0: Light → Dark, 1: Dark → Light
159	Edge level Lower limit absolute value	edgeLevelAbs	Set/Get	Color camera: 0 to 442 Monochrome camera: 0 to 255
160	Edge level specification method	edgeLevelKind	Set/Get	0: %, 1: Absolute value
162	Scan sub-region	scanLines	Set/Get	1 to 4,000
163	Mask size(Filter size)	scanWidth	Set/Get	0 to 200
164	Display area	displayRegion	Set/Get	0 to 3,999
165	Noise cancel	noisePointCut	Set/Get	0: OFF, 1: ON
166	Measure type	measureType	Set/Get	0: Projection, 1: Derivation
167	Fix region count	separateType	Set/Get	0: Not fixed, 1: Fixed
168	Edge Level Upper limit	edgeLevelUpper	Set/Get	0 to 100
169	Edge Level Upper limit absolute value	edgeLevelUpperAbs	Set/Get	Color camera: 0 to 442 Monochrome camera: 0 to 255

No.	Data name	Data ident	Set/Get	Data range
170	Monochrome Derivation edge detection mode	diffDetectMode	Set/Get	0: Absolute, 1: Dark → Light, 2: Light → Dark
171	FNC Rate	fncRate	Set/Get	0 to 100
173	Distance	inlierDist	Set/Get	0 to 10,000
174	Compatibility mode (Ver.5.73 or earlier)	compMode	Set/Get	0: OFF, 1: ON
177	Filter Strength	filterStrength	Set/Get	0 to 100
178	Setting unit of reference coordinate	refUnitNo	Set/Get	-1 to 9,999
179	Setting type of reference coordinate	refSettingType	Set/Get	0: Numerical, 1: Unit
180	Use point coordinate before scroll	beforeScrollRefMode	Set/Get	0: Not use, 1: Use
181	Reference X before scroll	beforeScrollRefPosX	Set/Get	-99,999.9999 to 99,999.9999
182	Reference Y before scroll	beforeScrollRefPosY	Set/Get	-99,999.9999 to 99,999.9999
6,002	Format	cameraColor	Set/Get	1: Monochrome camera 2: Color camera
10,100+N (N=0 to 3,999)	Enable/disable region	area_enabled0000 to area_enabled3999	Set/Get	0: Disabled, 1: Enabled
30,000+N (N=0 to 3,999)	Edge Position X	edgePosX0000 to edgePosX3999	Get only	-99,999.9999 to 99,999.9999
40,000+N (N=0 to 3,999)	Edge Position Y	edgePosY0000 to edgePosY3999	Get only	-99,999.9999 to 99,999.9999
90,000	figure0 Count	figArea0_count	Set/Get	0 to 1
90,001	figure0 Type	figArea0_fig0_type	Set/Get	4: Wide line
90,002	figure0 mode	figArea0_fig0_mode	Set/Get	0: OR
90,009	figure0 Wide line Start point X	figAr- ea0_fig0_lineW_X0	Set/Get	-99,999 to 99,999
90,010	figure0 Wide line Start point Y	figAr- ea0_fig0_lineW_Y0	Set/Get	-99,999 to 99,999
90,011	figure0 Wide line End point X	figAr- ea0_fig0_lineW_X1	Set/Get	-99,999 to 99,999
90,012	figure0 Wide line End point Y	figAr- ea0_fig0_lineW_Y1	Set/Get	-99,999 to 99,999
90,013	figure0 Wide line Width	figAr- ea0_fig0_lineW_W	Set/Get	0 to 99,999
90,099	figure0 Update	figArea0_update	Set only	1: Update

2-15 Scan Edge Width

This processing item detects the position of the measurement object by using the change in color within the measurement region. By dividing the measurement region, you can get the following values.

- Local width of the work
- Average width of the work

Used in the Following Case

- When getting several widths of a measurement object:

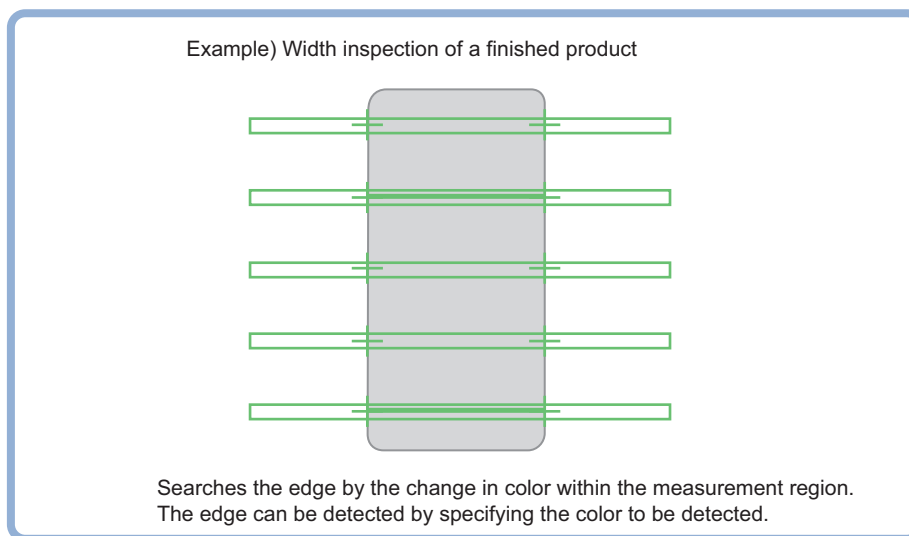

- When getting the width of a measurement object:
Using a Expression, the width of a measurement object can be calculated from the difference between two edge positions.



Precautions for Correct Use

Processing is different for color images and monochrome images. When the camera type used in the previous setup was changed to color or monochrome type, perform the settings again.



Additional Information

Edge processing basic concepts:

For details, refer to *Appendixes Measurement Mechanism Edge Detection Measurement* in the *Vision System FH/FHV Series User's Manual (Cat. No. Z365)*.

2-15-1 Settings Flow (Scan Edge Width)

To set Scan Edge Width, follow the steps below.

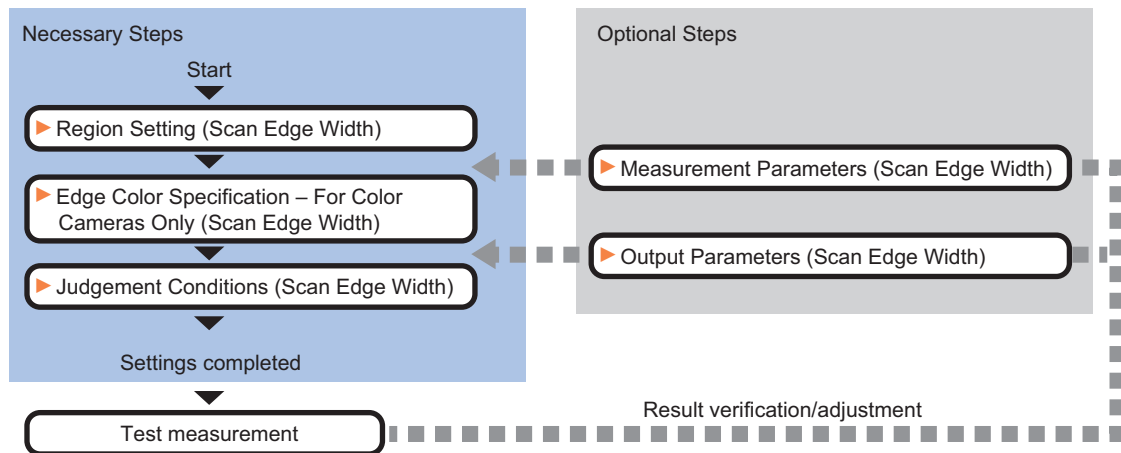

List of Scan Edge Width Items

Item	Description
Region setting	Sets the measurement area. <i>2-15-2 Region Setting (Scan Edge Width) on page 2-221</i>
Edge color (for color cameras only)	This item selects the color of the edges to be detected. If the target color changes, this setting is not necessary. If the color is not specified, positions in the measurement region where the color changes drastically are detected as an edge. <i>2-15-3 Edge Color Specification - For Color Cameras Only (Scan Edge Width) on page 2-223</i>
Measurement parameter	Measurement parameter can be changed as needed to address unstable measurement results. The displayed items depend on whether your camera is a color or monochrome camera. Normally, the factory default value will be used. <i>2-15-4 Measurement Parameters (Scan Edge Width) on page 2-224</i>
Judgment condition	Sets processing conditions for measurement and judgment conditions for measurement results. <i>2-15-5 Judgment Conditions (Scan Edge Width) on page 2-227</i>
Output parameter	This item can be changed as necessary. Normally, the factory default value will be used. Use the output parameter to specify how to handle the coordinates. <i>2-15-6 Output Parameters (Scan Edge Width) on page 2-228</i>

2-15-2 Region Setting (Scan Edge Width)

This item is used to set up the measurement area.

Specify the measurement region for *Scan Edge Width* by using wide straight lines.

- 1** In the Item tab area, click **Region setting**.
- 2** Use the Drawing tools to specify the measurement region.
To align with the measurement area and change the number of measurement points, uncheck this.

If the width of the measurement region is changed with the checkbox unchecked, the number of measurement points in Scan-sub-region is changed to minimize the amount of change of the scanned region interval.

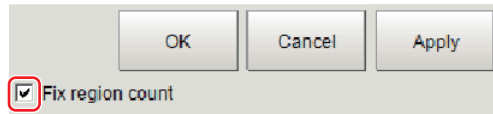

- 3** Click **OK** in the *Figure setting* area.
 - **OK**: Changes the settings and returns to the previous menu.
 - **Cancel**: Changes are discarded. Returns to the previous menu.
 - **Apply**: Updates the settings without leaving edit window.
- 4** Set the measurement point and the filter size for the region.

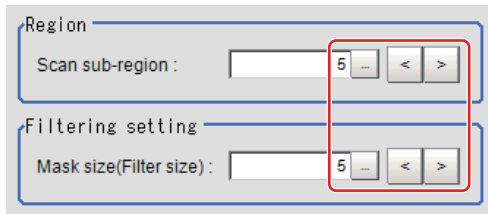

Setting item	Setting value [Factory default]	Description
Scan sub-region	1 to 4,000 [5]	Set the measurement point for the region.
Mask size	0 to 200 [5]	Set the filter size when smoothing the measurement point vicinity. When 5 is set, smoothing is processed for a total of 11 points: the measurement point and the 5 pixels before and after it.

- 5** The region is divided equally.

Division of Scan Area

The scan region, when the number of measurement points is 1

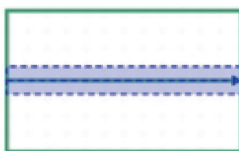

The scan region, when the number of measurement points is 2



The scan region, when the number of measurement points is 3



The scan region, when the number of measurement points is 4

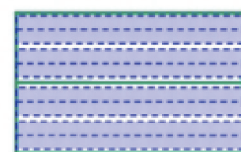

- 6** Perform the display setting if required.
Placing a check at *Filtered image* makes it easier to change the filtering setting.

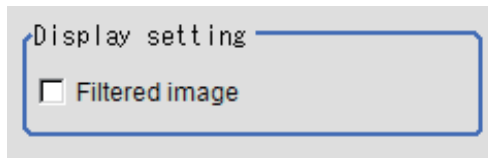

Setting item	Setting value [Factory default]	Description
Filtered image	<ul style="list-style-type: none"> • Checked • [Unchecked] 	If checked, the filtered image of the ranges set with the <i>Scan sub-region</i> and <i>Mask size</i> after smoothing is displayed.



Additional Information

You can specify enable/disable for each edge measurement number. Clicking edge measurement points displays the following screen.

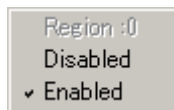

2-15-3 Edge Color Specification - For Color Cameras Only (Scan Edge Width)

This item selects the color of the edges to be detected.

If the target color changes, this setting is not necessary. If the color is not specified, positions in the measurement region where the color changes drastically are detected as an edge.

- 1 In the Item tab area, click **Edge color**.
- 2 Place a check at *Edge color specification* in the *Color setting* area.

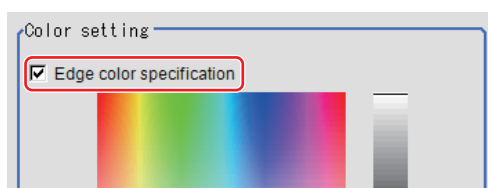

- 3 Select the color to detect as edges.

Setting item	Setting value [Factory default]	Description
Image Display area	-	Specify a region on the image that includes the target color. The average color of the specified region is registered.
Color chart	-	Click the reference color on the color chart to specify it. The RGB values for the specified color are displayed at the bottom.
R, G, B	0 to 255 [255]	The color to be detected is set with the RGB values.

Setting item	Setting value [Factory default]	Description
Difference R, G, B	0 to 127 [5]	This sets the allowable color difference for detecting the edge, using the specified color as the reference. The larger the difference values, the larger the color range that is used to detect the edge.
Detection mode	<ul style="list-style-type: none"> [Color IN] Color OUT 	<ul style="list-style-type: none"> Color IN: The position where a color other than the specified color changes to the specified color is detected as the edge. Color OUT: The position where the specified color changes to a color other than the specified color is detected as the edge. <div style="display: flex; justify-content: space-around; align-items: flex-start;"> <div style="text-align: center;"> <p>For "Color IN" edge measurement mode</p> </div> <div style="text-align: center;"> <p>For "Color OUT" edge measurement mode</p> </div> </div> <div style="display: flex; justify-content: space-around; align-items: flex-start; margin-top: 20px;"> <div style="text-align: center;"> <p>For "Color IN" edge measurement mode</p> </div> <div style="text-align: center;"> <p>For "Color OUT" edge measurement mode</p> </div> </div>

2-15-4 Measurement Parameters (Scan Edge Width)

Measurement parameters can be changed as needed to address unstable measurement results. Normally, the factory default value will be used.

After changing a setting, check whether measurement can be done properly by performing an actual measurement.

- 1 In the Item tab area, click **Measurement**.
The edge profile of the measurement region is displayed as a graph in the *Image Display* area.

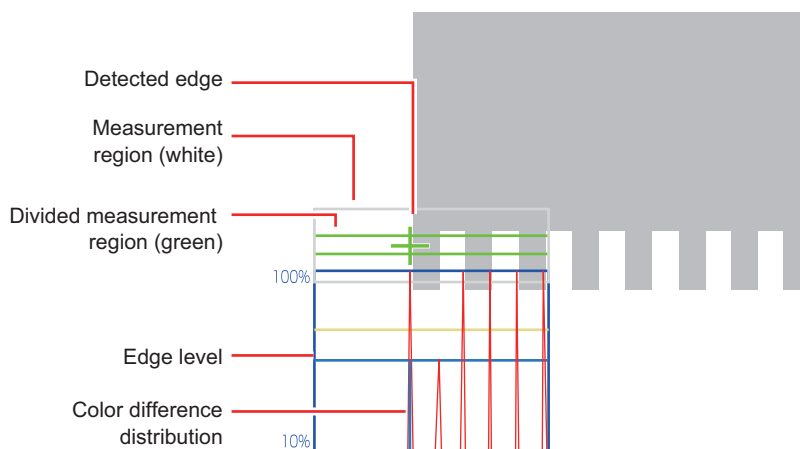

- 2 Set the value of each item in the *Display position* area.

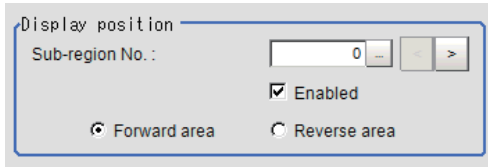

Setting item	Setting value [Factory default]	Description
Sub-region No.	0 to 9,999 [0]	Specify the <i>Sub-region No.</i> for which the edge profile is displayed.
Enabled	<ul style="list-style-type: none"> [Checked] Unchecked 	Specify enable/disable for the displayed <i>Sub-region No.</i> . When disabled (unchecked) is specified, that <i>Sub-region No.</i> is not measured.
Forward area Reverse area	<ul style="list-style-type: none"> [Forward area] Reverse area 	<ul style="list-style-type: none"> Forward area: The edge is searched for from the start point of the area toward the end point. Reverse area: The edge is searched for from the end point of the area toward the start point.

3 If necessary, specify a value for each item in the *Measurement condition* area.

- For color cameras:

Edge Color Not Specified

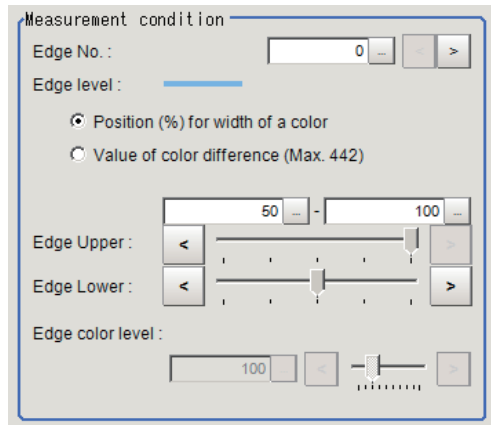

Edge Color Specified

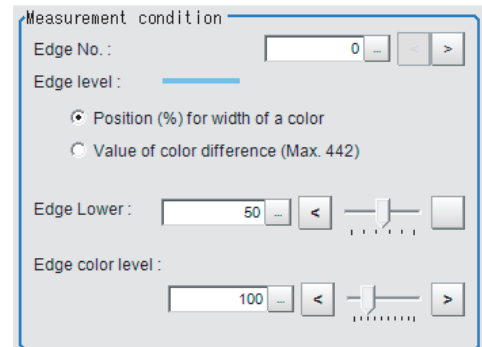

Setting item	Setting value [Factory default]	Description
Edge No.	0 to 99 [0]	Specify the edge number used to extract edges. <i>Edge numbers</i> are assigned to detected edges starting from 0 and going on in the direction from the start point (the arrow point) to the end point (the direction of arrow) in the selected area.
Edge Upper (only when edge color is not specified) Edge Lower	<ul style="list-style-type: none"> Position (%) for width of a color 0 to 100 [50] to [100] Value of color 0 to 442 [20] to [442] 	Set a range of a color difference level with which the edge is detected. For details, refer to <i>Appendixes Measurement Mechanism Edge Detection Measurement</i> in the <i>Vision System FH/FHV Series User's Manual (Cat. No. Z365)</i> .
Edge color level	0 to 442 [100]	This emphasis level can be specified only if the edge color to detect is specified.

- For monochrome cameras:

When the *Measurement type* is *Projection*:

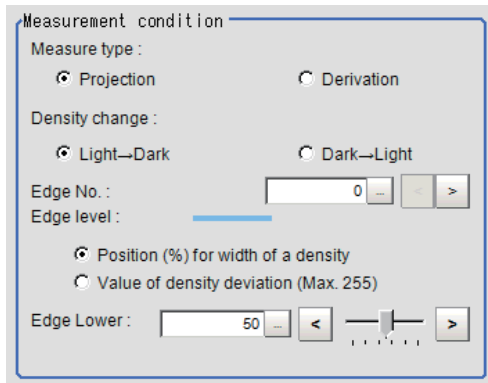

When the *Measurement type* is *Derivation*:

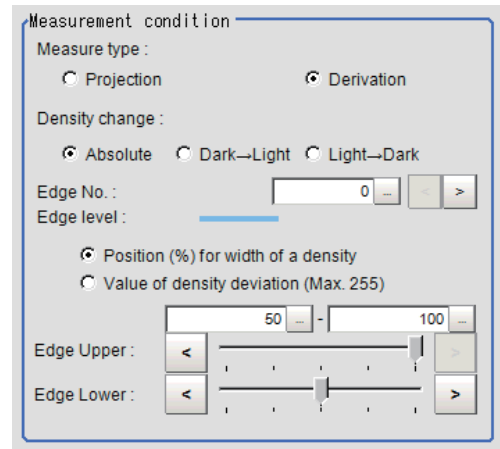

Setting item	Setting value [Factory default]	Description
Measure type	<ul style="list-style-type: none"> • [Projection] • Derivation 	<p>As the <i>Measurement type</i>, specify either <i>Projection</i> or <i>Derivation</i>.</p> <p>For details, refer to <i>Appendixes Measurement Mechanism Edge Detection Measurement</i> in the <i>Vision System FH/FHV Series User's Manual (Cat. No. Z365)</i>.</p>
Density change	<ul style="list-style-type: none"> • Absolute (only when the <i>Measure type</i> is <i>Derivation</i>) • [Dark → Light] • Light → Dark 	<p>Select whether a black-to-white change or a white-to-black change should be recognized as a density change in the specified region.</p>
Edge No.	0 to 99 [0]	<p>Specify the edge number used to extract edges.</p> <p><i>Edge numbers</i> are assigned to detected edges starting from 0 and going on in the direction from the start point (the arrow point) to the end point (the direction of arrow) in the selected area.</p>
Edge Upper Edge Lower	<ul style="list-style-type: none"> • Position (%) for width of a density 0 to 100 [50] to [100] • Value of density 0 to 255 [20] to [255] 	<p>Select the density change level to be detected as edges.</p> <p>The upper limit of edges can be set only when the <i>Measure type</i> is <i>Derivation</i>.</p> <p>For details, refer to <i>Appendixes Measurement Mechanism Edge Detection Measurement</i> in the <i>Vision System FH/FHV Series User's Manual (Cat. No. Z365)</i>.</p>

4 If necessary, set each item in the *Noise removal* area.

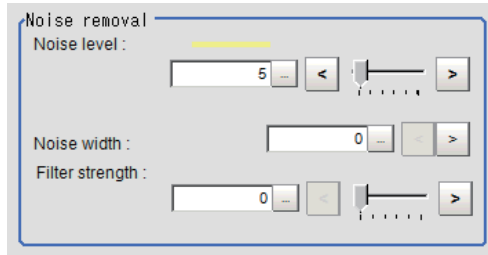

Setting item	Setting value [Factory default]	Description
Noise level	<ul style="list-style-type: none"> For color cameras: 0 to 442 [5] For monochrome cameras: 0 to 255 [5] 	When edges are incorrectly detected due to noise, increase this value. For details, refer to <i>Appendixes Measurement Mechanism Edge Detection Measurement</i> in the <i>Vision System FH/FHV Series User's Manual (Cat. No. Z365)</i> .
Noise width	0 to 9,999 [0]	Set the width for judging noise. When detection is affected by noise, increase this value. For details, refer to <i>Appendixes Measurement Mechanism Edge Detection Measurement</i> in the <i>Vision System FH/FHV Series User's Manual (Cat. No. Z365)</i> .
Filter strength	0 to 100 [0]	If a valley appears in the histogram around the edge threshold value due to noises, smoothen the edge profile using a filter to prevent wrong error detection from being detected. Strengthening the filter smoothen the edge profile further.

2-15-5 Judgment Conditions (Scan Edge Width)

Specify the range to be judged as OK.

- 1 In the Item Tab area click **Judgment**.
- 2 Set up the judgment condition.



Additional Information

The values beside each item are measurement results of the displayed image. Take these values into consideration to determine the upper and lower limit values.

Setting item	Setting value	Description
Edge width Max.	0 to 99,999.9999	Specify the upper and lower limits of the maximum width judged to be OK.
Edge width Min.	0 to 99,999.9999	Specify the upper and lower limits of the minimum width judged to be OK.
Edge width Ave.	0 to 99,999.9999	Specify the upper and lower limits of the average width judged to be OK.
Lost width count	0 to 100	Specify the upper and lower limits of the lost width count judged to be OK.

2-15-6 Output Parameters (Scan Edge Width)

Specify how to treat the coordinates to be output to the external device as measurement results. This item can be changed if necessary. Normally, the factory default value will be used.



Precautions for Correct Use

After setting up the measurement parameters, changing the output parameters will cause measurement results to vary accordingly. If the output parameters have been changed, re-specify the measurement, too.

- 1 Click **Output parameter** in the Item tab area.
- 2 Specify each of the following items.

Setting item	Setting value [Factory default]	Description
Output coordinates	<ul style="list-style-type: none"> • [After scroll] • Before scroll 	As measurement results, select whether to output coordinate values to external devices before or after the position deflection correction is applied.
Calibration	<ul style="list-style-type: none"> • ON • [OFF] 	Select whether to reflect the calibration in the values output to the external device as measurement results. <ul style="list-style-type: none"> • ON: Output the coordinates converted into actual dimensions. • OFF: Output the camera coordinate values.
Reflect to overall judgment	<ul style="list-style-type: none"> • [ON] • OFF 	Enables choosing whether or not the judgement results of this processing unit is reflected in the scene overall judgment.



Additional Information

For output coordinates and calibration, refer to *Appendixes Measurement Mechanism Handling Coordinates* in the *Vision System FH/FHV Series User's Manual (Cat. No. Z365)*.

2-15-7 Key Points for Test Measurement and Adjustment (Scan Edge Width)

The following content is displayed in the *Detail result* area as text.

Displayed item	Description
Judge	Judgment results 0: No judgment (unmeasured) 1: Judgment result OK -1: Judgment result NG -10: Error (image format mismatch) -11: Error (unregistered model) -12: Error (insufficient memory) -20: Error (other errors)
Edge width Max.	The maximum value of edge width
Edge width Min.	The minimum value of edge width
Edge width Ave.	The average value of all the edge width
Lost width count	The number of the scanned areas for which the detection of width failed

The image specified in the Sub-image number in the image display setting is displayed in the *Image Display* area.

Sub-image number	Description of image to be displayed
0	Measurement image
1	Scan region

Key Points for Adjustment (Scan Edge Width)

Adjust the setting parameters referring to the following points.

● When the measurement results are unstable

Parameter to be adjusted	Remedy
Measurement parameter	When the color of the edges to be detected is decided, specify the color with <i>Edge color</i> . If results are not stable even with the color specified, specify a larger value for the color variance range. If noise is detected as an edge, specify larger values for <i>Noise level</i> and <i>Noise width</i> .

2-15-8 Measurement Results for Which Output Is Possible (Scan Edge Width)

The following values can be output using processing items related to result output. It is also possible to reference measurement values from calculation expressions and other processing units.

Measurement items	Character string	Description
Judge	JG	Judgment results 0: No judgment (unmeasured) 1: Judgment result OK -1: Judgment result NG -10: Error (image format mismatch) -11: Error (unregistered model) -12: Error (insufficient memory) -20: Error (other errors)
Edge width Max.	MAXW	The maximum value of edge width
Edge width Min.	MINW	The minimum value of edge width
Edge width Ave.	AVEW	The average value of all the edge width
Lost width count	LOST	The number of the scanned areas for which the detection of width failed



Precautions for Correct Use

Note that if X and Y magnifications are not the same in the camera calibration, the edge width will not be measured correctly.

2-15-9 External Reference Tables (Scan Edge Width)

No.	Data name	Data ident	Set/Get	Data range
0	Judge	judge	Get only	0: No judgment (unmeasured), 1: Judgment result OK, -1: Judgment result NG, -10: Error (image format mismatch), -11: Error (unregistered model), -12: Error (insufficient memory), -20: Error (other errors)
1	Edge width Max.	width_max	Get only	0 to 99,999.9999
2	Edge width Min.	width_min	Get only	0 to 99,999.9999
3	Edge width Ave.	width_ave	Get only	0 to 99,999.9999
4	Lostwidth	lostPoint	Get only	0 to 4,000
101	Output coordinates	outputCoordinate	Set/Get	0: After scroll, 1: Before scroll
102	Calibration	calibration	Set/Get	0: OFF, 1: ON
103	Reflect to overall judgement	overallJudge	Set/Get	0: ON, 1: OFF
120	Edge color specification	colorSpecification	Set/Get	0: OFF, 1: ON
121	Edge color R	colorR	Set/Get	0 to 255
122	Edge color G	colorG	Set/Get	0 to 255
123	Edge color B	colorB	Set/Get	0 to 255
124	Difference R	colorDevR	Set/Get	0 to 127
125	Difference G	colorDevG	Set/Get	0 to 127
126	Difference B	colorDevB	Set/Get	0 to 127
127	Detection mode	detectionMode	Set/Get	0: Color IN, 1: Color OUT
129	Edge Level Lower limit	edgeLevel	Set/Get	0 to 100
130	Noise level	noiseLevel	Set/Get	Color camera: 0 to 442 Monochrome camera: 0 to 255
131	Noise width	noiseWidth	Set/Get	0 to 9,999
132	Edge color level	colorLevel	Set/Get	0 to 442
133	Upper limit of the Max. width	upperMaxWidth	Set/Get	0 to 99,999.9999
134	Lower limit of the Max. width	lowerMaxWidth	Set/Get	0 to 99,999.9999
135	Upper limit of the Min.width	upperMinWidth	Set/Get	0 to 99,999.9999
136	Lower limit of the Min.width	lowerMinWidth	Set/Get	0 to 99,999.9999
137	Upper limit of the average width	upperAveWidth	Set/Get	0 to 99,999.9999
138	Lower limit of the average width	lowerAveWidth	Set/Get	0 to 99,999.9999
139	Upper limit of the lostwidth	upperLostPoint	Set/Get	0 to 4,000

No.	Data name	Data ident	Set/Get	Data range
140	Lower limit of the lostwidth	lowerLostPoint	Set/Get	0 to 4,000
141	Monochrome edge detection mode	monoDetectMode	Set/Get	0: Light → Dark, 1: Dark → Light
142	Edge level Lower limit absolute value	edgeLevelAbs	Set/Get	Color camera: 0 to 442 Monochrome camera: 0 to 255
143	Edge level specification method	edgeLevelKind	Set/Get	0: %, 1: Absolute value
145	Scan sub-region	scanLines	Set/Get	1 to 4,000
146	Mask size(Filter size)	scanWidth	Set/Get	0 to 200
147	Display area	displayRegion	Set/Get	0 to 3,999
148	Display area(direction)	displayRegionDir	Set/Get	0: Forward, 1: Reverse
149	Measure type	measureType	Set/Get	0: Projection, 1: Derivation
150	Fix region count	separateType	Set/Get	0: Not fixed, 1: Fixed
151	Monochrome Derivation edge detection mode	diffDetectMode	Set/Get	0: Absolute, 1: Dark → Light, 2: Light → Dark,
152	Edge Level Upper limit	edgeLevelUpper	Set/Get	0 to 100
153	Edge level Upper limit absolute value	edgeLevelUpperAbs	Set/Get	Color camera: 0 to 442 Monochrome camera: 0 to 255
154	Filter Strength	filterStrength	Set/Get	0 to 100
6,002	Format	cameraColor	Set/Get	1: Monochrome camera 2: Color camera
10,100+N (N=0 to 3,999)	Enable/disable region	area_enabled0000 to area_enabled3999	Set/Get	0: Disabled, 1: Enabled
30,000+N (N=0 to 3,999)	Start Edge Position X	SedgePosX0000 to SedgePosX3999	Get only	-99,999.9999 to 99,999.9999
40,000+N (N=0 to 3,999)	Start Edge Position Y	SedgePosY0000 to SedgePosY3999	Get only	-99,999.9999 to 99,999.9999
50,000+N (N=0 to 3,999)	End Edge Position X	EedgePosX0000 to EedgePosX3999	Get only	-99,999.9999 to 99,999.9999
60,000+N (N=0 to 3,999)	End Edge Position Y	EedgePosY0000 to EedgePosY3999	Get only	-99,999.9999 to 99,999.9999
90,000	figure0 Count	figArea0_count	Set/Get	0 to 1
90,001	figure0 Type	figArea0_fig0_type	Set/Get	4: Wide line
90,002	figure0 mode	figArea0_fig0_mode	Set/Get	0: OR
90,009	figure0 Wide line Start point X	figArea0_fig0_lineW_X0	Set/Get	-99,999 to 99,999
90,010	figure0 Wide line Start point Y	figArea0_fig0_lineW_Y0	Set/Get	-99,999 to 99,999
90,011	figure0 Wide line End point X	figArea0_fig0_lineW_X1	Set/Get	-99,999 to 99,999
90,012	figure0 Wide line End point Y	figArea0_fig0_lineW_Y1	Set/Get	-99,999 to 99,999
90,013	figure0 Wide line Width	figArea0_fig0_lineW_W	Set/Get	0 to 99,999

No.	Data name	Data ident	Set/Get	Data range
90,099	figure0 Update	figArea0_update	Set only	1: Update

2-16 Circular Scan Edge Position

This processing item detects the position of the circular measurement object by using the change in color within the measurement region.

Used in the Following Case

To obtain the center of the circle and the radius from multiple edges of a circular measurement object:

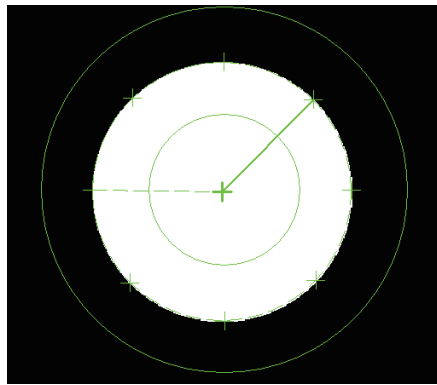

Searches the edge with the change in color within the measurement region.
The edge can be detected by specifying the color to be detected.



Precautions for Correct Use

Processing is different for color images and monochrome images. When the camera type used in the previous setup was changed to color or monochrome type, perform the settings again.



Additional Information

Edge processing basic concepts:
For details, refer to *Appendixes Measurement Mechanism Edge Detection Measurement* in the *Vision System FH/FHV Series User's Manual (Cat. No. Z365)*.

2-16-1 Settings Flow (Circular Scan Edge Position)

To set Circular Scan Edge Position, follow the steps below.

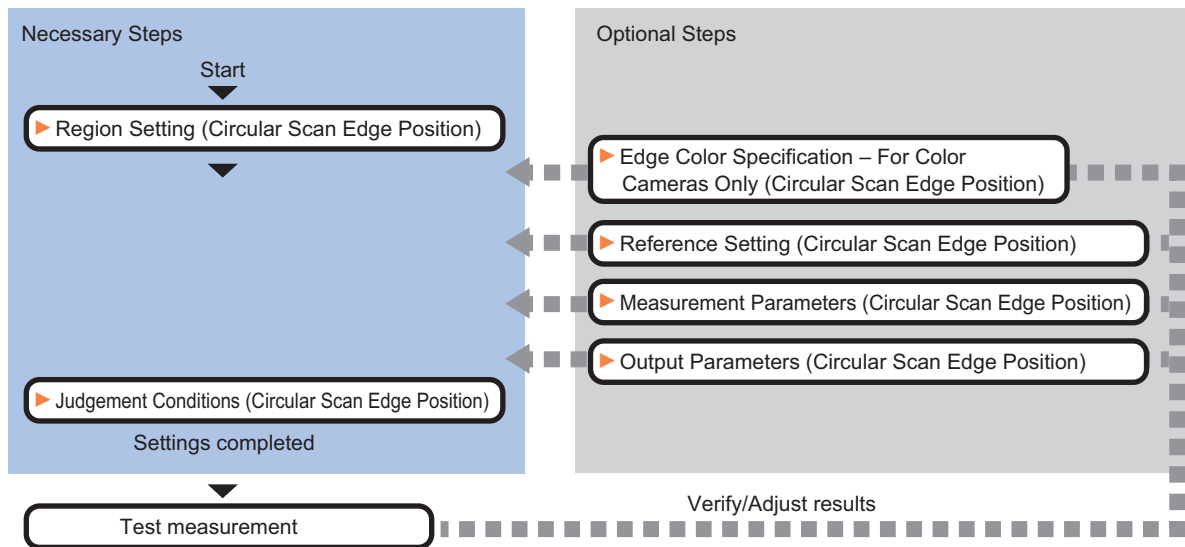

List of Circular Scan Edge Position Items

Item	Description
Region setting	Sets the measurement area. <i>2-16-2 Region Setting (Circular Scan Edge Position) on page 2-235</i>
Edge color (for color cameras only)	This item selects the color of the edges to be detected. If the target color changes, this setting is not necessary. If the color is not specified, positions in the measurement region where the color changes drastically are detected as an edge. <i>2-16-3 Edge Color Specification - For Color Cameras Only (Circular Scan Edge Position) on page 2-236</i>
Ref. setting	This item can be changed as necessary. Specify the reference position within the camera's field of view. <i>2-16-4 Reference Setting (Circular Scan Edge Position) on page 2-237</i>
Measurement parameter	Measurement parameter can be changed as needed to address unstable measurement results. The displayed items depend on whether your camera is a color or monochrome camera. Normally, the factory default value will be used. <i>2-16-5 Measurement Parameters (Circular Scan Edge Position) on page 2-239</i>
Judgment condition	Sets processing conditions for measurement and judgment conditions for measurement results. <i>2-16-6 Judgment Conditions (Circular Scan Edge Position) on page 2-242</i>
Output parameter	This item can be changed as necessary. Normally, the factory default value will be used. Use the output parameter to specify how to handle the coordinates. <i>2-16-7 Output Parameters (Circular Scan Edge Position) on page 2-243</i>

2-16-2 Region Setting (Circular Scan Edge Position)

This item is used to set up the measurement area.

Specify the measurement region for *Circular Scan Edge Position* by using circular or wide arc shapes.

- 1 In the Item tab area, click **Region setting**.
- 2 Use the Drawing tools to specify the measurement region.
To align with the measurement area and change the number of measurement points, uncheck this.

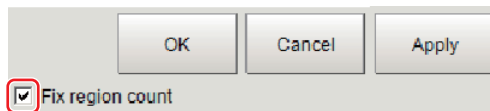

- 3 Click **OK** in the *Figure setting* area.
 - **OK**: Changes the settings and returns to the previous menu.
 - **Cancel**: Changes are discarded. Returns to the previous menu.
 - **Apply**: Updates the settings without leaving edit window.
- 4 Specify the method of measurement, the measurement point, and the start angle for the region.

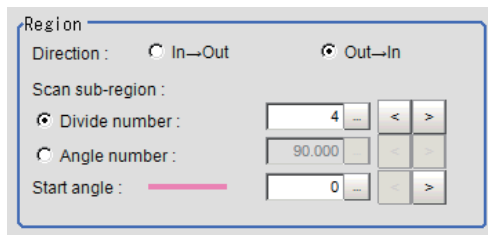

Setting item	Setting value [Factory default]	Description
Direction	<ul style="list-style-type: none"> • [Out → In] • In → Out 	Set the measurement direction.
Scan sub-region	<ul style="list-style-type: none"> • [Divide number] • Angle number 	Set the measurement point. Use either the <i>Divide number</i> or the <i>Angle number</i> for this setting.
Divide number	3 to 3,600 [4]	Set the number of divisions for the circle. The specified value is used as the measurement point.
Angle number	1.000 to 179.999 [90.000]	Set the skipping angle for the circle. The measurement point is determined based on the specified angle.
Start angle	0 to 359 [0]	Set the start angle to specify a region.

- 5 Set the mask size for the region.

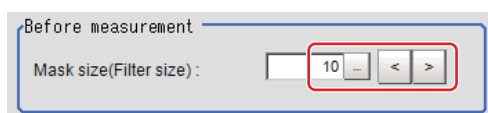

Setting item	Setting value [Factory default]	Description
Mask size	0 to 1,000 [10]	Set the filter size when smoothing the measurement point vicinity. When 5 is set, smoothing is processed for a total of 11 points: the measurement point and the 5 pixels before and after it.

- 6** Perform the display setting if required.
Placing a check at *Filtered image* makes it easier to change the filtering setting.

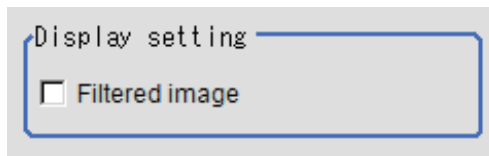

Setting item	Setting value [Factory default]	Description
Filtered image	<ul style="list-style-type: none"> • Checked • [Unchecked] 	If checked, the filtered image of the ranges set with the <i>Scan sub-region</i> and <i>Mask size</i> after smoothing is displayed.



Additional Information

You can specify enable/disable for each edge measurement number. Clicking edge measurement points displays the following screen.

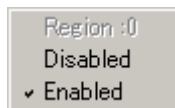

2-16-3 Edge Color Specification - For Color Cameras Only (Circular Scan Edge Position)

This item selects the color of the edges to be detected.

If the target color changes, this setting is not necessary. If the color is not specified, positions in the measurement region where the color changes drastically are detected as an edge.

- 1** In the Item tab area, click **Edge color**.
- 2** Place a check at *Edge color specification* in the *Color setting* area.

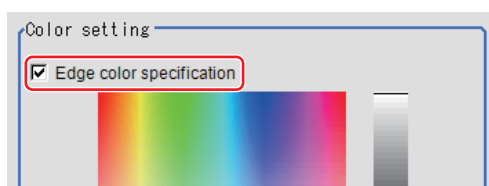

- 3** Select the color to detect as edges.

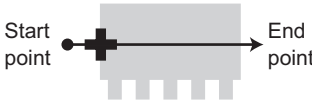
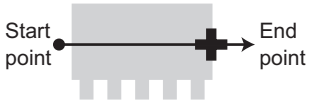
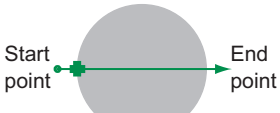
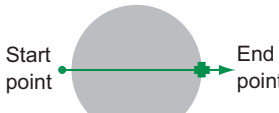
Setting item	Setting value [Factory default]	Description
Image Display area	-	Specify a region on the image that includes the target color. The average color of the specified region is registered.
Color chart	-	Click the reference color on the color chart to specify it. The RGB values for the specified color are displayed at the bottom.
R, G, B	0 to 255 [255]	The color to be detected is set with the RGB values.
Difference R, G, B	0 to 127 [5]	This sets the allowable color difference for detecting the edge, using the specified color as the reference. The larger the difference values, the larger the color range that is used to detect the edge.
Detection mode	<ul style="list-style-type: none"> • [Color IN] • Color OUT 	<ul style="list-style-type: none"> • Color IN: The position where a color other than the specified color changes to the specified color is detected as the edge. • Color OUT: The position where the specified color changes to a color other than the specified color is detected as the edge. <div style="display: flex; justify-content: space-around; align-items: flex-start;"> <div style="text-align: center;">  <p>For "Color IN" edge measurement mode</p> </div> <div style="text-align: center;">  <p>For "Color OUT" edge measurement mode</p> </div> </div> <div style="display: flex; justify-content: space-around; align-items: flex-start; margin-top: 20px;"> <div style="text-align: center;">  <p>For "Color IN" edge measurement mode</p> </div> <div style="text-align: center;">  <p>For "Color OUT" edge measurement mode</p> </div> </div>

2-16-4 Reference Setting (Circular Scan Edge Position)

When the model is set, this position is automatically set at the same time as the reference position.

This item can be set to change the reference position to any desired position. This is handy for measuring the position deviation from a certain position.

A reference position can be set either directly or by referencing a unit.

Specifying directly

Click a position on the image you want to use as a reference position, or input coordinate data for that point.

- 1 In the Item tab area, click **Ref. setting**.
In the *Display* area, the current reference position will be displayed as the crosshair cursor.

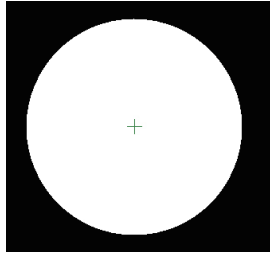

- 2** In the *Method* area, select *Numerical*.

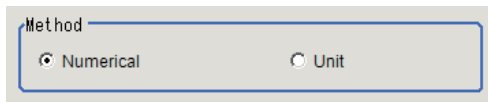

- 3** Click the position to be set as the reference.



Additional Information

Displaying the image enlarged makes this clicking easier.
For details, refer to *Appendixes Basic Knowledge about Operations Using the Zoom Function* in the *Vision System FH/FHV Series User's Manual* (Cat. No. Z365).

- 4** Make fine adjustments using numeric value inputs or the arrow buttons as required.

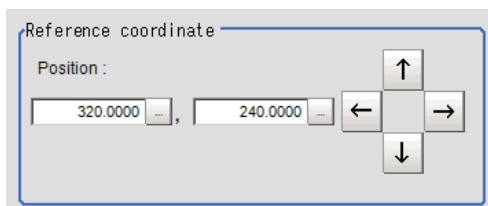

- 5** To remeasure on the displayed image and set the reference, click the **Measure ref.** button.

- 6** To use data before position compensation for the reference setting coordinates, place a check at *Use point coordinate before scroll*.

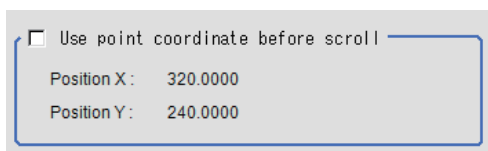

Referencing a Unit

Set a reference by referencing a detection point unit with registered X coordinate, Y coordinate and angle data.

- 1** In the *Item* tab area, click **Ref. setting**.
In the *Display* area, the current reference position will be displayed as the crosshair cursor.

2 In the *Method* area, select *Unit*.

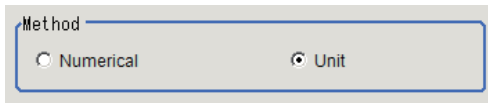

3 In the *Unit* area, select a detection point unit in the scene.

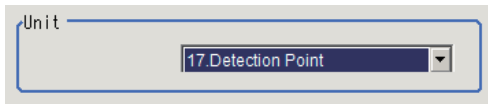

Performing the next measurement will display the reference.

2-16-5 Measurement Parameters (Circular Scan Edge Position)

Measurement parameters can be changed as needed to address unstable measurement results. Normally, the factory default value will be used.

After changing a setting, check whether measurement can be done properly by performing an actual measurement.

1 In the Item tab area, click **Measurement**.

2 Set the value of each item in the *Display position* area.

The edge profile of the measurement region is displayed as a graph in the *Image Display* area.

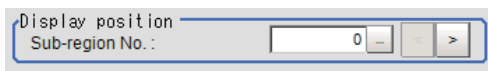

Setting item	Setting value [Factory default]	Description
Sub-region No.	0 to 3,599 [0]	Specify the <i>Sub-region No.</i> for which the edge profile is displayed.

3 If necessary, specify a value for each item in the *Measurement condition* area.

- For color cameras:

Edge Color Not Specified

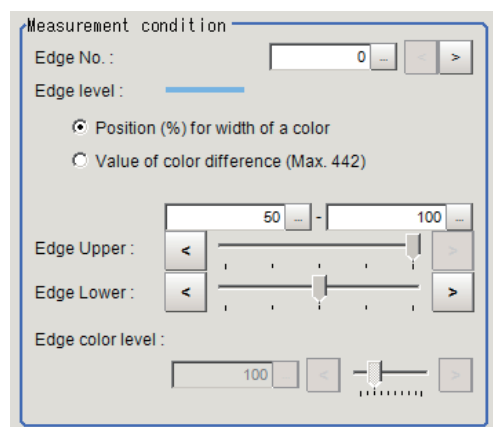

Edge Color Specified

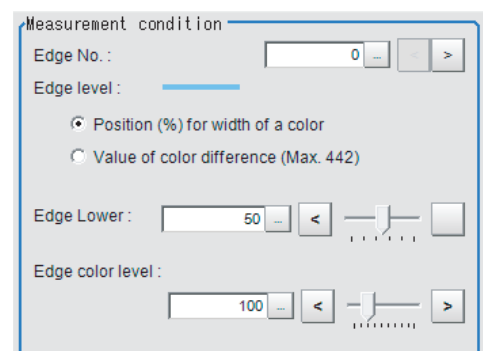

Setting item	Setting value [Factory default]	Description
Edge No.	0 to 99 [0]	Specify the edge number used to extract edges. <i>Edge numbers</i> are assigned to detected edges starting from 0 and going on in the direction from the start point (the arrow point) to the end point (the direction of arrow) in the selected area.
Edge Upper (only when edge color is not specified) Edge Lower	<ul style="list-style-type: none"> Position (%) for width of a color 0 to 100 [50] to [100] Value of color 0 to 442 [20] to [442] 	Set a range of a color difference level with which the edge is detected. For details, refer to <i>Appendixes Measurement Mechanism Edge Detection Measurement</i> in the <i>Vision System FH/FHV Series User's Manual (Cat. No. Z365)</i> .
Edge color level	0 to 442 [100]	This emphasis level can be specified only if the edge color to detect is specified.

- For monochrome cameras:

When the *Measurement type* is *Projection*:

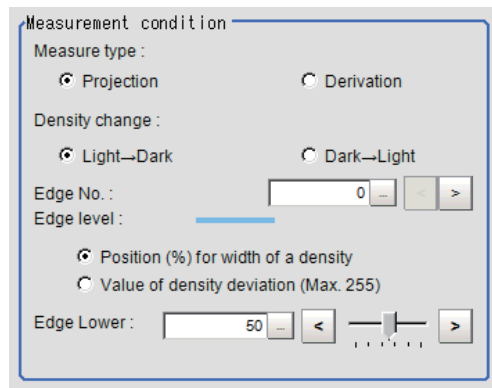

When the *Measurement type* is *Derivation*:

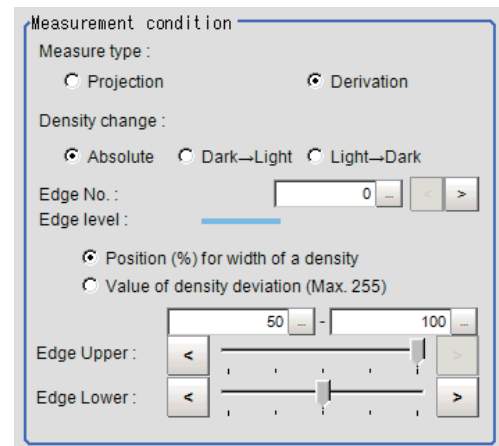

Setting item	Setting value [Factory default]	Description
Measure type	<ul style="list-style-type: none"> [Projection] Derivation 	As the <i>Measurement type</i> , specify either <i>Projection</i> or <i>Derivation</i> . For details, refer to <i>Appendixes Measurement Mechanism Edge Detection Measurement</i> in the <i>Vision System FH/FHV Series User's Manual (Cat. No. Z365)</i> .
Density change	<ul style="list-style-type: none"> Absolute (only when the <i>Measure type</i> is <i>Derivation</i>) [Dark → Light] Light → Dark 	Select whether a black-to-white change or a white-to-black change should be recognized as a density change in the specified region.
Edge No.	0 to 99 [0]	Specify the edge number used to extract edges. <i>Edge numbers</i> are assigned to detected edges starting from 0 and going on in the direction from the start point (the arrow point) to the end point (the direction of arrow) in the selected area.

Setting item	Setting value [Factory default]	Description
Edge Upper Edge Lower	<ul style="list-style-type: none"> Position (%) for width of a density 0 to 100 [50] to [100] Value of density 0 to 255 [20] to [255] 	Select the density change level to be detected as edges. The upper limit of edges can be set only when the <i>Measure type</i> is <i>Derivation</i> . For details, refer to <i>Appendixes Measurement Mechanism Edge Detection Measurement</i> in the <i>Vision System FH/FHV Series User's Manual (Cat. No. Z365)</i> .

4 If necessary, set each item in the *Noise removal* area.

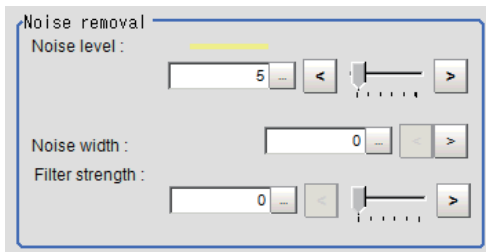

Setting item	Setting value [Factory default]	Description
Noise level	<ul style="list-style-type: none"> For color cameras: 0 to 442 [5] For mono-chrome cameras: 0 to 255 [5] 	When edges are incorrectly detected due to noise, increase this value. For details, refer to <i>Appendixes Measurement Mechanism Edge Detection Measurement</i> in the <i>Vision System FH/FHV Series User's Manual (Cat. No. Z365)</i> .
Noise width	0 to 9,999 [0]	Set the width for judging noise. When detection is affected by noise, increase this value. For details, refer to <i>Appendixes Measurement Mechanism Edge Detection Measurement</i> in the <i>Vision System FH/FHV Series User's Manual (Cat. No. Z365)</i> .
Filter strength	0 to 100 [0]	If a valley appears in the histogram around the edge threshold value due to noises, smoothen the edge profile using a filter to prevent wrong error detection from being detected. Strengthening the filter smoothen the edge profile further.

5 In the Sub-region detail area, set enable or disable measurement as required.

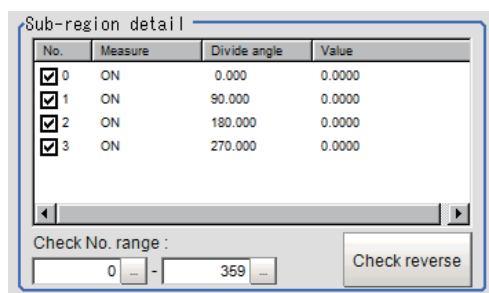

Setting item	Setting value [Factory default]	Description
Check No. range	0 to 3,599 [0] to [3,599]	Specify the edge measurement number for which to perform batch reversing of the enable or disable measurement setting. Click Check reverse to reverse the check box settings of the edge measurement number within the range.

2-16-6 Judgment Conditions (Circular Scan Edge Position)

Specify the range to be judged as OK.

- 1 In the circle calculation parameter, set the calculation method as required.

Setting item	Setting value [Factory default]	Description
Calc parameter	<ul style="list-style-type: none"> • [Approximation circle] • Smallest enclosing circle 	Specify the circle calculation method. When the calculation from the smallest enclosing circle is selected, specify fast speed or high precision.
	<ul style="list-style-type: none"> • [Fast] • Precision 	
Removed area num	0 to 3,600 [0]	Set the number of regions to remove. The differences from the circular regression calculated from all measurement points are eliminated in the order of the largest to the smallest. *1
Compatibility mode (Ver.5.73 or earlier)	<ul style="list-style-type: none"> • Checked • [Unchecked] 	Sets the compatible mode for "Noise cancel". Check this when scene data before Ver.5.73 was loaded.
Distance (pix)	0 to 10,000 [5]	Specify the degree of "Noise cancel" with a distance (pixel) to the approximation circle.*2

*1. *Compatibility mode (Ver.5.73 or earlier)* is checked in *Approximation circle* or *Fast* in *Smallest enclosing circle* is selected, this is displayed.

*2. *Compatibility mode (Ver.5.73 or earlier)* is not checked in *Approximation circle*, this is displayed.

Approximation circle is selected in *Method* and *Compatibility mode (Ver. 5.73 or earlier)*.

Smallest enclosing circle is selected in *Method* and *Fast* is selected.

Approximation circle is selected in *Method* and *Compatibility mode* is checked.

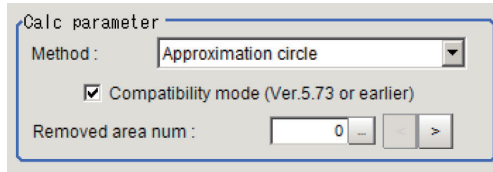

- 2 Set up the judgment condition.



Additional Information

The values beside each item are measurement results of the displayed image. Take these values into consideration to determine the upper and lower limit values.

Setting item	Setting value	Description
Center X	-99,999.9999 to 99,999.9999	Set the range of center coordinate Xs that are judged to be OK.
Center Y	-99,999.9999 to 99,999.9999	Set the range of center coordinate Ys that are judged to be OK.
Radius	0 to 99,999.9999	Set the range of radiuses that is judged to be OK.
Radius Max.	0 to 99,999.9999	Set the maximum radius that is judged to be OK.
Radius Min.	0 to 99,999.9999	Set the minimum radius that is judged to be OK.
Decentration X	-99,999.9999 to 99,999.9999	Decentration X is the difference between the X coordinate position of the reference setting and the X coordinate position of the calculated circle center. Set the range of decentration Xs that is judged to be OK.
Decentration Y	-99,999.9999 to 99,999.9999	Decentration Y is the difference between the Y coordinate position of the reference setting and the Y coordinate position of the calculated circle center. Set the range of decentration Ys that is judged to be OK.
Lost point count	0 to 3,600	Set the range for the number of lost points that is judged to be OK.

2-16-7 Output Parameters (Circular Scan Edge Position)

Specify how to treat the coordinates to be output to the external device as measurement results. This item can be changed if necessary. Normally, the factory default value will be used.



Precautions for Correct Use

After setting up the measurement parameters, changing the output parameters will cause measurement results to vary accordingly. If the output parameters have been changed, re-specify the measurement, too.

- 1 Click **Output parameter** in the Item tab area.
- 2 Specify each of the following items.

Setting item	Setting value [Factory default]	Description
Output coordinates	<ul style="list-style-type: none"> • [After scroll] • Before scroll 	As measurement results, select whether to output coordinate values to external devices before or after the position deflection correction is applied.
Calibration	<ul style="list-style-type: none"> • ON • [OFF] 	Select whether to reflect the calibration in the values output to the external device as measurement results. <ul style="list-style-type: none"> • ON: Output the coordinates converted into actual dimensions. • OFF: Output the camera coordinate values.
Reflect to overall judgment	<ul style="list-style-type: none"> • [ON] • OFF 	Enables choosing whether or not the judgement results of this processing unit is reflected in the scene overall judgment.



Additional Information

For output coordinates and calibration, refer to *Appendixes Measurement Mechanism Handling Coordinates* in the *Vision System FH/FHV Series User's Manual (Cat. No. Z365)*.

2-16-8 Key Points for Test Measurement and Adjustment (Circular Scan Edge Position)

In addition to the camera input image, the measured region, a graphic display of the measured results, and the edge position (the crosshair cursor) are also displayed as results in the Image Display area.

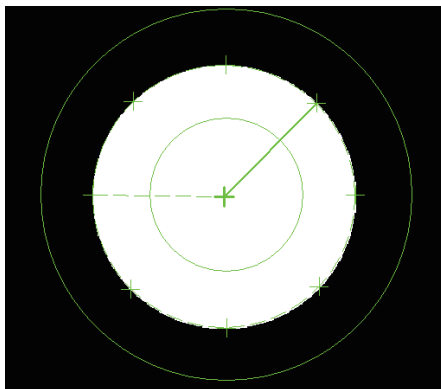

Edge position display (Sub image 0)

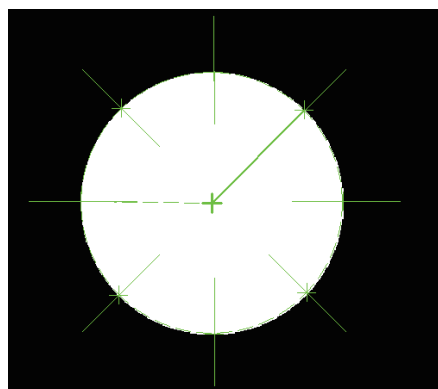

Display of edge position in each divided part (Sub image 1)

The following content is displayed in the *Detail result* area as text.

Displayed item	Description
Judge	Judgment results 0: No judgment (unmeasured) 1: Judgment result OK -1: Judgment result NG -10: Error (image format mismatch) -11: Error (unregistered model) -12: Error (insufficient memory) -20: Error (other errors)
Center coordinate X	The center X coordinate of the calculation result
Center coordinate Y	The center Y coordinate of the calculation result
Radius	The radius of the calculation result
Max. radius	The maximum radius of the calculation result

Displayed item	Description
Min. radius	The minimum radius of the calculation result
Decentration X	The decentration X of the calculation result
Decentration Y	The decentration Y of the calculation result
No. of lost points	No. of regions for which the detection of edges has failed

Key Points for Adjustment (Circular Scan Edge Position)

Adjust the setting parameters referring to the following points.

● When the measurement results are unstable

Parameter to be adjusted	Remedy
Measurement parameter	When the color of the edges to be detected is decided, specify the color with <i>Edge color</i> . If results are not stable even with the color specified, specify a larger value for the color variance range. If noise is detected as an edge, specify larger values for <i>Noise level</i> and <i>Noise width</i> .

2-16-9 Measurement Results for Which Output Is Possible (Circular Scan Edge Position)

The following values can be output using processing items related to result output. It is also possible to reference measurement values from calculation expressions and other processing units.

Measurement items	Character string	Description
Judge	JG	Judgment results 0: No judgment (unmeasured) 1: Judgment result OK -1: Judgment result NG -10: Error (image format mismatch) -11: Error (unregistered model) -12: Error (insufficient memory) -20: Error (other errors)
Center coordinate X	X	The center X coordinate of the calculation result
Center coordinate Y	Y	The center Y coordinate of the calculation result
Radius	R	The radius of the calculation result
Max. radius	MAXR	The maximum radius of the calculation result
Min. radius	MINR	The minimum radius of the calculation result
Decentration X	DEX	The decentration X of the calculation result
Decentration Y	DEY	The decentration Y of the calculation result
No. of lost points	LOST	No. of regions for which the detection of edges has failed
Ref. position X	SX	X coordinate of the reference coordinates
Ref. position Y	SY	Y coordinate of the reference coordinates
Maximum radius region number	MAXNO	The region number for the maximum radius
Minimum radius region number	MINNO	The region number for the minimum radius

2-16-10 External Reference Tables (Circular Scan Edge Position)

No.	Data name	Data ident	Set/Get	Data range
0	Judge	judge	Get only	0: No judgment (unmeasured), 1: Judgment result OK, -1: Judgment result NG, -10: Error (image format mismatch), -11: Error (unregistered model), -12: Error (insufficient memory), -20: Error (other errors)
5	Central X	centerX	Get only	-99,999.9999 to 99,999.9999
6	Central Y	centerY	Get only	-99,999.9999 to 99,999.9999
7	Radius	r	Get only	0 to 99,999.9999
8	Max. radius	r_max	Get only	0 to 99,999.9999
9	Min. radius	r_min	Get only	0 to 99,999.9999
10	Deviation X	decentrationX	Get only	-99,999.9999 to 99,999.9999
11	Deviation Y	decentrationY	Get only	-99,999.9999 to 99,999.9999
12	Lost point	void_count	Get only	0 to 3,600
13	Reference X	standardX	Get only	0 to 99,999.9999
14	Reference Y	standardY	Get only	0 to 99,999.9999
15	Max. radius region No.	max_no	Get only	0 to 3,599
16	Min. radius region No.	min_no	Get only	0 to 3,599
17	Approx. radius	r_apx	Get only	0 to 99,999.9999
101	Output Coordinates	outputCoordinate	Set/Get	0: After scroll, 1: Before scroll
102	Calibration	calibration	Set/Get	0: OFF, 1: ON
103	Reflect to overall judgement	overallJudge	Set/Get	0: ON, 1: OFF
120	Start angle	start_angle	Set/Get	0 to 359
121	Division method	div_type	Set/Get	0: Divide number 1: Angle number
122	No. of region divisions	scan_num	Set/Get	3 to 3,600
123	Skipping angle	notch_angle	Set/Get	0.01 to 179.999
124	Mask size	region_w	Set/Get	0 to 1,000
125	Display region	displayRegion	Set/Get	0 to 3,599
126	Direction	direction	Set/Get	0 to 1
127	Fix region count	separateType	Set/Get	0: Not fixed, 1: Fixed
138	Compatibility mode (Ver.5.73 or earlier)	compMode	Set/Get	0: OFF, 1: ON
139	Distance	inlierDist	Set/Get	0 to 10,000
140	Disabled region	notch_ignor	Set/Get	0 to 3,600
141	Reference X	referencePosX	Set/Get	0 to 99,999.9999
142	Reference Y	referencePosY	Set/Get	0 to 99,999.9999
143	Method	circle_type	Set/Get	0: Approximation circle, 1: Smallest enclosing circle
144	Method	calc_type	Set/Get	0: Fast, 1: Fine

No.	Data name	Data ident	Set/Get	Data range
145	Upper limit of center X	upperCenterx	Set/Get	-99,999.9999 to 99,999.9999
146	Lower limit of center X	lowerCenterx	Set/Get	-99,999.9999 to 99,999.9999
147	Upper limit of center Y	upperCentery	Set/Get	-99,999.9999 to 99,999.9999
148	Lower limit of center Y	lowerCentery	Set/Get	-99,999.9999 to 99,999.9999
149	Upper limit of radius	upperRadius	Set/Get	0 to 99,999.9999
150	Lower limit of radius	lowerRadius	Set/Get	0 to 99,999.9999
151	Upper limit of Max. radius	upperMaxRadius	Set/Get	0 to 99,999.9999
152	Lower limit of Max. radius	lowerMaxRadius	Set/Get	0 to 99,999.9999
153	Upper limit of Min. radius	upperMinRadius	Set/Get	0 to 99,999.9999
154	Lower limit of Min. radius	lowerMinRadius	Set/Get	0 to 99,999.9999
155	Upper limit of deviation X	upperDecentrationX	Set/Get	-99,999.9999 to 99,999.9999
156	Lower limit of deviation X	lowerDecentrationX	Set/Get	-99,999.9999 to 99,999.9999
157	Upper limit of deviation Y	upperDecentrationY	Set/Get	-99,999.9999 to 99,999.9999
158	Lower limit of deviation Y	lowerDecentrationY	Set/Get	-99,999.9999 to 99,999.9999
159	Upper limit of the lostwidth	upperLostPoint	Set/Get	0 to 3,600
160	Lower limit of the lostwidth	lowerLostPoint	Set/Get	0 to 3,600
200	Edge color specification	colorSpecification	Set/Get	0: OFF 1: ON
201	Edge color R	colorR	Set/Get	0 to 255
202	Edge color G	colorG	Set/Get	0 to 255
203	Edge color B	colorB	Set/Get	0 to 255
204	Difference R	colorDevR	Set/Get	0 to 127
205	Difference G	colorDevG	Set/Get	0 to 127
206	Difference B	colorDevB	Set/Get	0 to 127
207	Edge detection mode	detectionMode	Set/Get	0: Color IN, 1: Color OUT
208	Edge No.	edgeNo	Set/Get	0 to 99
209	Edge Level Lower limit	edgeLevel	Set/Get	0 to 100
210	Noise level	noiseLevel	Set/Get	Color camera: 0 to 442 Monochrome camera: 0 to 255
211	Noise width	noiseWidth	Set/Get	0 to 9,999
212	Edge color level	colorLevel	Set/Get	0 to 442
213	Monochrome edge detection mode	monoDetectMode	Set/Get	0: Light → Dark, 1: Dark → Light

No.	Data name	Data ident	Set/Get	Data range
214	Edge level Lower limit absolute value	edgeLevelAbs	Set/Get	Color camera: 0 to 442 Monochrome camera: 0 to 255
215	Edge level specification method	edgeLevelKind	Set/Get	0: %, 1: Absolute value
216	Measure type	measureType	Set/Get	0: Projection, 1: Derivation
217	Monochrome Derivation edge detection mode	diffDetectMode	Set/Get	0: Absolute 1: Dark → Light 2: Light → Dark
218	Edge Level Upper limit	edgeLevelUpper	Set/Get	0 to 100
219	Edge level Upper limit absolute value	edgeLevelUpperAbs	Set/Get	Color camera: 0 to 442 Monochrome camera: 0 to 255
220	Filter Strength	filterStrength	Set/Get	0 to 100
221	Setting unit of reference coordinate	refUnitNo	Set/Get	-1 to 9,999
222	Setting type of reference coordinate	refSettingType	Set/Get	0:Numerical 1:Unit
223	Use point coordinate before scroll	beforeScrollRefMode	Set/Get	0: Not use, 1: Use
224	Reference X before scroll	beforeScrollRefPosX	Set/Get	-99,999.9999 to 99,999.9999
225	Reference Y before scroll	beforeScrollRefPosY	Set/Get	-99,999.9999 to 99,999.9999
6,002	Format	cameraColor	Set/Get	1: Monochrome camera 2: Color camera
10,100+N (N=0 to 3,599)	Enable/disable region	area_enabled0000 to area_enabled3599	Set/Get	0 to 1
30,000+N (N=0 to 3,599)	Edge Position(X)	edgePosX0000 to edgePosX3599	Get only	-99,999.9999 to 99,999.9999
40,000+N (N=0 to 3,599)	Edge Position(Y)	edgePosY0000 to edgePosY3599	Get only	-99,999.9999 to 99,999.9999
90,000	figure0 Count	figArea0_count	Set/Get	0 to 1
90,001	figure0 Type	figArea0_fig0_type	Set/Get	64: Circumference 256: Wide arc
90,002	figure0 mode	figArea0_fig0_mode	Set/Get	0: OR
90,025	figure0 Circumference Center Position X	figArea0_fig0_circleW_X	Set/Get	-99,999 to 99,999
90,026	figure0 Circumference Center Position Y	figArea0_fig0_circleW_Y	Set/Get	-99,999 to 99,999
90,027	figure0 Circumference Radius	figArea0_fig0_circleW_R	Set/Get	0 to 99,999
90,028	figure0 Circumference Width	figArea0_fig0_circleW_W	Set/Get	0 to 99,999
90,034	figure0 Wide arc Center Position X	figArea0_fig0_arcW_X	Set/Get	-99,999 to 99,999
90,035	figure0 Wide arc Center Position Y	figArea0_fig0_arcW_Y	Set/Get	-99,999 to 99,999

No.	Data name	Data ident	Set/Get	Data range
90,036	figure0 Wide arc Radius	figAr- ea0_fig0_arcW_R	Set/Get	0 to 99,999
90,037	figure0 Wide arc Start angle	figAr- ea0_fig0_arcW_SA	Set/Get	-180 to 180
90,038	figure0 Wide arc End angle	figAr- ea0_fig0_arcW_EA	Set/Get	-180 to 180
90,039	figure0 Wide arc Width	figAr- ea0_fig0_arcW_W	Set/Get	0 to 99,999
90,099	figure0 Update	figArea0_update	Set only	1: Update

2-17 Circular Scan Edge Width

This processing item detects the width of the measurement object by using the change in color within the measurement region.

Used in the Following Case

When getting multiple widths of a circular object:

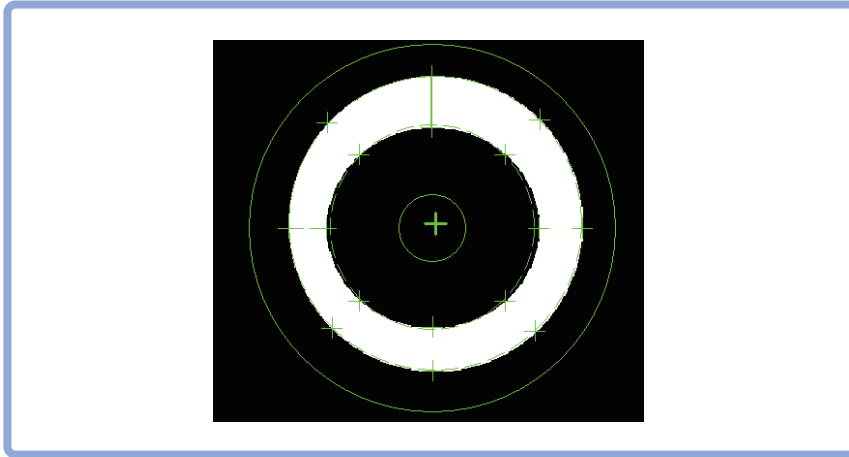

Precautions for Correct Use

Processing is different for color images and monochrome images. When the camera type used in the previous setup was changed to color or monochrome type, perform the settings again.



Additional Information

Edge processing basic concepts:

For details, refer to *Appendixes Measurement Mechanism Edge Detection Measurement* in the *Vision System FH/FHV Series User's Manual (Cat. No. Z365)*.

2-17-1 Settings Flow (Circular Scan Edge Width)

To set Circular Scan Edge Width, follow the steps below.

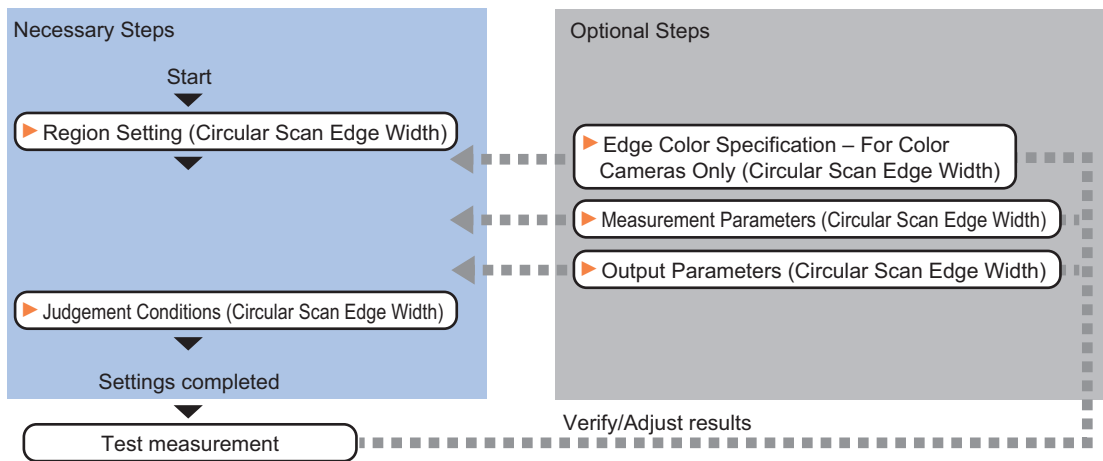

List of Circular Scan Edge Width Items

Item	Description
Region setting	Sets the measurement area. <i>2-17-2 Region Setting (Circular Scan Edge Width) on page 2-251</i>
Edge color (for color cameras only)	This item selects the color of the edges to be detected. If the target color changes, this setting is not necessary. If the color is not specified, positions in the measurement region where the color changes drastically are detected as an edge. <i>2-17-3 Edge Color Specification - For Color Cameras Only (Circular Scan Edge Width) on page 2-253</i>
Measurement parameter	Measurement parameter can be changed as needed to address unstable measurement results. The displayed items depend on whether your camera is a color or monochrome camera. Normally, the factory default value will be used. <i>2-17-4 Measurement Parameters (Circular Scan Edge Width) on page 2-254</i>
Judgment condition	Sets processing conditions for measurement and judgment conditions for measurement results. <i>2-17-5 Judgement Conditions (Circular Scan Edge Width) on page 2-257</i>
Output parameter	This item can be changed as necessary. Normally, the factory default value will be used. Use the output parameter to specify how to handle the coordinates. <i>2-17-6 Output Parameters (Circular Scan Edge Width) on page 2-258</i>

2-17-2 Region Setting (Circular Scan Edge Width)

This item is used to set up the measurement area.

Specify the measurement region of **Circular Scan Edge Width** by using circular shapes.

- 1** In the Item tab area, click **Region setting**.
- 2** Use the Drawing tools to specify the measurement region.
To align with the measurement area and change the number of measurement points, uncheck this.

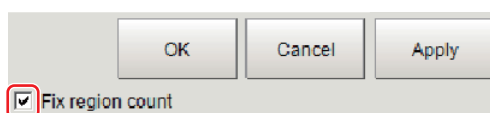

- 3** Click **OK** in the *Figure setting* area.
- **OK**: Changes the settings and returns to the previous menu.
 - **Cancel**: Changes are discarded. Returns to the previous menu.
 - **Apply**: Updates the settings without leaving edit window.
- 4** In the *Region* area, specify a value for each item.

The screenshot shows the 'Region' settings dialog box. It contains the following elements:

- Width measure type**: A dropdown menu currently set to 'Circumference'.
- Direction**: Two radio buttons, 'In→Out' (selected) and 'Out→In'.
- Scan sub-region**: A section with three options:
 - Divide number**: A radio button (selected) and a numeric input field with the value '4'.
 - Angle number**: A radio button (unselected) and a numeric input field with the value '90.000'.
 - Start angle**: A radio button (unselected) and a numeric input field with the value '0'.

Setting item	Setting value [Factory default]	Description
Width measure type	<ul style="list-style-type: none"> • [Circumference] • Diameter 	Select the measurement target for the workpiece.
Direction	<ul style="list-style-type: none"> • [Out → In] • In → Out 	Set the measurement direction when <i>Diameter</i> is selected.
Scan sub-region	<ul style="list-style-type: none"> • [Divide number] • Angle number 	Set the measurement point. Use either the <i>Divide number</i> or the <i>Angle number</i> for this setting.
Divide number	3 to 3,600 [4]	Set the number of divisions for the circle. The specified value is used as the measurement point.
Angle number	When the width measure type is circumference: 1.000 to 179.999 When the width measure type is diameter: 1.000 to 90.000 [90.000]	Set the skipping angle for the circle. The measurement point is determined based on the specified angle.
Start angle	0 to 359 [0]	Set the start angle to specify a region.



Precautions for Correct Use

When the width measurement target is set to *Diameter* and the number of divisions and the skipping angle are set to an odd number value, 1 will be added to these settings so that they become even numbers.

The region is divided by the specified number of points.

- Explanations of the display:
 - Green solid line: Represents the circular region.
 - Rectangle: Represents the sub-region.
 - Pink solid line: Represents the angle and the measurement direction (arrow) to specify the region.

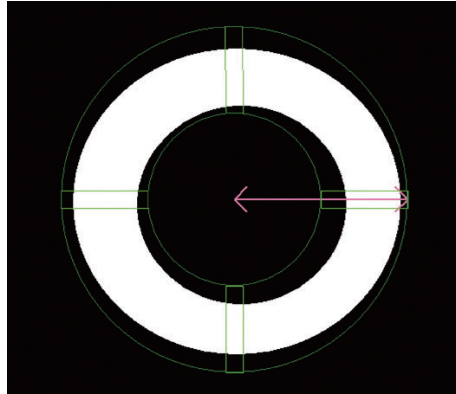

- 5** Specify the filtering settings as necessary.

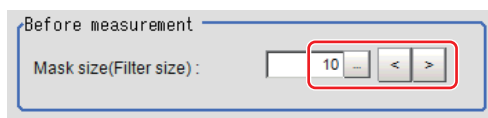

Setting item	Setting value [Factory default]	Description
Mask size	0 to 1,000 [10]	Set the filter size when smoothing the measurement point vicinity. When 5 is set, smoothing is processed for a total of 11 points: the measurement point and the 5 pixels before and after it.

- 6** Perform the display setting if required.
Placing a check at *Filtered image* makes it easier to change the filtering setting.

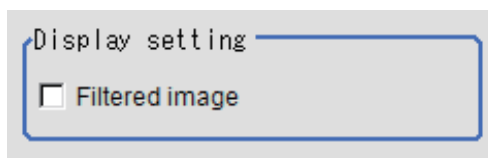

Setting item	Setting value [Factory default]	Description
Filtered image	<ul style="list-style-type: none"> • Checked • [Unchecked] 	If checked, the filtered image of the ranges set with the <i>Scan sub-region</i> and <i>Mask size</i> after smoothing is displayed.

2-17-3 Edge Color Specification - For Color Cameras Only (Circular Scan Edge Width)

This item selects the color of the edges to be detected.

If the target color changes, this setting is not necessary. If the color is not specified, positions in the measurement region where the color changes drastically are detected as an edge.

- 1** In the Item tab area, click **Edge color**.
- 2** Place a check at *Edge color specification* in the *Color setting* area.

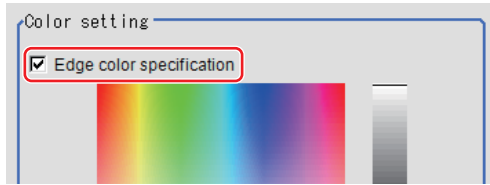

3 Select the color to detect as edges.

Setting item	Setting value [Factory default]	Description
Image Display area	-	Specify a region on the image that includes the target color. The average color of the specified region is registered.
Color chart	-	Click the reference color on the color chart to specify it. The RGB values for the specified color are displayed at the bottom.
R, G, B	0 to 255 [255]	The color to be detected is set with the RGB values.
Difference R, G, B	0 to 127 [5]	This sets the allowable color difference for detecting the edge, using the specified color as the reference. The larger the difference values, the larger the color range that is used to detect the edge.
Detection mode	<ul style="list-style-type: none"> [Color IN] Color OUT 	<ul style="list-style-type: none"> Color IN: The position where a color other than the specified color changes to the specified color is detected as the edge. Color OUT: The position where the specified color changes to a color other than the specified color is detected as the edge. <div style="display: flex; justify-content: space-around; align-items: flex-start;"> <div style="text-align: center;"> <p>For "Color IN" edge measurement mode</p> </div> <div style="text-align: center;"> <p>For "Color OUT" edge measurement mode</p> </div> </div> <div style="display: flex; justify-content: space-around; align-items: flex-start; margin-top: 20px;"> <div style="text-align: center;"> <p>For "Color IN" edge measurement mode</p> </div> <div style="text-align: center;"> <p>For "Color OUT" edge measurement mode</p> </div> </div>

2-17-4 Measurement Parameters (Circular Scan Edge Width)

Measurement parameters can be changed as needed to address unstable measurement results. Normally, the factory default value will be used.

After changing a setting, check whether measurement can be done properly by performing an actual measurement.

- 1** In the Item tab area, click **Measurement**.
The edge profile of the measurement region is displayed as a graph in the *Image Display* area.
- 2** In the **Display position** area, specify a value for each item.

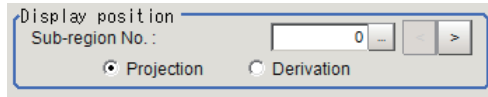

Setting item	Setting value [Factory default]	Description
Sub-region No.	0 to 3,599 [0]	Specify the <i>Sub-region No.</i> for which the edge profile is displayed.
Projection Derivation	<ul style="list-style-type: none"> [Projection] Derivation 	<ul style="list-style-type: none"> Projection: The edge is searched from the center toward the outside direction. Derivation: The edge is searched from the outside of the circle toward the center.

3 If necessary, specify a value for each item in the *Measurement condition* area.

- For color cameras:

Edge Color Not Specified

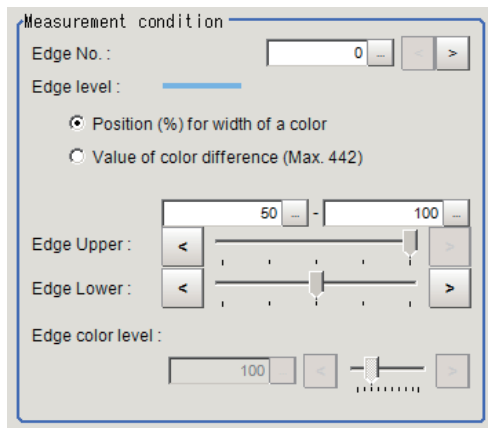

Edge Color Specified

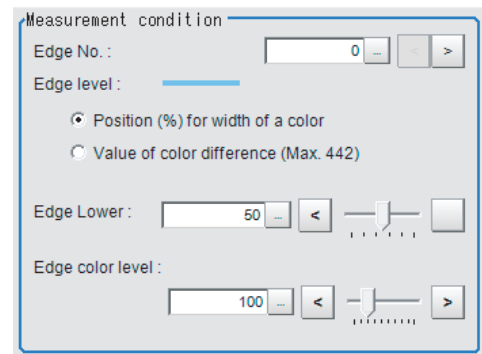

Setting item	Setting value [Factory default]	Description
Edge No.	0 to 99 [0]	Specify the edge number used to extract edges. <i>Edge numbers</i> are assigned to detected edges starting from 0 and going on in the direction from the start point (the arrow point) to the end point (the direction of arrow) in the selected area.
Edge Upper (only when edge color is not specified) Edge Lower	<ul style="list-style-type: none"> Position (%) for width of a color 0 to 100 [50] to [100] Value of color 0 to 442 [20] to [442] 	Set a range of a color difference level with which the edge is detected. For details, refer to <i>Appendixes Measurement Mechanism Edge Detection Measurement</i> in the <i>Vision System FH/FHV Series User's Manual (Cat. No. Z365)</i> .
Edge color level	0 to 442 [100]	This emphasis level can be specified only if the edge color to detect is specified.

- For monochrome cameras:

When the *Measurement type* is *Projection*:

When the *Measurement type* is *Derivation*:

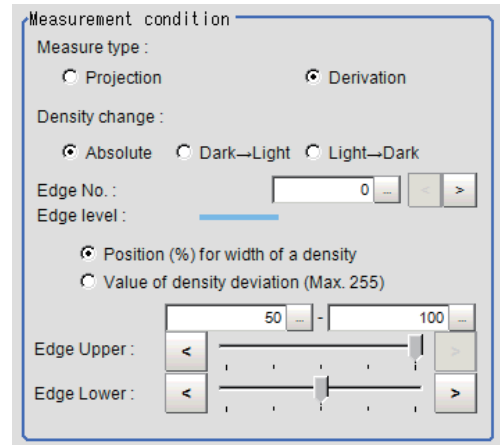
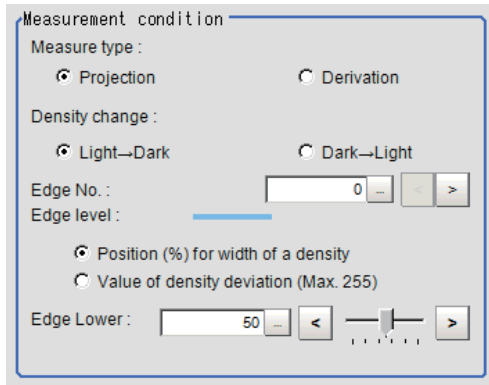

Setting item	Setting value [Factory default]	Description
Measure type	<ul style="list-style-type: none"> [Projection] Derivation 	<p>As the <i>Measurement type</i>, specify either <i>Projection</i> or <i>Derivation</i>.</p> <p>For details, refer to <i>Appendixes Measurement Mechanism Edge Detection Measurement</i> in the <i>Vision System FH/FHV Series User's Manual (Cat. No. Z365)</i>.</p>
Density change	<ul style="list-style-type: none"> Absolute (only when the <i>Measure type</i> is <i>Derivation</i>) [Dark → Light] Light → Dark 	<p>Select whether a black-to-white change or a white-to-black change should be recognized as a density change in the specified region.</p>
Edge No.	0 to 99 [0]	<p>Specify the edge number used to extract edges.</p> <p><i>Edge numbers</i> are assigned to detected edges starting from 0 and going on in the direction from the start point (the arrow point) to the end point (the direction of arrow) in the selected area.</p>
Edge Upper Edge Lower	<ul style="list-style-type: none"> Position (%) for width of a density 0 to 100 [50] to [100] Value of density 0 to 255 [20] to [255] 	<p>Select the density change level to be detected as edges.</p> <p>The upper limit of edges can be set only when the <i>Measure type</i> is <i>Derivation</i>.</p> <p>For details, refer to <i>Appendixes Measurement Mechanism Edge Detection Measurement</i> in the <i>Vision System FH/FHV Series User's Manual (Cat. No. Z365)</i>.</p>

4 If necessary, set each item in the *Noise removal* area.

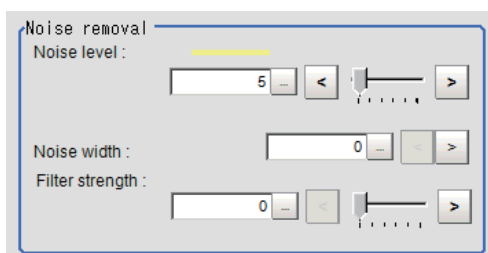

Setting item	Setting value [Factory default]	Description
Noise level	<ul style="list-style-type: none"> For color cameras: 0 to 442 [5] For mono-chrome cameras: 0 to 255 [5] 	When edges are incorrectly detected due to noise, increase this value. For details, refer to <i>Appendixes Measurement Mechanism Edge Detection Measurement</i> in the <i>Vision System FH/FHV Series User's Manual (Cat. No. Z365)</i> .
Noise width	0 to 9,999 [0]	Set the width for judging noise. When detection is affected by noise, increase this value. For details, refer to <i>Appendixes Measurement Mechanism Edge Detection Measurement</i> in the <i>Vision System FH/FHV Series User's Manual (Cat. No. Z365)</i> .
Filter strength	0 to 100 [0]	If a valley appears in the histogram around the edge threshold value due to noises, smoothen the edge profile using a filter to prevent wrong error detection from being detected. Strengthening the filter smoothen the edge profile further.

5 In the Sub-region detail area, set enable or disable measurement as required.

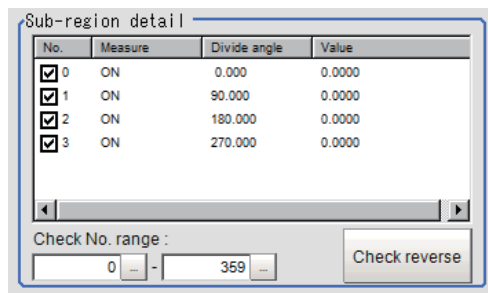

Setting item	Setting value [Factory default]	Description
Check No. range	0 to 3,599 [0] to [3,599]	Specify the edge measurement number for which to perform batch reversing of the enable or disable measurement setting. Click Check reverse to reverse the check box settings of the edge measurement number within the range.

2-17-5 Judgement Conditions (Circular Scan Edge Width)

Specify the range to be judged as OK.

1 In the Item Tab area click **Judgement**.

2 Set up the judgment condition.



Additional Information

The values beside each item are measurement results of the displayed image. Take these values into consideration to determine the upper and lower limit values.

Setting item	Setting value	Description
Edge width Max.	0 to 99,999.9999	Specify the upper and lower limits of the maximum width judged to be OK.
Edge width Min.	0 to 99,999.9999	Specify the upper and lower limits of the minimum width judged to be OK.
Edge width Ave.	0 to 99,999.9999	Specify the upper and lower limits of the average width judged to be OK.
Lost width count	0 to 3,600	Specify the upper and lower limits of the lost width count judged to be OK.

2-17-6 Output Parameters (Circular Scan Edge Width)

Specify how to treat the coordinates to be output to the external device as measurement results. This item can be changed if necessary. Normally, the factory default value will be used.



Precautions for Correct Use

After setting up the measurement parameters, changing the output parameters will cause measurement results to vary accordingly. If the output parameters have been changed, re-specify the measurement, too.

- 1 Click **Output parameter** in the Item Tab area.
- 2 Specify each of the following items.

Setting item	Setting value [Factory default]	Description
Calibration	<ul style="list-style-type: none"> • ON • [OFF] 	Select whether to reflect the calibration in the values output to the external device as measurement results. <ul style="list-style-type: none"> • ON: Output the coordinates converted into actual dimensions. • OFF: Output the camera coordinate values.
Reflect to overall judgment	<ul style="list-style-type: none"> • [ON] • OFF 	Enables choosing whether or not the judgement results of this processing unit is reflected in the scene overall judgment.

2-17-7 Key Points for Test Measurement and Adjustment (Circular Scan Edge Width)

The following content is displayed in the *Detail result* area as text.

Displayed item	Description
Judge	Judgment results 0: No judgment (unmeasured) 1: Judgment result OK -1: Judgment result NG -10: Error (image format mismatch) -11: Error (unregistered model) -12: Error (insufficient memory) -20: Error (other errors)
Edge width Max.	The maximum value of edge width

Displayed item	Description
Edge width Min.	The minimum value of edge width
Edge width Ave.	The average value of all the edge width
Lost width count	The number of the scanned areas for which the detection of width failed

The image specified in the Sub-image number in the image display setting is displayed in the *Image Display* area.

Sub-image number	Description of image to be displayed
0	Measurement image
1	Scan region

Key Points for Adjustment (Circular Scan Edge Width)

Adjust the setting parameters referring to the following points.

● When the measurement results are unstable

Parameter to be adjusted	Remedy
Measurement parameter	When the color of the edges to be detected is decided, specify the color with <i>Edge color</i> . If results are not stable even with the color specified, specify a larger value for the color variance range. If noise is detected as an edge, specify larger values for <i>Noise level</i> and <i>Noise width</i> .

2-17-8 Measurement Results for Which Output Is Possible (Circular Scan Edge Width)

The following values can be output using processing items related to result output. It is also possible to reference measurement values from calculation expressions and other processing units.

Measurement items	Character string	Description
Judge	JG	Judgment results 0: No judgment (unmeasured) 1: Judgment result OK -1: Judgment result NG -10: Error (image format mismatch) -11: Error (unregistered model) -12: Error (insufficient memory) -20: Error (other errors)
Edge width Max.	MAXW	The maximum value of edge width
Edge width Min.	MINW	The minimum value of edge width
Edge width Ave.	AVEW	The average value of all the edge width
Lost width count	LOST	The number of the scanned areas for which the detection of width failed
Edge width Max. region No.	MAXNO	Region number of the maximum edge width
Edge width Min. region No.	MINNO	Region number of the minimum edge width



Precautions for Correct Use

Note that if X and Y magnifications are not the same in the camera calibration, the edge width will not be measured correctly.

2-17-9 External Reference Tables (Circular Scan Edge Width)

No.	Data name	Data ident	Set/Get	Data range
0	Judge	judge	Get only	0: No judgment (unmeasured), 1: Judgment result OK, -1: Judgment result NG, -10: Error (image format mismatch), -11: Error (unregistered model), -12: Error (insufficient memory), -20: Error (other errors)
5	Edge width Max.	width_max	Get only	0 to 99,999.9999
6	Edge width Min.	width_min	Get only	0 to 99,999.9999
7	Edge width Ave.	width_ave	Get only	0 to 99,999.9999
10	Lost width count	void_count	Get only	0 to 3,600
11	Max. edge width region No.	max_no	Get only	0 to 3,599
12	Min. edge width region No.	min_no	Get only	0 to 3,599
101	Output Coordinates	outputCoordinate	Set/Get	0: After scroll 1: Before scroll
102	Calibration	calibration	Set/Get	0: OFF, 1: ON
103	Reflect to overall judgement	overallJudge	Set/Get	0: ON, 1: OFF
120	Start angle	start_angle	Set/Get	0 to 359
121	Division method	div_type	Set/Get	0: Divide number 1: Angle number
122	No. of region divisions	scan_num	Set/Get	3 to 3,600
123	Skipping angle	notch_angle	Set/Get	0.01 to 179.999
124	Mask size	region_w	Set/Get	0 to 1,000
125	Display region	displayRegion	Set/Get	0 to 3,599
126	Direction	direction	Set/Get	0: In → Out, 1: Out → In
127	Fix region count	separateType	Set/Get	0: Not fixed, 1: Fixed
140	Width measure	kind	Set/Get	0: Edge width, 1: Diameter
141	Display direction	displayDirection	Set/Get	0: Forward, 1: Reverse
142	Upper limit of Max. edge width	upper_max_width	Set/Get	0 to 99,999.9999
143	Lower limit of Max. edge width	lower_max_width	Set/Get	0 to 99,999.9999
144	Upper limit of Min. edge width	upper_min_width	Set/Get	0 to 99,999.9999
145	Lower limit of Min. edge width	lower_min_width	Set/Get	0 to 99,999.9999
146	Upper limit of Avg. edge width	upper_ave_width	Set/Get	0 to 99,999.9999

No.	Data name	Data ident	Set/Get	Data range
147	Lower limit of Avg. edge width	lower_ave_width	Set/Get	0 to 99,999.9999
148	Upper limit of the lostwidth	upperLostPoint	Set/Get	0 to 3,600
149	Lower limit of the lostwidth	lowerLostPoint	Set/Get	0 to 3,600
201	Edge color R	colorR	Set/Get	0 to 255
202	Edge color G	colorG	Set/Get	0 to 255
203	Edge color B	colorB	Set/Get	0 to 255
204	Difference R	colorDevR	Set/Get	0 to 127
205	Difference G	colorDevG	Set/Get	0 to 127
206	Difference B	colorDevB	Set/Get	0 to 127
207	Edge detection mode	detectionMode	Set/Get	0: Color IN, 1: Color OUT
208	Edge No.	edgeNo	Set/Get	0 to 99
209	Edge Level Lower limit	edgeLevel	Set/Get	0 to 100
210	Noise level	noiseLevel	Set/Get	Color camera: 0 to 442 Monochrome camera: 0 to 255
211	Noise width	noiseWidth	Set/Get	0 to 9,999
212	Edge color level	colorLevel	Set/Get	0 to 442
213	Monochrome edge detection mode	monoDetectMode	Set/Get	0: Light → Dark, 1: Dark → Light
214	Edge level Lower limit absolute value	edgeLevelAbs	Set/Get	Color camera: 0 to 442 Monochrome camera: 0 to 255
215	Edge level specification method	edgeLevelKind	Set/Get	0: %, 1: Absolute value
216	Measure type	measureType	Set/Get	0: Projection, 1: Derivation
217	Monochrome Derivation edge detection mode	diffDetectMode	Set/Get	0: Absolute, 1: Dark → Light, 2: Light → Dark
218	Edge Level Upper limit	edgeLevelUpper	Set/Get	0 to 100
219	Edge level Upper limit absolute value	edgeLevelUpperAbs	Set/Get	Color camera: 0 to 442 Monochrome camera: 0 to 255
220	Filter Strength	filterStrength	Set/Get	0 to 100
6,002	Format	cameraColor	Set/Get	1: Monochrome camera 2: Color camera
10,100+N (N=0 to 3,599)	Enable/disable region	area_enabled0000 to area_enabled3599	Set/Get	0 to 1
30,000+N (N=0 to 3,599)	Start Edge Position(X)	SedgePosX0000 to SedgePosX3599	Get only	-99,999.9999 to 99,999.9999
40,000+N (N=0 to 3,599)	Start Edge Position(Y)	SedgePosY0000 to SedgePosY3599	Get only	-99,999.9999 to 99,999.9999
50,000+N (N=0 to 3,599)	End Edge Position(X)	EedgePosX0000 to EedgePosX3599	Get only	-99,999.9999 to 99,999.9999
60,000+N (N=0 to 3,599)	End Edge Position(Y)	EedgePosY0000 to EedgePosY3599	Get only	-99,999.9999 to 99,999.9999

No.	Data name	Data ident	Set/Get	Data range
90,000	figure0 Count	figArea0_count	Set/Get	0 to 1
90,001	figure0 Type	figArea0_fig0_type	Set/Get	64: Circumference
90,002	figure0 mode	figArea0_fig0_mode	Set/Get	0: OR
90,025	figure0 Circumference Center Position X	figArea0_fig0_circleW_X	Set/Get	-99,999 to 99,999
90,026	figure0 Circumference Center Position Y	figArea0_fig0_circleW_Y	Set/Get	-99,999 to 99,999
90,027	figure0 Circumference Radius	figArea0_fig0_circleW_R	Set/Get	0 to 99,999
90,028	figure0 Circumference Width	figArea0_fig0_circleW_W	Set/Get	0 to 99,999
90,099	figure0 Update	figArea0_update	Set only	1: Update

2-18 Intersection

This processing item measures a corner position (corner) of a work.

Calculate approximate lines from the edge information on two sides of a square work to measure the angle formed at the intersection of the two lines.

Used in the Following Case

When you want to align the work position based on the feature of its corner:

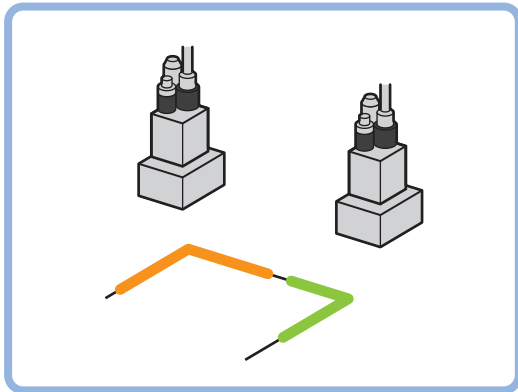

Precautions for Correct Use

Processing is different for color images and monochrome images. When the camera type used in the previous setup was changed to color or monochrome type, perform the settings again.

2-18-1 Settings Flow (Intersection)

To set Intersection, follow the steps below.

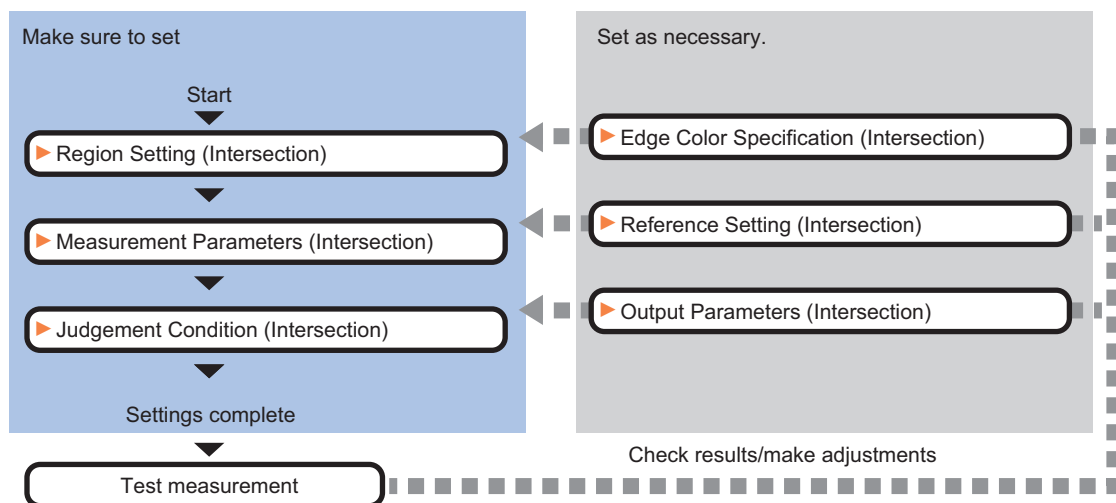

List of Intersection Items

Item	Description
Region setting	This item sets the scan edge area (wide line) for each the two sides to be measured. <i>2-18-2 Region Setting (Intersection) on page 2-264</i>
Edge color (for color cameras only)	This item selects the color of the edges to be detected. If the target color changes, this setting is not necessary. If the color is not specified, positions in the measurement region where the color changes drastically are detected as an edge. <i>2-18-3 Edge Color Specification - For Color Cameras Only (Intersection) on page 2-265</i>
Ref. setting	This item can be changed as necessary. Specify the reference position within the camera's field of view. <i>2-18-4 Reference Setting (Intersection) on page 2-266</i>
Measurement parameter	This item sets the parameters relating to edge measurement and Line Regression calculation to measure the intersection coordinates. <i>2-18-5 Measurement Parameters (Intersection) on page 2-268</i>
Judgment condition	Sets processing conditions for measurement and judgment conditions for measurement results. <i>2-18-6 Judgement Condition (Intersection) on page 2-272</i>
Output parameter	This item can be changed as necessary. Normally, the factory default value will be used. Use the output parameter to specify how to handle the coordinates. <i>2-18-7 Output Parameters (Intersection) on page 2-272</i>

2-18-2 Region Setting (Intersection)

This item is used to set up the measurement area.

Specify the measurement region for **Intersection** by using wide lines.

- 1 In the Item tab area, click **Region setting**.
- 2 Select the figure to be set.

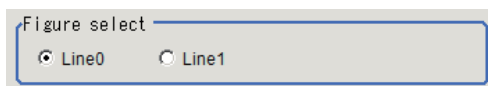

- 3 Use the Drawing tools to specify the measurement region.
To align with the measurement area and change the number of measurement points, uncheck this.

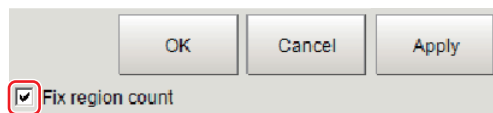

- 4 Click **OK** in the *Figure setting* area.
 - **OK**: Changes the settings and returns to the previous menu.
 - **Cancel**: Changes are discarded. Returns to the previous menu.
 - **Apply**: Updates the settings without leaving edit window.

5 Set the measurement point and the filter size for the region.

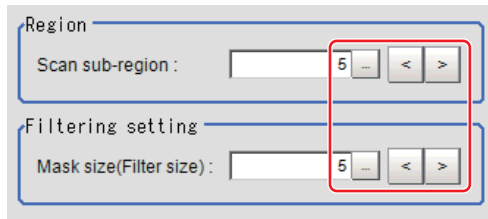

Setting item	Setting value [Factory default]	Description
Scan sub-region	1 to 4,000 [5]	Set the measurement point for the region.
Mask size	0 to 200 [5]	Set the filter size when smoothing the measurement point vicinity. When 5 is set, smoothing is processed for a total of 11 points: the measurement point and the 5 pixels before and after it.

6 The region is divided equally.

Division of Scan Area

The scan region, when the number of measurement points is 1

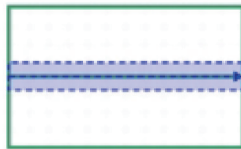

The scan region, when the number of measurement points is 2

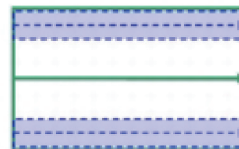

The scan region, when the number of measurement points is 3

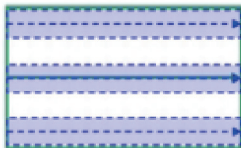

The scan region, when the number of measurement points is 4

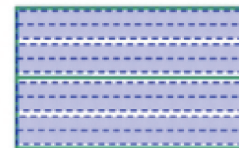

7 Repeat steps 2 to 6, and set the region of line 1.



Additional Information

You can specify enable/disable for each edge measurement number. Clicking edge measurement points displays the following screen.

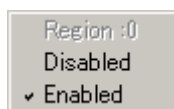

2-18-3 Edge Color Specification - For Color Cameras Only (Intersection)

This item selects the color of the edges to be detected.

If the target color changes, this setting is not necessary. If the color is not specified, positions in the measurement region where the color changes drastically are detected as an edge.

- 1 In the Item tab area, click **Edge color**.
- 2 Place a check at *Edge color specification* in the *Color setting* area.

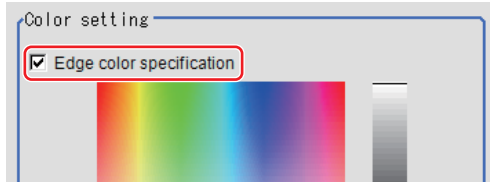

- 3 Select the color to detect as edges.

Setting item	Setting value [Factory default]	Description
Image Display area	-	Specify a region on the image that includes the target color. The average color of the specified region is registered.
Color chart	-	Click the reference color on the color chart to specify it. The RGB values for the specified color are displayed at the bottom.
R, G, B	0 to 255 [255]	The color to be detected is set with the RGB values.
Difference R, G, B	0 to 127 [5]	This sets the allowable color difference for detecting the edge, using the specified color as the reference. The larger the difference values, the larger the color range that is used to detect the edge.
Detection mode	<ul style="list-style-type: none"> • [Color IN] • Color OUT 	<ul style="list-style-type: none"> • Color IN: The position where a color other than the specified color changes to the specified color is detected as the edge. • Color OUT: The position where the specified color changes to a color other than the specified color is detected as the edge. <div style="display: flex; justify-content: space-around; align-items: flex-start;"> <div style="text-align: center;"> <p>For "Color IN" edge measurement mode</p> </div> <div style="text-align: center;"> <p>For "Color OUT" edge measurement mode</p> </div> </div> <div style="display: flex; justify-content: space-around; align-items: flex-start; margin-top: 20px;"> <div style="text-align: center;"> <p>For "Color IN" edge measurement mode</p> </div> <div style="text-align: center;"> <p>For "Color OUT" edge measurement mode</p> </div> </div>

2-18-4 Reference Setting (Intersection)

When the model is set, this position is automatically set at the same time as the reference position. This item can be set to change the reference position to any desired position. This is handy for measuring the position deviation from a certain position.

A reference position can be set either directly or by referencing a unit.

Specifying directly

Click a position on the image you want to use as a reference position, or input coordinate data for that point.

- 1 In the **Item** tab area, click **Ref. setting**.
In the *Display* area, the current reference position will be displayed as the crosshair cursor.

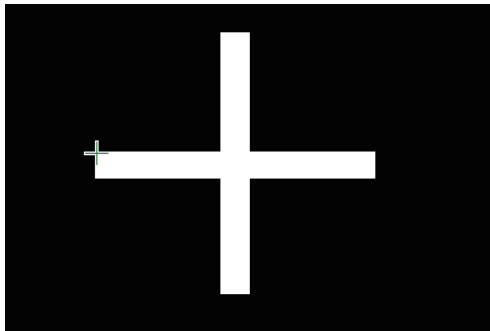

- 2 In the *Method* area, select *Numerical*.



- 3 Click the position to be set as the reference.



Additional Information

Displaying the image enlarged makes this clicking easier.

For details, refer to *Appendixes Basic Knowledge about Operations Using the Zoom Function in the Vision System FH/FHV Series User's Manual* (Cat. No. Z365).

- 4 Make fine adjustments using numeric value inputs or the arrow buttons as required.

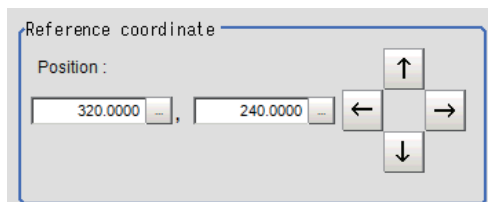

- 5 To remeasure on the displayed image and set the reference, click the **Measure ref.** button.
- 6 To use data before position compensation for the reference setting coordinates, place a check at *Use point coordinate before scroll*.

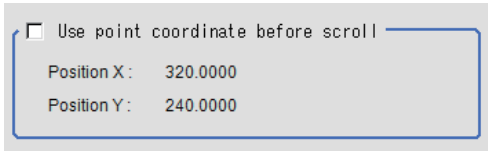

Referencing a Unit

Set a reference by referencing a detection point unit with registered X coordinate, Y coordinate and angle data.

- 1 In the Item tab area, click **Ref. setting**.
In the *Display* area, the current reference position will be displayed as the crosshair cursor.
- 2 In the *Method* area, select *Unit*.

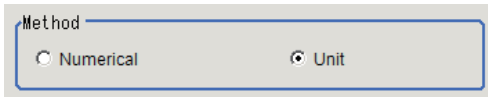

- 3 In the *Unit* area, select a detection point unit in the scene.

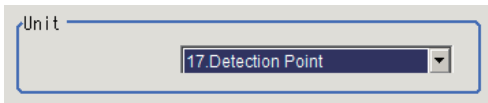

Performing the next measurement will display the reference.

2-18-5 Measurement Parameters (Intersection)

Set the measurement conditions of intersection coordinates.

- 1 In the Item tab area, click **Measurement**.
- 2 In the *Figure select* area, select the lines to be set.
- 3 In the *Display position* area, set the region number if the region is enabled.

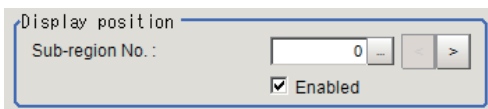
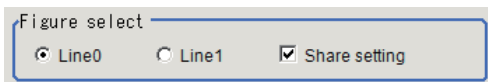

Setting item	Setting value [Factory default]	Description
Sub-region No.	0 to 3,999 [0]	Specify the <i>Sub-region No.</i> for which the edge profile is displayed.

Setting item	Setting value [Factory default]	Description
Enabled	<ul style="list-style-type: none"> [Checked] Unchecked 	Specify enable/disable for the displayed <i>Sub-region No.</i> . When disabled (unchecked) is specified, that <i>Sub-region No.</i> is not measured.

4 If necessary, specify a value for each item in the *Measurement condition* area.

- For color cameras:

Edge Color Not Specified

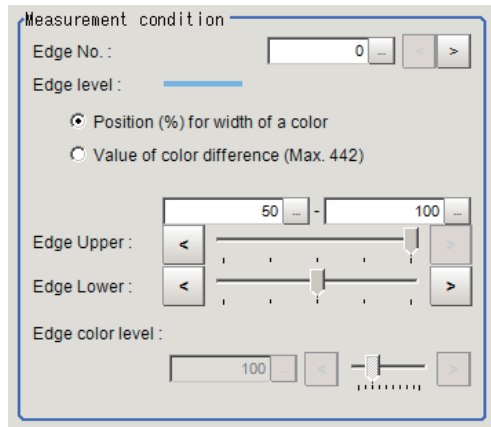

Edge Color Specified

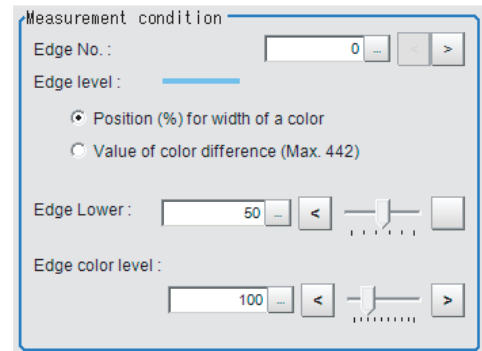

Setting item	Setting value [Factory default]	Description
Edge No.	0 to 99 [0]	Specify the edge number used to extract edges. <i>Edge numbers</i> are assigned to detected edges starting from 0 and going on in the direction from the start point (the arrow point) to the end point (the direction of arrow) in the selected area.
Edge Upper (only when edge color is not specified) Edge Lower	<ul style="list-style-type: none"> Position (%) for width of a color 0 to 100 [50] to [100] Value of color 0 to 442 [20] to [442] 	Set a range of a color difference level with which the edge is detected. For details, refer to <i>Appendixes Measurement Mechanism Edge Detection Measurement</i> in the <i>Vision System FH/FHV Series User's Manual (Cat. No. Z365)</i> .
Edge color level	0 to 442 [100]	This emphasis level can be specified only if the edge color to detect is specified.

- For monochrome cameras:

When the *Measurement type* is *Projection*:

When the *Measurement type* is *Derivation*:

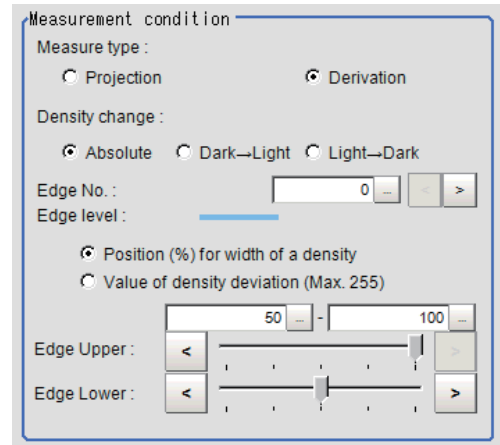
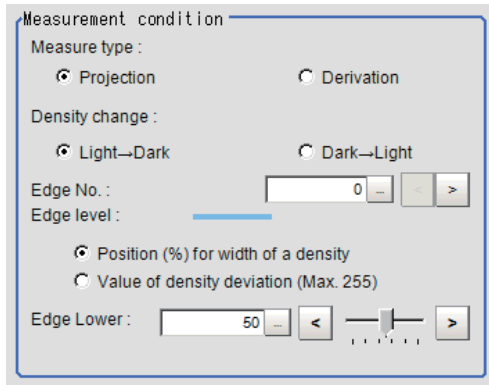

Setting item	Setting value [Factory default]	Description
Measure type	<ul style="list-style-type: none"> [Projection] Derivation 	<p>As the <i>Measurement type</i>, specify either <i>Projection</i> or <i>Derivation</i>.</p> <p>For details, refer to <i>Appendixes Measurement Mechanism Edge Detection Measurement</i> in the <i>Vision System FH/FHV Series User's Manual (Cat. No. Z365)</i>.</p>
Density change	<ul style="list-style-type: none"> Absolute (only when the <i>Measure type</i> is <i>Derivation</i>) [Dark → Light] Light → Dark 	<p>Select whether a black-to-white change or a white-to-black change should be recognized as a density change in the specified region.</p>
Edge No.	0 to 99 [0]	<p>Specify the edge number used to extract edges.</p> <p><i>Edge numbers</i> are assigned to detected edges starting from 0 and going on in the direction from the start point (the arrow point) to the end point (the direction of arrow) in the selected area.</p>
Edge Upper Edge Lower	<ul style="list-style-type: none"> Position (%) for width of a density 0 to 100 [50] to [100] Value of density 0 to 255 [20] to [255] 	<p>Select the density change level to be detected as edges.</p> <p>The upper limit of edges can be set only when the <i>Measure type</i> is <i>Derivation</i>.</p> <p>For details, refer to <i>Appendixes Measurement Mechanism Edge Detection Measurement</i> in the <i>Vision System FH/FHV Series User's Manual (Cat. No. Z365)</i>.</p>

5 If necessary, set each item in the *Noise removal* area.

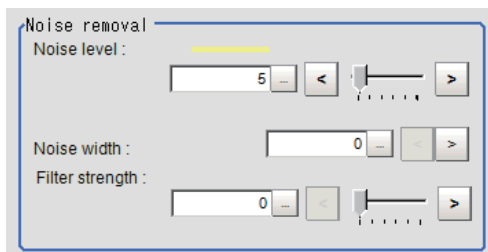

Setting item	Setting value [Factory default]	Description
Noise level	<ul style="list-style-type: none"> For color cameras: 0 to 442 [5] For mono-chrome cameras: 0 to 255 [5] 	When edges are incorrectly detected due to noise, increase this value. For details, refer to <i>Appendixes Measurement Mechanism Edge Detection Measurement</i> in the <i>Vision System FH/FHV Series User's Manual (Cat. No. Z365)</i> .
Noise width	0 to 9,999 [0]	Set the width for judging noise. When detection is affected by noise, increase this value. For details, refer to <i>Appendixes Measurement Mechanism Edge Detection Measurement</i> in the <i>Vision System FH/FHV Series User's Manual (Cat. No. Z365)</i> .
Filter strength	0 to 100 [0]	If a valley appears in the histogram around the edge threshold value due to noises, smoothen the edge profile using a filter to prevent wrong error detection from being detected. Strengthening the filter smoothen the edge profile further.

- 6** In the *Approximate line* area, specify the point to be used for the calculation of approximate lines.

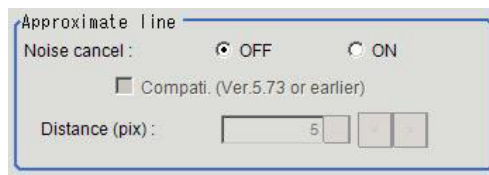

Setting item	Setting value [Factory default]	Description
Noise cancel	<ul style="list-style-type: none"> ON [OFF] 	When placing a check at <i>ON</i> , an approximate line is calculated by excluding the points with large deviation among the measured points.
Rate	0 to 100 [50]	Set the ratio of measurement points used for approximate straight line calculation to all measurement points. When there is considerable noise, reducing this value enables calculation of an approximate straight line with many of the noise points removed. When there is little noise, increasing this value enables calculation of a high-accuracy straight line using many measurement points. *1
Distance (pix)	0 to 10,000 [5]	Sets the degree of "Noise cancel" with a distance to the approximate line. *2
Compati. (Ver.5.73 or earlier)	<ul style="list-style-type: none"> Checked [Unchecked] 	Sets the compatible mode for "Noise cancel". Check this when scene data before Ver.5.73 was loaded.

*1. When *Noise cancel* is *ON* and *Compati. (Ver.5.73 or earlier)* is checked, this is displayed.

*2. When *Noise cancel* is *ON* and *Compati. (Ver.5.73 or earlier)* is unchecked, this is displayed.

**Precautions for Correct Use**

When using the compatibility mode (Ver. 5.73 or earlier) to calculate an approximate line, be sure to control the number of edge measurement points no more than 100.

2-18-6 Judgement Condition (Intersection)

Specify the range to be judged as OK.

- 1** In the Item Tab area, click **Judgement**.
- 2** Set up the judgment condition.

**Additional Information**

The values beside each item are measurement results of the displayed image. Take these values into consideration to determine the upper and lower limit values.

Setting item	Setting value	Description
Intersection X	-99,999.9999 to 99,999.9999	Set the range of X coordinates of intersection that is judged to be OK.
Intersection Y	-99,999.9999 to 99,999.9999	Set the range of Y coordinates of intersection that is judged to be OK.
Angle	0.0000 to 180.0000	Set the angle formed by two lines that are judged to be OK.
Lost point count (Line 0)	0 to 4,000	Set the lost point count to be judged as OK.
Lost point count (Line 1)	0 to 4,000	

2-18-7 Output Parameters (Intersection)

Specify how to treat the coordinates to be output to the external device as measurement results. This item can be changed if necessary. Normally, the factory default value will be used.

**Precautions for Correct Use**

After setting up the measurement parameters, changing the output parameters will cause measurement results to vary accordingly. If the output parameters have been changed, re-specify the measurement, too.

- 1** Click **Output parameter** in the Item tab area.
- 2** Specify each of the following items.

Setting item	Setting value [Factory default]	Description
Output coordinates	<ul style="list-style-type: none"> • [After scroll] • Before scroll 	As measurement results, select whether to output coordinate values to external devices before or after the position deflection correction is applied.

Setting item	Setting value [Factory default]	Description
Calibration	<ul style="list-style-type: none"> • ON • [OFF] 	Select whether to reflect the calibration in the values output to the external device as measurement results. <ul style="list-style-type: none"> • ON: Output the coordinates converted into actual dimensions. • OFF: Output the camera coordinate values.
Reflect to overall judgment	<ul style="list-style-type: none"> • [ON] • OFF 	Enables choosing whether or not the judgement results of this processing unit is reflected in the scene overall judgment.



Additional Information

For output coordinates and calibration, refer to *Appendixes Measurement Mechanism Handling Coordinates* in the *Vision System FH/FHV Series User's Manual (Cat. No. Z365)*.

2-18-8 Key Points for Test Measurement and Adjustment (Intersection)

The following content is displayed in the *Detail result* area as text.

Displayed item	Description
Judge	Judgment results 0: No judgment (unmeasured) 1: Judgment result OK -1: Judgment result NG -10: Error (image format mismatch) -11: Error (unregistered model) -12: Error (insufficient memory) -20: Error (other errors)
Intersection coordinate X	X coordinate of measured intersection
Intersection coordinate Y	Y coordinate of measured intersection
Angle	Angle of measured 2 lines
Lost point count (line 0)	Lost point count of measured line 0
Lost point count (line 1)	Lost point count of measured line 1

Key Points for Adjustment (Intersection)

Adjust the setting parameters referring to the following points.

● When judgement is NG

Parameter to be adjusted	Remedy
Region setting	Confirm that the approximate line calculated for line 0 intersects with the approximate line calculated for line 1. If the approximate lines are parallel, a judgement will be NG.

● When approximate lines are not stable due to noise

Parameter to be adjusted	Remedy
Measurement parameter	Use the noise removal function to make sure approximate lines are measured stably.

2-18-9 Measurement Results for Which Output Is Possible (Intersection)

The following values can be output using processing items related to result output. It is also possible to reference measurement values from calculation expressions and other processing units.

Measurement items	Character string	Description
Judge	JG	Judgment results 0: No judgment (unmeasured) 1: Judgment result OK -1: Judgment result NG -10: Error (image format mismatch) -11: Error (unregistered model) -12: Error (insufficient memory) -20: Error (other errors)
Intersection coordinate X	X	X coordinate of intersection
Intersection coordinate Y	Y	Y coordinate of intersection
Angle	TH	Angle between two lines
Ref. position X	SX	Ref. position X
Ref. position Y	SY	Ref. position Y
Peak edge position X of line 0	PEEKX0	X coordinate of the edge of line 0 that is the furthest from the start point of the measurement region
Peak edge position Y of line 0	PEEKY0	Y coordinate of the edge of line 0 that is the furthest from the start point of the measurement region
Bottom edge position X of line 0	BOTTOMX0	X coordinate of the edge of line 0 that is the closest from the start point of the measurement region
Bottom edge position Y of line 0	BOTTOMY0	Y coordinate of the edge of line 0 that is the closest from the start point of the measurement region
Edge position X Ave. of line 0	AVEX0	The average of X coordinates of all the edges of line 0
Edge position Y Ave. of line 0	AVEY0	The average of Y coordinates of all the edges of line 0
Long distance Max. of line 0	PMAXD0	The maximum distance between the approximate line and edge position of line 0 (plus direction)
Long distance Min. of line 0	PMIND0	The minimum distance between the approximate line and edge position of line 0 (plus direction)
Short distance Max. of line 0	BMAXD0	The maximum distance between the approximate line and edge position of line 0 (minus direction)
Short distance Min. of line 0	BMIND0	The minimum distance between the approximate line and edge position of line 0 (minus direction)
Deviation of line 0	DEV0	Concave and convex deviation of line 0
Angle of line 0	LINETH0	The line 0's inclination to the measurement region
Lost point count of line 0	LOST0	Number of regions for which the detection of edges of line 0 has failed

Measurement items	Character string	Description
Line parameter A of line 0	A0	A in the expression for the approximate line of line 0 $AX + BY + C = 0$.
Line parameter B of line 0	B0	B in the expression for the approximate line of line 0 $AX + BY + C = 0$.
Line parameter C of line 0	C0	C in the expression for the approximate line of line 0 $AX + BY + C = 0$.
Peak edge position X of line 1	PEEKX1	X coordinate of the edge of line 1 that is the furthest from the start point of the measurement region
Peak edge position Y of line 1	PEEKY1	Y coordinate of the edge of line 1 that is the furthest from the start point of the measurement region
Bottom edge position X of line 1	BOTTOMX1	X coordinate of the edge of line 1 that is the closest from the start point of the measurement region
Bottom edge position Y of line 1	BOTTOMY1	Y coordinate of the edge of line 1 that is the closest from the start point of the measurement region
Edge position X Ave. of line 1	AVEX1	The average of X coordinates of all the edges of line 1
Edge position Y Ave. of line 1	AVEY1	The average of Y coordinates of all the edges of line 1
Long distance Max. of line 1	PMAXD1	The maximum distance between the approximate line and edge position of line 1 (plus direction)
Long distance Min. of line 1	PMIND1	The minimum distance between the approximate line and edge position of line 1 (plus direction)
Short distance Max. of line 1	BMAXD1	The maximum distance between the approximate line and edge position of line 1 (minus direction)
Short distance Min. of line 1	BMIND1	The minimum distance between the approximate line and edge position of line 1 (minus direction)
Deviation of line 1	DEV1	Concave and convex deviation of line 1
Angle of line 1	LINETH1	The line 1's inclination to the measurement region
Lost point count of line 1	LOST1	No. of regions for which the detection of edges of line 1 has failed
Line parameter A of line 1	A1	A in the expression for the approximate line of line 1 $AX + BY + C = 0$
Line parameter B of line 1	B1	B in the expression for the approximate line of line 1 $AX + BY + C = 0$
Line parameter C of line 1	C1	C in the expression for the approximate line of line 1 $AX + BY + C = 0$

2-18-10 External Reference Tables (Intersection)

No.	Data name	Data ident	Set/Get	Data range
0	Judge	judge	Get only	0: No judgment (unmeasured), 1: Judgment result OK, -1: Judgment result NG, -10: Error (image format mismatch), -11: Error (unregistered model), -12: Error (insufficient memory), -20: Error (other errors)
1	Intersection coordinate X	crossPosX	Get only	-99,999.9999 to 99,999.9999

No.	Data name	Data ident	Set/Get	Data range
2	Intersection coordinate Y	crossPosY	Get only	-99,999.9999 to 99,999.9999
3	Angle	angle	Get only	0 to 180
4	Reference coordinate X	referenceX	Get only	0 to 9,999
5	Reference coordinate Y	referenceY	Get only	0 to 9,999
10	Line 0 peak edge position X	peekEdgePosX0	Get only	0 to 99,999.9999
11	Line 0 peak edge position Y	peekEdgePosY0	Get only	0 to 99,999.9999
12	Line 0 bottom edge position X	bottomEdgePosX0	Get only	0 to 99,999.9999
13	Line 0 bottom edge position Y	bottomEdgePosY0	Get only	0 to 99,999.9999
14	Line 0 average edge position X	aveEdgePosX0	Get only	-1 to 99,999.9999
15	Line 0 average edge position Y	aveEdgePosY0	Get only	-1 to 99,999.9999
16	Line 0 maximum long distance	maxPeakDist0	Get only	-1 to 99,999.9999
17	Line 0 minimum long distance	minPeakDist0	Get only	-1 to 99,999.9999
18	Line 0 maximum short distance	maxBottomDist0	Get only	-1 to 99,999.9999
19	Line 0 minimum short distance	minBottomDist0	Get only	-1 to 99,999.9999
20	Line 0 deviation	deviation0	Get only	-1 to 99,999.9999
21	Line 0 line angle	lineAngle0	Get only	-180 to 180
22	Line 0 lost point	lostPoint0	Get only	0 to 4,000
23	Line 0 line component A	coefficientA0	Get only	-99,999.9999 to 99,999.9999
24	Line 0 line component B	coefficientB0	Get only	-99,999.9999 to 99,999.9999
25	Line 0 line component C	coefficientC0	Get only	-99,999.9999 to 99,999.9999
30	Line 1 peak edge position X	peekEdgePosX1	Get only	0 to 99,999.9999
31	Line 1 peak edge position Y	peekEdgePosY1	Get only	0 to 99,999.9999
32	Line 1 bottom edge position X	bottomEdgePosX1	Get only	0 to 99,999.9999
33	Line 1 bottom edge position Y	bottomEdgePosY1	Get only	0 to 99,999.9999
34	Line 1 average edge position X	aveEdgePosX1	Get only	-1 to 99,999.9999
35	Line 1 average edge position Y	aveEdgePosY1	Get only	-1 to 99,999.9999
36	Line 1 maximum long distance	maxPeakDist1	Get only	-1 to 99,999.9999

No.	Data name	Data ident	Set/Get	Data range
37	Line 1 minimum long distance	minPeakDist1	Get only	-1 to 99,999.9999
38	Line 1 maximum short distance	maxBottomDist1	Get only	-1 to 99,999.9999
39	Line 1 minimum short distance	minBottomDist1	Get only	-1 to 99,999.9999
40	Line 1 deviation	deviation1	Get only	-1 to 99,999.9999
41	Line 1 line angle	lineAngle1	Get only	-180 to 180
42	Line 1 lost point	lostPoint1	Get only	0 to 4,000
43	Line 1 linear coefficient A	coefficientA1	Get only	-99,999.9999 to 99,999.9999
44	Line 1 linear coefficient B	coefficientB1	Get only	-99,999.9999 to 99,999.9999
45	Line 1 linear coefficient C	coefficientC1	Get only	-99,999.9999 to 99,999.9999
101	Output coordinate	outputCoordinate	Set/Get	0: After scroll 1: Before scroll
102	Calibration	calibration	Set/Get	0: OFF, 1: ON
103	Reflect to overall judgement	overallJudge	Set/Get	0: ON, 1: OFF
120	Reference coordinate X	referencePosX	Set/Get	0 to 99,999.9999
121	Reference coordinate Y	referencePosY	Set/Get	0 to 99,999.9999
122	Share setting (edge color specification)	shareSettingColor	Set/Get	0: Not shared, 1: Shared
123	Share setting (measurement parameters)	shareSetting	Set/Get	0: Not shared, 1: Shared
124	Selected line number	lineNo	Set/Get	0: Line0, 1: Line1
130	Intersection X coordinate upper limit	upperCrossPointX	Set/Get	-99,999.9999 to 99,999.9999
131	Intersection X coordinate lower limit	lowerCrossPointX	Set/Get	-99,999.9999 to 99,999.9999
132	Intersection Y coordinate upper limit	upperCrossPointY	Set/Get	-99,999.9999 to 99,999.9999
133	Intersection Y coordinate lower limit	lowerCrossPointY	Set/Get	-99,999.9999 to 99,999.9999
134	Angle upper limit	upperCrossAngle	Set/Get	0 to 180
135	Angle lower limit	lowerCrossAngle	Set/Get	0 to 180
136	Lost point (line 0) upper limit	upperLostPoint0	Set/Get	0 to 4,000
137	Lost point (line 0) lower limit	lowerLostPoint0	Set/Get	0 to 4,000
138	Lost point (line 1) upper limit	upperLostPoint1	Set/Get	0 to 4,000
139	Lost point (line 1) lower limit	lowerLostPoint1	Set/Get	0 to 4,000
200	Edge color specification (line 0)	colorSpecification0	Set/Get	0: No color specification 1: With color specification
201	Edge color R (line 0)	colorR0	Set/Get	0 to 255

No.	Data name	Data ident	Set/Get	Data range
202	Edge color G (line 0)	colorG0	Set/Get	0 to 255
203	Edge color B (line 0)	colorB0	Set/Get	0 to 255
204	Difference R (line 0)	colorDevR0	Set/Get	0 to 127
205	Difference G (line 0)	colorDevG0	Set/Get	0 to 127
206	Difference B (line 0)	colorDevB0	Set/Get	0 to 127
207	Edge detection mode (line 0)	detectionMode0	Set/Get	0: Specified color IN, 1: Specified color OUT
208	Edge No. (line 0)	edgeNo0	Set/Get	0 to 99
209	Edge level (line 0)	edgeLevel0	Set/Get	0 to 100
210	Noise level (line 0)	noiseLevel0	Set/Get	Color camera: 0 to 442 Monochrome camera: 0 to 255
211	Noise width (line 0)	noiseWidth0	Set/Get	0 to 9,999
212	Edge color enhancement level (line 0)	colorLevel0	Set/Get	0 to 442
213	Monochrome edge detection mode (line 0)	monoDetectMode0	Set/Get	0: Light → Dark, 1: Dark →light
214	Edge level absolute value (line 0)	edgeLevelAbs0	Set/Get	Color camera: 0 to 442 Monochrome camera: 0 to 255
215	Edge level specification method (line 0)	edgeLevelKind0	Set/Get	0: %, 1: Absolute value
216	Scan sub-region (line 0)	scanLines0	Set/Get	1 to 4,000
217	Mask size(Filter size) (line 0)	scanWidth0	Set/Get	0 to 200
218	Display area (line 0)	displayRegion0	Set/Get	0 to 3,999
219	Noise cancel (line 0)	noisePointCut0	Set/Get	0: OFF, 1: ON
220	Measure type (line 0)	measureType0	Set/Get	0: Projection, 1: Differential
221	Fix region count (line 0)	separateType0	Set/Get	0: Not fixed, 1: Fixed
222	Monochrome Derivation edge detection mode (line 0)	diffDetectMode0	Set/Get	0: Absolute 1: Dark → Light 2: Light → Dark
223	Edge Level Upper limit (line 0)	edgeLevelUpper0	Set/Get	0 to 100
224	Edge level Upper limit absolute value (line 0)	edgeLevelUpperAbs0	Set/Get	Color camera: 0 to 442 Monochrome camera: 0 to 255
225	Filter Strength (line 0)	filterStrength0	Set/Get	0 to 100
226	Rate (line 0)	fncRate0	Set/Get	0 to 100
250	Edge color specification(line 1)	colorSpecification1	Set/Get	0: No color specification 1: With color specification
251	Edge color R (line 1)	colorR1	Set/Get	0 to 255
252	Edge color G (line 1)	colorG1	Set/Get	0 to 255
253	Edge color B (line 1)	colorB1	Set/Get	0 to 255
254	Difference R (line 1)	colorDevR1	Set/Get	0 to 127
255	Difference G (line 1)	colorDevG1	Set/Get	0 to 127
256	Difference B (line 1)	colorDevB1	Set/Get	0 to 127

No.	Data name	Data ident	Set/Get	Data range
257	Edge detection mode (line 1)	detectionMode1	Set/Get	0: Specified color IN, 1: Specified color OUT
258	Edge No. (line 1)	edgeNo1	Set/Get	0 to 99
259	Edge level (line 1)	edgeLevel1	Set/Get	0 to 100
260	Noise level (line 1)	noiseLevel1	Set/Get	Color camera: 0 to 442 Monochrome camera: 0 to 255
261	Noise width (line 1)	noiseWidth1	Set/Get	0 to 9,999
262	Edge color enhancement level (line 1)	colorLevel1	Set/Get	0 to 442
263	Monochrome edge detection mode (line 1)	monoDetectMode1	Set/Get	0: Light → Dark, 1: Dark → light
264	Edge level absolute value (line 1)	edgeLevelAbs1	Set/Get	Color camera: 0 to 442 Monochrome camera: 0 to 255
265	Edge level specification method (line 1)	edgeLevelKind1	Set/Get	0: %, 1: Absolute value
266	Scan sub-region (line 1)	scanLines1	Set/Get	1 to 4,000
267	Mask size(Filter size) (line 1)	scanWidth1	Set/Get	0 to 200
268	Display area (line 1)	displayRegion1	Set/Get	0 to 3,999
269	Noise cancel (line 1)	noisePointCut1	Set/Get	0: OFF, 1: ON
270	Measure type (line 1)	measureType1	Set/Get	0: Projection, 1: Differential
271	Fix region count (line 1)	separateType1	Set/Get	0: Not fixed, 1: Fixed
272	Monochrome Derivation edge detection mode (line 1)	diffDetectMode1	Set/Get	0: Absolute 1: Dark → Light 2: Light → Dark
273	Edge Level Upper limit (line 1)	edgeLevelUpper1	Set/Get	0 to 100
274	Edge level Upper limit absolute value (line 1)	edgeLevelUpperAbs1	Set/Get	Color camera: 0 to 442 Monochrome camera: 0 to 255
275	Filter Strength (line 1)	filterStrength1	Set/Get	0 to 100
276	Rate (line 1)	fncRate1	Set/Get	0 to 100
278	Setting unit of reference coordinate	refUnitNo	Set/Get	-1 to 9,999
279	Setting type of reference coordinate	refSettingType	Set/Get	0: Numerical, 1: Unit
280	Use point coordinate before scroll	beforeScrollRefMode	Set/Get	0: Not use, 1: Use
281	Reference X before scroll	beforeScrollRefPosX	Set/Get	-99,999.9999 to 99,999.9999
282	Reference Y before scroll	beforeScrollRefPosY	Set/Get	-99,999.9999 to 99,999.9999
288	Distance (line 0)	inlierDist0	Set/Get	0 to 10,000
290	Distance (line 1)	inlierDist1	Set/Get	0 to 10,000

No.	Data name	Data ident	Set/Get	Data range
291	Compatibility mode (Ver.5.73 or earlier) (line0)	compMode0	Set/Get	0: OFF, 1: ON
292	Compatibility mode (Ver.5.73 or earlier) (line1)	compMode1	Set/Get	0: OFF, 1: ON
6,002	Format	cameraColor	Set/Get	1: Monochrome camera 2: Color camera
11,000+N (N=0 to 3,999)	Enabled (line 0)	lineA_area_ena- bled0000 to lin- eA_area_ena- bled3999	Set/Get	0: Disable, 1: Enable
15,000+N (N=0 to 3,999)	Enabled (line 1)	lineB_area_ena- bled0000 to lineB_area_ena- bled3999	Set/Get	0: Disable, 1: Enable
30,000+N (N=0 to 3,999)	Edge Position X(line 0)	lineA_edge- PosX0000 to lin- eA_edgePosX3999	Get only	-99,999.9999 to 99,999.9999
40,000+N (N=0 to 3,999)	Edge Position Y(line 0)	lineA_edgePo- sY0000 to lin- eA_edgePosY3999	Get only	-99,999.9999 to 99,999.9999
50,000+N (N=0 to 3,999)	Edge Position X(line 1)	lineB_edge- PosX0000 to lineB_edge- PosX3999	Get only	-99,999.9999 to 99,999.9999
60,000+N (N=0 to 3,999)	Edge Position Y(line 1)	lineB_edgePo- sY0000 to lineB_edgePo- sY3999	Get only	-99,999.9999 to 99,999.9999
90,000	Region0 figure Count	figArea0_count	Set/Get	0 to 1
90,001	Region0 figure0 Type	figArea0_fig0_type	Set/Get	4: Wide line
90,002	Region0 figure0 mode	figArea0_fig0_mode	Set/Get	0: OR
90,009	Region0 figure0 Wide line Start point X	figAr- ea0_fig0_lineW_X0	Set/Get	-99,999 to 99,999
90,010	Region0 figure0 Wide line Start point Y	figAr- ea0_fig0_lineW_Y0	Set/Get	-99,999 to 99,999
90,011	Region0 figure0 Wide line End point X	figAr- ea0_fig0_lineW_X1	Set/Get	-99,999 to 99,999
90,012	Region0 figure0 Wide line End point Y	figAr- ea0_fig0_lineW_Y1	Set/Get	-99,999 to 99,999
90,013	Region0 figure0 Wide line Width	figAr- ea0_fig0_lineW_W	Set/Get	0 to 99,999
90,099	Region0 figure Up- date	figArea0_update	Set only	1: Update

No.	Data name	Data ident	Set/Get	Data range
92,000	Region1 figure Count	figArea1_count	Set/Get	0 to 1
92,001	Region1 figure0 Type	figArea1_fig0_type	Set/Get	4: Wide line
92,002	Region1 figure0 mode	figArea1_fig0_mode	Set/Get	0: OR
92,009	Region1 figure0 Wide line Start point X	figArea1_fig0_lineW_X0	Set/Get	-99,999 to 99,999
92,010	Region1 figure0 Wide line Start point Y	figArea1_fig0_lineW_Y0	Set/Get	-99,999 to 99,999
92,011	Region1 figure0 Wide line End point X	figArea1_fig0_lineW_X1	Set/Get	-99,999 to 99,999
92,012	Region1 figure0 Wide line End point Y	figArea1_fig0_lineW_Y1	Set/Get	-99,999 to 99,999
92,013	Region1 figure0 Wide line Width	figArea1_fig0_lineW_W	Set/Get	0 to 99,999
92,099	Region1 figure Update	figArea1_update	Set only	1: Update

2-19 Color Data

Inspect by finding the average color of the measurement region and using its difference from the registered reference color and the color variation in the measurement area. Alternatively, you can only detect the color tone while neglect the effect of image brightness.

For monochrome cameras, examination is performed by measuring the difference between the average density of the measurement region and the registered reference density (density average), and the density deviation in the measurement region (density deviation).

Used in the Following Case

When measuring the presence of measurement objects:

Example) When re-measuring the presence of electronics components

Measure the presence with the color difference by averaging RGB values of the Measurement region.

The diagram illustrates two measurement scenarios for an electronics component. On the left, labeled 'OK', a green rectangular measurement region contains a solid orange circle representing the component. Below it, the text reads 'Component' and 'Average RGB of Measurement region: 190'. On the right, labeled 'NG (defect components)', the same green measurement region contains a dashed orange circle representing a defect. Below it, the text reads 'Component (defect)' and 'Average RGB of Measurement region: 170'. A horizontal line with a bracket below it connects the two average RGB values, labeled 'Average color difference: 20'.

For monochrome cameras, the presence of electronics components is examined by measuring the difference between the average density of the measurement region and the registered reference density.



Precautions for Correct Use

Processing is different for color images and monochrome images. When the camera type used in the previous setup was changed to color or monochrome type, perform the settings again.

2-19-1 Settings Flow (Color Data)

To set Color Data, follow the steps below.

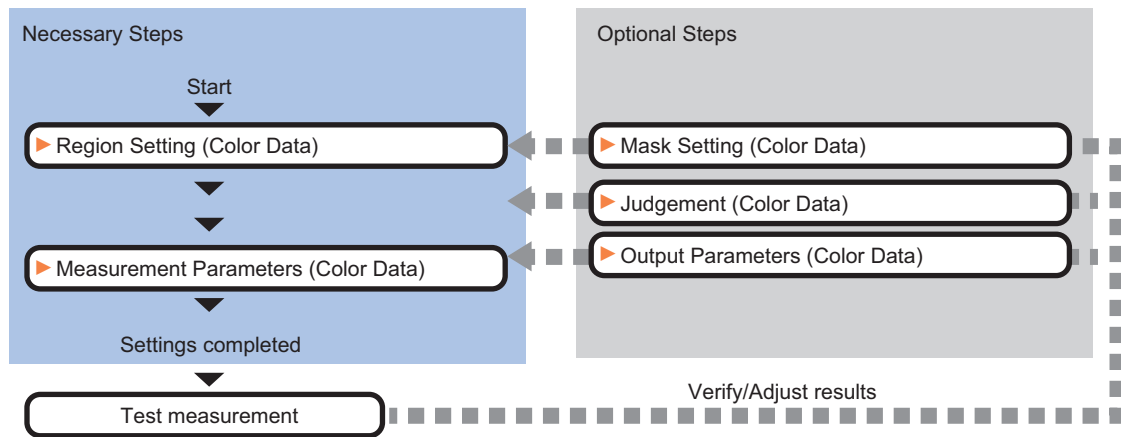

List of Color Data Items

Item	Description
Region setting	Sets the measurement area. It is possible to target the entire screen, but restricting the range can shorten the processing time. <i>2-19-2 Region Setting (Color Data) on page 2-283</i>
Mask setting	Set it when masking a region. The measurement result of another processing item can also be used for masking. <i>2-19-3 Mask Setting (Color Data) on page 2-284</i>
Measurement parameter	Measurement parameter can be changed as needed to address unstable measurement results. <i>2-19-4 Measurement Parameters (Color Data) on page 2-287</i>
Judgment condition	Sets processing conditions for measurement and judgment conditions for measurement results. <i>2-19-5 Judgement Condition (Color Data) on page 2-288</i>
Output parameter	This item can be changed as necessary. Normally, the factory default value will be used. Use the output parameter to specify how to handle the coordinates. <i>2-19-6 Output parameter (Color Data) on page 2-290</i>

2-19-2 Region Setting (Color Data)

Instead of measuring the entire input image, narrowing the measurement area shortens the processing time.

A measurement region for **Color Data** can be specified as a rectangle, circle (ellipse), circumference, or polygon.



Additional Information

Up to 8 graphs can be used together to draw the measured region. Complex areas can be drawn through image integration or by removing unnecessary sections from the measurement region.

- 1 In the Item tab area, click **Region setting**.

- 2 Use the drawing tools to set the measurement region.
- 3 Click **OK** in the *Figure setting* area.
 - **OK**: Changes the settings and returns to the previous menu.
 - **Cancel**: Changes are discarded. Returns to the previous menu.
 - **Apply**: Updates the settings without leaving edit window.
- 4 To register a color in the region as a reference color, place a check at *Auto update reference color*.

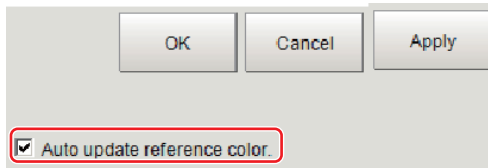

Additional Information

When a check is placed at *Auto update reference color*., the average color within the region is automatically registered as the reference color when the region is registered. Each time the region is updated, the reference color is updated. To hold the reference color constant, uncheck this option and register the reference color with the measurement parameters. Refer to 2-19-4 *Measurement Parameters (Color Data)* on page 2-287.

2-19-3 Mask Setting (Color Data)

Mask the measurement region when measuring it.

There are two types of masks, namely, a static mask that sets the mask region independent of measurement and a dynamic mask that uses images generated in another unit for each measurement

Creating a static mask

A static mask can be created manually or from an image of another unit.

- 1 In the *Mask setting* area, select *Static mask*.

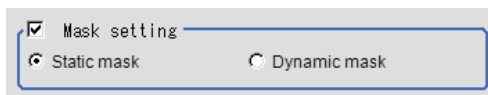

● Generating a mask manually

- 1 In the *Static mask set* area, select *Region extract*.

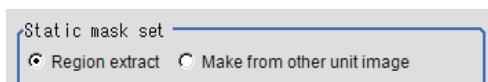

- 2 Select the selection region type OR or NOT and drag an image directly.

A region is created along successive similar colors from the selected place. It is not masked if the selection region type is OR.

It is masked if the selection region type is NOT.

To deselect a selected region, click **Undo**.

To edit a region selected with OR/NOT, click **Selected region edit**.

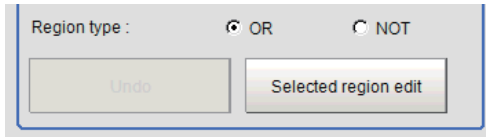

3 Adjust the mask created in the *Static mask setting* area.

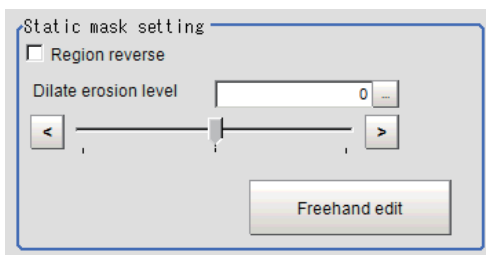

Setting item	Setting value [Factory default]	Description
Region reverse	<ul style="list-style-type: none"> Checked [Unchecked] 	Place a check to revert the created mask region.
Dilate erosion level	-10 to 10 [0]	Perform fine adjustment on the mask region using expansions/shrinkage. The region is expanded if a positive value is set. The region is shrunk if a negative value is set.

● Creating a static mask from an image of another unit

1 In the *Static mask set* area, select *Make from other unit image*.

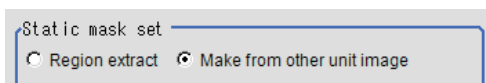

2 Set the unit number and image data number.

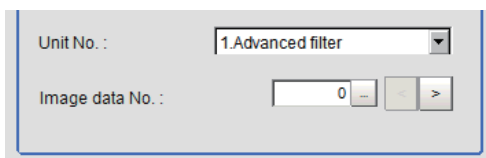

Setting item	Setting value [Factory default]	Description
Unit No.	-	Specify the number of the unit whose image will be referenced. The reference unit should be able to output binarized images. For example, select a labeling filter processing image for advanced filtering.
Image data No.	0 to 3 [0]	If the unit supports advanced filtering, numbers 0 to 3 can be set. Otherwise, it is fixed to 0.

Performing fine adjustment on a static mask

- 1 To perform fine adjustment on a mask region, click **Freehand edit** in the *Static mask setting* area.

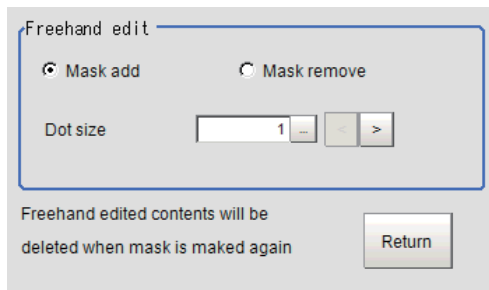

Setting item	Setting value [Factory default]	Description
Freehand edit	<ul style="list-style-type: none"> • [Mask add] • Mask remove 	Select a process performed using the free hand edit.
Dot size	1 to 20 [1]	Set the size of dots used when drawing images on the screen.

- 2 Click **Return** to exit the free hand edit.

Clearing the static mask setting

- 1 To clear the static mask setting, click **Clear**.

Creating a dynamic mask

- 1 In the *Mask setting* area, select *Dynamic mask*.

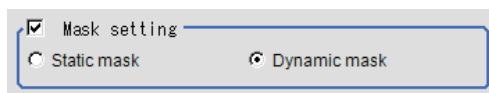

- 2 Set the unit number and image data number in the *Unit reference* area.

Setting item	Setting value [Factory default]	Description
Unit No.	-	Set the number of the unit being referred to for the mask region. The reference unit should be able to output binarized images. For example, select a labeling filter processing image for advanced filtering.
Image data No.	0 to 3 [0]	If the unit supports advanced filtering, numbers 0 to 3 can be set. Otherwise, it is fixed to 0.

Setting display

Perform the display setting if required.

Setting item	Setting value [Factory default]	Description
Image type	<ul style="list-style-type: none"> • Measure image • Mask binary image • [Mask and image] 	Select the type of an image to be displayed.
Mask region color	<ul style="list-style-type: none"> • [Black] • White • Red • Green • Blue 	Select the display color of the mask region. A part of color which is specified in <i>Mask region color</i> is not measured.

2-19-4 Measurement Parameters (Color Data)

For color cameras, set the reference color.

- 1 In the Item tab area, click **Measurement**.
- 2 If necessary, check the *Normalization* option in the *Correction condition* area.
Normally, the factory default value will be used. After changing a setting, check whether measurement can be done properly by performing an actual measurement.

Setting item	Setting value [Factory default]	Description
Normalization	<ul style="list-style-type: none"> • Checked • [Unchecked] 	Specify whether to normalize the brightness in calculating the color difference. When checked, the result is not affected by the total brightness and only the color tone can be detected.

3 In the *Reference color* area, specify the reference color.

This operation is not needed when there is a check at *Auto update reference color*. when the region is registered.

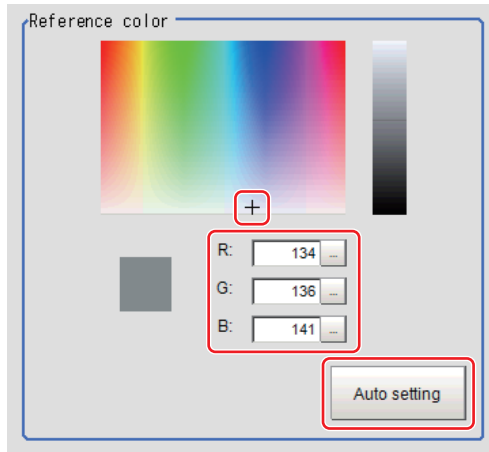

Setting item	Setting value [Factory default]	Description
Color chart	-	Clicking the color chart displays the RGB values for the specified color at the bottom.
R, G, B	0 to 255 [255]	Set the RGB values with numbers.
Auto setting	-	If you click Auto setting , the average color of the measurement region is displayed as the reference color.

2-19-5 Judgement Condition (Color Data)

This item specifies the judgement condition for measurement results.

1 When the setting has been changed, click **Measure** in the *Detail* area to verify whether measurements can be made correctly.

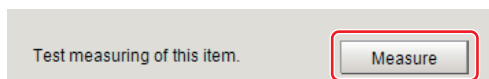

2 In the *RGB Judgement condition* area, set the judgement condition.

Setting item	Setting value	Description
Color difference	0 to 442	Specify the upper and lower limit values for the difference between the average color of the measurement region and the reference color.
Color deviation	0 to 221	Specify the upper and lower limit values for the deviation of the average color in the measurement region

- 3 HSV parameters can also be used to set the judgement condition.
- 4 Place a check at **Automatic**.
- 5 In the Image Display area, specify the color range you want to detect by dragging the cursor from the upper left corner to the lower right corner of that area.
The color of the specified area is automatically set.

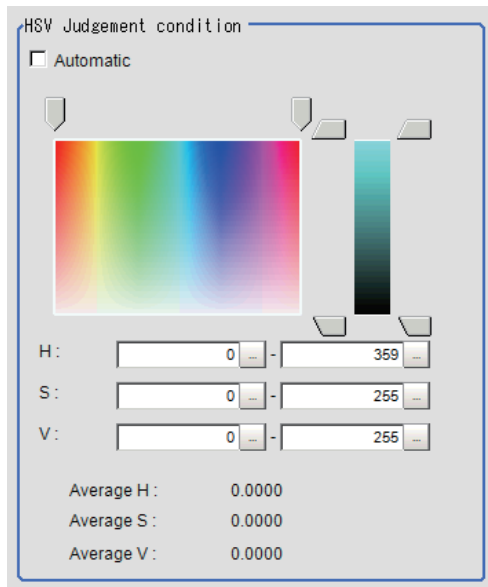

Setting item	Setting value [Factory default]	Description
Automatic	<ul style="list-style-type: none"> • Checked • [Unchecked] 	Specifies the color to be measured on the image automatically sets the <i>hue</i> , <i>saturation</i> , and <i>brightness</i> .
H	[0] to [359]	Sets the hue (difference in hue).
S	[0] to [255]	Sets the saturation (difference in saturation).
V	[0] to [255]	Sets the vividness (difference in vividness).

For monochrome cameras

- 1 When the setting has been changed, click **Measure** in the *Detail* area to verify whether measurements can be made correctly.
- 2 Set up the judgement condition.

Setting item	Setting value [Factory default]	Description
Density average	0 to 255	Specifies the upper and lower limit values for judging the average density of the measurement region.
Density deviation	0 to 127	Specifies the upper and lower limit values for the deviation of the average density in the measurement region.

2-19-6 Output parameter (Color Data)

Select whether or not to reflect the judgment results of this processing unit to the overall judgment of the scene.

- 1 In the Item tab area, click **Output parameter**.
- 2 Select whether or not to reflect it to the overall judgment in *Reflect to overall judgement* area.

Setting item	Setting value [Factory default]	Description
Reflect to overall judgment	<ul style="list-style-type: none"> • [ON] • OFF 	Enables choosing whether or not the judgement results of this processing unit is reflected in the scene overall judgment.

2-19-7 Key Points for Test Measurement and Adjustment (Color Data)

The following content is displayed in the *Detail result* area as text.

- For color cameras

Displayed item	Description
Judge	Judgment results 0: No judgment (unmeasured) 1: Judgment result OK -1: Judgment result NG -10: Error (image format mismatch) -11: Error (unregistered model) -12: Error (insufficient memory) -20: Error (other errors)
R average	R (red) element average value
G average	G (green) element average value
B average	B (blue) element average value
Color difference	The color difference between the average color and reference color in the measurement region
Color deviation	Color deviation in the measurement region
H average	Average H (Hue) component value
S average	Average S (Saturation) component value
V average	Average V (Value) component value

- For monochrome cameras

Displayed item	Description
Judge	Judgment results 0: No judgment (unmeasured) 1: Judgment result OK -1: Judgment result NG -10: Error (image format mismatch) -11: Error (unregistered model) -12: Error (insufficient memory) -20: Error (other errors)
Density average	Average density in the measurement region
Density deviation	Color deviation in the measurement region

Key Points for Adjustment (Color Data)

Adjust the setting parameters referring to the following points.

● When the measurement results are unstable

Parameter to be adjusted	Remedy
Measurement parameter	For a color camera, place a check at <i>Normalization</i> .

● When the processing speed is slow

Parameter to be adjusted	Remedy
Region setting	Make the search region as small as possible.

2-19-8 Measurement Results for Which Output Is Possible (Color Data)

The following values can be output using processing items related to result output. It is also possible to reference measurement values from calculation expressions and other processing units.

- For color cameras

Measurement items	Character string	Description
Judge	JG	Judgment results 0: No judgment (unmeasured) 1: Judgment result OK -1: Judgment result NG -10: Error (image format mismatch) -11: Error (unregistered model) -12: Error (insufficient memory) -20: Error (other errors)
R average	AR	R (red) element average value
G average	AG	G (green) element average value
B average	AB	B (blue) element average value
Color difference	AD	The color difference between the average color and reference color in the measurement region
Color deviation	DV	Color deviation in the measurement region
H average	AH	Average H (Hue) component value
S average	AS	Average S (Saturation) component value
V average	AV	Average V (Value) component value

- For monochrome cameras

Measurement items	Character string	Description
Judge	JG	Judgment results 0: No judgment (unmeasured) 1: Judgment result OK -1: Judgment result NG -10: Error (image format mismatch) -11: Error (unregistered model) -12: Error (insufficient memory) -20: Error (other errors)
Density average	AD	Average density in the measurement region
Density deviation	DV	Color deviation in the measurement region

2-19-9 External Reference Tables (Color Data)

No.	Data name	Data ident	Set/Get	Data range
0	Judge	judge	Get only	0: No judgment (unmeasured), 1: Judgment result OK, -1: Judgment result NG, -10: Error (image format mismatch), -11: Error (unregistered model), -12: Error (insufficient memory), -20: Error (other errors)
5	Average R component value	averageR	Get only	0 to 255
6	Average G component value	averageG	Get only	0 to 255
7	Average B component value	averageB	Get only	0 to 255
8	Color difference	difference	Get only	0 to 442
9	Color deviation	deviation	Get only	0 to 221
10	Density average(monochrome)	monoAverage	Get only	0 to 255
11	Density deviation(monochrome)	monoDeviation	Get only	0 to 127
14	Density average value difference	monoDiffAverage	Get only	0 to 255
15	Density deviation value difference	monoDiffDeviation	Get only	0 to 127
16	H average value	averageH	Get only	0 to 359
17	S average value	averageS	Get only	0 to 255
18	V average value	averageV	Get only	0 to 255
103	Reflect to overall judgement	overallJudge	Set/Get	0: ON, 1: OFF
120	Normalization	normalization	Set/Get	0: OFF, 1: ON
121	Reference color R	referenceR	Set/Get	0 to 255
122	Reference color G	referenceG	Set/Get	0 to 255
123	Reference color B	referenceB	Set/Get	0 to 255
124	Upper limit for color difference	upperDifference	Set/Get	0 to 442

No.	Data name	Data ident	Set/Get	Data range
125	Lower limit for color difference	lowerDifference	Set/Get	0 to 442
126	Upper limit for color deviation	upperDeviation	Set/Get	0 to 221
127	Lower limit for color deviation	lowerDeviation	Set/Get	0 to 221
130	Upper limit for density average(for monochrome cameras only)	monoUpperDiffrence	Set/Get	0 to 255
131	Lower limit for density average(for monochrome cameras only)	monoLowerDifference	Set/Get	0 to 255
132	Upper limit for density deviation(for monochrome cameras only)	monoUpperDeviation	Set/Get	0 to 127
133	Lower limit for density deviation(for monochrome cameras only)	monoLowerDeviation	Set/Get	0 to 127
134	Auto update reference color flag	standardFlag	Set/Get	0 to 1
136	Upper limit for H average value	upperH	Set/Get	0 to 359
137	Lower limit for H average value	lowerH	Set/Get	0 to 359
138	Upper limit for S average value	upperS	Set/Get	0 to 255
139	Lower limit for S average value	lowerS	Set/Get	0 to 255
140	Upper limit for V average value	upperV	Set/Get	0 to 255
141	Lower limit for V average value	lowerV	Set/Get	0 to 255
155	Dynamic mask unit reference no	DynUnitNo	Set/Get	-1 to 9,999
156	Dynamic mask image no	DynImageNo	Set/Get	0 to 99
158	Display image type	ChkChoose	Set/Get	0: Measure image, 1: Mask binary image, 2: Mask and image
164	Mask region display color	maskRegionColor	Set/Get	0: Black, 1: White 2: Red, 3: Green, 4: Blue
6,002	Format	cameraColor	Set/Get	1: Monochrome camera 2: Color camera
90,000	Inspection area figure Count	figArea0_count	Set/Get	0 to 8
90,001	Inspection area figure0 Type	figArea0_fig0_type	Set/Get	8: Rectangle, 16: Ellipse, 64: Circumference, 512: Polygon

No.	Data name	Data ident	Set/Get	Data range
90,002	Inspection area figure0 mode	figArea0_fig0_mode	Set/Get	0: OR, 1: NOT
90,014	Inspection area figure0 Rectangle Upper left position X	figArea0_fig0_box_X0	Set/Get	-99,999 to 99,999
90,015	Inspection area figure0 Rectangle Upper left position Y	figArea0_fig0_box_Y0	Set/Get	-99,999 to 99,999
90,016	Inspection area figure0 Rectangle Lower right position X	figArea0_fig0_box_X1	Set/Get	-99,999 to 99,999
90,017	Inspection area figure0 Rectangle Lower right position Y	figArea0_fig0_box_Y1	Set/Get	-99,999 to 99,999
90,018	Inspection area figure0 Ellipse Center Position X	figArea0_fig0_ellipse_CX	Set/Get	-99,999 to 99,999
90,019	Inspection area figure0 Ellipse Center Position Y	figArea0_fig0_ellipse_CY	Set/Get	-99,999 to 99,999
90,020	Inspection area figure0 Ellipse RadiusX	figArea0_fig0_ellipse_RX	Set/Get	1 to 99,999
90,021	Inspection area figure0 Ellipse RadiusY	figArea0_fig0_ellipse_RY	Set/Get	1 to 99,999
90,025	Inspection area figure0 Circumference Center Position X	figArea0_fig0_circleW_X	Set/Get	-99,999 to 99,999
90,026	Inspection area figure0 Circumference Center Position Y	figArea0_fig0_circleW_Y	Set/Get	-99,999 to 99,999
90,027	Inspection area figure0 Circumference Radius	figArea0_fig0_circleW_R	Set/Get	0 to 99,999
90,028	Inspection area figure0 Circumference Width	figArea0_fig0_circleW_W	Set/Get	0 to 99,999
90,040	Inspection area figure0 Polygon Point Count	figArea0_fig0_polygon_count	Set/Get	3 to 10
90,041	Inspection area figure0 Polygon Point1 Position X	figArea0_fig0_polygon_x0	Set/Get	-99,999 to 99,999
90,042	Inspection area figure0 Polygon Point1 Position Y	figArea0_fig0_polygon_y0	Set/Get	-99,999 to 99,999
90,059	Inspection area figure0 Polygon Point10 Position X	figArea0_fig0_polygon_x9	Set/Get	-99,999 to 99,999
90,060	Inspection area figure0 Polygon Point10 Position Y	figArea0_fig0_polygon_y9	Set/Get	-99,999 to 99,999

No.	Data name	Data ident	Set/Get	Data range
90,099	Inspection area figure Update	figArea0_update	Set only	1: Update
90,101	Inspection area figure1 Type	figArea0_fig1_type	Set/Get	8: Rectangle, 16: Ellipse, 64: Circumference, 512: Polygon
90,201	Inspection area figure2 Type	figArea0_fig2_type	Set/Get	8: Rectangle, 16: Ellipse, 64: Circumference, 512: Polygon
90,301	Inspection area figure3 Type	figArea0_fig3_type	Set/Get	8: Rectangle, 16: Ellipse, 64: Circumference, 512: Polygon
:	:	:	:	:
90,401	Inspection area figure4 Type	figArea0_fig4_type	Set/Get	8: Rectangle, 16: Ellipse, 64: Circumference, 512: Polygon
:	:	:	:	:
90,501	Inspection area figure5 Type	figArea0_fig5_type	Set/Get	8: Rectangle, 16: Ellipse, 64: Circumference, 512: Polygon
:	:	:	:	:
90,601	Inspection area figure6 Type	figArea0_fig6_type	Set/Get	8: Rectangle, 16: Ellipse, 64: Circumference, 512: Polygon
:	:	:	:	:
90,701	Inspection area figure7 Type	figArea0_fig7_type	Set/Get	8: Rectangle, 16: Ellipse, 64: Circumference, 512: Polygon
:	:	:	:	:
92,000	Mask area figure Count	figArea1_count	Set/Get	1
92,001	Mask area figure0 Type	figArea1_fig0_type	Set/Get	8: Rectangle
92,002	Mask area figure0 mode	figArea1_fig0_mode	Set/Get	0: OR
92,014	Mask area figure0 Rectangle Upper left position X	figArea1_fig0_box_X0	Set/Get	-99,999 to 99,999
92,015	Mask area figure0 Rectangle Upper left position Y	figArea1_fig0_box_Y0	Set/Get	-99,999 to 99,999
92,016	Mask area figure0 Rectangle Lower right position X	figArea1_fig0_box_X1	Set/Get	-99,999 to 99,999
92,017	Mask area figure0 Rectangle Lower right position Y	figArea1_fig0_box_Y1	Set/Get	-99,999 to 99,999
92,099	Mask area figure Update	figArea1_update	Set only	1: Update
93,000	Selected area figure Count	figArea2_count	Set/Get	0 to 8
93,001	Selected area figure0 Type	figArea2_fig0_type	Set/Get	8: Rectangle
93,002	Selected area figure0 mode	figArea2_fig0_mode	Set/Get	0: OR, 1: NOT
93,014	Selected area figure0 Rectangle Upper left position X	figArea2_fig0_box_X0	Set/Get	-99,999 to 99,999

No.	Data name	Data ident	Set/Get	Data range
93,015	Selected area figure0 Rectangle Upper left position Y	figArea2_fig0_box_Y0	Set/Get	-99,999 to 99,999
93,016	Selected area figure0 Rectangle Lower right position X	figArea2_fig0_box_X1	Set/Get	-99,999 to 99,999
93,017	Selected area figure0 Rectangle Lower right position Y	figArea2_fig0_box_Y1	Set/Get	-99,999 to 99,999
93,099	Selected area figure Update	figArea2_update	Set only	1: Update
93,101	Selected area figure1 Type	figArea2_fig1_type	Set/Get	8: Rectangle
:	:	:	:	:
93,201	Selected area figure2 Type	figArea2_fig2_type	Set/Get	8: Rectangle
:	:	:	:	:
93,301	Selected area figure3 Type	figArea2_fig3_type	Set/Get	8: Rectangle
:	:	:	:	:
93,401	Selected area figure4 Type	figArea2_fig4_type	Set/Get	8: Rectangle
:	:	:	:	:
93,501	Selected area figure5 Type	figArea2_fig5_type	Set/Get	8: Rectangle
:	:	:	:	:
93,601	Selected area figure6 Type	figArea2_fig6_type	Set/Get	8: Rectangle
:	:	:	:	:
93,701	Selected area figure7 Type	figArea2_fig7_type	Set/Get	8: Rectangle
:	:	:	:	:
93,717	Selected area figure7 Rectangle Lower right position Y	figArea2_fig7_box_Y1	Set/Get	-99,999 to 99,999

2-20 Gravity and Area

Inspect using the area of the specified color.

Used in the Following Case

- Label deviation measurement:

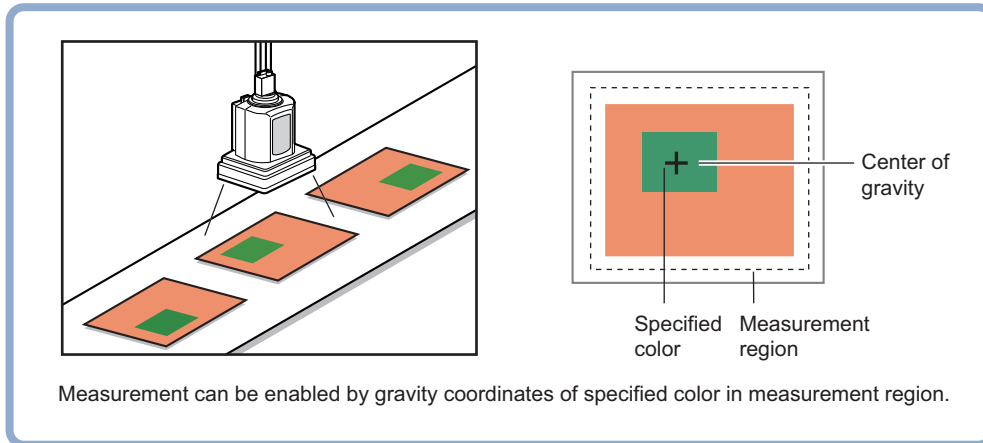

- Detection of defects, contamination, and stains of measurement objects whose appearance is not defined:

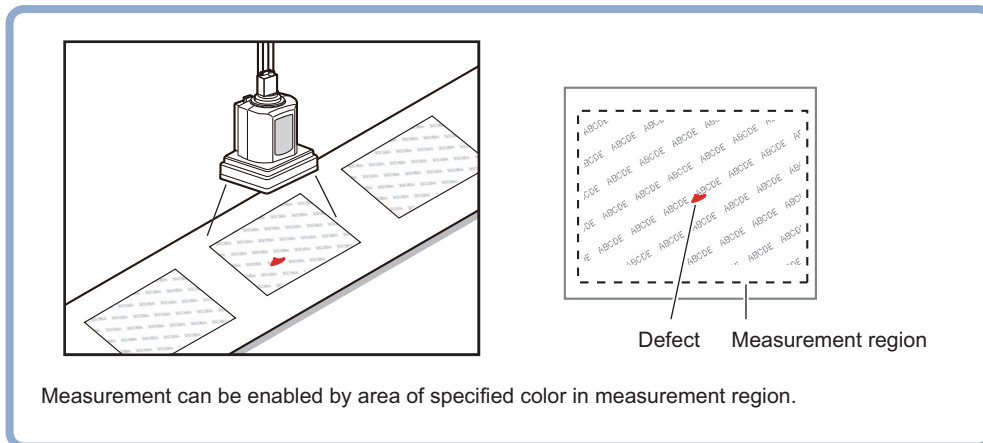

Precautions for Correct Use

Processing is different for color images and monochrome images. When the camera type used in the previous setup was changed to color or monochrome type, perform the settings again.

2-20-1 Settings Flow (Gravity and Area)

To set Gravity and Area, follow the steps below.

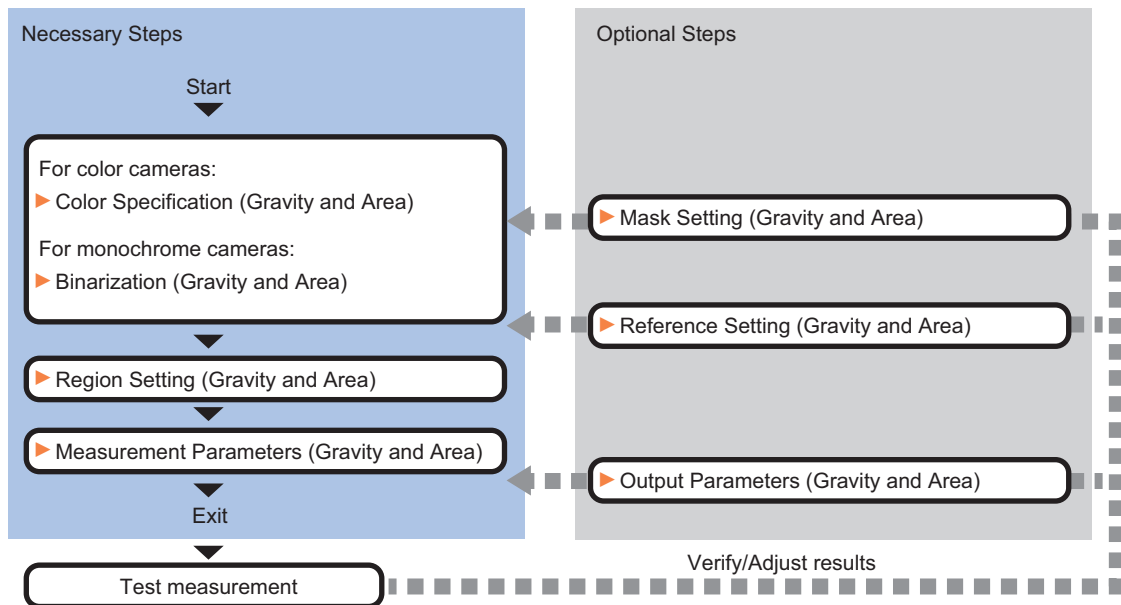

List of Gravity and Area Items

Item	Description
Color (for color cameras only)	This item selects the color whose area and center of gravity are to be measured. Since the color hue, color saturation, and brightness can be selected, then fine-tuning can be performed to colors. <i>2-20-2 Color Specification (Gravity and Area) on page 2-299</i>
Binary (for monochrome cameras only)	This item specifies the binary level for converting 256-tone grayscale images input from the camera into binary images. Converted white pixels are measured. Adjust the binary level so that the measurement object is converted to white pixels. <i>2-20-3 Binarization (Gravity and Area) on page 2-301</i>
Region setting	Sets the measurement area. It is possible to target the entire screen, but restricting the range can shorten the processing time. <i>2-20-4 Region Setting (Gravity and Area) on page 2-301</i>
Mask setting	Set it when masking a region. The measurement result of another processing item can also be used for masking. <i>2-20-5 Mask Setting (Gravity and Area) on page 2-302</i>
Ref. setting	This item can be changed as necessary. Specify the reference position within the camera's field of view. <i>2-20-6 Reference Setting (Gravity and Area) on page 2-305</i>
Measurement parameter	Sets processing conditions for measurement and judgment conditions for measurement results. Specify the upper and lower limit values for the area and the gravity center Measurement parameter can be changed as needed to address unstable measurement results. Normally, the factory default value will be used. <i>2-20-7 Measurement Parameters (Gravity and Area) on page 2-307</i>
Output parameter	This item can be changed as necessary. Normally, the factory default value will be used. Use the output parameter to specify how to handle the coordinates. <i>2-20-8 Output Parameters (Gravity and Area) on page 2-309</i>

2-20-2 Color Specification (Gravity and Area)

When connecting a color camera, specify the color to be measured. There are two specification methods: specifying the color to be extracted in the image or specifying the color with the hue, saturation, and brightness values.

This section describes how to specify colors in an image and gives an example of the procedure for finely adjusting with numeric input afterwards.

- 1** In the Item Tab area, click **Color**.
- 2** Place a check at **Automatic**.
- 3** In the *Image Display* area, specify the color range you want to detect by dragging the cursor from the upper left corner to the lower right corner of that area.
The color of the specified area is automatically set.

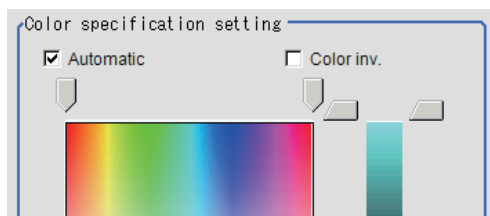

- 4** Finely adjust the hue, saturation, and brightness if necessary.
Adjust either by adjusting on the color chart or by inputting numbers.

Setting item	Setting value [Factory default]	Description
H	[0] to [359]	Sets the hue (difference in hue).
S	[0] to [255]	Sets the saturation (difference in saturation).
V	[0] to [255]	Sets the vividness (difference in vividness).
Automatic	<ul style="list-style-type: none"> • Checked • [Unchecked] 	Specifies the color to be measured on the image automatically sets the <i>hue</i> , <i>saturation</i> , and <i>brightness</i> .
Color inv.	<ul style="list-style-type: none"> • Checked • [Unchecked] 	Color other than the color specified is the measurement target.

- About color charts:

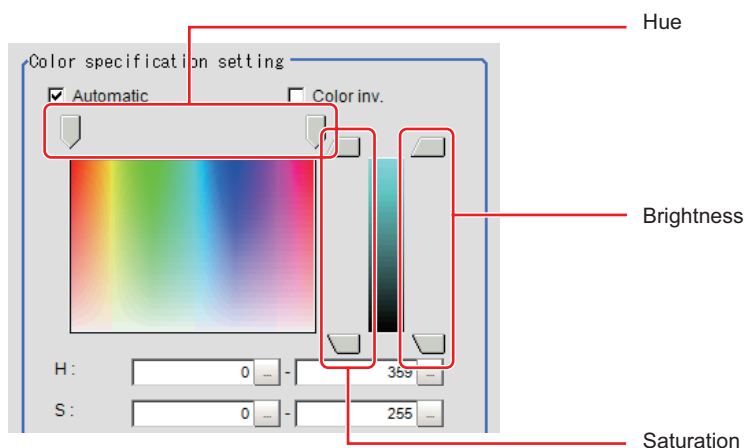

5 To specify multiple colors, place a check at **More ranges of color extraction**.

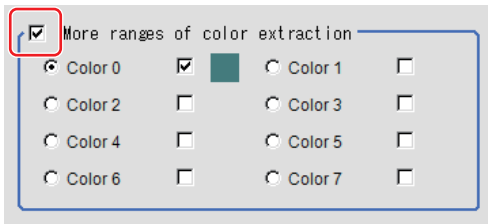

Setting item	Setting value [Factory default]	Description
More ranges of color extraction	<ul style="list-style-type: none"> • Checked • [Unchecked] 	Places a check at this allows you to set up to eight colors.

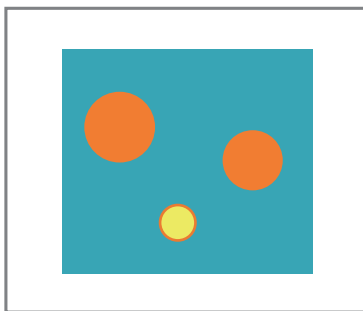

Extract image (before specifying colors)

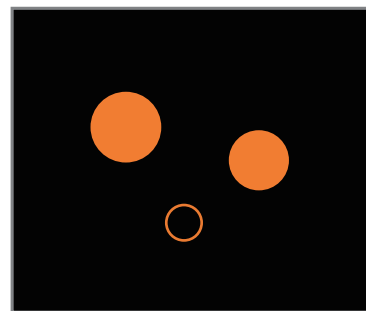

Extract image (after specifying colors – background color: black)

6 If necessary, set the display conditions for displayed images.

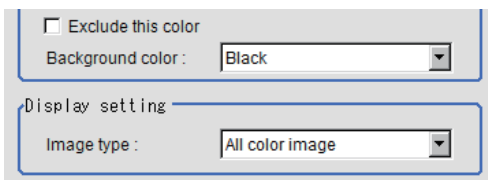

Setting item	Setting value [Factory default]	Description
Exclude this color	<ul style="list-style-type: none"> • Checked • [Unchecked] 	Places a check at this one excludes pixels within the set HSV range from color extraction. The priority order for the extraction is that the higher color extraction range numbers are given priority. This setting is disabled when <i>More ranges of color extraction</i> is unchecked.
Background color	<ul style="list-style-type: none"> • [Black] • White • Red • Green • Blue 	The background part other than the extraction image is filled with the specified colors.
Type of image	<ul style="list-style-type: none"> • Measurement image • [All color image] • color selected image • Binary image 	Sets the state of the image to display.

2-20-3 Binarization (Gravity and Area)

When a monochrome camera is connected, the 256-tone grayscale images taken in from the camera are converted into binary black-and-white images before the images are measured. Converted white pixels are measured.

This specifies the level for converting grayscale images into binary images.

- 1 In the Item Tab area, click **Binary**.
- 2 In the *Binary setting* area, specify the reference density range.

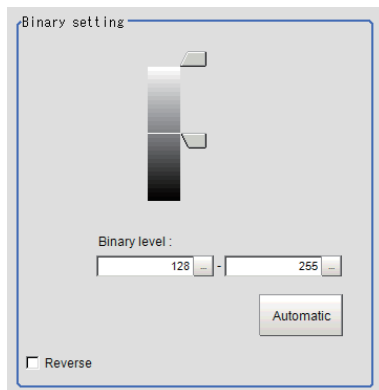

Setting item	Setting value [Factory default]	Description
Binary level	0 to 255 [128] to [255]	Sets a level to convert 256-gradation images to binary images. Set <i>Binary level</i> so that the measurement object becomes white pixels. A binary level for which measurement target is only middle density is also available.
Automatic	-	Optimum binary levels are calculated automatically and set.
Color inv.	<ul style="list-style-type: none"> • Checked • [Unchecked] 	Reverses black and white.

- 3 If necessary, in the *Display setting* area, set up display settings for the images displayed in the *Image Display* area.

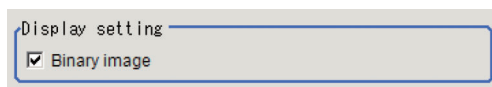

Setting item	Setting value [Factory default]	Description
Binary image	<ul style="list-style-type: none"> • [Checked] • Unchecked 	The image is displayed in binary with black and white.

2-20-4 Region Setting (Gravity and Area)

This item is used to set up the measurement area. It is possible to measure the entire input image, but restricting the range enables accurate measurement in a short period of time.

Use a rectangle, circle (ellipse), circumference, or polygon to specify a measurement region for **Gravity and Area**. Up to 8 figures can be combined to draw the measurement region.

- 1 In the Item tab area, click **Region setting**.
- 2 Click **OK** in the *Figure setting* area.
 - **OK**: Changes the settings and returns to the previous menu.
 - **Cancel**: Changes are discarded. Returns to the previous menu.
 - **Apply**: Updates the settings without leaving edit window.
- 3 If necessary, in the *Display setting* area, set up display settings for the images displayed in the *Image Display* area.

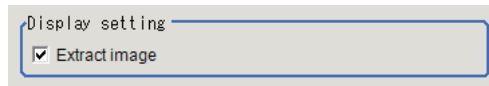

For color cameras:

Setting item	Setting value [Factory default]	Description
Extract image	<ul style="list-style-type: none"> • [Checked] • Unchecked 	If you place a check at this option, image set with the color specification are displayed.

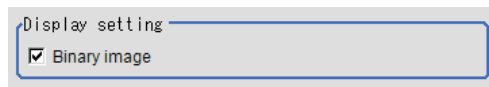

For monochrome cameras:

Setting item	Setting value [Factory default]	Description
Binary image	<ul style="list-style-type: none"> • [Checked] • Unchecked 	The image is displayed in binary with black and white.

2-20-5 Mask Setting (Gravity and Area)

Mask the measurement region when measuring it.

There are two types of masks, namely, a static mask that sets the mask region independent of measurement and a dynamic mask that uses images generated in another unit for each measurement

Creating a static mask

A static mask can be created manually or from an image of another unit.

- 1 In the *Mask setting* area, select *Static mask*.

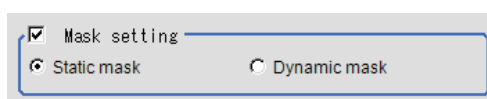

● Generating a mask manually

- 1 In the *Static mask set* area, select *Region extract*.

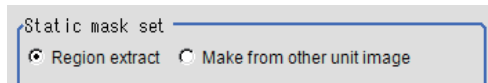

- 2 Select the selection region type OR or NOT and drag an image directly.
A region is created along successive similar colors from the selected place. It is not masked if the selection region type is OR.
It is masked if the selection region type is NOT.
To deselect a selected region, click **Undo**.
To edit a region selected with OR/NOT, click **Selected region edit**.

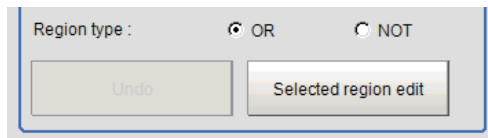

- 3 Adjust the mask created in the *Static mask setting* area.

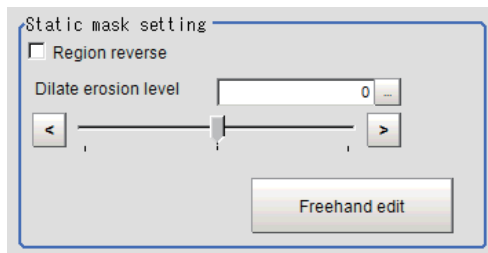

Setting item	Setting value [Factory default]	Description
Region reverse	<ul style="list-style-type: none"> • Checked • [Unchecked] 	Place a check to revert the created mask region.
Dilate erosion level	-10 to 10 [0]	Perform fine adjustment on the mask region using expansions/shrinkage. The region is expanded if a positive value is set. The region is shrunk if a negative value is set.

● Creating a static mask from an image of another unit

- 1 In the *Static mask set* area, select *Make from other unit image*.

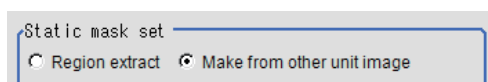

- 2 Set the unit number and image data number.

Unit No. : 1.Advanced filter

Image data No. : 0

Setting item	Setting value [Factory default]	Description
Unit No.	-	Specify the number of the unit whose image will be referenced. The reference unit should be able to output binarized images. For example, select a labeling filter processing image for advanced filtering.
Image data No.	0 to 3 [0]	If the unit supports advanced filtering, numbers 0 to 3 can be set. Otherwise, it is fixed to 0.

Performing fine adjustment on a static mask

- 1 To perform fine adjustment on a mask region, click **Freehand edit** in the *Static mask setting* area.

Freehand edit

Mask add Mask remove

Dot size: 1

Freehand edited contents will be deleted when mask is made again

Return

Setting item	Setting value [Factory default]	Description
Freehand edit	<ul style="list-style-type: none"> • [Mask add] • Mask remove 	Select a process performed using the free hand edit.
Dot size	1 to 20 [1]	Set the size of dots used when drawing images on the screen.

- 2 Click **Return** to exit the free hand edit.

Clearing the static mask setting

- 1 To clear the static mask setting, click **Clear**.

Creating a dynamic mask

- 1 In the *Mask setting* area, select *Dynamic mask*.

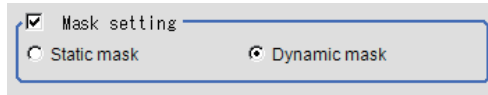

- 2 Set the unit number and image data number in the *Unit reference* area.

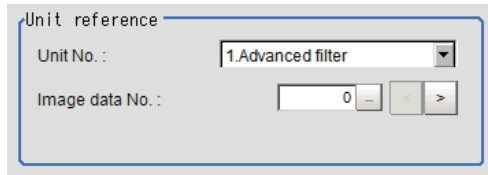

Setting item	Setting value [Factory default]	Description
Unit No.	-	Set the number of the unit being referred to for the mask region. The reference unit should be able to output binarized images. For example, select a labeling filter processing image for advanced filtering.
Image data No.	0 to 3 [0]	If the unit supports advanced filtering, numbers 0 to 3 can be set. Otherwise, it is fixed to 0.

Setting display

Perform the display setting if required.

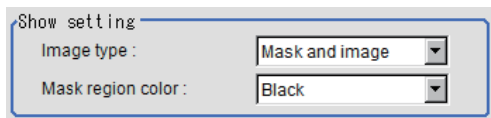

Setting item	Setting value [Factory default]	Description
Image type	<ul style="list-style-type: none"> Measure image Mask binary image [Mask and image] 	Select the type of an image to be displayed.
Mask region color	<ul style="list-style-type: none"> [Black] White Red Green Blue 	Select the display color of the mask region. A part of color which is specified in <i>Mask region color</i> is not measured.

2-20-6 Reference Setting (Gravity and Area)

When the measurement region is set, the center of gravity is automatically set at the same time as the reference position. This item is used to change the reference position to any desired position. This is handy for measuring the position deviation from a certain position. In the same way for the reference area, when the region settings are made, they are set automatically based on the measurement region.

A reference position can be set either directly or by referencing a unit.

Specifying directly

Click a position on the image you want to use as a reference position, or input coordinate data for that point.

- 1 In the Item tab area, click **Ref. setting**.
In the *Display* area, the current reference position will be displayed as the crosshair cursor.

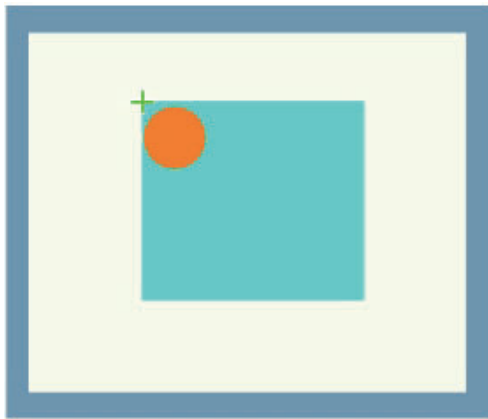

- 2 In the *Method* area, select *Numerical*.

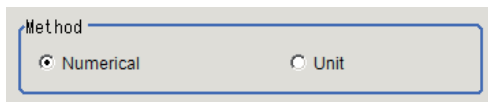

- 3 Click the position to be set as the reference.



Additional Information

Displaying the image enlarged makes this clicking easier.
For details, refer to *Appendixes Basic Knowledge about Operations Using the Zoom Function* in the *Vision System FH/FHV Series User's Manual* (Cat. No. Z365).

- 4 Make fine adjustments using numeric value inputs or the arrow buttons as required.

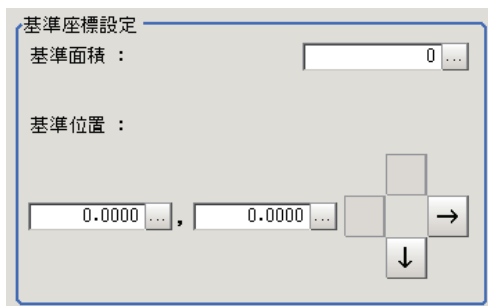

- 5 To remeasure on the displayed image and set the reference, click **Measure ref.**

To update the reference angle at the time of reference measurement, place a check at *Update the angle when measure ref.*

Update the angle when measure ref.

- 6** To use data before position compensation for the reference setting coordinates, place a check at *Use point coordinate before scroll.*

Reference coordinate

Position :
 ,

Angle :

Referencing a Unit

Set a reference by referencing a detection point unit with registered X coordinate, Y coordinate and angle data.

- 1** In the Item tab area, click **Ref. setting**.
In the *Display* area, the current reference position will be displayed as the crosshair cursor.
- 2** In the *Method* area, select *Unit*.

Method

Numerical Unit

- 3** In the *Unit* area, select a detection point unit in the scene.

Unit

Reference area :

Unit :

Performing the next measurement will display the reference.

2-20-7 Measurement Parameters (Gravity and Area)





This item specifies the judgement condition for measurement results. Specify the upper and lower limit values for the area and the gravity center X/Y.

Measurement parameters can be changed as needed to address unstable measurement results or to increase the processing speed. Normally, the factory default value will be used.

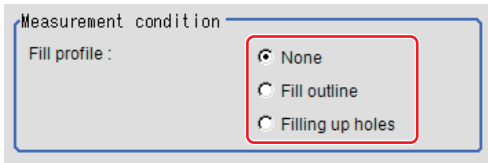
- 1** In the Item Tab area, click **Measurement**.

- 2** If necessary, in the *Measurement condition* area, select an option for *Fill profile*.
If the measurement target has holes in it, specify how to process the holes. Normally, the factory default value will be used.



Setting item	Setting value [Factory default]	Description
Fill profile	<ul style="list-style-type: none"> • [None] • Fill outline • Filling up holes 	<p>Selects the fill profile method.</p> <ul style="list-style-type: none"> • None The empty section in the center is not filled in. • Fill outline In the measurement region, the part between the extracted-color start point and end point in the X-axis direction is measured as having the extracted color. Since filling is applied only to the X-axis direction, the processing is faster than filling up holes. <div style="display: flex; justify-content: space-around; align-items: center;"> <div style="text-align: center;"> <p>Input image</p>  </div> <div style="text-align: center;"> <p>Image after filling up hole</p>  </div> </div> <ul style="list-style-type: none"> • Filling up holes The part surrounded by the extracted color, like a doughnut hole, is filled with the extracted color. <div style="display: flex; justify-content: space-around; align-items: center;"> <div style="text-align: center;"> <p>Input image</p>  </div> <div style="text-align: center;"> <p>Fill profile image</p>  </div> </div>

- 3** If necessary, in the *Display setting* area, set up display settings for the images displayed in the *Image Display* area.
- 4** When the setting has been changed, click **Measure** in the *Detail* area to verify whether measurements can be made correctly.

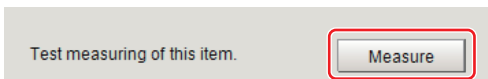

- 5** Set up the judgment condition.



Additional Information

The values beside each item are measurement results of the displayed image. Take these values into consideration to determine the upper and lower limit values.

Setting item	Setting value	Description
Area	0 to 999,999,999.9999	Specify the area to be judged as OK.
Gravity X	-99,999.9999 to 99,999.9999	Specify the range of X-axis shifting that is judged to be OK.
Gravity Y	-99,999.9999 to 99,999.9999	Specify the range of Y-axis shifting that is judged to be OK.

2-20-8 Output Parameters (Gravity and Area)

Specify how to treat the coordinates to be output to the external device as measurement results. This item can be changed if necessary. Normally, the factory default value will be used.



Precautions for Correct Use

After setting up the measurement parameters, changing the output parameters will cause measurement results to vary accordingly. If the output parameters have been changed, re-specify the measurement, too.

- 1 Click **Output parameter** in the Item tab area.
- 2 Specify each of the following items.

Setting item	Setting value [Factory default]	Description
Output coordinates	<ul style="list-style-type: none"> • [After scroll] • Before scroll 	As measurement results, select whether to output coordinate values to external devices before or after the position deflection correction is applied.
Calibration	<ul style="list-style-type: none"> • ON • [OFF] 	Select whether to reflect the calibration in the values output to the external device as measurement results. <ul style="list-style-type: none"> • ON: Output the coordinates converted into actual dimensions. • OFF: Output the camera coordinate values.
Reflect to overall judgment	<ul style="list-style-type: none"> • [ON] • OFF 	Enables choosing whether or not the judgement results of this processing unit is reflected in the scene overall judgment.



Additional Information

For output coordinates and calibration, refer to *Appendixes Measurement Mechanism Handling Coordinates* in the *Vision System FH/FHV Series User's Manual (Cat. No. Z365)*.

2-20-9 Key Points for Test Measurement and Adjustment (Gravity and Area)

The following content is displayed in the *Detail result* area as text.

Displayed item	Description
Judge	Judgment results 0: No judgment (unmeasured) 1: Judgment result OK -1: Judgment result NG -10: Error (image format mismatch) -11: Error (unregistered model) -12: Error (insufficient memory) -20: Error (other errors)
Area	Area
Gravity X	Gravity X coordinate
Gravity Y	Gravity Y coordinate

The image specified in the Sub-image number in the image display setting is displayed in the *Image Display* area.

Sub-image number	Description of image to be displayed
0	Measurement image
1	Extracted image

Key Points for Adjustment (Gravity and Area)

Adjust the setting parameters referring to the following points.

● When the measurement results are unstable (for color cameras)

Parameter to be adjusted	Remedy
Color	Click the area whose color will be sampled and the area whose color will not be sampled. The setup should be such that two stable sections of hue, saturation and brightness are formed.

● When the measurement results are unstable (for monochrome cameras)

Parameter to be adjusted	Remedy
Color	Adjust the <i>Binary level</i> .

2-20-10 Measurement Results for Which Output Is Possible (Gravity and Area)

The following values can be output using processing items related to result output. It is also possible to reference measurement values from calculation expressions and other processing units.

Measurement items	Character string	Description
Judge	JG	Judgment results 0: No judgment (unmeasured) 1: Judgment result OK -1: Judgment result NG -10: Error (image format mismatch) -11: Error (unregistered model) -12: Error (insufficient memory) -20: Error (other errors)
Area	AR	Area
Gravity X	X	Gravity X coordinate
Gravity Y	Y	Gravity Y coordinate
Ref. area	SA	Reference for the area
Ref. coordinate X	SX	X coordinate of the reference position
Ref. coordinate Y	SY	Y coordinate of the reference position

2-20-11 External Reference Tables (Gravity and Area)

No.	Data name	Data ident	Set/Get	Data range
0	Judge	judge	Get only	0: No judgment (unmeasured), 1: Judgment result OK, -1: Judgment result NG, -10: Error (image format mismatch), -11: Error (unregistered model), -12: Error (insufficient memory), -20: Error (other errors)
5	Area	area	Get only	0 to 999,999,999.9999
6	Gravity X	gravityX	Get only	-99,999.9999 to 99,999.9999
7	Gravity Y	gravityY	Get only	-99,999.9999 to 99,999.9999
8	Reference area	referenceAreaMS	Get only	0 to 999,999,999
9	Reference X	referenceX	Get only	-99,999.9999 to 99,999.9999
10	Reference Y	referenceY	Get only	-99,999.9999 to 99,999.9999
101	Output coordinates	outputCoordinate	Set/Get	0: After scroll, 1: Before scroll
102	Calibration	calibration	Set/Get	0: OFF, 1: ON
103	Reflect to overall judgement	overallJudge	Set/Get	0: ON, 1: OFF
126	Extract image	extractImage	Set/Get	0: OFF, 1: ON
128	Fill profile	edgeFill	Set/Get	0: OFF, 1: Fill profile, 2: Filling up holes
129	Color inv.(reverse for monochrome)	areaInv	Set/Get	0: OFF, 1: ON
132	Reference area	referenceArea	Set/Get	0 to 999,999,999
133	Reference X	referencePosX	Set/Get	0 to 99,999.9999
134	Reference Y	referencePosY	Set/Get	0 to 99,999.9999
135	Upper limit of the area	upperArea	Set/Get	0 to 999,999,999.9999
136	Lower limit of the area	lowerArea	Set/Get	0 to 999,999,999.9999

No.	Data name	Data ident	Set/Get	Data range
137	Upper limit of gravity X	upperGravityX	Set/Get	-99,999.9999 to 99,999.9999
138	Lower limit of gravity X	lowerGravityX	Set/Get	-99,999.9999 to 99,999.9999
139	Upper limit of gravity Y	upperGravityY	Set/Get	-99,999.9999 to 99,999.9999
140	Lower limit of gravity Y	lowerGravityY	Set/Get	-99,999.9999 to 99,999.9999
141	Upper limit of the binary level	upperBinary	Set/Get	0 to 255
142	Lower limit of the binary level	lowerBinary	Set/Get	0 to 255
143	Binary image	binaryImage	Set/Get	0: OFF, 1: ON
144	Image kind	imageKind	Set/Get	0: Measurement image, 1: All color image, 2: Selection color image, 3: Binary image
145	Multiple selections	multiSelect	Set/Get	0: Multiple selections disabled, 1: Multiple selections enabled
160+N×10 (N=0 to 7)	Flag used for registered color	flag0 to flag7	Set/Get	0:Not used 1:Used
161+N×10 (N=0 to 7)	Flag for registered color OR/NOT	orNot0 to orNot7	Set/Get	0: OR, 1: NOT
162+N×10 (N=0 to 7)	Register the max. color hue	upperH0 to upperH7	Set/Get	0 to 359
163+N×10 (N=0 to 7)	Register the min. color hue	lowerH0 to lowerH7	Set/Get	0 to 359
164+N×10 (N=0 to 7)	Register the max. color saturation	upperS0 to upperS7	Set/Get	0 to 255
165+N×10 (N=0 to 7)	Register the min. color saturation	lowerS0 to lowerS7	Set/Get	0 to 255
166+N×10 (N=0 to 7)	Register the max. color brightness	upperV0 to upperV7	Set/Get	0 to 255
167+N×10 (N=0 to 7)	Register the min. color brightness	lowerV0 to lowerV7	Set/Get	0 to 255
168+N×10 (N=0 to 7)	Background color	background0 to background7	Set/Get	0: Black, 1: White, 2: Red, 3: Green, 4: Blue
301	Setting unit of reference coordinate	refUnitNo	Set/Get	-1 to 9,999
302	Setting type of reference coordinate	refSettingType	Set/Get	0: Numerical, 1: Unit
303	Use point coordinate before scroll	beforeScrollRefMode	Set/Get	0: Not use, 1: Use
304	Reference X before scroll	beforeScrollRefPosX	Set/Get	-99,999.9999 to 99,999.9999
305	Reference Y before scroll	beforeScrollRefPosY	Set/Get	-99,999.9999 to 99,999.9999
316	Dynamic mask unit reference no	DynUnitNo	Set/Get	-1 to 9,999
317	Dynamic mask image no	DynImageNo	Set/Get	0 to 99

No.	Data name	Data ident	Set/Get	Data range
319	Display image type	ChkChoose	Set/Get	0: Measure image, 1: Mask binary image, 2: Mask and image
325	Mask region display color	maskRegionColor	Set/Get	0: Black, 1: White, 2: Red, 3: Green, 4: Blue
6,002	Format	cameraColor	Set/Get	1: Monochrome camera 2: Color camera
90,000	Inspection area figure Count	figArea0_count	Set/Get	0 to 8
90,001	Inspection area figure0 Type	figArea0_fig0_type	Set/Get	8: Rectangle, 16: Ellipse, 64: Circumference, 512: Polygon
90,002	Inspection area figure0 mode	figArea0_fig0_mode	Set/Get	0: OR, 1: NOT
90,014	Inspection area figure0 Rectangle Upper left position X	figArea0_fig0_box_X0	Set/Get	-99,999 to 99,999
90,015	Inspection area figure0 Rectangle Upper left position Y	figArea0_fig0_box_Y0	Set/Get	-99,999 to 99,999
90,016	Inspection area figure0 Rectangle Lower right position X	figArea0_fig0_box_X1	Set/Get	-99,999 to 99,999
90,017	Inspection area figure0 Rectangle Lower right position Y	figArea0_fig0_box_Y1	Set/Get	-99,999 to 99,999
90,018	Inspection area figure0 Ellipse Center Position X	figArea0_fig0_ellipse_CX	Set/Get	-99,999 to 99,999
90,019	Inspection area figure0 Ellipse Center Position Y	figArea0_fig0_ellipse_CY	Set/Get	-99,999 to 99,999
90,020	Inspection area figure0 Ellipse RadiusX	figArea0_fig0_ellipse_RX	Set/Get	1 to 99,999
90,021	Inspection area figure0 Ellipse RadiusY	figArea0_fig0_ellipse_RY	Set/Get	1 to 99,999
90,025	Inspection area figure0 Circumference Center Position X	figArea0_fig0_circleW_X	Set/Get	-99,999 to 99,999
90,026	Inspection area figure0 Circumference Center Position Y	figArea0_fig0_circleW_Y	Set/Get	-99,999 to 99,999
90,027	Inspection area figure0 Circumference Radius	figArea0_fig0_circleW_R	Set/Get	0 to 99,999
90,028	Inspection area figure0 Circumference Width	figArea0_fig0_circleW_W	Set/Get	0 to 99,999
90,040	Inspection area figure0 Polygon Point Count	figArea0_fig0_polygon_count	Set/Get	3 to 10

No.	Data name	Data ident	Set/Get	Data range
90,041	Inspection area figure0 Polygon Point1 Position X	figArea0_fig0_polygon_x0	Set/Get	-99,999 to 99,999
90,042	Inspection area figure0 Polygon Point1 Position Y	figArea0_fig0_polygon_y0	Set/Get	-99,999 to 99,999
:	:	:	:	:
90,059	Inspection area figure0 Polygon Point10 Position X	figArea0_fig0_polygon_x9	Set/Get	-99,999 to 99,999
90,060	Inspection area figure0 Polygon Point10 Position Y	figArea0_fig0_polygon_y9	Set/Get	-99,999 to 99,999
90,099	Inspection area figure Update	figArea0_update	Set only	1: Update
90,101	Inspection area figure1 Type	figArea0_fig1_type	Set/Get	8: Rectangle, 16: Ellipse, 64: Circumference, 512: Polygon
:	:	:	:	:
90,201	Inspection area figure2 Type	figArea0_fig2_type	Set/Get	8: Rectangle, 16: Ellipse, 64: Circumference, 512: Polygon
:	:	:	:	:
90,301	Inspection area figure3 Type	figArea0_fig3_type	Set/Get	8: Rectangle, 16: Ellipse, 64: Circumference, 512: Polygon
:	:	:	:	:
90,401	Inspection area figure4 Type	figArea0_fig4_type	Set/Get	8: Rectangle, 16: Ellipse, 64: Circumference, 512: Polygon
:	:	:	:	:
90,501	Inspection area figure5 Type	figArea0_fig5_type	Set/Get	8: Rectangle, 16: Ellipse, 64: Circumference, 512: Polygon
:	:	:	:	:
90,601	Inspection area figure6 Type	figArea0_fig6_type	Set/Get	8: Rectangle, 16: Ellipse, 64: Circumference, 512: Polygon
:	:	:	:	:
90,701	Inspection area figure7 Type	figArea0_fig7_type	Set/Get	8: Rectangle, 16: Ellipse, 64: Circumference, 512: Polygon
:	:	:	:	:
91,000	Mask area figure Count	figArea1_count	Set/Get	1
91,001	Mask area figure0 Type	figArea1_fig0_type	Set/Get	8: Rectangle
91,002	Mask area figure0 mode	figArea1_fig0_mode	Set/Get	0: OR
91,014	Mask area figure0 Rectangle Upper left position X	figArea1_fig0_box_X0	Set/Get	-99,999 to 99,999
91,015	Mask area figure0 Rectangle Upper left position Y	figArea1_fig0_box_Y0	Set/Get	-99,999 to 99,999

No.	Data name	Data ident	Set/Get	Data range
91,016	Mask area figure0 Rectangle Lower right position X	figAr- ea1_fig0_box_X1	Set/Get	-99,999 to 99,999
91,017	Mask area figure0 Rectangle Lower right position Y	figAr- ea1_fig0_box_Y1	Set/Get	-99,999 to 99,999
91,099	Mask area figure Up- date	figArea1_update	Set only	1: Update
92,000	Selected area figure Count	figArea2_count	Set/Get	0 to 8
92,001	Selected area fig- ure0 Type	figArea2_fig0_type	Set/Get	8: Rectangle
92,002	Selected area fig- ure0 mode	figArea2_fig0_mode	Set/Get	0: OR, 1: NOT
92,014	Selected area fig- ure0 Rectangle Up- per left position X	figAr- ea2_fig0_box_X0	Set/Get	-99,999 to 99,999
92,015	Selected area fig- ure0 Rectangle Up- per left position Y	figAr- ea2_fig0_box_Y0	Set/Get	-99,999 to 99,999
92,016	Selected area fig- ure0 Rectangle Low- er right position X	figAr- ea2_fig0_box_X1	Set/Get	-99,999 to 99,999
92,017	Selected area fig- ure0 Rectangle Low- er right position Y	figAr- ea2_fig0_box_Y1	Set/Get	-99,999 to 99,999
92,099	Selected area figure Update	figArea2_update	Set only	1: Update
92,101	Selected area fig- ure1 Type	figArea2_fig1_type	Set/Get	8: Rectangle
:	:	:	:	:
92,201	Selected area fig- ure2 Type	figArea2_fig2_type	Set/Get	8: Rectangle
:	:	:	:	:
92,301	Selected area fig- ure3 Type	figArea2_fig3_type	Set/Get	8: Rectangle
:	:	:	:	:
92,401	Selected area fig- ure4 Type	figArea2_fig4_type	Set/Get	8: Rectangle
:	:	:	:	:
92,501	Selected area fig- ure5 Type	figArea2_fig5_type	Set/Get	8: Rectangle
:	:	:	:	:
92,601	Selected area fig- ure6 Type	figArea2_fig6_type	Set/Get	8: Rectangle
:	:	:	:	:
92,701	Selected area fig- ure7 Type	figArea2_fig7_type	Set/Get	8: Rectangle
:	:	:	:	:

No.	Data name	Data ident	Set/Get	Data range
92,717	Selected area figure7 Rectangle Lower right position Y	figAr- ea2_fig7_box_Y1	Set/Get	-99,999 to 99,999

2-21 Labeling

You can count the number of labels with a specified color or find the area and center of gravity of a specified label number.

Used in the Following Case

Label count inspection:

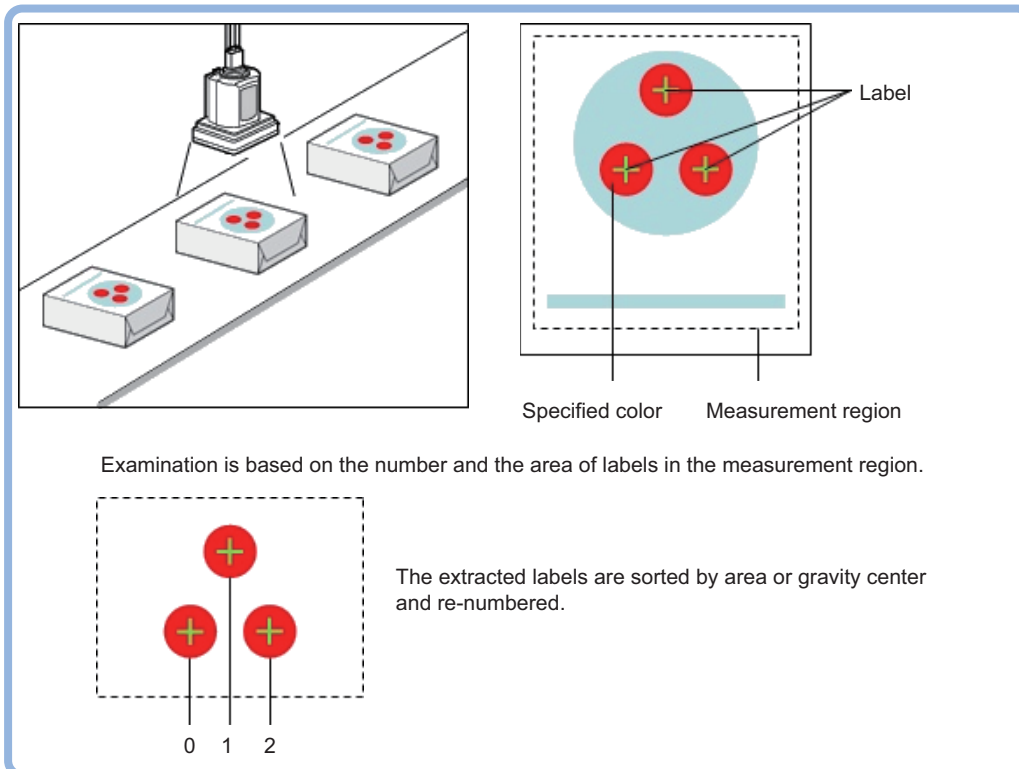

Precautions for Correct Use

Processing is different for color images and monochrome images. When the camera type used in the previous setup was changed to color or monochrome type, perform the settings again.

2-21-1 Settings Flow (Labeling)

To set Labeling, follow the steps below.

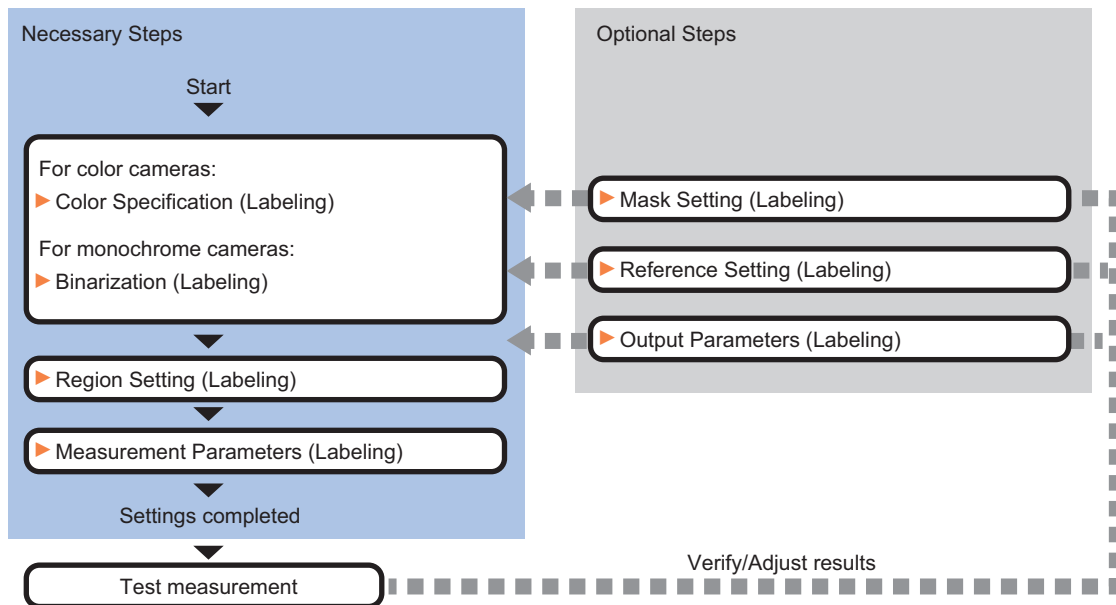

List of Labeling Items

Item	Description
Color (for color cameras only)	This item selects the color whose area and center of gravity are to be measured. Since the color hue, color saturation, and brightness can be selected, then fine-tuning can be performed to colors. <i>2-21-2 Color Specification (Labeling) on page 2-319</i>
Binary (for monochrome cameras only)	This item specifies the binary level for converting 256-tone grayscale images input from the camera into binary images. Converted white pixels are measured. Adjust the binary level so that the measurement object is converted to white pixels. <i>2-21-3 Binarization (Labeling) on page 2-321</i>
Region setting	Sets the measurement area. It is possible to target the entire screen, but restricting the range can shorten the processing time. <i>2-21-4 Region Setting (Labeling) on page 2-322</i>
Mask setting	Set it when masking a region. The measurement result of another processing item can also be used for masking. <i>2-21-5 Mask Setting (Labeling) on page 2-323</i>
Ref. setting	This item can be changed as necessary. Specify the reference position within the camera's field of view. <i>2-21-6 Reference Setting (Labeling) on page 2-326</i>
Measurement parameter	Sets processing conditions for measurement and judgment conditions for measurement results. It specifies the upper and lower limit values for the number of labels, the area and the center of gravity X and Y. Measurement parameter can be changed as needed to address unstable measurement results. Normally, the factory default value will be used. <i>2-21-7 Measurement Parameters (Labeling) on page 2-328</i>

Item	Description
Output parameter	This item can be changed as necessary. Normally, the factory default value will be used. Use the output parameter to specify how to handle the coordinates. <i>2-21-9 Output Parameters (Labeling)</i> on page 2-332

2-21-2 Color Specification (Labeling)

When connecting a color camera, specify the color to be measured. There are two specification methods: specifying the color to be extracted in the image or specifying the color with the hue, saturation, and brightness values.

This section describes how to specify colors in an image and gives an example of the procedure for finely adjusting with numeric input afterwards.

- 1** In the Item Tab area, click **Color**.
- 2** Place a check at **Automatic**.
- 3** In the *Image Display* area, specify the color range you want to detect by dragging the cursor from the upper left corner to the lower right corner of that area.
The color of the specified area is automatically set.

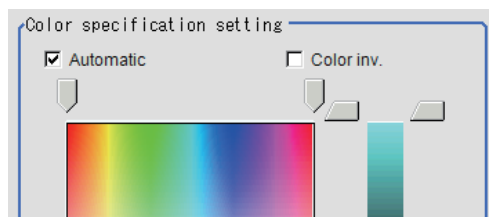

- 4** Finely adjust the hue, saturation, and brightness if necessary.
Adjust either by adjusting on the color chart or by inputting numbers.

Setting item	Setting value [Factory default]	Description
H	[0] to [359]	Sets the hue (difference in hue).
S	[0] to [255]	Sets the saturation (difference in saturation).
V	[0] to [255]	Sets the vividness (difference in vividness).
Automatic	<ul style="list-style-type: none"> • Checked • [Unchecked] 	Specifies the color to be measured on the image automatically sets the <i>hue</i> , <i>saturation</i> , and <i>brightness</i> .
Color inv.	<ul style="list-style-type: none"> • Checked • [Unchecked] 	Color other than the color specified is the measurement target.

- About color charts:

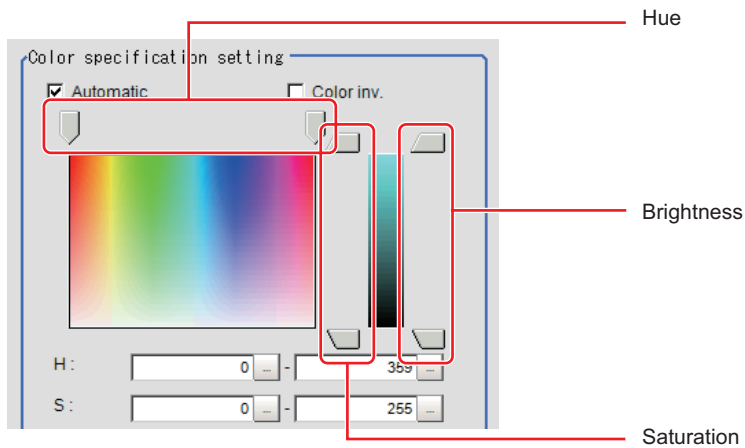

5 To specify multiple colors, place a check at **More ranges of color extraction**.

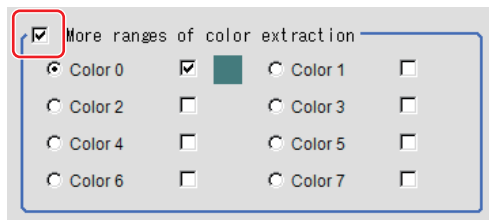

Setting item	Setting value [Factory default]	Description
More ranges of color extraction	<ul style="list-style-type: none"> • Checked • [Unchecked] 	Places a check at this allows you to set up to eight colors.

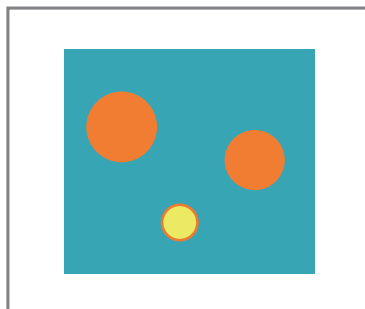

Extract image (before specifying colors)

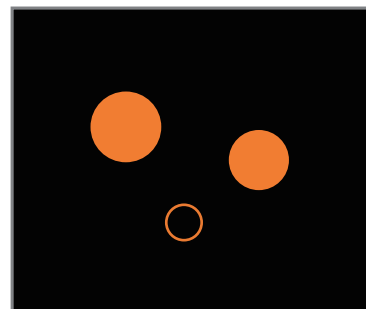

Extract image (after specifying colors – background color: black)

6 If necessary, set the display conditions for displayed images.

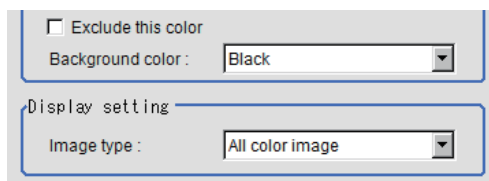

Setting item	Setting value [Factory default]	Description
Exclude this color	<ul style="list-style-type: none"> • Checked • [Unchecked] 	Places a check at this one excludes pixels within the set HSV range from color extraction. The priority order for the extraction is that the higher color extraction range numbers are given priority. This setting is disabled when <i>More ranges of color extraction</i> is unchecked.
Background color	<ul style="list-style-type: none"> • [Black] • White • Red • Green • Blue 	The background part other than the extraction image is filled with the specified colors.
Type of image	<ul style="list-style-type: none"> • Measurement image • [All color image] • color selected image • Binary image 	Sets the state of the image to display.

2-21-3 Binarization (Labeling)

When a monochrome camera is connected, the 256-tone grayscale images taken in from the camera are converted into binary black-and-white images before the images are measured. Converted white pixels are measured.

This specifies the level for converting grayscale images into binary images.

- 1 In the Item Tab area, click **Binary**.
- 2 In the *Binary setting* area, specify the reference density range.

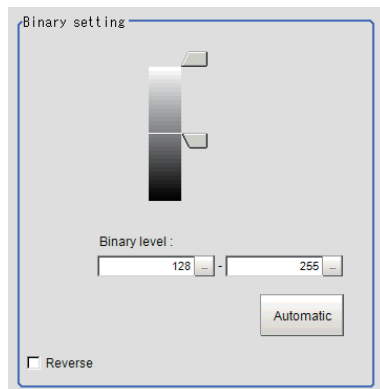

Setting item	Setting value [Factory default]	Description
Binary level	0 to 255 [128] to [255]	Sets a level to convert 256-gradation images to binary images. Set <i>Binary level</i> so that the measurement object becomes white pixels. A binary level for which measurement target is only middle density is also available.
Automatic	-	Optimum binary levels are calculated automatically and set.
Color inv.	<ul style="list-style-type: none"> • Checked • [Unchecked] 	Reverses black and white.

- 3** If necessary, in the *Display setting* area, set up display settings for the images displayed in the *Image Display* area.

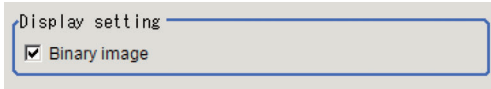

Setting item	Setting value [Factory default]	Description
Binary image	<ul style="list-style-type: none"> • [Checked] • Unchecked 	The image is displayed in binary with black and white.

2-21-4 Region Setting (Labeling)

This item is used to set up the measurement area. It is possible to measure the entire input image, but restricting the range enables accurate measurement in a short period of time.

Use a rectangle, straight line, circle (ellipse), circumference, arc, wide arc, or polygon to specify a measurement region for **Labeling**. Up to 8 figures can be combined to draw the measurement region.

- 1** In the Item tab area, click **Region setting**.
- 2** Click **OK** in the *Figure setting* area.
 - **OK**: Changes the settings and returns to the previous menu.
 - **Cancel**: Changes are discarded. Returns to the previous menu.
 - **Apply**: Updates the settings without leaving edit window.
- 3** If necessary, in the *Display setting* area, set up display settings for the images displayed in the *Image Display* area.



For color cameras:

Setting item	Setting value [Factory default]	Description
Extract image	<ul style="list-style-type: none"> • [Checked] • Unchecked 	If you place a check at this option, image set with the color specification are displayed.

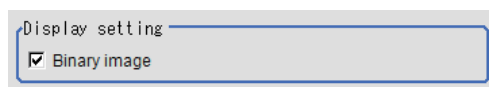

For monochrome cameras:

Setting item	Setting value [Factory default]	Description
Binary image	<ul style="list-style-type: none"> • [Checked] • Unchecked 	The image is displayed in binary with black and white.

2-21-5 Mask Setting (Labeling)

Mask the measurement region when measuring it.

There are two types of masks, namely, a static mask that sets the mask region independent of measurement and a dynamic mask that uses images generated in another unit for each measurement

Creating a static mask

A static mask can be created manually or from an image of another unit.

- 1 In the *Mask setting* area, select *Static mask*.

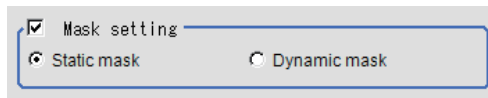

● Generating a mask manually

- 1 In the *Static mask set* area, select *Region extract*.

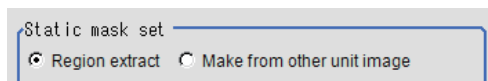

- 2 Select the selection region type OR or NOT and drag an image directly.
A region is created along successive similar colors from the selected place. It is not masked if the selection region type is OR.
It is masked if the selection region type is NOT.
To deselect a selected region, click **Undo**.
To edit a region selected with OR/NOT, click **Selected region edit**.

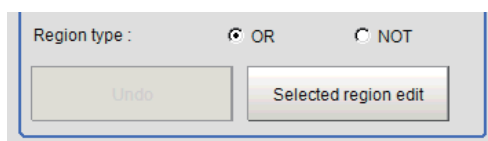

- 3 Adjust the mask created in the *Static mask setting* area.

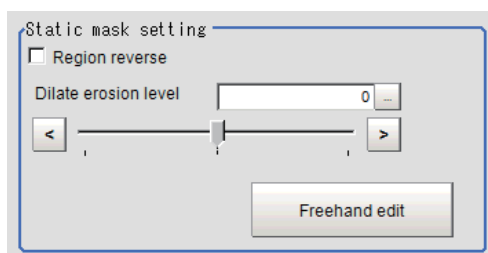

Setting item	Setting value [Factory default]	Description
Region reverse	<ul style="list-style-type: none"> • Checked • [Unchecked] 	Place a check to revert the created mask region.
Dilate erosion level	-10 to 10 [0]	Perform fine adjustment on the mask region using expansions/shrinkage. The region is expanded if a positive value is set. The region is shrunk if a negative value is set.

● Creating a static mask from an image of another unit

- 1 In the *Static mask set* area, select *Make from other unit image*.

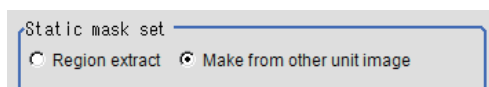

- 2 Set the unit number and image data number.

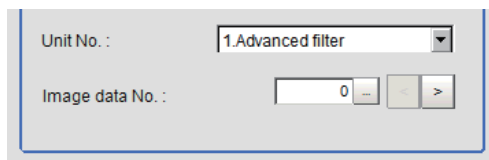

Setting item	Setting value [Factory default]	Description
Unit No.	-	Specify the number of the unit whose image will be referenced. The reference unit should be able to output binarized images. For example, select a labeling filter processing image for advanced filtering.
Image data No.	0 to 3 [0]	If the unit supports advanced filtering, numbers 0 to 3 can be set. Otherwise, it is fixed to 0.

Performing fine adjustment on a static mask

- 1 To perform fine adjustment on a mask region, click **Freehand edit** in the *Static mask setting* area.

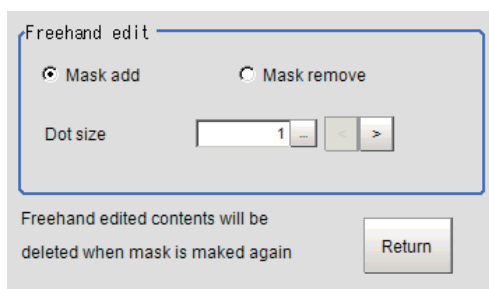

Setting item	Setting value [Factory default]	Description
Freehand edit	<ul style="list-style-type: none"> [Mask add] Mask remove 	Select a process performed using the free hand edit.
Dot size	1 to 20 [1]	Set the size of dots used when drawing images on the screen.

- 2 Click **Return** to exit the free hand edit.

Clearing the static mask setting

- 1 To clear the static mask setting, click **Clear**.

Creating a dynamic mask

- 1 In the *Mask setting* area, select *Dynamic mask*.

- 2 Set the unit number and image data number in the *Unit reference* area.

Setting item	Setting value [Factory default]	Description
Unit No.	-	Set the number of the unit being referred to for the mask region. The reference unit should be able to output binarized images. For example, select a labeling filter processing image for advanced filtering.
Image data No.	0 to 3 [0]	If the unit supports advanced filtering, numbers 0 to 3 can be set. Otherwise, it is fixed to 0.

Setting display

Perform the display setting if required.

Setting item	Setting value [Factory default]	Description
Image type	<ul style="list-style-type: none"> • Measure image • Mask binary image • [Mask and image] 	Select the type of an image to be displayed.
Mask region color	<ul style="list-style-type: none"> • [Black] • White • Red • Green • Blue 	Select the display color of the mask region. A part of color which is specified in <i>Mask region color</i> is not measured.

2-21-6 Reference Setting (Labeling)

When the measurement region is set, the center of gravity is automatically set at the same time as the reference position. This item is used to change the reference position to any desired position. This is handy for measuring the position deviation from a certain position. In the same way for the reference area, when the region settings are made, they are set automatically based on the measurement region.

A reference position can be set either directly or by referencing a unit.

Specifying directly

Click a position on the image you want to use as a reference position, or input coordinate data for that point.

- 1 In the Item tab area, click **Ref. setting**.
In the *Display* area, the current reference position will be displayed as the crosshair cursor.

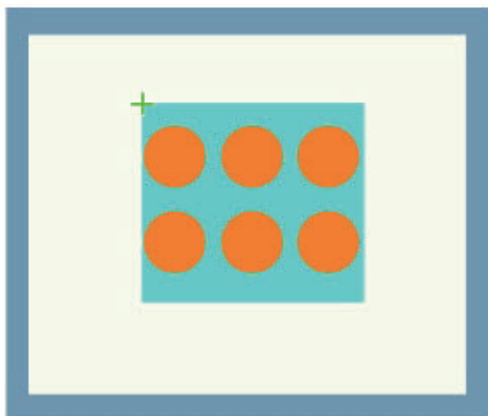

- 2 In the *Method* area, select *Numerical*.



- 3 Click the position to be set as the reference.



Additional Information

Displaying the image enlarged makes this clicking easier.

For details, refer to *Appendixes Basic Knowledge about Operations Using the Zoom Function in the Vision System FH/FHV Series User's Manual (Cat. No. Z365)*.

- 4** Make fine adjustments using numeric value inputs or the arrow buttons as required.

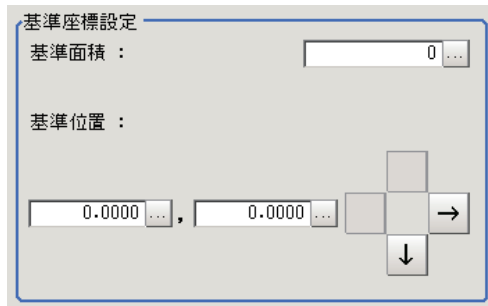

- 5** To remeasure on the displayed image and set the reference, click **Measure ref.**.
To update the reference angle at the time of reference measurement, place a check at *Update the angle when measure ref.* .

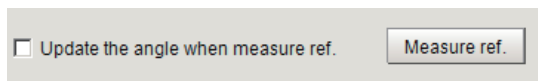

- 6** To use data before position compensation for the reference setting coordinates, place a check at *Use point coordinate before scroll.*

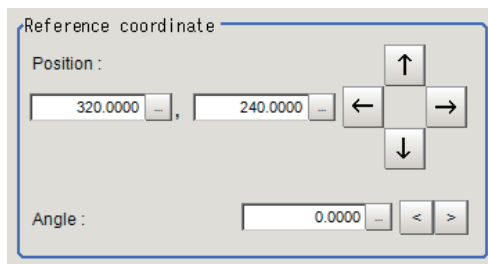

Referencing a Unit

Set a reference by referencing a detection point unit with registered X coordinate, Y coordinate and angle data.

- 1** In the Item tab area, click **Ref. setting**.
In the *Display* area, the current reference position will be displayed as the crosshair cursor.
- 2** In the *Method* area, select *Unit*.

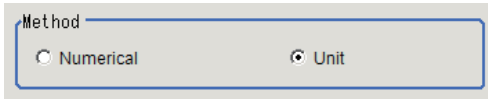

- 3 In the *Unit* area, select a detection point unit in the scene.

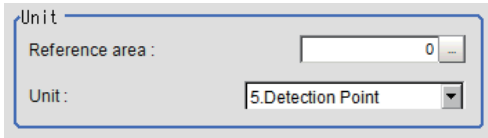

Performing the next measurement will display the reference.

2-21-7 Measurement Parameters (Labeling)

This item specifies the judgement condition for measurement results.

Measurement parameters can be changed as needed to address unstable measurement results or to increase the processing speed. Normally, the factory default value will be used.

- 1 In the Item tab area, click **Measurement**.
- 2 If necessary, in the *Labeling condition* area, specify a value for each item.

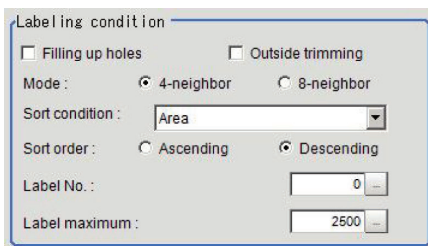

Setting item	Setting value [Factory default]	Description
Filling up holes	<ul style="list-style-type: none"> • Checked • [Unchecked] 	<p>Selects the processing method for a part surrounded by the specified color like a donut. Selecting <i>Checked</i> processes the part as having the specified color.</p> <p>Input image Fill profile image</p>

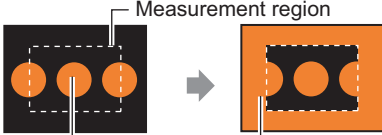
Setting item	Setting value [Factory default]	Description
Outside trimming	<ul style="list-style-type: none"> • Checked • [Unchecked] 	<p>Selects this when there is a color part not to be measured in the measurement region.</p> <p>When <i>Checked</i> is selected, the whole area outside of the measurement region is extracted as having the specified color.</p> <div style="text-align: center;">  </div> <p>When calculating the position and area of this label</p> <p>The area outside of the measurement region turns into the color of the measurement target. Sort mode: Area descending Label No.: 1 With the settings above, the position and area of the middle label will be measured.</p>
Mode	<ul style="list-style-type: none"> • [Cross] • Square 	<p>Specifies the connection conditions for labeling.</p> <ul style="list-style-type: none"> • Cross Processes contiguous parts up, down, left, and right of the target pixel as the same label. • Square Add oblique directions to the <i>Cross</i> processing.
Sort condition	<ul style="list-style-type: none"> • [Area] • X • Y • Elliptic major axis • Elliptic minor axis • Elliptic ratio • Rectangle width • Rectangle height • Rectangle X1 • Rectangle Y1 • Perimeter • Circularity • Fit rect major axis • Fit rect minor axis • Fit rect ratio • Inscribed circle X • Inscribed circle Y • Inscribed circle R • Circum. circle X • Circum. circle Y • Circum. circle R • Number of holes 	<p>Specifies the conditions by which label number is re-assigned.</p> <p>When sorting referencing the X and Y coordinates, the upper left is the origin.</p>

Setting item	Setting value [Factory default]	Description
Sort order	<ul style="list-style-type: none"> Ascending [Descending] 	Sets the direction for sorting. <ul style="list-style-type: none"> Ascending: Numbers are assigned from smaller values to larger. Descending: Numbers are assigned from larger values to smaller.
Label No.	0 to 9,998 [0]	Set the label number for the data to be output.
Label maximum	1 to 9,999 [2,500]	Sets the maximum number of labels to be output. If either one of the following conditions is satisfied, the maximum figure is limited due to the processing time and memory consumption. <ul style="list-style-type: none"> The region size is bigger than approx. 12 M pixels (4,096 x 3,072). The region size is bigger than 5 M pixels (2,448 x 2,044) and "Filling up holes" item is selected. This limitation is applied to the following models. <ul style="list-style-type: none"> FH-L550 FH-2000/FH-5000 Series

3 If necessary, in the *Display setting* area, set up display settings for the images displayed in the *Image Display* area.



Setting item	Setting value [Factory default]	Description
Binary image	<ul style="list-style-type: none"> [Checked] Unchecked 	The image is displayed in binary with black and white.

4 Set the *Extraction condition*.

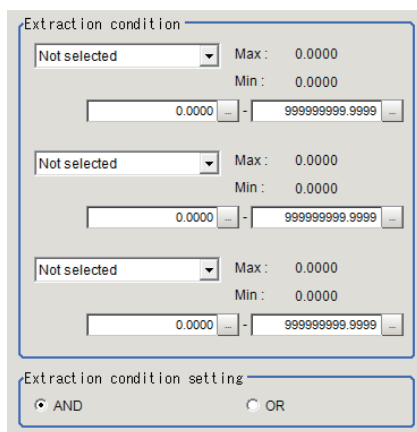

Setting item	Setting value [Factory default]	Description
Extraction condition	<ul style="list-style-type: none"> • [Not selected] • Area • Gravity X • Gravity Y • Elliptic major axis • Elliptic minor axis • Elliptic ratio • Rectangle width • Rectangle height • Rectangle X1 • Rectangle Y1 • Perimeter • Circularity • Fit rect major axis • Fit rect minor axis • Inscribed circle R • Circum. circle R • Number of holes 	Sets the extraction conditions.
Extraction condition setting	<ul style="list-style-type: none"> • [AND] • OR 	Selects the condition for <i>Extraction condition</i> . <ul style="list-style-type: none"> • AND: Labels meeting all conditions set in <i>Extraction condition</i>. • OR: Labels meeting any one of conditions set in <i>Extraction condition</i>.

- 5** When the setting has been changed, click **Measure** in the *Detail* area to verify whether measurements can be made correctly.

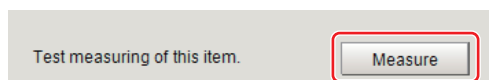

2-21-8 Judgement Conditions (Labeling)

- 1** In the Item Tab area, click **Judgement**.
- 2** If necessary, specify a value for each item.
To set feature quantities 4-7, click the **Feature data 4-7** button.

Setting item	Setting value	Description
Judgment condition <ul style="list-style-type: none"> • [None] • Number of labels • Total area • Area • Gravity X • Gravity Y • Elliptic axis angle • Elliptic major axis • Elliptic minor axis • Elliptic ratio • Rectangle width • Rectangle height • Rectangle X1 • Rectangle Y1 • Perimeter • Circularity • Fit rect major axis • Fit rect minor axis • Fit rect ratio • Inscribed circle X • Inscribed circle Y • Inscribed circle R • Circum. circle X • Circum. circle Y • Circum. circle R • Number of holes 	0.000 to 9,999,999.999	Sets up the judgment condition.

- 3** If necessary, in the *Display setting* area, set up display settings for the images displayed in the *Image Display* area.

2-21-9 Output Parameters (Labeling)

Specify how to treat the coordinates to be output to the external device as measurement results. This item can be changed if necessary. Normally, the factory default value will be used.



Precautions for Correct Use

After setting up the measurement parameters, changing the output parameters will cause measurement results to vary accordingly. If the output parameters have been changed, re-specify the measurement, too.

- 1 Click **Output parameter** in the Item tab area.
- 2 Specify each of the following items.

Setting item	Setting value [Factory default]	Description
Output coordinates	<ul style="list-style-type: none"> • [After scroll] • Before scroll 	As measurement results, select whether to output coordinate values to external devices before or after the position deflection correction is applied.
Calibration	<ul style="list-style-type: none"> • ON • [OFF] 	Select whether to reflect the calibration in the values output to the external device as measurement results. <ul style="list-style-type: none"> • ON: Output the coordinates converted into actual dimensions. • OFF: Output the camera coordinate values.
Reflect to overall judgment	<ul style="list-style-type: none"> • [ON] • OFF 	Enables choosing whether or not the judgement results of this processing unit is reflected in the scene overall judgment.



Additional Information

For output coordinates and calibration, refer to *Appendixes Measurement Mechanism Handling Coordinates* in the *Vision System FH/FHV Series User's Manual (Cat. No. Z365)*.

2-21-10 Key Points for Test Measurement and Adjustment (Labeling)

The following content is displayed in the *Detail result* area as text.

Displayed item	Description
Judge	Judgment results 0: No judgment (unmeasured) 1: Judgment result OK -1: Judgment result NG -10: Error (image format mismatch) -11: Error (unregistered model) -12: Error (insufficient memory) -20: Error (other errors)
No. of labels	No. of labels
Area	Area
Gravity X	Gravity X coordinate
Gravity Y	Gravity Y coordinate

The image specified in the Sub-image number in the image display setting is displayed in the *Image Display* area.

Sub-image number	Description of image to be displayed
0	Measurement image

Sub-image number	Description of image to be displayed
1	Extracted image

Key Points for Adjustment (Labeling)

Adjust the setting parameters referring to the following points.

● When the measurement results are unstable (for color cameras)

Parameter to be adjusted	Remedy
Color	Click the area whose color will be sampled and the area whose color will not be sampled. The setup should be such that two stable sections of hue, saturation and brightness are formed.

● When the measurement results are unstable (for monochrome cameras)

Parameter to be adjusted	Remedy
Color	Adjust the <i>Binary level</i> .

2-21-11 Measurement Results for Which Output Is Possible (Labeling)

The following values can be output using processing items related to result output. It is also possible to reference measurement values from calculation expressions and other processing units.

Measurement items	Character string	Description
Judge	JG	Judgment results 0: No judgment (unmeasured) 1: Judgment result OK -1: Judgment result NG -10: Error (image format mismatch) -11: Error (unregistered model) -12: Error (insufficient memory) -20: Error (other errors)
No. of labels	L	No. of labels
Total area	TAR	Total area
Area	AR	Area
Gravity X	X	Gravity X coordinate
Gravity Y	Y	Gravity Y coordinate
Ref. area	SA	Reference for the area
Ref. coordinate X	SX	X coordinate of the reference position
Ref. coordinate Y	SY	Y coordinate of the reference position
Feature data 0 to 7	FDA to FDH	Measurement value of Feature data selected in the judgment condition.
Feature data 0 to 7 [0]	FDA0 to FDH0	Measurement date of feature quantity
Feature data 0 to 7 [1]	FDA1 to FDH1	Measurement date of feature quantity
Feature data 0 to 7 [2]	FDA2 to FDH2	Measurement date of feature quantity
:	:	:
:	:	:

Measurement items	Character string	Description
Feature data 0 to 7 [99]	FDA99 to FDH99	Measurement date of feature quantity

2-21-12 External Reference Tables (Labeling)

No.	Data name	Data ident	Set/Get	Data range
0	Judge	judge	Get only	0: No judgment (unmeasured), 1: Judgment result OK, -1: Judgment result NG, -10: Error (image format mismatch), -11: Error (unregistered model), -12: Error (insufficient memory), -20: Error (other errors)
5	Number of labels	numOfLabels	Get only	0 to 9,999
6	Area	area	Get only	0 to 999,999,999.9999
7	Gravity X	gravityX	Get only	-99,999.9999 to 99,999.9999
8	Gravity Y	gravityY	Get only	-99,999.9999 to 99,999.9999
9	Reference area	referenceAreaMS	Get only	0 to 999,999,999.9999
10	Reference X	referenceX	Get only	-99,999.9999 to 99,999.9999
11	Reference Y	referenceY	Get only	-99,999.9999 to 99,999.9999
50+N (N=0 to 7)	Feature data	featDataVal0 to featDataVal7	Get only	-999,999,999.9999 to 999,999,999.9999
101	Output coordinates	outputCoordinate	Set/Get	0:After scroll 1:Before scroll
102	Calibration	calibration	Set/Get	0: OFF, 1: ON
103	Reflect to overall judgement	overallJudge	Set/Get	0:ON 1:OFF
126	Extract image	extractImage	Set/Get	0: OFF, 1: ON
128	Reference area	referenceArea	Set/Get	0 to 999,999,999
129	Reference X	referencePosX	Set/Get	0 to 99,999.9999
130	Reference Y	referencePosY	Set/Get	0 to 99,999.9999
131	Color inv.(reverse for monochrome)	arealnv	Set/Get	0: OFF, 1: ON
132	Filling up holes	fillingUpHoles	Set/Get	0: OFF, 1: ON
133	Outside trimming	trimming	Set/Get	0: OFF, 1: ON
134	Upper limit of the object area range	upperLabelArea	Set/Get	0 to 999,999,999
135	Lower limit of the object area range	lowerLabelArea	Set/Get	0 to 999,999,999

No.	Data name	Data ident	Set/Get	Data range
136	Sort condition	sortCondition	Set/Get	0/1:Area Ascending/ Descending 2/3:Gravity X Ascending/Descending 4/5:Gravity Y Ascending/ Descending 6/7:Elliptic major axis Ascending/Descending 8/9:Elliptic minor axis As- cending/Descending 10/11:Elliptic ratio Ascend- ing/Descending 12/13:Rec- tangle width Ascending/ Descending14/15:Rectangle height Ascending/Descend- ing 16/17:Rectangle X1 As- cending/Descending 18/19:Rectangle Y1 Ascend- ing/Descending 20/21:Perim- eter Ascending/Descending 22/23:Circularity Ascending/ Descending 24/25:Fit rect major axis Ascending/ Descending 26/27:Fit rect minor axis Ascending/ Descending 28/29:Fit rect ra- tio Ascending/Descending 30/31:Inscribed circle X As- cending/Descending 32/33:Inscribed circle Y As- cending/Descending 34/35:Inscribed circle R As- cending/Descending 36/37:Circum. circle X As- cending/Descending 38/39:Circum. circle Y As- cending/Descending 40/41:Circum. circle R As- cending/Descending 42/43:Number of holes As- cending/Descending
137	Label No.	labelNo	Set/Get	0 to 9,998
138	Upper limit of the number of labels	upperLabel	Set/Get	0 to 9,999
139	Lower limit of the number of labels	lowerLabel	Set/Get	0 to 9,999
140	Upper limit of the area	upperArea	Set/Get	0 to 999,999,999.9999
141	Lower limit of the area	lowerArea	Set/Get	0 to 999,999,999.9999
142	Upper limit of the gravity X	upperGravityX	Set/Get	-99,999.9999 to 99,999.9999
143	Lower limit of the gravity X	lowerGravityX	Set/Get	-99,999.9999 to 99,999.9999

No.	Data name	Data ident	Set/Get	Data range
144	Upper limit of the gravity Y	upperGravityY	Set/Get	-99,999.9999 to 99,999.9999
145	Lower limit of the gravity Y	lowerGravityY	Set/Get	-99,999.9999 to 99,999.9999
146	Upper limit of the binary level(for monochrome cameras only)	upperBinary	Set/Get	0 to 255
147	Lower limit of the binary level(for monochrome cameras only)	lowerBinary	Set/Get	0 to 255
148	Binary image(for monochrome cameras only)	binaryImage	Set/Get	0: OFF, 1: ON
149	Image kind	imageKind	Set/Get	0: Measurement image, 1: All color image, 2: Selection color image, 3: Binary image
150	Multiple selections	multiSelect	Set/Get	0: Multiselect NG, 1: MultiSelect OK
153	Extraction condition	filterCondSetting	Set/Get	0: AND, 1: OR
154	Label maximum	labelMaxNum	Set/Get	1 to 9,999
155	Mode	neighborhoodMode	Set/Get	0: 4-neighbor, 1: 8-neighbor
160+N×10 (N=0 to 7)	Flag used for registered color	flag0 to flag7	Set/Get	0: Not used, 1: Used
161+N×10 (N=0 to 7)	Flag for registered color OR/NOT	orNot0 to orNot7	Set/Get	0: OR, 1: NOT
162+N×10 (N=0 to 7)	Register the max. color hue	upperH0 to upperH7	Set/Get	0 to 359
163+N×10 (N=0 to 7)	Register the min. color hue	lowerH0 to lowerH7	Set/Get	0 to 359
164+N×10 (N=0 to 7)	Register the max. color saturation	upperS0 to upperS7	Set/Get	0 to 255
165+N×10 (N=0 to 7)	Register the min. color saturation	lowerS0 to lowerS7	Set/Get	0 to 255
166+N×10 (N=0 to 7)	Register the max. color brightness	upperV0 to upperV7	Set/Get	0 to 255
167+N×10 (N=0 to 7)	Register the min. color brightness	lowerV0 to lowerV7	Set/Get	0 to 255
168+N×10 (N=0 to 7)	Background color	background0 to background7	Set/Get	0: Black, 1: White, 2: Red, 3: Green, 4: Blue
301	Setting unit of reference coordinate	refUnitNo	Set/Get	-1 to 9,999
302	Setting type of reference coordinate	refSettingType	Set/Get	0:Numerical 1:Unit
303	Use point coordinate before scroll	beforeScrollRefMode	Set/Get	0:Not use 1:Use
304	Reference X before scroll	beforeScrollRefPosX	Set/Get	-99,999.9999 to 99,999.9999
305	Reference Y before scroll	beforeScrollRefPosY	Set/Get	-99,999.9999 to 99,999.9999

No.	Data name	Data ident	Set/Get	Data range
316	Dynamic mask unit reference no	DynUnitNo	Set/Get	-1 to 9,999
317	Dynamic mask image no	DynImageNo	Set/Get	0 to 99
319	Display image type	ChkChoose	Set/Get	0: Measure image. 1: Mask binary image. 2: Mask and image
325	Mask region display color	maskRegionColor	Set/Get	0: Black, 1: White, 2: Red, 3: Green, 4: Blue
501+N×10 (N=0 to 2)	Filter condition	filterCond0 to filter-Cond2	Set/Get	0: Not selected. 1: Area, 2/3: Gravity X/Gravity Y, 4/5: Elliptic major axis/Elliptic minor axis, 6: Elliptic ratio, 7/8: Rectangle width/Rectangle height, 9/10: Rectangle X1/Rectangle Y1, 11: Perimeter, 12: Circularity, 13/14: Fit rect major axis/Fit rect minor axis, 15: Inscribed circle R, 16: Circum. circle R, 17: Number of holes
503+N×10 (N=0 to 2)	Upper limit of filter condition	upperFilter0 to upperFilter2	Set/Get	-999,999,999.9999 to 999,999,999.9999
504+N×10 (N=0 to 2)	Lower limit of filter condition	lowerFilter0 to upper-Filter2	Set/Get	-999,999,999.9999 to 999,999,999.9999
600+N×10 (N=0 to 7)	Judge condition	featCond0 to feat-Cond7	Set/Get	0: Not selected, 1: Number of labels, 2: Total area, 3: Area, 4/5: Gravity X/Gravity Y, 6: Elliptic axis angle, 7/8: Elliptic major axis/Elliptic minor axis, 9: Elliptic ratio, 10/11: Rectangle width/Rectangle height, 12/13: Rectangle X1/Rectangle Y1, 14: Perimeter, 15: Circularity, 16/17: Fit rect major axis/Fit rect minor axis, 18: Fit rect ratio, 19/20: Inscribed circle X/Inscribed circle Y, 21: Inscribed circle R, 22/23: Circum. circle X/Circum. circle Y, 24: Circum. circle R, 25: Number of holes
601+N×10 (N=0 to 7)	Judge condition display flag	featDisp0 to feat-Disp7	Set/Get	0 to 1
602+N×10 (N=0 to 7)	Upper limit of judge condition	upperFeat0 to upper-Feat7	Set/Get	-999,999,999.9999 to 999,999,999.9999
603+N×10 (N=0 to 7)	Lower limit of judge condition	lowerFeat0 to lower-Feat7	Set/Get	-999,999,999.9999 to 999,999,999.9999
1,000+N (N=0 to 99)	Feature data A	FDA00 to FDA99	Get only	-999,999,999.9999 to 999,999,999.9999

No.	Data name	Data ident	Set/Get	Data range
1,100+N (N=0 to 99)	Feature data B	FDB00 to FDB99	Get only	-999,999,999.9999 to 999,999,999.9999
1,200+N (N=0 to 99)	Feature data C	FDC00 to FDC99	Get only	-999,999,999.9999 to 999,999,999.9999
1,300+N (N=0 to 99)	Feature data D	FDD00 to FDD99	Get only	-999,999,999.9999 to 999,999,999.9999
1,400+N (N=0 to 99)	Feature data E	FDE00 to FDE99	Get only	-999,999,999.9999 to 999,999,999.9999
1,500+N (N=0 to 99)	Feature data F	FDF00 to FDF99	Get only	-999,999,999.9999 to 999,999,999.9999
1,600+N (N=0 to 99)	Feature data G	FDG00 to FDG99	Get only	-999,999,999.9999 to 999,999,999.9999
1,700+N (N=0 to 99)	Feature data H	FDH00 to FDH99	Get only	-999,999,999.9999 to 999,999,999.9999
6,002	Format	cameraColor	Set/Get	1: Monochrome camera, 2: Color camera
90,000	Inspection area figure Count	figArea0_count	Set/Get	0 to 8
90,001	Inspection area figure0 Type	figArea0_fig0_type	Set/Get	8: Rectangle, 16: Ellipse, 64: Circumference, 256: Wide arc, 512: Polygon
90,002	Inspection area figure0 mode	figArea0_fig0_mode	Set/Get	0: OR, 1: NOT
90,014	Inspection area figure0 Rectangle Upper left position X	figArea0_fig0_box_X0	Set/Get	-99,999 to 99,999
90,015	Inspection area figure0 Rectangle Upper left position Y	figArea0_fig0_box_Y0	Set/Get	-99,999 to 99,999
90,016	Inspection area figure0 Rectangle Lower right position X	figArea0_fig0_box_X1	Set/Get	-99,999 to 99,999
90,017	Inspection area figure0 Rectangle Lower right position Y	figArea0_fig0_box_Y1	Set/Get	-99,999 to 99,999
90,018	Inspection area figure0 Ellipse Center Position X	figArea0_fig0_ellipse_CX	Set/Get	-99,999 to 99,999
90,019	Inspection area figure0 Ellipse Center Position Y	figArea0_fig0_ellipse_CY	Set/Get	-99,999 to 99,999
90,020	Inspection area figure0 Ellipse RadiusX	figArea0_fig0_ellipse_RX	Set/Get	1 to 99,999
90,021	Inspection area figure0 Ellipse RadiusY	figArea0_fig0_ellipse_RY	Set/Get	1 to 99,999
90,025	Inspection area figure0 Circumference Center Position X	figArea0_fig0_circleW_X	Set/Get	-99,999 to 99,999
90,026	Inspection area figure0 Circumference Center Position Y	figArea0_fig0_circleW_Y	Set/Get	-99,999 to 99,999

No.	Data name	Data ident	Set/Get	Data range
90,027	Inspection area figure0 Circumference Radius	figArea0_fig0_circleW_R	Set/Get	0 to 99,999
90,028	Inspection area figure0 Circumference Width	figArea0_fig0_circleW_W	Set/Get	0 to 99,999
90,034	Inspection area figure0 Wide arc Center Position X	figArea0_fig0_arcW_X	Set/Get	-99,999 to 99,999
90,035	Inspection area figure0 Wide arc Center Position Y	figArea0_fig0_arcW_Y	Set/Get	-99,999 to 99,999
90,036	Inspection area figure0 Wide arc Radius	figArea0_fig0_arcW_R	Set/Get	0 to 99,999
90,037	Inspection area figure0 Wide arc Start angle	figArea0_fig0_arcW_SA	Set/Get	-180 to 180
90,038	Inspection area figure0 Wide arc End angle	figArea0_fig0_arcW_EA	Set/Get	-180 to 180
90,039	Inspection area figure0 Wide arc Width	figArea0_fig0_arcW_W	Set/Get	0 to 99,999
90,040	Inspection area figure0 Polygon Point Count	figArea0_fig0_polygon_count	Set/Get	3 to 10
90,041	Inspection area figure0 Polygon Point1 Position X	figArea0_fig0_polygon_x0	Set/Get	-99,999 to 99,999
90,042	Inspection area figure0 Polygon Point1 Position Y	figArea0_fig0_polygon_y0	Set/Get	-99,999 to 99,999
:	:	:	:	:
90,059	Inspection area figure0 Polygon Point10 Position X	figArea0_fig0_polygon_x9	Set/Get	-99,999 to 99,999
90,060	Inspection area figure0 Polygon Point10 Position Y	figArea0_fig0_polygon_y9	Set/Get	-99,999 to 99,999
90,099	Inspection area figure Update	figArea0_update	Set only	1: Update
:	:	:	:	:
90,201	Inspection area figure2 Type	figArea0_fig2_type	Set/Get	8: Rectangle, 16: Ellipse, 64: Circumference, 256: Wide arc, 512: Polygon
:	:	:	:	:
90,301	Inspection area figure3 Type	figArea0_fig3_type	Set/Get	8: Rectangle, 16: Ellipse, 64: Circumference, 256: Wide arc, 512: Polygon
:	:	:	:	:

No.	Data name	Data ident	Set/Get	Data range
90,401	Inspection area figure4 Type	figArea0_fig4_type	Set/Get	8: Rectangle, 16: Ellipse, 64: Circumference, 256: Wide arc, 512: Polygon
:	:	:	:	:
90,501	Inspection area figure5 Type	figArea0_fig5_type	Set/Get	8: Rectangle, 16: Ellipse, 64: Circumference, 256: Wide arc, 512: Polygon
:	:	:	:	:
90,601	Inspection area figure6 Type	figArea0_fig6_type	Set/Get	8: Rectangle, 16: Ellipse, 64: Circumference, 256: Wide arc, 512: Polygon
:	:	:	:	:
90,701	Inspection area figure7 Type	figArea0_fig7_type	Set/Get	8: Rectangle, 16: Ellipse, 64: Circumference, 256: Wide arc, 512: Polygon
:	:	:	:	:
91,000	Mask area figure Count	figArea1_count	Set/Get	1
91,001	Mask area figure0 Type	figArea1_fig0_type	Set/Get	8: Rectangle
91,002	Mask area figure0 mode	figArea1_fig0_mode	Set/Get	0:OR
91,014	Mask area figure0 Rectangle Upper left position X	figArea1_fig0_box_X0	Set/Get	-99,999 to 99,999
91,015	Mask area figure0 Rectangle Upper left position Y	figArea1_fig0_box_Y0	Set/Get	-99,999 to 99,999
91,016	Mask area figure0 Rectangle Lower right position X	figArea1_fig0_box_X1	Set/Get	-99,999 to 99,999
91,017	Mask area figure0 Rectangle Lower right position Y	figArea1_fig0_box_Y1	Set/Get	-99,999 to 99,999
91,099	Mask area figure Update	figArea1_update	Set only	1: Update
92,000	Selected area figure Count	figArea2_count	Set/Get	0 to 8
92,001	Selected area figure0 Type	figArea2_fig0_type	Set/Get	8: Rectangle
92,002	Selected area figure0 mode	figArea2_fig0_mode	Set/Get	0: OR, 1: NOT
92,014	Selected area figure0 Rectangle Upper left position X	figArea2_fig0_box_X0	Set/Get	-99,999 to 99,999
92,015	Selected area figure0 Rectangle Upper left position Y	figArea2_fig0_box_Y0	Set/Get	-99,999 to 99,999
92,016	Selected area figure0 Rectangle Lower right position X	figArea2_fig0_box_X1	Set/Get	-99,999 to 99,999

No.	Data name	Data ident	Set/Get	Data range
92,017	Selected area figure0 Rectangle Lower right position Y	figArea2_fig0_box_Y1	Set/Get	-99,999 to 99,999
92,099	Selected area figure Update	figArea2_update	Set only	1: Update
92,101	Selected area figure1 Type	figArea2_fig1_type	Set/Get	8: Rectangle
:	:	:	:	:
92,201	Selected area figure2 Type	figArea2_fig2_type	Set/Get	8: Rectangle
:	:	:	:	:
92,301	Selected area figure3 Type	figArea2_fig3_type	Set/Get	8: Rectangle
:	:	:	:	:
92,401	Selected area figure4 Type	figArea2_fig4_type	Set/Get	8: Rectangle
:	:	:	:	:
92,501	Selected area figure5 Type	figArea2_fig5_type	Set/Get	8: Rectangle
:	:	:	:	:
92,601	Selected area figure6 Type	figArea2_fig6_type	Set/Get	8: Rectangle
:	:	:	:	:
92,701	Selected area figure7 Type	figArea2_fig7_type	Set/Get	8: Rectangle
:	:	:	:	:
92,717	Selected area figure7 Rectangle Lower right position Y	figArea2_fig7_box_Y1	Set/Get	-99,999 to 99,999

2-22 Label Data

This processing item can not be used in the FHV series.

You can specify a desired label number and obtain measurement values for that label stored by other processing units.

The processing items that can be set up as reference objects are the following items that perform the labeling processing.

- Labeling

Used in the Following Case

Label position acquisition:

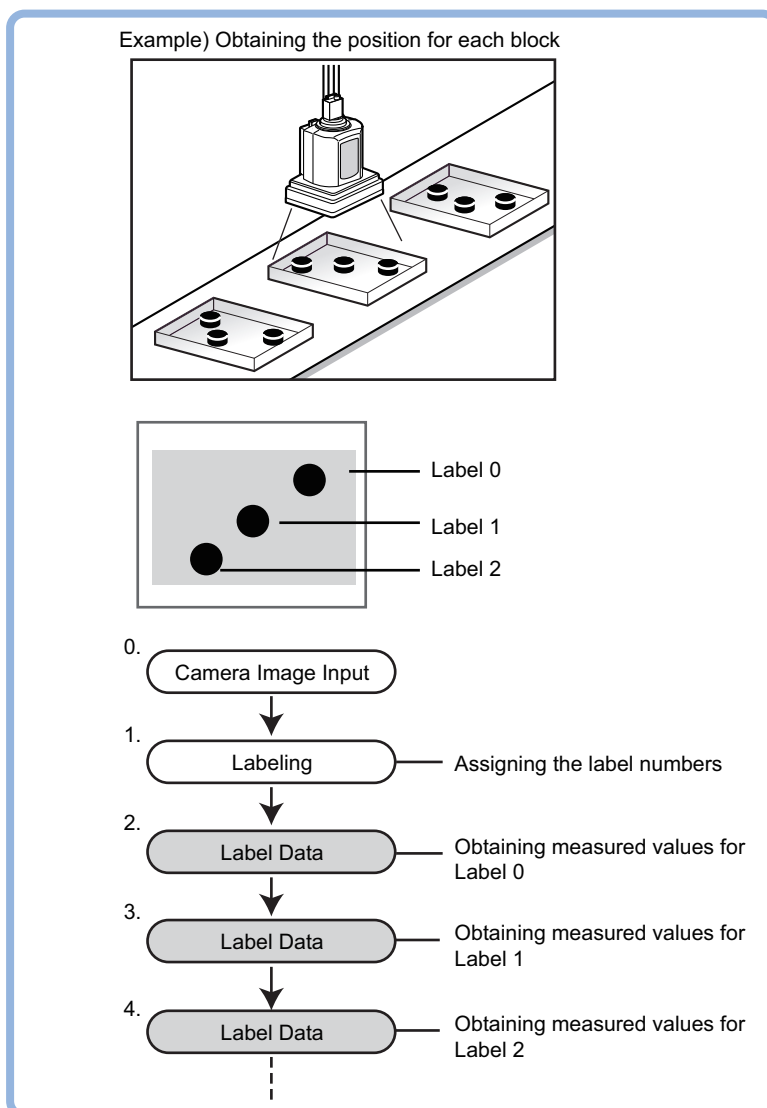



Additional Information

Do not insert the following processing items between Label Data and Labeling units.

- Camera Image Input
- Camera Switching
- Position Compensation
- Color Gray Filter
- Filtering

2-22-1 Settings Flow (Label Data)

To set Label Data, follow the steps below.

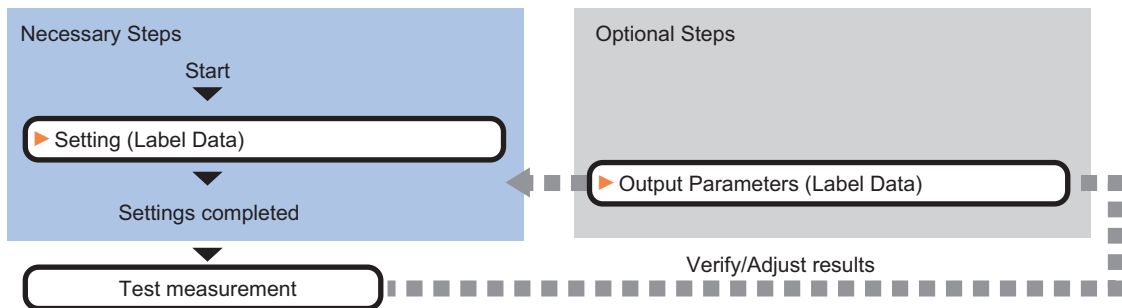

List of Label Data Items

Item	Description
Setting	Specify the unit number and label number of the processing unit that is designated as the reference object. Sets processing conditions for measurement and judgment conditions for measurement results. Specify the upper and lower limit values for the area and the gravity center <i>2-22-2 Setting (Label Data) on page 2-344</i>
Output parameter	This item can be changed as necessary. Normally, the factory default value will be used. Use the output parameter to specify how to handle the coordinates. <i>2-22-3 Output Parameters (Label Data) on page 2-345</i>

2-22-2 Setting (Label Data)

Specify the unit number and label number of the unit set for labeling reference. In addition, specify the judgement conditions for measurement results.

After changing a setting, check whether measurement can be done properly by performing an actual measurement.

- 1** In the Item Tab area, click **Setting**.
- 2** In the *Label setting* area, specify each item.

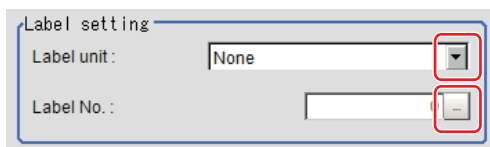

Setting item	Setting value [Factory default]	Description
Label unit	None to 9,999 [None]	Specifies the number of the unit for which the reference object processing item has been set up. As an option, display the number of the unit for which the following processing items have been set up. <ul style="list-style-type: none"> Labeling
Label No.	0 to 9,998 [0]	Specifies the number of the label for the reference object.

- 3** When the setting has been changed, click **Measure** in the *Detail* area to verify whether measurements can be made correctly.

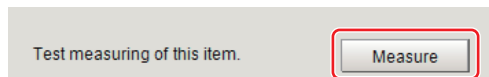

- 4** Set up the judgment condition.



Additional Information

The values beside each item are measurement results of the displayed image. Take these values into consideration to determine the upper and lower limit values.

Setting item	Setting value	Description
Area	0 to 999,999,999.9999	Specify the area to be judged as OK.
Gravity X	-99,999.9999 to 99,999.9999	Specify the range of X-axis shifting that is judged to be OK.
Gravity Y	-99,999.9999 to 99,999.9999	Specify the range of Y-axis shifting that is judged to be OK.

2-22-3 Output Parameters (Label Data)

Specify how to treat the coordinates to be output to the external device as measurement results. This item can be changed if necessary. Normally, the factory default value will be used.



Precautions for Correct Use

After setting up the measurement parameters, changing the output parameters will cause measurement results to vary accordingly. If the output parameters have been changed, re-specify the measurement, too.

- 1 Click **Output parameter** in the Item tab area.
- 2 Specify each of the following items.

Setting item	Setting value [Factory default]	Description
Output coordinates	<ul style="list-style-type: none"> [After scroll] Before scroll 	As measurement results, select whether to output coordinate values to external devices before or after the position deflection correction is applied.

Setting item	Setting value [Factory default]	Description
Calibration	<ul style="list-style-type: none"> • ON • [OFF] 	Select whether to reflect the calibration in the values output to the external device as measurement results. <ul style="list-style-type: none"> • ON: Output the coordinates converted into actual dimensions. • OFF: Output the camera coordinate values.
Reflect to overall judgment	<ul style="list-style-type: none"> • [ON] • OFF 	Enables choosing whether or not the judgement results of this processing unit is reflected in the scene overall judgment.



Additional Information

For output coordinates and calibration, refer to *Appendixes Measurement Mechanism Handling Coordinates* in the *Vision System FH/FHV Series User's Manual (Cat. No. Z365)*.

2-22-4 Key Points for Test Measurement and Adjustment (Label Data)

The following content is displayed in the *Detail result* area as text.

Displayed item	Description
Judge	Judgment results 0: No judgment (unmeasured) 1: Judgment result OK -1: Judgment result NG -10: Error (image format mismatch) -11: Error (unregistered model) -12: Error (insufficient memory) -20: Error (other errors)
Area	Area
Gravity X	Gravity X coordinate
Gravity Y	Gravity Y coordinate

2-22-5 Measurement Results for Which Output Is Possible (Label Data)

The following values can be output using processing items related to result output. It is also possible to reference measurement values from calculation expressions and other processing units.

Measurement items	Character string	Description
Judge	JG	Judgment results 0: No judgment (unmeasured) 1: Judgment result OK -1: Judgment result NG -10: Error (image format mismatch) -11: Error (unregistered model) -12: Error (insufficient memory) -20: Error (other errors)
Label No.	LN	Label No.
Area	AR	Area
Gravity X-coordinate	X	Gravity X coordinate
Gravity Y-coordinate	Y	Gravity Y coordinate

2-22-6 External Reference Tables (Label Data)

No.	Data name	Data ident	Set/Get	Data range
0	Judge	judge	Get only	0: No judgment (unmeasured), 1: Judgment result OK, -1: Judgment result NG, -10: Error (image format mismatch), -11: Error (unregistered model), -12: Error (insufficient memory), -20: Error (other errors)
5	Label No.	label	Get only	0 to 9,998
6	Area	area	Get only	0 to 999,999,999.9999
7	Gravity X	gravityX	Get only	-99,999.9999 to 99,999.9999
8	Gravity Y	gravityY	Get only	-99,999.9999 to 99,999.9999
101	Output coordinates	outputCoordinate	Set/Get	0: After scroll 1: Before scroll
102	Calibration	calibration	Set/Get	0: OFF, 1: ON
103	Reflect to overall judgement	overallJudge	Set/Get	0: ON, 1: OFF
120	Label unit	labelUnit	Set/Get	-1: OFF 0 to 9,999: Unit No.
121	Label No.	labelNo	Set/Get	0 to 9,998
122	Upper limit of the area	upperArea	Set/Get	0 to 999,999,999.9999
123	Lower limit of the area	lowerArea	Set/Get	0 to 999,999,999.9999
124	Upper limit of gravity X	upperGravityX	Set/Get	-99,999.9999 to 99,999.9999
125	Lower limit of gravity X	lowerGravityX	Set/Get	-99,999.9999 to 99,999.9999
126	Upper limit of gravity Y	upperGravityY	Set/Get	-99,999.9999 to 99,999.9999
127	Lower limit of gravity Y	lowerGravityY	Set/Get	-99,999.9999 to 99,999.9999

2-23 Defect

This processing item can not be used in the FHV series.

Detect defects and contamination using color variation within the measurement region.

This is real color processing, so even if defect and contamination colors change or the background color changes, stable inspection is possible.

Used in the Following Case

- Detecting defects, contaminations and spots on plain measurement objects:

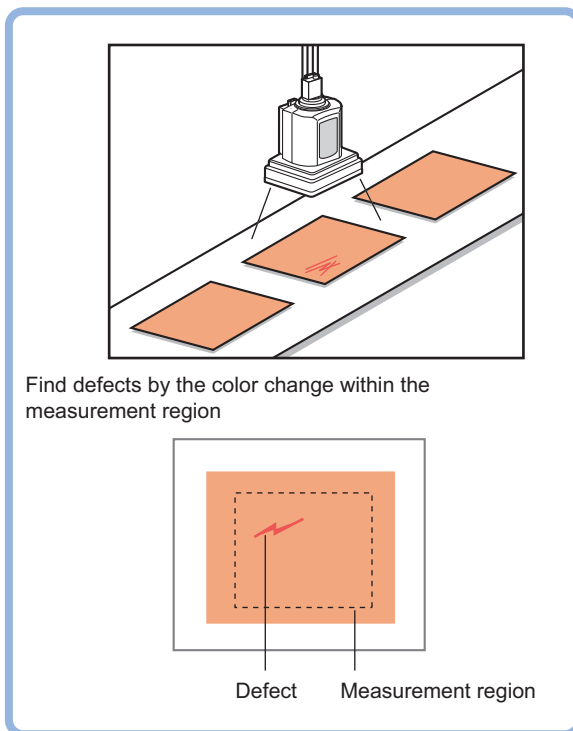

- Measure appearance defects and defects of parts:

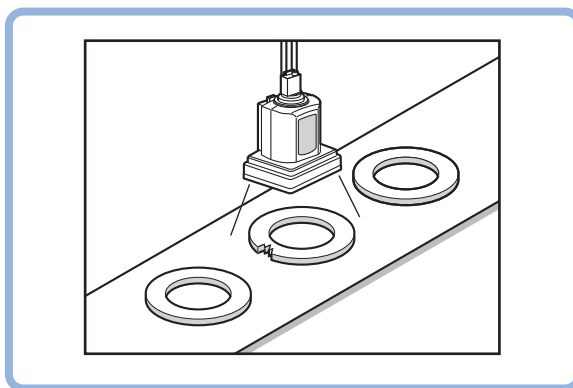

Precautions for Correct Use

Processing is different for color images and monochrome images. When the camera type used in the previous setup was changed to color or monochrome type, perform the settings again.

**Additional Information**

With Defect, defects and contamination on patterns and characters can not be detected.

2-23-1 Settings Flow (Defect)

To set Defect, follow the steps below.

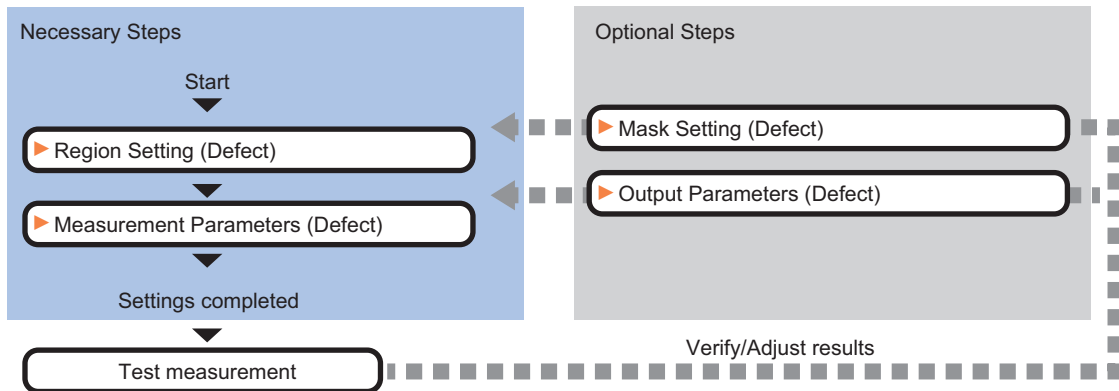
**Settings Flow (Defect)**

Item	Description
Region setting	Sets the measurement area. It is possible to target the entire screen, but restricting the range can shorten the processing time. <i>2-23-2 Region Setting (Defect) on page 2-349</i>
Mask setting	Set it when masking a region. The measurement result of another processing item can also be used for masking. <i>2-23-3 Mask Setting (Defect) on page 2-350</i>
Measurement parameter	Measurement parameter can be changed as needed to address unstable measurement results. Normally, the factory default value will be used. <i>2-23-4 Measurement Parameters (Defect) on page 2-354</i>
Output parameter	This item can be changed as necessary. Normally, the factory default value will be used. Use the output parameter to specify how to handle the coordinates. <i>2-23-5 Output parameter (Defect) on page 2-357</i>

2-23-2 Region Setting (Defect)

This item is used to set up the measurement area.

Use a rectangle, wide line, ellipse (circle), wide circle, wide arc or polygon to specify a measurement region for *Defect*. Up to 8 figures can be drawn.

**Precautions for Correct Use**

A mask cannot be made with only one region specified using *Wide line*, *Wide circle*, or *Arc*, as the figure.

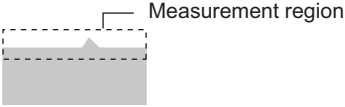
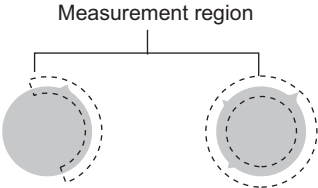
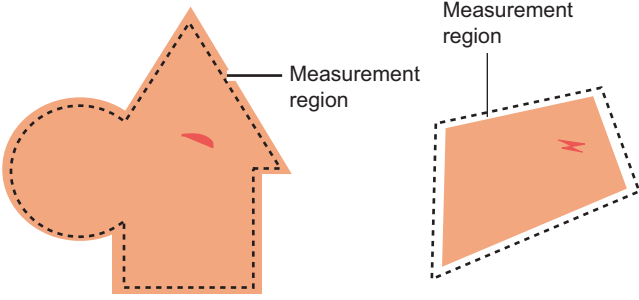
PT	Description
Wide line	Selected when detecting defects and burrs of the measurement objects. 
Wide circle, wide arc	Selected when detecting defects and burrs of the circle measurement objects. 
Rectangle, ellipse (circle), polygon	Selected when detecting the overall defects of specified zones and measurement objects. 

- 1** In the Item tab area, click **Region setting**.
- 2** Use the drawing tools to set the measurement region.
Up to 8 figures can be combined.
- 3** Click **OK** in the *Figure setting* area.
 - **OK**: Changes the settings and returns to the previous menu.
 - **Cancel**: Changes are discarded. Returns to the previous menu.
 - **Apply**: Updates the settings without leaving edit window.

2-23-3 Mask Setting (Defect)

Mask the measurement region when measuring it.

There are two types of masks, namely, a static mask that sets the mask region independent of measurement and a dynamic mask that uses images generated in another unit for each measurement



Precautions for Correct Use

A mask cannot be made with only one region specified using *Wide line*, *Wide circle*, or *Arc*, as the figure.

Creating a static mask

A static mask can be created manually or from an image of another unit.

- 1 In the *Mask setting* area, select *Static mask*.

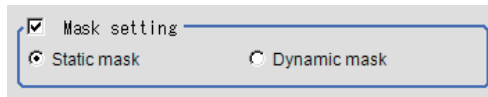

● Generating a mask manually

- 1 In the *Static mask set* area, select *Region extract*.

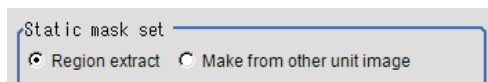

- 2 Select the selection region type OR or NOT and drag an image directly.
A region is created along successive similar colors from the selected place. It is not masked if the selection region type is OR.

It is masked if the selection region type is NOT.

To deselect a selected region, click **Undo**.

To edit a region selected with OR/NOT, click **Selected region edit**.

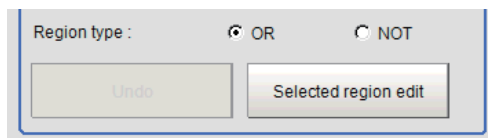

- 3 Adjust the mask created in the *Static mask setting* area.

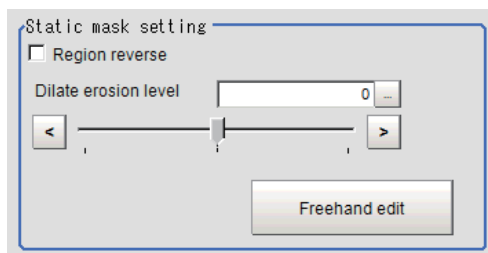

Setting item	Setting value [Factory default]	Description
Region reverse	<ul style="list-style-type: none"> • Checked • [Unchecked] 	Place a check to revert the created mask region.
Dilate erosion level	-10 to 10 [0]	Perform fine adjustment on the mask region using expansions/shrinkage. The region is expanded if a positive value is set. The region is shrunk if a negative value is set.

● Creating a static mask from an image of another unit

- 1 In the *Static mask set* area, select *Make from other unit image*.

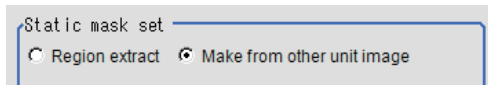

- 2 Set the unit number and image data number.

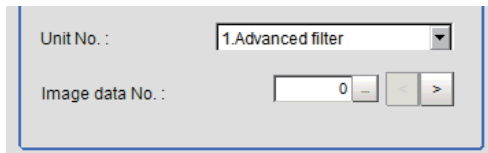

Setting item	Setting value [Factory default]	Description
Unit No.	-	Specify the number of the unit whose image will be referenced. The reference unit should be able to output binarized images. For example, select a labeling filter processing image for advanced filtering.
Image data No.	0 to 3 [0]	If the unit supports advanced filtering, numbers 0 to 3 can be set. Otherwise, it is fixed to 0.

Performing fine adjustment on a static mask

- 1 To perform fine adjustment on a mask region, click **Freehand edit** in the *Static mask setting* area.

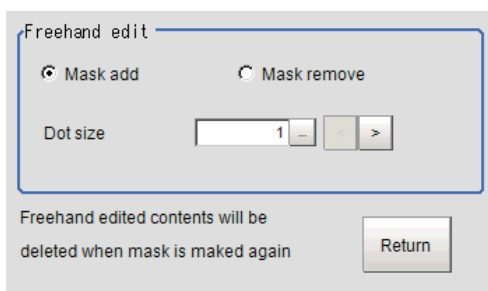

Setting item	Setting value [Factory default]	Description
Freehand edit	<ul style="list-style-type: none"> • [Mask add] • Mask remove 	Select a process performed using the free hand edit.
Dot size	1 to 20 [1]	Set the size of dots used when drawing images on the screen.

- 2 Click **Return** to exit the free hand edit.

Clearing the static mask setting

- 1 To clear the static mask setting, click **Clear**.

Creating a dynamic mask

- 1 In the *Mask setting* area, select *Dynamic mask*.

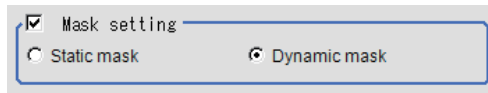

- 2 Set the unit number and image data number in the *Unit reference* area.

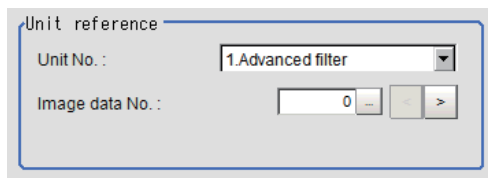

Setting item	Setting value [Factory default]	Description
Unit No.	-	Set the number of the unit being referred to for the mask region. The reference unit should be able to output binarized images. For example, select a labeling filter processing image for advanced filtering.
Image data No.	0 to 3 [0]	If the unit supports advanced filtering, numbers 0 to 3 can be set. Otherwise, it is fixed to 0.

Setting display

Perform the display setting if required.

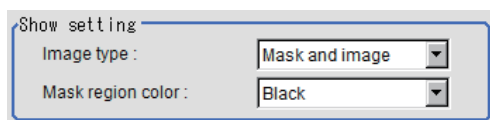

Setting item	Setting value [Factory default]	Description
Image type	<ul style="list-style-type: none"> • Measure image • Mask binary image • [Mask and image] 	Select the type of an image to be displayed.

Setting item	Setting value [Factory default]	Description
Mask region color	<ul style="list-style-type: none"> • [Black] • White • Red • Green • Blue 	<p>Select the display color of the mask region.</p> <p>A part of color which is specified in <i>Mask region color</i> is not measured.</p>

2-23-4 Measurement Parameters (Defect)

This item specifies the judgement condition for measurement results. Measurement parameters can be changed as needed to address unstable measurement results or to increase the processing speed.



Additional Information

Defect detection mechanism:

After measurement region is drawn, a rectangle (defect detection region) is automatically formed in this region. While moving the defect detection region around, calculate the RGB color averages at each location and find the defect detection difference with surrounding defect detection regions. This difference is called the defect level. Calculate the defect level for all defect detection areas. If the maximum value exceeds the judgement value, it is judged that there are defects in the measurement region.

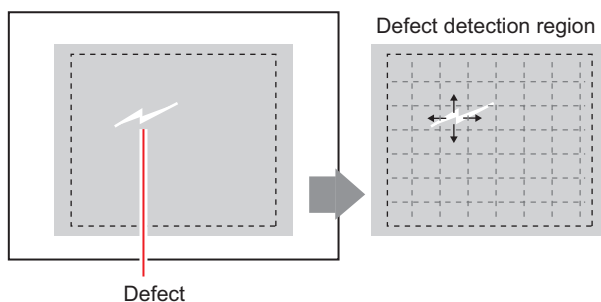

- 1** In the Item tab area, click **Measurement**.
- 2** Set the value of each item in the *Defect size* area.

Defect size

Upper:

Lower:

Setting item	Setting value [Factory default]	Description
Defect size	<ul style="list-style-type: none"> • 4 • 8 • 12 • 16 • 24 • 32 • 64 [4] to [64]	<p>Specifies the upper and lower limits of defect detection size based on the size of scratch or contamination to be detected. A defect detection region is automatically created with the number of pixels for the <i>Defect size</i>.</p> <p>The larger the difference between upper and lower limits, the easier to detect defects/contamination of various sizes. For both upper and lower limits, higher values for <i>Defect size</i> limits leads to weaker detection sensitivity and shorter processing time</p>

3 If necessary, set the value of each item in the *Measurement parameter* area.

For color cameras:

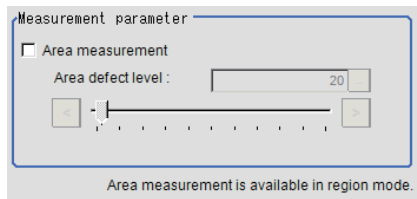

For monochrome cameras:

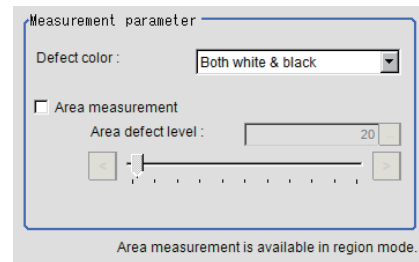

Setting item	Setting value [Factory default]	Description
Area measurement	<ul style="list-style-type: none"> • Checked • [Unchecked] 	<p>Places a check when you want to measure the size of defects. This item can divide the high defect detection regions into groups and output the surface and center of gravity coordinates of the group with the largest area. However, when only one region is specified with <i>Wide line</i>, <i>Wide circle</i>, or <i>Arc</i>, area measurement is not possible.</p>
Area defect level	0 to 999 [20]	If you place a check at Area Measurement , set defect level counted in the defect area.
Detect color (only for monochrome camera)	<ul style="list-style-type: none"> • White • Black • [White and Black] 	<ul style="list-style-type: none"> • Black: Selects this when detecting defects looking darker than the background. • White: Selects this when detecting defects looking brighter than the background. • White and Black: Selects this when the brightness of defects are not identified.



Additional Information

Region inspection mode:

The comparison direction depends on the measurement region shapes and number. For a rectangle, ellipse or polygon, comparison is with the defect detection regions above, below, left and right. This is called region inspection mode.

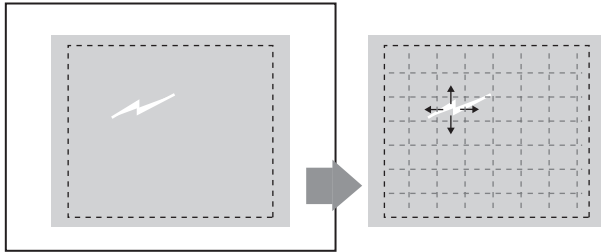

For a wide line, wide arc or wide circle, comparison is only with the two neighboring defect detection regions.

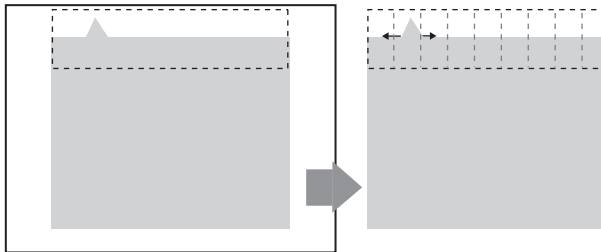

However, even for a wide line, wide arc or wide circle, when two or more figures are drawn, measurement is in region inspection mode.

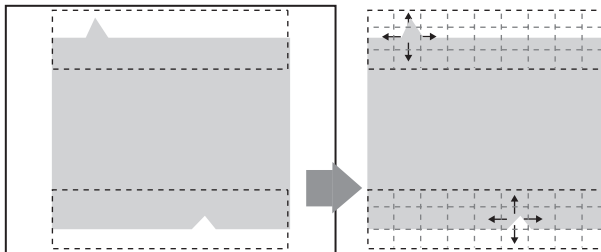

- 4 When the setting has been changed, click **Measure** in the *Detail* area to verify whether measurements can be made correctly.

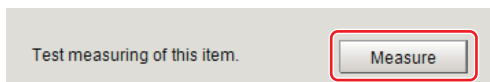

- 5 Set up the judgment condition.

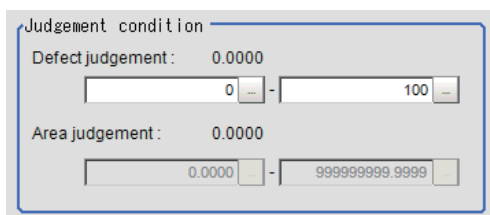

Setting item	Setting value	Description
Defect judgment	0 to 999 [0] to [100]	Specifies the range of defect judgment values that are judged to be OK.
Area judgment	0 to 999,999,999.9999 0 to 307,200 (for a 0.3-megapixel camera) 0 to 1,920,000 (for a 2-megapixel camera) 0 to 4,320,000 (for a 5-megapixel camera)	Specifies the range of area judgment values that are judged to be OK.



Additional Information

The values beside each item are measurement results of the displayed image. Take these values into consideration to determine the upper and lower limit values.

2-23-5 Output parameter (Defect)

Select whether or not to reflect the judgment results of this processing unit to the overall judgment of the scene.

- 1 In the Item tab area, click **Output parameter**.
- 2 Select whether or not to reflect it to the overall judgment in *Reflect to overall judgement* area.

Setting item	Setting value [Factory default]	Description
Reflect to overall judgment	<ul style="list-style-type: none"> • [ON] • OFF 	Enables choosing whether or not the judgement results of this processing unit is reflected in the scene overall judgment.

2-23-6 Key Points for Test Measurement and Adjustment (Defect)

The following content is displayed in the *Detail result* area as text.

Displayed item	Description
Judge	Judgment results 0: No judgment (unmeasured) 1: Judgment result OK -1: Judgment result NG -10: Error (image format mismatch) -11: Error (unregistered model) -12: Error (insufficient memory) -20: Error (other errors)
Defect	Measured defect level
Defect coordinate X	X Coordinate of measured defect position
Defect coordinate Y	Y coordinate of measured defect position
Defect area	The measured maximum defect area
Defect area gravity X	The center of gravity X coordinates of the measured maximum defect area
Defect area gravity Y	The center of gravity Y coordinates of the measured maximum defect area

The image specified in the Sub-image number in the image display setting is displayed in the *Image Display* area.

Sub-image number	Description of image to be displayed
0	Measurement image
1	Defect profile [when area measurement is present]



Precautions for Correct Use

When displaying an image with the setting of sub-image number 1, the processing time will be longer. If you want to shorten the measurement interval, set the sub-image number to 0.

Key Points for Adjustment (Defect)

Adjust the setting parameters referring to the following points.

● When noise is detected as defects

Parameter to be adjusted	Remedy
Measurement parameter	Specify a larger value for <i>Defect judgement</i> in the judgement conditions.

● When judgement will be NG

Parameter to be adjusted	Remedy
Measurement parameter	Make the measurement region larger than the lower limit of the <i>Defect size</i> . Or make the lower limit of the <i>Defect size</i> smaller than the measurement region.

● When the processing speed is slow

Parameter to be adjusted	Remedy
Measurement parameter	Specify a larger value for the <i>Defect size</i> .
	Reduce the difference between the upper and lower limits of the <i>Defect size</i> .

2-23-7 Measurement Results for Which Output Is Possible (Defect)

The following values can be output using processing items related to result output. It is also possible to reference measurement values from calculation expressions and other processing units.

Measurement items	Character string	Description
Judge	JG	Judgment results 0: No judgment (unmeasured) 1: Judgment result OK -1: Judgment result NG -10: Error (image format mismatch) -11: Error (unregistered model) -12: Error (insufficient memory) -20: Error (other errors)

Measurement items	Character string	Description
Defect	F	Measured defect level
Defect coordinate X	X	X Coordinate of measured defect position
Defect coordinate Y	Y	Y coordinate of measured defect position
Defect area	AR	The measured maximum defect area
Defect area gravity X	GX	The center of gravity X coordinates of the measured maximum defect area
Defect area gravity Y	GY	The center of gravity Y coordinates of the measured maximum defect area

2-23-8 External Reference Tables (Defect)

No.	Data name	Data ident	Set/Get	Data range
0	Judge	judge	Get only	0: No judgment (unmeasured), 1: Judgment result OK, -1: Judgment result NG, -10: Error (image format mismatch), -11: Error (unregistered model), -12: Error (insufficient memory), -20: Error (other errors)
5	Defect	defect	Get only	0 to 999
6	Position X	defectX	Get only	0 to 99,999.9999
7	Position Y	defectY	Get only	0 to 99,999.9999
8	Defect area	area	Get only	0 to 999,999,999.9999
9	Defect gravity X	gravityX	Get only	0 to 99,999.9999
10	Defect gravity Y	gravityY	Get only	0 to 99,999.9999
103	Reflect to overall judgement	overallJudge	Set/Get	0: ON, 1: OFF
120	Upper limit of defect size	upperDefect	Set/Get	0: 4, 1: 8, 2: 12, 3: 16, 4: 24, 5: 32, 6: 64
121	Lower limit of defect size	lowerDefect	Set/Get	0: 4, 1: 8, 2: 12, 3: 16, 4: 24, 5: 32, 6: 64
122	Upper limit of defect judgement	criteriaValue	Set/Get	0 to 999
123	Defect color	colorWound	Set/Get	0: Both, 1: White, 2: Black
124	Area measurement	measArea	Set/Get	0: OFF, 1: ON
125	Area meas. LV	areaJudge	Set/Get	0 to 999
126	Upper limit of area judgement	upperArea	Set/Get	0 to 999,999,999.9999
127	Lower limit of area judgement	lowerArea	Set/Get	0 to 999,999,999.9999
128	Lower limit of defect judgement	lowerCriteriaValue	Set/Get	0 to 999
155	Dynamic mask unit reference no	dynUnitNo	Set/Get	-1 to 9,999
156	Dynamic mask image no	dynImageNo	Set/Get	0 to 99

No.	Data name	Data ident	Set/Get	Data range
158	Display image type	chkChoose	Set/Get	0: Measure image, 1: Mask binary image, 2: Mask and image
164	Mask region display color	maskRegionColor	Set/Get	0: Black, 1: White, 2: Red, 3: Green, 4: Blue
6,002	Format	cameraColor	Set/Get	1: Monochrome camera 2: Color camera
90,000	Inspection area figure Count	figArea0_count	Set/Get	0 to 8
90,001	Inspection area figure0 Type	figArea0_fig0_type	Set/Get	4: Wide line, 8: Rectangle, 16: Ellipse, 64: Circumference, 256: Wide arc, 512: Polygon
90,002	Inspection area figure0 mode	figArea0_fig0_mode	Set/Get	0: OR, 1: NOT
90,009	Inspection area figure0 Wide line Start point X	figArea0_fig0_lineW_X0	Set/Get	-99,999 to 99,999
90,010	Inspection area figure0 Wide line Start point Y	figArea0_fig0_lineW_Y0	Set/Get	-99,999 to 99,999
90,011	Inspection area figure0 Wide line End point X	figArea0_fig0_lineW_X1	Set/Get	-99,999 to 99,999
90,012	Inspection area figure0 Wide line End point Y	figArea0_fig0_lineW_Y1	Set/Get	-99,999 to 99,999
90,013	Inspection area figure0 Wide line Width	figArea0_fig0_lineW_W	Set/Get	0 to 99,999
90,014	Inspection area figure0 Rectangle Upper left position X	figArea0_fig0_box_X0	Set/Get	-99,999 to 99,999
90,015	Inspection area figure0 Rectangle Upper left position Y	figArea0_fig0_box_Y0	Set/Get	-99,999 to 99,999
90,016	Inspection area figure0 Rectangle Lower right position X	figArea0_fig0_box_X1	Set/Get	-99,999 to 99,999
90,017	Inspection area figure0 Rectangle Lower right position Y	figArea0_fig0_box_Y1	Set/Get	-99,999 to 99,999
90,018	Inspection area figure0 Ellipse Center Position X	figArea0_fig0_ellipse_CX	Set/Get	-99,999 to 99,999
90,019	Inspection area figure0 Ellipse Center Position Y	figArea0_fig0_ellipse_CY	Set/Get	-99,999 to 99,999
90,020	Inspection area figure0 Ellipse RadiusX	figArea0_fig0_ellipse_RX	Set/Get	1 to 99,999
90,021	Inspection area figure0 Ellipse RadiusY	figArea0_fig0_ellipse_RY	Set/Get	1 to 99,999

No.	Data name	Data ident	Set/Get	Data range
90,025	Inspection area figure0 Circumference Center Position X	figArea0_fig0_circleW_X	Set/Get	-99,999 to 99,999
90,026	Inspection area figure0 Circumference Center Position Y	figArea0_fig0_circleW_Y	Set/Get	-99,999 to 99,999
90,027	Inspection area figure0 Circumference Radius	figArea0_fig0_circleW_R	Set/Get	0 to 99,999
90,028	Inspection area figure0 Circumference Width	figArea0_fig0_circleW_W	Set/Get	0 to 99,999
90,034	Inspection area figure0 Wide arc Center Position X	figArea0_fig0_arcW_X	Set/Get	-99,999 to 99,999
90,035	Inspection area figure0 Wide arc Center Position Y	figArea0_fig0_arcW_Y	Set/Get	-99,999 to 99,999
90,036	Inspection area figure0 Wide arc Radius	figArea0_fig0_arcW_R	Set/Get	0 to 99,999
90,037	Inspection area figure0 Wide arc Start angle	figArea0_fig0_arcW_SA	Set/Get	-180 to 180
90,038	Inspection area figure0 Wide arc End angle	figArea0_fig0_arcW_EA	Set/Get	-180 to 180
90,039	Inspection area figure0 Wide arc Width	figArea0_fig0_arcW_W	Set/Get	0 to 99,999
90,040	Inspection area figure0 Polygon Point Count	figArea0_fig0_polygon_count	Set/Get	3 to 10
90,041	Inspection area figure0 Polygon Point1 Position X	figArea0_fig0_polygon_x0	Set/Get	-99,999 to 99,999
90,042	Inspection area figure0 Polygon Point1 Position Y	figArea0_fig0_polygon_y0	Set/Get	-99,999 to 99,999
90,059	Inspection area figure0 Polygon Point10 Position X	figArea0_fig0_polygon_x9	Set/Get	-99,999 to 99,999
90,060	Inspection area figure0 Polygon Point10 Position Y	figArea0_fig0_polygon_y9	Set/Get	-99,999 to 99,999
90,099	Inspection area figure Update	figArea0_update	Set only	1: Update
90,101	Inspection area figure1 Type	figArea0_fig1_type	Set/Get	4: Wide line, 8: Rectangle, 16: Ellipse, 64: Circumference, 256: Wide arc, 512: Polygon
:	:	:	:	:

No.	Data name	Data ident	Set/Get	Data range
90,201	Inspection area figure2 Type	figArea0_fig2_type	Set/Get	4: Wide line, 8: Rectangle, 16: Ellipse, 64: Circumference, 256: Wide arc, 512: Polygon
:	:	:	:	:
90,301	Inspection area figure3 Type	figArea0_fig3_type	Set/Get	4: Wide line, 8: Rectangle, 16: Ellipse, 64: Circumference, 256: Wide arc, 512: Polygon
:	:	:	:	:
90,401	Inspection area figure4 Type	figArea0_fig4_type	Set/Get	4: Wide line, 8: Rectangle, 16: Ellipse, 64: Circumference, 256: Wide arc, 512: Polygon
:	:	:	:	:
90,501	Inspection area figure5 Type	figArea0_fig5_type	Set/Get	4: Wide line, 8: Rectangle, 16: Ellipse, 64: Circumference, 256: Wide arc, 512: Polygon
:	:	:	:	:
90,601	Inspection area figure6 Type	figArea0_fig6_type	Set/Get	4: Wide line, 8: Rectangle, 16: Ellipse, 64: Circumference, 256: Wide arc, 512: Polygon
:	:	:	:	:
90,701	Inspection area figure7 Type	figArea0_fig7_type	Set/Get	4: Wide line, 8: Rectangle, 16: Ellipse, 64: Circumference, 256: Wide arc, 512: Polygon
:	:	:	:	:
91,000	Mask area figure Count	figArea1_count	Set/Get	1
91,001	Mask area figure0 Type	figArea1_fig0_type	Set/Get	8: Rectangle
91,002	Mask area figure0 mode	figArea1_fig0_mode	Set/Get	0: OR
91,014	Mask area figure0 Rectangle Upper left position X	figArea1_fig0_box_X0	Set/Get	-99,999 to 99,999
91,015	Mask area figure0 Rectangle Upper left position Y	figArea1_fig0_box_Y0	Set/Get	-99,999 to 99,999
91,016	Mask area figure0 Rectangle Lower right position X	figArea1_fig0_box_X1	Set/Get	-99,999 to 99,999
91,017	Mask area figure0 Rectangle Lower right position Y	figArea1_fig0_box_Y1	Set/Get	-99,999 to 99,999
91,099	Mask area figure Update	figArea1_update	Set only	1: Update

No.	Data name	Data ident	Set/Get	Data range
92,000	Selected area figure Count	figArea2_count	Set/Get	0 to 8
92,001	Selected area figure0 Type	figArea2_fig0_type	Set/Get	8: Rectangle
92,002	Selected area figure0 mode	figArea2_fig0_mode	Set/Get	0: OR, 1: NOT
92,014	Selected area figure0 Rectangle Upper left position X	figArea2_fig0_box_X0	Set/Get	-99,999 to 99,999
92,015	Selected area figure0 Rectangle Upper left position Y	figArea2_fig0_box_Y0	Set/Get	-99,999 to 99,999
92,016	Selected area figure0 Rectangle Lower right position X	figArea2_fig0_box_X1	Set/Get	-99,999 to 99,999
92,017	Selected area figure0 Rectangle Lower right position Y	figArea2_fig0_box_Y1	Set/Get	-99,999 to 99,999
92,099	Selected area figure Update	figArea2_update	Set only	1: Update
92,101	Selected area figure1 Type	figArea2_fig1_type	Set/Get	8: Rectangle
:	:	:	:	:
92,201	Selected area figure2 Type	figArea2_fig2_type	Set/Get	8: Rectangle
:	:	:	:	:
92,301	Selected area figure3 Type	figArea2_fig3_type	Set/Get	8: Rectangle
:	:	:	:	:
92,401	Selected area figure4 Type	figArea2_fig4_type	Set/Get	8: Rectangle
:	:	:	:	:
92,501	Selected area figure5 Type	figArea2_fig5_type	Set/Get	8: Rectangle
:	:	:	:	:
92,601	Selected area figure6 Type	figArea2_fig6_type	Set/Get	8: Rectangle
:	:	:	:	:
92,701	Selected area figure7 Type	figArea2_fig7_type	Set/Get	8: Rectangle
:	:	:	:	:
92,717	Selected area figure7 Rectangle Lower right position Y	figArea2_fig7_box_Y1	Set/Get	-99,999 to 99,999

2-24 Precise Defect

Defects and contamination on plain measurement objects can be detected with high precision by performing differential processing on the image. By changing the size of elements used for detection, comparison intervals, etc., fine customization of speed and precision is possible.

Used in the Following Case

- Detecting defects, contaminations and spots on plain measurement objects:

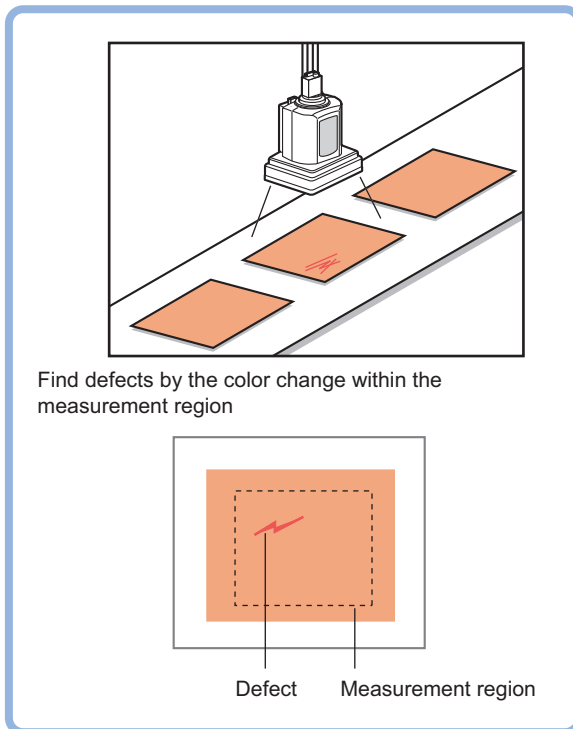

- Measure appearance defects and defects of parts:

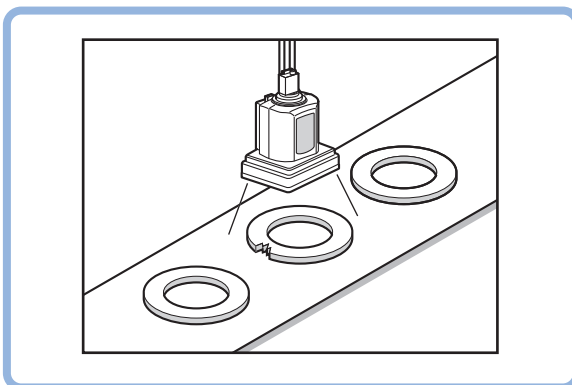

Precautions for Correct Use

Processing is different for color images and monochrome images. When the camera type used in the previous setup was changed to color or monochrome type, perform the settings again.

2-24-1 Settings Flow (Precise Defect)

To set Precise Defect, follow the steps below.

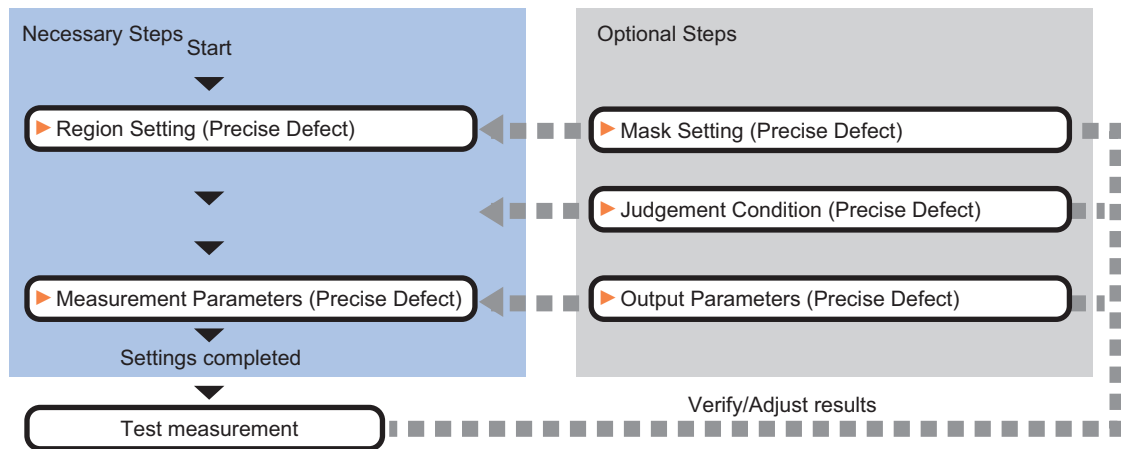

List of Precise Defect Items

Item	Description
Region setting	Sets the measurement area. It is possible to target the entire screen, but restricting the range can shorten the processing time. <i>2-24-2 Region Setting (Precise Defect) on page 2-365</i>
Mask setting	Set it when masking a region. The measurement result of another processing item can also be used for masking. <i>2-24-3 Mask Setting (Precise Defect) on page 2-367</i>
Measurement parameter	Measurement parameter can be changed as needed to address unstable measurement results. Normally, the factory default value will be used. <i>2-24-4 Measurement Parameters (Precise Defect) on page 2-370</i>
Judgment condition	This item is changed as necessary. Sets processing conditions for measurement and judgment conditions for measurement results. <i>2-24-5 Judgement Condition (Precise Defect) on page 2-373</i>
Output parameter	This item can be changed as necessary. Normally, the factory default value will be used. Use the output parameter to specify how to handle the coordinates. <i>2-24-6 Output parameter (Precise Defect) on page 2-374</i>

2-24-2 Region Setting (Precise Defect)

This item is used to set up the measurement area.

Use a rectangle, wide line, ellipse (circle), wide circle, wide arc or polygon to specify a measurement region for *Precise Defect*. Up to 8 figures can be drawn.



Precautions for Correct Use

A mask cannot be made with only one region specified using *Wide line*, *Wide circle*, or *Arc*, as the figure.

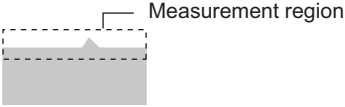
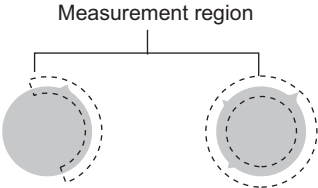
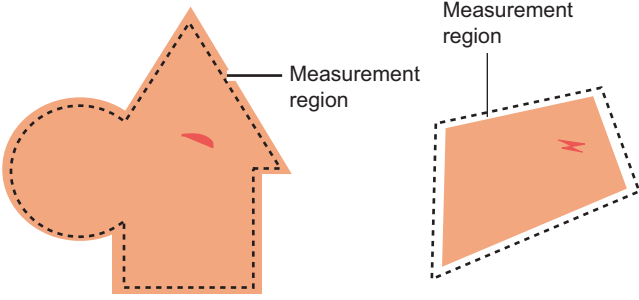
PT	Description
Wide line	<p>Selected when detecting defects and burrs of the measurement objects.</p> 
Wide circle, wide arc	<p>Selected when detecting defects and burrs of the circle measurement objects.</p> 
Rectangle, ellipse (circle), polygon	<p>Selected when detecting the overall defects of specified zones and measurement objects.</p> 



Additional Information

In Precise Defect, the measurement mode depends on the number and type of registered region figures. The method for creating elements differs depending on the measurement mode. Refer to *Additional Information: Measurement mode on 2-24-4 Measurement Parameters (Precise Defect)* on page 2-370

- 1** In the Item tab area, click **Region setting**.
- 2** Use the drawing tools to set the measurement region.
Up to 8 figures can be combined.
- 3** Click **OK** in the *Figure setting* area.
 - **OK**: Changes the settings and returns to the previous menu.
 - **Cancel**: Changes are discarded. Returns to the previous menu.
 - **Apply**: Updates the settings without leaving edit window.
- 4** When performing measurement in region mode for wide line, wide circle or arc in a single figure, check **Area** in the **Measure Mode** area.

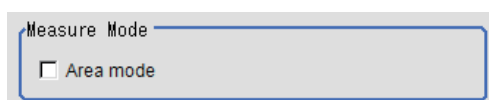

2-24-3 Mask Setting (Precise Defect)

Mask the measurement region when measuring it.

There are two types of masks, namely, a static mask that sets the mask region independent of measurement and a dynamic mask that uses images generated in another unit for each measurement



Precautions for Correct Use

A mask cannot be made with only one region specified using *Wide line*, *Wide circle*, or *Arc*, as the figure.

Creating a static mask

A static mask can be created manually or from an image of another unit.

- 1 In the *Mask setting* area, select *Static mask*.

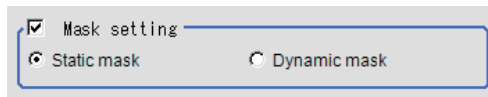

● Generating a mask manually

- 1 In the *Static mask set* area, select *Region extract*.

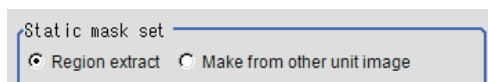

- 2 Select the selection region type OR or NOT and drag an image directly.
A region is created along successive similar colors from the selected place. It is not masked if the selection region type is OR.
It is masked if the selection region type is NOT.
To deselect a selected region, click **Undo**.
To edit a region selected with OR/NOT, click **Selected region edit**.

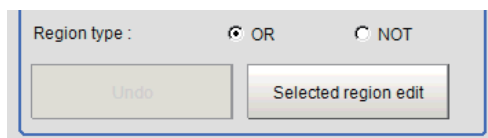

- 3 Adjust the mask created in the *Static mask setting* area.

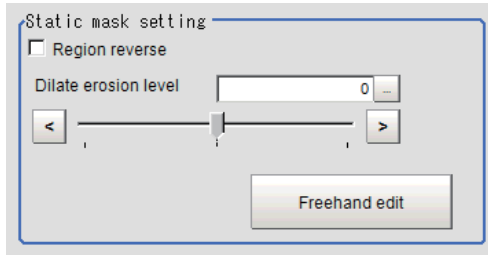

Setting item	Setting value [Factory default]	Description
Region reverse	<ul style="list-style-type: none"> • Checked • [Unchecked] 	Place a check to revert the created mask region.
Dilate erosion level	-10 to 10 [0]	Perform fine adjustment on the mask region using expansions/shrinkage. The region is expanded if a positive value is set. The region is shrunk if a negative value is set.

● Creating a static mask from an image of another unit

- 1 In the *Static mask set* area, select *Make from other unit image*.

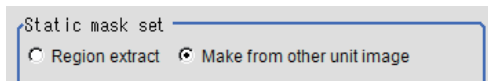

- 2 Set the unit number and image data number.

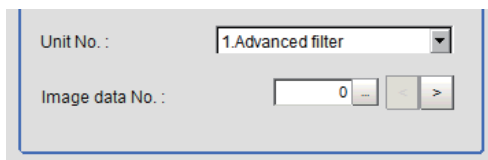

Setting item	Setting value [Factory default]	Description
Unit No.	-	Specify the number of the unit whose image will be referenced. The reference unit should be able to output binarized images. For example, select a labeling filter processing image for advanced filtering.
Image data No.	0 to 3 [0]	If the unit supports advanced filtering, numbers 0 to 3 can be set. Otherwise, it is fixed to 0.

Performing fine adjustment on a static mask

- 1 To perform fine adjustment on a mask region, click **Freehand edit** in the *Static mask setting* area.

Setting item	Setting value [Factory default]	Description
Freehand edit	<ul style="list-style-type: none"> [Mask add] Mask remove 	Select a process performed using the free hand edit.
Dot size	1 to 20 [1]	Set the size of dots used when drawing images on the screen.

- 2 Click **Return** to exit the free hand edit.

Clearing the static mask setting

- 1 To clear the static mask setting, click **Clear**.

Creating a dynamic mask

- 1 In the *Mask setting* area, select *Dynamic mask*.

- 2 Set the unit number and image data number in the *Unit reference* area.

Setting item	Setting value [Factory default]	Description
Unit No.	-	Set the number of the unit being referred to for the mask region. The reference unit should be able to output binarized images. For example, select a labeling filter processing image for advanced filtering.
Image data No.	0 to 3 [0]	If the unit supports advanced filtering, numbers 0 to 3 can be set. Otherwise, it is fixed to 0.

Setting display

Perform the display setting if required.

Show setting

Image type :

Mask region color :

Setting item	Setting value [Factory default]	Description
Image type	<ul style="list-style-type: none"> • Measure image • Mask binary image • [Mask and image] 	Select the type of an image to be displayed.
Mask region color	<ul style="list-style-type: none"> • [Black] • White • Red • Green • Blue 	Select the display color of the mask region. A part of color which is specified in <i>Mask region color</i> is not measured.

2-24-4 Measurement Parameters (Precise Defect)

This item specifies the judgement condition for measurement results. Measurement parameters can be changed as needed to address unstable measurement results or to increase the processing speed.



Additional Information

Measurement mode

In Precise Defect measurement, the measurement mode depends on the number of registered region figures and their types. The way to make elements depends on the measurement mode. The relationship between the figure and measurement mode is as in the table below.

	Single figure						Multiple figures
	Line	Circumference	Arc	Ellipse	Rectangle	Polygon	
Measurement mode	Line	Wide circle and arc		Region			

- **Line mode:**
The direction parallel to the measurement region straight line is the X axis and the direction perpendicular is the Y axis. The shape of elements is rectangular. The element width and length are the number of pixels specified with the element size X and Y.
- **Wide circle and arc mode:**
The circumferential direction along the measurement region wide circle (arc) is the X axis and the radial direction is the Y axis. The shape of elements is fan-shaped. If the circumference length of the wide circle (arc) of the measurement region is set to N, the element circumferential direction width is $360 \text{ degrees} \times \frac{\text{element size X}}{N}$. The element radial direction width is the number of pixels specified with the element size Y. The element circumferential direction width is defined as an angle, so the closer the element to the outer circumference, the larger the element.
- **Region mode:**
The direction parallel to the measurement region is the X axis and the direction perpendicular is the Y axis. The shape of elements is rectangular. The element width and length are the number of pixels specified with the element size X and Y.

1 In the Item tab area, click **Measurement**.

2 Set the detection parameters.

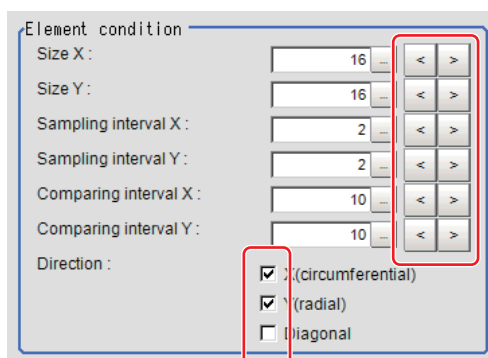

Setting item	Setting value [Factory default]	Description
Size X	4 to 64 [16]	Specifies the X-axis size of defects/contamination to be detected. The higher this value, the higher the degree of defects for large defects. Specify in units of pixels.
Size Y	4 to 64 [16]	Specifies the Y-axis size of defects/contamination to be detected. The higher this value, the higher the degree of defects for large defects. Specify in units of pixels.

Setting item	Setting value [Factory default]	Description
Sampling interval X	1 to 64 [2]	Specifies the interval for creating elements along the X axis. The smaller this value, the greater the defect detection performance, but the slower the processing speed. Specify in units of pixels.
Sampling interval Y	1 to 64 [2]	Specifies the interval for creating elements along the Y axis. The smaller this value, the greater the defect detection performance, but the slower the processing speed. Specify in units of pixels.
Comparing interval X	1 to 32 [10]	Sets the number of neighboring elements compared with when the degree of defect is calculated, For example, if the sampling interval is set to 4 and the comparing interval is set to 2, comparison is with separate elements of $4 \times 2 = 8$ pixels along the axis.
Comparing interval Y	1 to 32 [10]	Sets the number of neighboring elements compared with when the degree of defect is calculated, For example, if the sampling interval is set to 4 and the comparing interval is set to 2, comparison is with separate elements of $4 \times 2 = 8$ pixels along the axis.
Detection	<ul style="list-style-type: none"> • X (circumferential) • Y (radial) • Diagonal 	Sets the direction for detecting defects. The smaller the direction setting count, the shorter the processing time.

3 If necessary, set the value of each item in the *Measurement condition* area.

For color cameras:

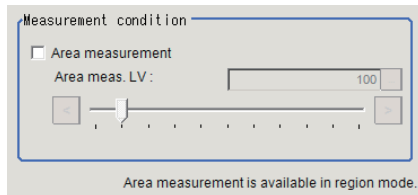

For monochrome cameras:

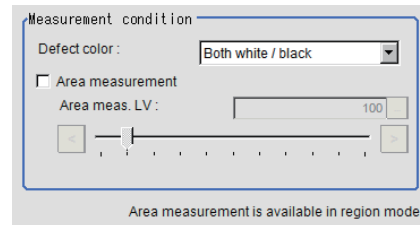

Setting item	Setting value [Factory default]	Description
Detect color (only for monochrome camera)	<ul style="list-style-type: none"> • White • Black • [White and Black] 	<ul style="list-style-type: none"> • Black: Selects this when detecting defects looking darker than the background. • White: Selects this when detecting defects looking brighter than the background. • White and Black: Selects this when the brightness of defects are not identified.
Area measurement	<ul style="list-style-type: none"> • Checked • [Unchecked] 	Places a check when you want to measure the size of defects. This item can divide the high defect detection regions into groups and output the surface and center of gravity coordinates of the group with the largest area. However, when only one region is specified with <i>Wide line</i> , <i>Wide circle</i> , or <i>Arc</i> , area measurement is not possible. However, if <i>Area mode</i> is checked, Area measurement can be performed with only one of the above figures.

Setting item	Setting value [Factory default]	Description
Area defect level	0 to 999 [100]	If you place a check at Area Measurement , set defect level counted in the defect area.

2-24-5 Judgement Condition (Precise Defect)

This item specifies the judgement condition for measurement results.

- 1 In the Item tab area, click **Judgment condition**.
- 2 When the setting has been changed, click **Measure** in the *Detail* area to verify whether measurements can be made correctly.

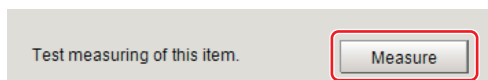

- 3 Set up the judgement condition.
Area judge and **Defect Number** are allowable only when you check the *Area measurement* in **Measurement parameter**.

Setting item	Setting value	Description
Defect judgment	0 to 999	Specifies the range of defect judgment values that are judged to be OK.
Area judgment	0 to 999,999,999.9999 0 to 307,200 (for a 0.3-megapixel camera) 0 to 1,920,000 (for a 2-megapixel camera) 0 to 4,320,000 (for a 5-megapixel camera)	Specifies the range of area judgment values that are judged to be OK.
Defect number	0 to 2,500	Specifies the range of the number of defects that are judged to be OK.

- 4 If necessary, set the display conditions for displayed images.

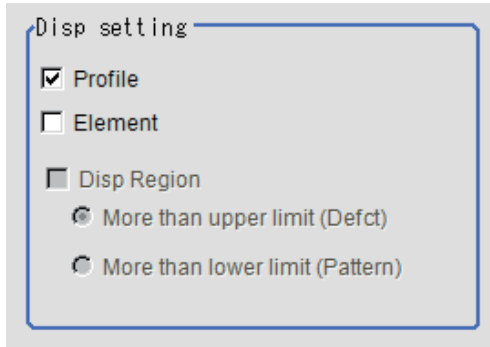

Setting item	Setting value [Factory default]	Description
Profile display	<ul style="list-style-type: none"> • [Checked] • Unchecked 	<p>Sets the profile display.</p> <p>The maximum degree of defect along the X(circumferential) and Y(radial) is displayed with red lines.</p> <p>If you click in the measurement region on the image area, the profile in the XY directions from this point is displayed with yellow lines.</p>
Element	<ul style="list-style-type: none"> • Checked • [Unchecked] 	<p>Sets the comparison element display.</p> <p>Elements are created automatically during measurement. The density is calculated for each element and the position of defects/contamination is detected from the degree of their variation.</p>
Disp Region	<ul style="list-style-type: none"> • [Checked] • Unchecked 	<p>Places a check to display the defect area.</p> <p>If checked, specify <i>More than upper limit (Defect)</i> or <i>More than lower limit (Pattern)</i>.</p>

2-24-6 Output parameter (Precise Defect)

Select whether or not to reflect the judgment results of this processing unit to the overall judgment of the scene.

- 1** In the Item tab area, click **Output parameter**.
- 2** Select whether or not to reflect it to the overall judgment in *Reflect to overall judgement* area.

Setting item	Setting value [Factory default]	Description
Reflect to overall judgment	<ul style="list-style-type: none"> [ON] OFF 	Enables choosing whether or not the judgement results of this processing unit is reflected in the scene overall judgment.

2-24-7 Key Points for Test Measurement and Adjustment (Precise Defect)

The following content is displayed in the *Detail result* area as text.

Displayed item	Description
Judge	Judgment results 0: No judgment (unmeasured) 1: Judgment result OK -1: Judgment result NG -10: Error (image format mismatch) -11: Error (unregistered model) -12: Error (insufficient memory) -20: Error (other errors)
Defect	Measured defect level
Defect coordinate X	X Coordinate of measured defect position
Defect coordinate Y	Y coordinate of measured defect position
Defect area	The measured maximum defect area
Defect area gravity X	The center of gravity X coordinates of the measured maximum defect area
Defect area gravity Y	The center of gravity Y coordinates of the measured maximum defect area
Defect count	Number of measured defects

The image specified in the Sub-image number in the image display setting is displayed in the *Image Display* area.

Sub-image number	Description of image to be displayed
0	Measurement image
1	Defect profile [when area measurement is present] If the region display is enabled, the defect area display image specified [when no area measurement].



Precautions for Correct Use

When displaying an image with the setting of sub-image number 1, the processing time will be longer. If you want to shorten the measurement interval, set the sub-image number to 0.

Key Points for Adjustment (Precise Defect)

Adjust the setting parameters referring to the following points.

● **When noise is detected as defects**

Parameter to be adjusted	Remedy
Measurement parameter	Specify a larger value for <i>Defect judgement</i> in the judgement conditions.

● **When judgement will be NG**

Parameter to be adjusted	Remedy
Measurement parameter	Make the measurement region larger than the value of the element size.

● **When the processing speed is slow**

Parameter to be adjusted	Remedy
Measurement parameter	Specify a larger value for the element creation interval.

2-24-8 Measurement Results for Which Output Is Possible (Precise Defect)

The following values can be output using processing items related to result output. It is also possible to reference measurement values from calculation expressions and other processing units.

Measurement items	Character string	Description
Judge	JG	Judgment results 0: No judgment (unmeasured) 1: Judgment result OK -1: Judgment result NG -10: Error (image format mismatch) -11: Error (unregistered model) -12: Error (insufficient memory) -20: Error (other errors)
Defect	F	Measured defect level
Defect coordinate X	X	X Coordinate of measured defect position
Defect coordinate Y	Y	Y coordinate of measured defect position
Defect area	AR	The measured maximum defect area
Defect area gravity X	GX	The center of gravity X coordinates of the measured maximum defect area
Defect area gravity Y	GY	The center of gravity Y coordinates of the measured maximum defect area
Defect count	NM	Number of measured defects

2-24-9 External Reference Tables (Precise Defect)

No.	Data name	Data ident	Set/Get	Data range
0	Judge	judge	Get only	0: No judgment (unmeasured), 1: Judgment result OK, -1: Judgment result NG, -10: Error (image format mismatch), -11: Error (unregistered model), -12: Error (insufficient memory), -20: Error (other errors)
5	Defect	defect	Get only	0 to 999
6	Position X	defectX	Get only	0 to 999,999,999.9999
7	Position Y	defectY	Get only	0 to 999,999,999.9999
8	Area	area	Get only	0 to 999,999,999.9999
9	Gravity X	gravityX	Get only	0 to 999,999,999.9999
10	Gravity Y	gravityY	Get only	0 to 999,999,999.9999
11	Defect number	defectNum	Get only	0 to 2,500
103	Reflect to overall judgement	overallJudge	Set/Get	0: ON, 1: OFF
120	Size X	xElmSize	Set/Get	4 to 64
121	Size Y	yElmSize	Set/Get	4 to 64
122	Sampling interval X	xElmPitch	Set/Get	1 to 64
123	Sampling interval Y	yElmPitch	Set/Get	1 to 64
124	Comparing interval X	xCompPitch	Set/Get	1 to 32
125	Comparing interval Y	yCompPitch	Set/Get	1 to 32
126	Detection object color	color	Set/Get	0: Both white/black, 1: White, 2: Black
127	Defect detection direction X	directionX	Set/Get	0: OFF, 1: ON
128	Defect detection direction Y	directionY	Set/Get	0: OFF, 1: ON
129	Inclined defect detection direction	direction8	Set/Get	0: OFF, 1: ON
130	Upper limit of defect judgement value	criteriaValue	Set/Get	0 to 999
131	Area measurement	measArea	Set/Get	0: OFF, 1: ON
132	Area meas. LV	areaJudge	Set/Get	0 to 999
133	Upper limit of area judgement	upperArea	Set/Get	0 to 999,999,999.9999
134	Profile display	dispProfile	Set/Get	0: OFF, 1: ON
135	Element display	dispElement	Set/Get	0: OFF, 1: ON
136	Lower limit of area judgement	lowerArea	Set/Get	0 to 999,999,999.9999
137	Lower limit of defect judgement value	lowerCriteriaValue	Set/Get	0 to 999
138	Area mode	checkMode	Set/Get	0: OFF, 1: ON
139	Region display	dispRegion	Set/Get	0: OFF, 1: ON
140	Defect number Lower Judge	lowerNum	Set/Get	0 to 2,500

No.	Data name	Data ident	Set/Get	Data range
141	Defect number Upper Judge	upperNum	Set/Get	0 to 2,500
142	Display defect kind	dispDefectKind	Set/Get	0: More than upper limit (Defct) 1: More than lower limit (Pattern)
155	Dynamic mask unit reference no	dynUnitNo	Set/Get	-1 to 9,999
156	Dynamic mask image no	dynImageNo	Set/Get	0 to 99
158	Display image type	chkChoose	Set/Get	0: Measure image, 1: Mask binary image, 2: Mask and image
164	Mask region display color	maskRegionColor	Set/Get	0: Black, 1: White, 2: Red, 3: Green, 4: Blue
6,002	Format	cameraColor	Set/Get	1: Monochrome camera 2: Color camera
10,000+N×3 (N=0 to 2,499)	Gravity X	gravityX0000 to gravityX2499	Get only	0 to 999,999,999.9999
10,001+N×3 (N=0 to 2,499)	Gravity Y	gravityY0000 to gravityY2499	Get only	0 to 999,999,999.9999
10,002+N×3 (N=0 to 2,499)	Area	area000 to area2499	Get only	0 to 999,999,999.9999
90,000	Inspection area figure Count	figArea0_count	Set/Get	0 to 8
90,001	Inspection area figure0 Type	figArea0_fig0_type	Set/Get	4: Wide line, 8: Rectangle, 16: Ellipse, 64: Circumference, 256: Wide arc, 512: Polygon
90,002	Inspection area figure0 mode	figArea0_fig0_mode	Set/Get	0: OR, 1: NOT
90,009	Inspection area figure0 Wide line Start point X	figArea0_fig0_lineW_X0	Set/Get	-99,999 to 99,999
90,010	Inspection area figure0 Wide line Start point Y	figArea0_fig0_lineW_Y0	Set/Get	-99,999 to 99,999
90,011	Inspection area figure0 Wide line End point X	figArea0_fig0_lineW_X1	Set/Get	-99,999 to 99,999
90,012	Inspection area figure0 Wide line End point Y	figArea0_fig0_lineW_Y1	Set/Get	-99,999 to 99,999
90,013	Inspection area figure0 Wide line Width	figArea0_fig0_lineW_W	Set/Get	0 to 99,999
90,014	Inspection area figure0 Rectangle Upper left position X	figArea0_fig0_box_X0	Set/Get	-99,999 to 99,999
90,015	Inspection area figure0 Rectangle Upper left position Y	figArea0_fig0_box_Y0	Set/Get	-99,999 to 99,999

No.	Data name	Data ident	Set/Get	Data range
90,016	Inspection area figure0 Rectangle Lower right position X	figArea0_fig0_box_X1	Set/Get	-99,999 to 99,999
90,017	Inspection area figure0 Rectangle Lower right position Y	figArea0_fig0_box_Y1	Set/Get	-99,999 to 99,999
90,018	Inspection area figure0 Ellipse Center Position X	figArea0_fig0_ellipse_CX	Set/Get	-99,999 to 99,999
90,019	Inspection area figure0 Ellipse Center Position Y	figArea0_fig0_ellipse_CY	Set/Get	-99,999 to 99,999
90,020	Inspection area figure0 Ellipse RadiusX	figArea0_fig0_ellipse_RX	Set/Get	1 to 99,999
90,021	Inspection area figure0 Ellipse RadiusY	figArea0_fig0_ellipse_RY	Set/Get	1 to 99,999
90,025	Inspection area figure0 Circumference Center Position X	figArea0_fig0_circleW_X	Set/Get	-99,999 to 99,999
90,026	Inspection area figure0 Circumference Center Position Y	figArea0_fig0_circleW_Y	Set/Get	-99,999 to 99,999
90,027	Inspection area figure0 Circumference Radius	figArea0_fig0_circleW_R	Set/Get	0 to 99,999
90,028	Inspection area figure0 Circumference Width	figArea0_fig0_circleW_W	Set/Get	0 to 99,999
90,034	Inspection area figure0 Wide arc Center Position X	figArea0_fig0_arcW_X	Set/Get	-99,999 to 99,999
90,035	Inspection area figure0 Wide arc Center Position Y	figArea0_fig0_arcW_Y	Set/Get	-99,999 to 99,999
90,036	Inspection area figure0 Wide arc Radius	figArea0_fig0_arcW_R	Set/Get	0 to 99,999
90,037	Inspection area figure0 Wide arc Start angle	figArea0_fig0_arcW_SA	Set/Get	-180 to 180
90,038	Inspection area figure0 Wide arc End angle	figArea0_fig0_arcW_EA	Set/Get	-180 to 180
90,039	Inspection area figure0 Wide arc Width	figArea0_fig0_arcW_W	Set/Get	0 to 99,999
90,040	Inspection area figure0 Polygon Point Count	figArea0_fig0_polygon_count	Set/Get	3 to 10
90,041	Inspection area figure0 Polygon Point1 Position X	figArea0_fig0_polygon_x0	Set/Get	-99,999 to 99,999

No.	Data name	Data ident	Set/Get	Data range
90,042	Inspection area figure0 Polygon Point1 Position Y	figArea0_fig0_polygon_y0	Set/Get	-99,999 to 99,999
90,059	Inspection area figure0 Polygon Point10 Position X	figArea0_fig0_polygon_x9	Set/Get	-99,999 to 99,999
90,060	Inspection area figure0 Polygon Point10 Position Y	figArea0_fig0_polygon_y9	Set/Get	-99,999 to 99,999
90,099	Inspection area figure Update	figArea0_update	Set only	1: Update
90,101	Inspection area figure1 Type	figArea0_fig1_type	Set/Get	4: Wide line, 8: Rectangle, 16: Ellipse, 64: Circumference, 256: Wide arc, 512: Polygon
:	:	:	:	:
90,201	Inspection area figure2 Type	figArea0_fig2_type	Set/Get	4: Wide line, 8: Rectangle, 16: Ellipse, 64: Circumference, 256: Wide arc, 512: Polygon
:	:	:	:	:
90,301	Inspection area figure3 Type	figArea0_fig3_type	Set/Get	4: Wide line, 8: Rectangle, 16: Ellipse, 64: Circumference, 256: Wide arc, 512: Polygon
:	:	:	:	:
90,401	Inspection area figure4 Type	figArea0_fig4_type	Set/Get	4: Wide line, 8: Rectangle, 16: Ellipse, 64: Circumference, 256: Wide arc, 512: Polygon
:	:	:	:	:
90,501	Inspection area figure5 Type	figArea0_fig5_type	Set/Get	4: Wide line, 8: Rectangle, 16: Ellipse, 64: Circumference, 256: Wide arc, 512: Polygon
:	:	:	:	:
90,601	Inspection area figure6 Type	figArea0_fig6_type	Set/Get	4: Wide line, 8: Rectangle, 16: Ellipse, 64: Circumference, 256: Wide arc, 512: Polygon
:	:	:	:	:
90,701	Inspection area figure7 Type	figArea0_fig7_type	Set/Get	4: Wide line, 8: Rectangle, 16: Ellipse, 64: Circumference, 256: Wide arc, 512: Polygon
:	:	:	:	:
91,000	Mask area figure Count	figArea1_count	Set/Get	1
91,001	Mask area figure0 Type	figArea1_fig0_type	Set/Get	8: Rectangle

No.	Data name	Data ident	Set/Get	Data range
91,002	Mask area figure0 mode	figArea1_fig0_mode	Set/Get	0: OR
91,014	Mask area figure0 Rectangle Upper left position X	figAr- ea1_fig0_box_X0	Set/Get	-99,999 to 99,999
91,015	Mask area figure0 Rectangle Upper left position Y	figAr- ea1_fig0_box_Y0	Set/Get	-99,999 to 99,999
91,016	Mask area figure0 Rectangle Lower right position X	figAr- ea1_fig0_box_X1	Set/Get	-99,999 to 99,999
91,017	Mask area figure0 Rectangle Lower right position Y	figAr- ea1_fig0_box_Y1	Set/Get	-99,999 to 99,999
91,099	Mask area figure Update	figArea1_update	Set only	1: Update
92,000	Selected area figure Count	figArea2_count	Set/Get	0 to 8
92,001	Selected area figure0 Type	figArea2_fig0_type	Set/Get	8: Rectangle
92,002	Selected area figure0 mode	figArea2_fig0_mode	Set/Get	0: OR, 1: NOT
92,014	Selected area figure0 Rectangle Upper left position X	figAr- ea2_fig0_box_X0	Set/Get	-99,999 to 99,999
92,015	Selected area figure0 Rectangle Upper left position Y	figAr- ea2_fig0_box_Y0	Set/Get	-99,999 to 99,999
92,016	Selected area figure0 Rectangle Lower right position X	figAr- ea2_fig0_box_X1	Set/Get	-99,999 to 99,999
92,017	Selected area figure0 Rectangle Lower right position Y	figAr- ea2_fig0_box_Y1	Set/Get	-99,999 to 99,999
92,099	Selected area figure Update	figArea2_update	Set only	1: Update
92,101	Selected area figure1 Type	figArea2_fig1_type	Set/Get	8: Rectangle
:	:	:	:	:
92,201	Selected area figure2 Type	figArea2_fig2_type	Set/Get	8: Rectangle
:	:	:	:	:
92,301	Selected area figure3 Type	figArea2_fig3_type	Set/Get	8: Rectangle
:	:	:	:	:
92,401	Selected area figure4 Type	figArea2_fig4_type	Set/Get	8: Rectangle
:	:	:	:	:
92,501	Selected area figure5 Type	figArea2_fig5_type	Set/Get	8: Rectangle
:	:	:	:	:

No.	Data name	Data ident	Set/Get	Data range
92,601	Selected area figure6 Type	figArea2_fig6_type	Set/Get	8: Rectangle
:	:	:	:	:
92,701	Selected area figure7 Type	figArea2_fig7_type	Set/Get	8: Rectangle
:	:	:	:	:
92,717	Selected area figure7 Rectangle Lower right position Y	figArea2_fig7_box_Y1	Set/Get	-99,999 to 99,999

2-25 Fine Matching

Differences can be detected in a fast and highly precise way by overlapping registered fine images with input images (matching).

Used in the Following Case

To precisely detect trivial defects at the edges of text and patterns:

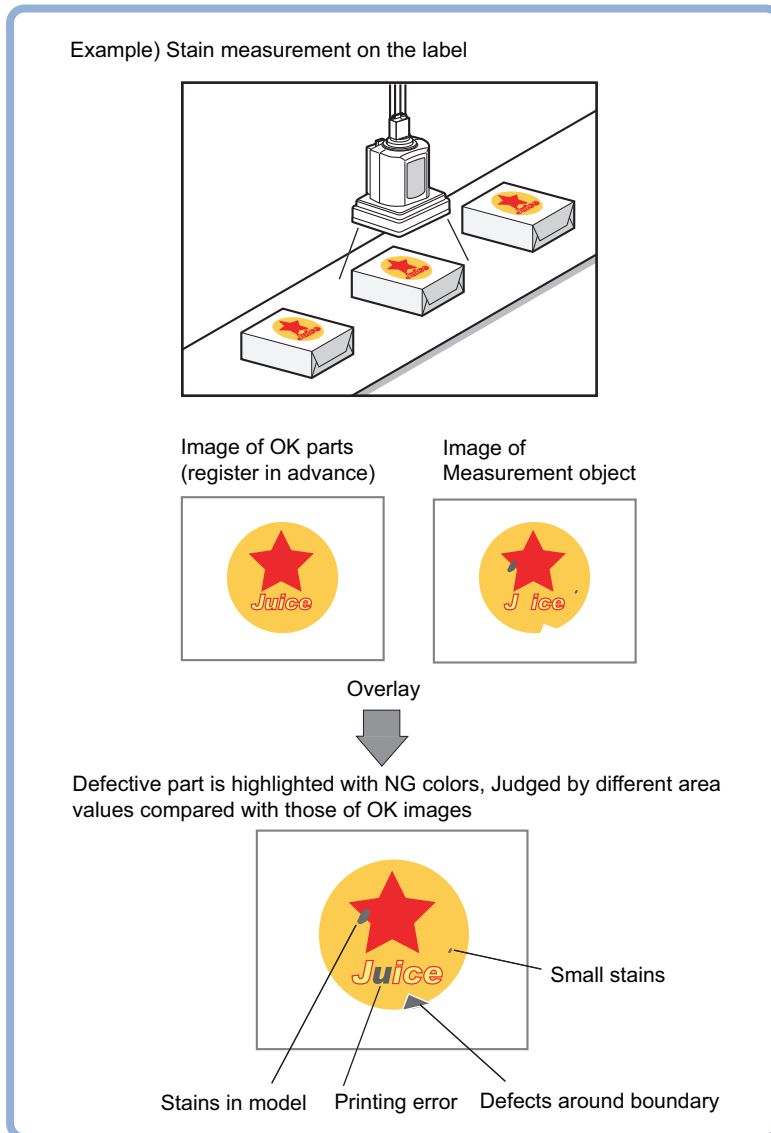

Precautions for Correct Use

Processing is different for color images and monochrome images. When the camera type used in the previous setup was changed to color or monochrome type, perform the settings again.

2-25-1 Settings Flow (Fine Matching)

To set Fine Matching, follow the steps below.

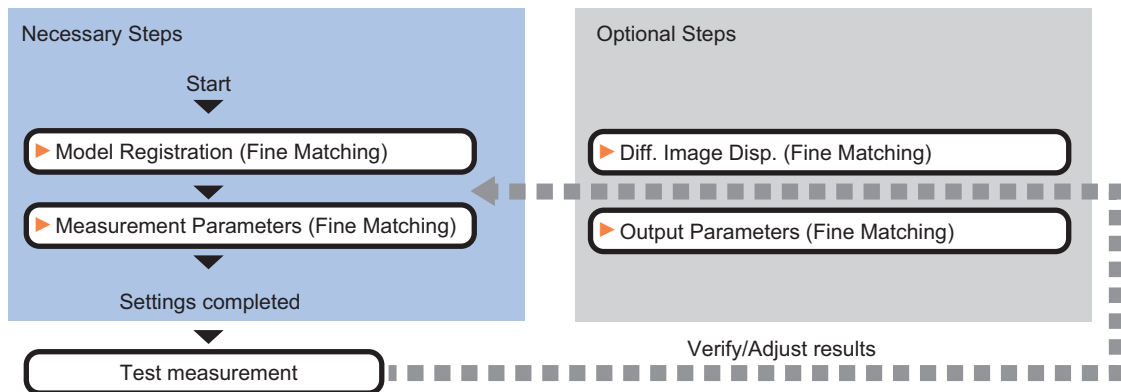

List of Fine Matching Items

Item	Description
Model	This item registers the pattern characteristic of the measurement image as a model. Model parameter values can be changed as needed to address unstable measurement results or to increase the processing speed. Normally, the factory default value will be used. <i>2-25-2 Model Registration (Fine Matching) on page 2-385</i>
Disp. image sub.	Modify this setting as necessary when defects cannot be detected successfully. This sets the reference grayscale used when calculating differences between the model and the inspected object image. Normally, the factory default value will be used. <i>2-25-3 Difference Image Display (Fine Matching) on page 2-387</i>
Measurement parameter	Sets processing conditions for measurement and judgment conditions for measurement results. Specify the criteria to judge the measurement result if the X and Y coordinates and the correlation with the model are OK. <i>2-25-4 Measurement Parameters (Fine Matching) on page 2-388</i>
Output parameter	This item can be changed as necessary. Normally, the factory default value will be used. Use the output parameter to specify how to handle the coordinates. <i>2-25-5 Output Parameters (Fine Matching) on page 2-391</i>



Additional Information

Specify *Boundary inspection* in **Model register** and *Inspection* in **Measurement** according to the inspection objectives.

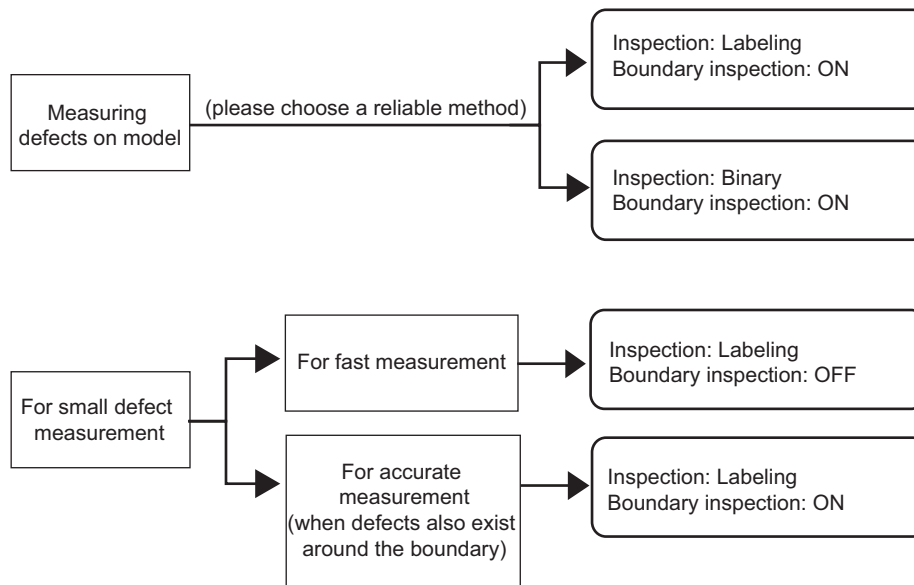

2-25-2 Model Registration (Fine Matching)

Register a fine image as the model. By matching this model with input images, unmatched parts will be detected as defects during inspection.



Additional Information

Ranges that can be registered as models:

- The two pixels on the edge of the screen are not registered as a model.
- The registering range will be lower if the images of measurement object are set with Filtering. When you set the image reading range using a camera with the partial scanning function, the range is also limited. Refer to Filtering.
- When figures are drawn overlapping, the settings for objects set up afterward are enabled. For details, refer to *Appendixes Setting Figures* in the *Vision System FH/FHV Series User's Manual (Cat. No. Z365)*.

- 1** In the Item tab area, click **Model**.
When setting a new model, you do not have to click **Model**.
- 2** Use the drawing tools to specify the model registration range.
- 3** Click **OK** in the *Figure setting* area.
 - **OK**: Changes the settings and returns to the previous menu.
 - **Cancel**: Changes are discarded. Returns to the previous menu.
 - **Apply**: Updates the settings without leaving edit window.

Changing Model Parameters

The range can be changed as needed to address unstable measurement results. Normally, the factory default value will be used.

After changing a setting, check whether measurement can be done properly by performing an actual measurement.

- 1 In the *Model parameter* area, specify a value for each item.

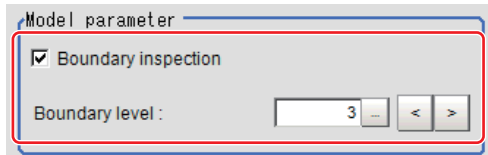

Setting item	Setting value [Factory default]	Description
Boundary inspection	<ul style="list-style-type: none"> • [Checked] • Unchecked 	<ul style="list-style-type: none"> • Checked: Defects around boundaries with color changes can also be detected. The edges similar to those in the model image are not regarded as defects. Check this option when inspecting defects around boundaries, such as chips and burrs. Defects along a direction different from the model image profile are detected in the range of pixels of profile \pm boundary level. • Unchecked: Boundary areas are excluded from the inspection. This can prevent matching mistakes due to positional deviation of measurement objects, but defects around boundaries cannot be detected. <i>Boundary level</i> can be used to specify how many pixels around boundaries should be excluded from the inspection. <div style="text-align: center;"> <p>Measurement image</p> </div>
Boundary level	0 to 9 [3]	Sets the degree of assimilation of variations around boundaries. The meaning varies depending on the <i>Boundary inspection</i> .



2-25-3 Difference Image Display (Fine Matching)

This sets the reference grayscale used when calculating differences between the model and the inspected object image. Modify this setting as necessary when defects cannot be detected successfully. Normally, the factory default value will be used.

After changing a setting, check whether measurement can be done properly by performing an actual measurement.

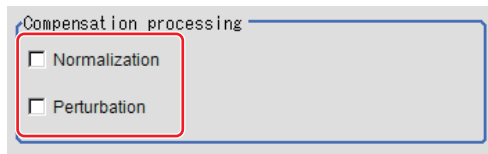

- 1 In the Item Tab area, click **Diff. image disp.**
- 2 In the *Compensation processing* area, select a value for each item.

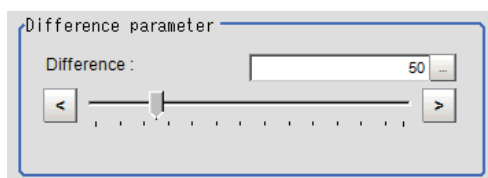

Setting item	Setting value [Factory default]	Description
Normalization	<ul style="list-style-type: none"> • Checked • [Unchecked] 	<p>Specifies whether to perform normalization based on the brightness in the registered model.</p> <p>When Normalization is checked, the density is adjusted before matching, so that the matching is not affected by changes in the total image brightness or the lighting fluctuations.</p> <p>When normalization is performed on the measured objects without patterns, the total image brightness is changed and the measurement does not work correctly.</p> <div style="text-align: center;"> <p>Model image</p>  <p>Measurement image (When the whole image turns dark)</p>  <p>Normalization processing →</p>  </div>
Perturbation	<ul style="list-style-type: none"> • Checked • [Unchecked] 	<p>If you place a check here, in order to prevent mistaken detection of slight positional deviation of measurement objects as differences, slight positional deviations are corrected before matching. However, this requires more processing time.</p>

- 3 Input the *Difference* in the *Difference parameter* area.



Setting item	Setting value [Factory default]	Description
Difference	0 to 255 [50]	<p>Sets the reference grayscale used for calculating differences between the model and inspection target images. Pixels with a difference equal to or greater than <i>Difference</i> are converted to white and other pixels are converted to black, so that only defects are converted to white and measured.</p> <div style="display: flex; justify-content: space-around; align-items: center;"> <div style="text-align: center;"> <p>Model Image</p>  </div> <div style="text-align: center;"> <p>Inspected object image</p>  </div> </div> <p style="text-align: center; margin: 10px 0;">↓</p> <div style="display: flex; justify-content: center; align-items: center;"> <div style="text-align: center;"> <p>Difference</p>  </div> <div style="margin-left: 20px;"> <p>Pixels with difference equals to or greater than Difference are white</p> <p>Other pixels (with smaller difference with the model) are black</p> <p>Adjust the parameter with an NG image displayed, so that you can refer to the difference image.</p> </div> </div>

2-25-4 Measurement Parameters (Fine Matching)

This item specifies the judgement conditions for measurement conditions and measurement results.

- 1 In the Item tab area, click **Measurement**.
- 2 Select *Inspection* in the *Measurement condition* area.

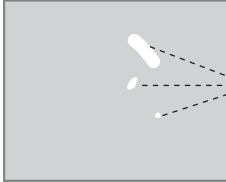
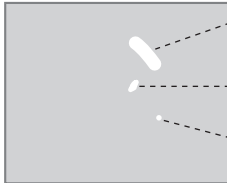

Setting item	Setting value [Factory default]	Description
Inspection	<ul style="list-style-type: none"> [Binary area] Labeling 	<p>Images that are different from the model will be converted into binary images internally. Inspection that is used to detect binary images should be selected.</p> <ul style="list-style-type: none"> Binary area Defect is judged based on the total area of white pixels.  <ul style="list-style-type: none"> Labeling A white pixel will be detected as 1 label, which is then compared with a label which is consistent with the set conditions to determine whether or not it is a defect. 

When *Labeling* is selected, the following items are set.

Setting item	Setting value [Factory default]	Description
Label No.	0 to 2,499 [0]	Specifies the label number used to determine whether defects exist. Different settings for <i>Sort condition</i> will lead to different number assignment.

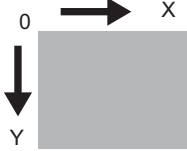
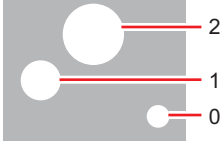
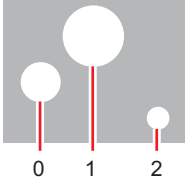
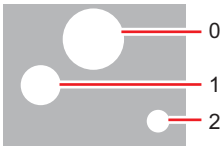
Setting item	Setting value [Factory default]	Description
Sort condition	<ul style="list-style-type: none"> • Area ascending • [Area descending] • X ascending • X descending • Y ascending • Y descending 	<p>Specifies the conditions by which label number is re-assigned.</p> <p>When sorting referencing the X and Y coordinates, the upper left is the origin. This will not affect the coordinate systems set up through the <i>Camera Image Input</i> calibration.</p>  <ul style="list-style-type: none"> • Area ascending: Number re-assigning begins from the labels with smaller areas.  <ul style="list-style-type: none"> • Area descending: Number re-assigning begins from labels with larger area. • X ascending: Number re-assigning begins from the label with a smaller gravity X coordinate.  <ul style="list-style-type: none"> • X descending: Number re-assigning begins from the label with a larger gravity X coordinate. • Y ascending: Number re-assigning begins from the label with a smaller gravity Y coordinate.  <ul style="list-style-type: none"> • Y descending: Number re-assigning begins from the label with a larger gravity Y coordinate.
Label area	0 to 999,999,999 [0] to [999,999,999]	Specifies the range of the area to be judged as a label.

3 When the setting has been changed, click **Measure** in the *Detail* area to verify whether measurements can be made correctly.

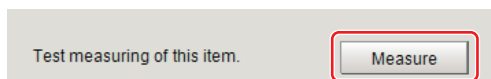

4 Set up the judgment condition.

Setting item	Setting value	Description
Quantity	0 to 9,999	Specifies the range of the number of labels that is judged to be OK. When <i>Binary area</i> is used, the white pixels as a whole will be regarded as one label.
Area	0 to 999,999,999.9999	Specifies the range of the area that is judged to be OK. When the <i>Labeling</i> is used, the area of the label number will be specified instead.
Defect pos X	-99,999.9999 to 99,999.9999	Specifies the X and Y axis move ranges for the center of gravity positions that are judged to be OK.
Defect pos Y	-99,999.9999 to 99,999.9999	When the <i>Labeling</i> is used, the center of gravity position of the label number will be specified instead.



Additional Information

Defect coordinates give the center of gravity position of detected defects.

2-25-5 Output Parameters (Fine Matching)

Specify how to treat the coordinates to be output to the external device as measurement results. This item can be changed if necessary. Normally, the factory default value will be used.



Precautions for Correct Use

After setting up the measurement parameters, changing the output parameters will cause measurement results to vary accordingly. If the output parameters have been changed, re-specify the measurement, too.

- 1 Click **Output parameter** in the Item tab area.
- 2 Specify each of the following items.

Setting item	Setting value [Factory default]	Description
Output coordinates	<ul style="list-style-type: none"> • [After scroll] • Before scroll 	As measurement results, select whether to output coordinate values to external devices before or after the position deflection correction is applied.
Calibration	<ul style="list-style-type: none"> • ON • [OFF] 	Select whether to reflect the calibration in the values output to the external device as measurement results. <ul style="list-style-type: none"> • ON: Output the coordinates converted into actual dimensions. • OFF: Output the camera coordinate values.
Reflect to overall judgment	<ul style="list-style-type: none"> • [ON] • OFF 	Enables choosing whether or not the judgement results of this processing unit is reflected in the scene overall judgment.



Additional Information

For output coordinates and calibration, refer to *Appendixes Measurement Mechanism Handling Coordinates* in the *Vision System FH/FHV Series User's Manual (Cat. No. Z365)*.

2-25-6 Key Points for Test Measurement and Adjustment (Fine Matching)

The following content is displayed in the *Detail result* area as text.

Displayed item	Description
Judge	Judgment results 0: No judgment (unmeasured) 1: Judgment result OK -1: Judgment result NG -10: Error (image format mismatch) -11: Error (unregistered model) -12: Error (insufficient memory) -20: Error (other errors)
Quantity	Number of defects
Area	Defect area
Defect coordinate X	X Coordinate of measured defect position
Defect coordinate Y	Y coordinate of measured defect position

The image specified in the Sub-image number in the image display setting is displayed in the *Image Display* area.

Sub-image number	Description of image to be displayed
0	Measurement image
1	Difference image

Key Points for Adjustment (Fine Matching)

Adjust the setting parameters referring to the following points.

● When non-existent defects are detected around the boundary

Parameter to be adjusted	Remedy
Model registration	Uncheck the <i>Boundary inspection</i> .
Measurement parameter	Set the <i>Labeling</i> as the <i>Inspection</i> .

● When noise is detected as defects / defects cannot be detected

Parameter to be adjusted	Remedy
Diff. image disp.	Adjust the <i>Difference</i> .

● When measurement object is near plain area

Parameter to be adjusted	Remedy
Diff. image disp.	Uncheck the <i>Normalization</i> .

- When the processing speed is slow

Parameter to be adjusted	Remedy
Model registration	Uncheck the <i>Boundary inspection</i> .
Measurement parameter	Set the <i>Labeling</i> as the <i>Inspection</i> .

2-25-7 Measurement Results for Which Output Is Possible (Fine Matching)

The following values can be output using processing items related to result output. It is also possible to reference measurement values from calculation expressions and other processing units.

Measurement items	Character string	Description
Judge	JG	Judgment results 0: No judgment (unmeasured) 1: Judgment result OK -1: Judgment result NG -10: Error (image format mismatch) -11: Error (unregistered model) -12: Error (insufficient memory) -20: Error (other errors)
Quantity	DA	No. of labeling
Area	AR	Area
Defect coordinate X	X	X Coordinate of measured defect position
Defect coordinate Y	Y	Y coordinate of measured defect position

2-25-8 External Reference Tables (Fine Matching)

No.	Data name	Data ident	Set/Get	Data range
0	Judge	judge	Get only	0: No judgment (unmeasured), 1: Judgment result OK, -1: Judgment result NG, -10: Error (image format mismatch), -11: Error (unregistered model), -12: Error (insufficient memory), -20: Error (other errors)
5	Number of labeling	numOfLabels	Get only	0 to 9,999
6	Area	areaValue	Get only	0 to 999,999,999.9999
7	Position X	defectX	Get only	-99,999.9999 to 99,999.9999
8	Position Y	defectY	Get only	-99,999.9999 to 99,999.9999
101	Output coordinates	outputCoordinate	Set/Get	0: After scroll 1: Before scroll
102	Calibration	calibration	Set/Get	0: OFF, 1: ON
103	Reflect to overall judgement	overallJudge	Set/Get	0: ON, 1: OFF
120	Boundary inspection	boundaryInspection	Set/Get	0: OFF, 1: ON
121	Boundary level	boundaryLevel	Set/Get	0 to 9

No.	Data name	Data ident	Set/Get	Data range
122	Normalization	normalization	Set/Get	0: OFF, 1: ON
123	Perturbation	perturbation	Set/Get	0: OFF, 1: ON
124	Difference	difference	Set/Get	0 to 255
125	Inspection	inspection	Set/Get	0: Binary, 1: Labeling
126	Label No.	labelNo	Set/Get	0 to 2,499
127	Sort condition	sortCondition	Set/Get	0: Area ascending, 1: Area descending, 2: X ascending, 3: X descending, 4: Y ascending, 5: Y descending
128	Upper limit of label area condition	upperLabelArea	Set/Get	0 to 999,999,999
129	Lower limit of label area condition	lowerLabelArea	Set/Get	0 to 999,999,999
130	Upper limit of quantity judgement	upperQuantity	Set/Get	0 to 9,999
131	Lower limit of quantity judgement	lowerQuantity	Set/Get	0 to 9,999
132	Upper limit of area judgement	upperArea	Set/Get	0 to 999,999,999.9999
133	Lower limit of area judgement	lowerArea	Set/Get	0 to 999,999,999.9999
134	Upper limit of position X	upperDefectX	Set/Get	-99,999.9999 to 99,999.9999
135	Lower limit of position X	lowerDefectX	Set/Get	-99,999.9999 to 99,999.9999
136	Upper limit of position Y	upperDefectY	Set/Get	-99,999.9999 to 99,999.9999
137	Lower limit of position Y	lowerDefectY	Set/Get	-99,999.9999 to 99,999.9999
6,002	Format	cameraColor	Set/Get	1: Monochrome camera 2: Color camera

2-26 Character Inspection

Using model images registered in a **Model Dictionary**, this processing item performs character recognition by correlation searches.



Precautions for Correct Use

The model dictionary needs to be created in advance.
Refer to *2-28 Model Dictionary* on page 2-421.

Used in the Following Case

When identifying standard character data (check of product model name):

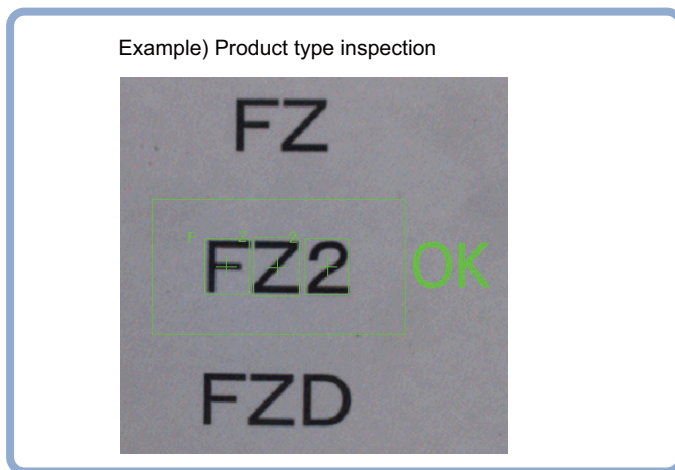

Precautions for Correct Use

Processing is different for color images and monochrome images. When the camera type used in the previous setup was changed to color or monochrome type, perform the settings again.

2-26-1 Settings Flow (Character Inspection)

To set Character Inspection, follow the steps below.

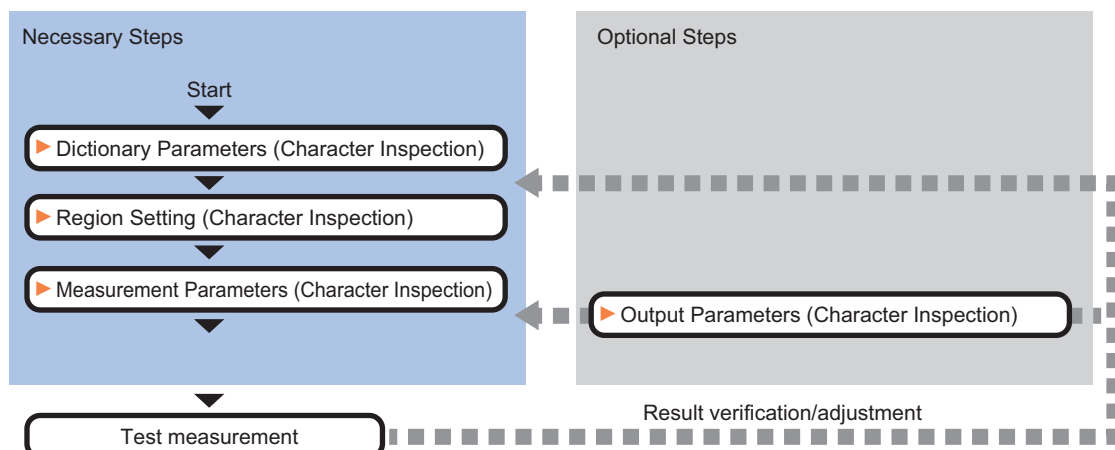

List of Character Inspection Items

Item	Description
Dictionary	This item specifies the processing unit number for the model dictionary to use for character recognition. <i>2-26-2 Dictionary Parameters (Character Inspection) on page 2-396</i>
Region setting	Sets the measurement area. It is possible to target the entire screen, but restricting the range can shorten the processing time. <i>2-26-3 Region Setting (Character Inspection) on page 2-397</i>
Measurement parameter	Sets processing conditions for measurement and judgment conditions for measurement results. Specify the criteria to judge the measurement result if the X and Y coordinates and the correlation with the model are OK. <i>2-26-4 Measurement Parameters (Character Inspection) on page 2-397</i>
Output parameter	This item can be changed as necessary. Normally, the factory default value will be used. Use the output parameter to specify how to handle the coordinates. <i>2-26-5 Output Parameters (Character Inspection) on page 2-399</i>

2-26-2 Dictionary Parameters (Character Inspection)

This item selects the processing unit number for the model dictionary to use for character inspection.

- 1 In the Item Tab area, click **Dictionary**.
- 2 In the *Dictionary unit* area, select the unit number.
A dictionary unit other than the currently used scene can also be used.

	Scene	Dictionary unit
1:	Current scene	<None>
2:	Current scene	<None>
3:	Current scene	<None>
4:	Current scene	<None>

- 3 If necessary, specify an index to use.
 - 1) Click ▼ and select the dictionary unit to be specified.
The following character strings are registered.
 - 2) Place a check at the character(s) to use for character inspection.
Click the **Enable all / Disable all** button to enable/disable all registered characters.

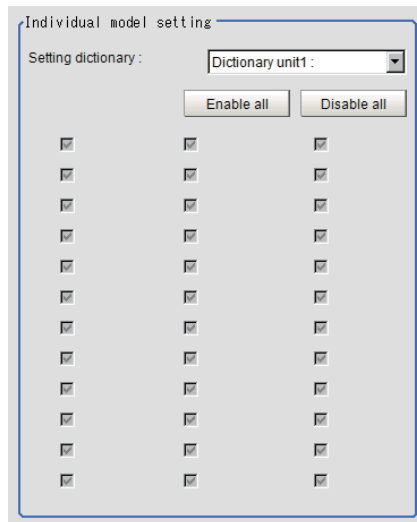

- 4 Click **OK**.
The model dictionary to use is set.

2-26-3 Region Setting (Character Inspection)

This item is used to set up the measurement area.

Instead of measuring the entire input image, narrowing the measurement area shortens the processing time.

This item specifies the measurement region of *Character Inspection* using a rectangle.



Additional Information

Number of characters that can be inspected:

Up to 32 characters can be inspected in the measurement region.

- 1 In the Item tab area, click **Region setting**.
- 2 Click **Edit**.
The *Figure Setting* area is displayed.
- 3 Specify the area in which to search for the model.
The rectangle covering the entire screen is set. Adjust the size and position of the rectangle.
- 4 Click **OK** in the *Figure setting* area.
 - **OK**: Changes the settings and returns to the previous menu.
 - **Cancel**: Changes are discarded. Returns to the previous menu.
 - **Apply**: Updates the settings without leaving edit window.

2-26-4 Measurement Parameters (Character Inspection)

Set the character inspection contents, the trimming method and the judgement conditions for the measurement results.

1 In the Item tab area, click **Measurement**.

2 In the Inspection condition area, specify a value for each item.

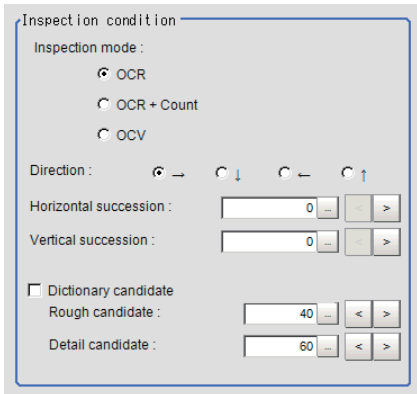

Setting item	Setting value [Factory default]	Description
Inspection mode	<ul style="list-style-type: none"> • [OCR] • OCR + Count • OCV 	Selects the inspection mode of characters. <ul style="list-style-type: none"> • OCR: The character string is read in. • OCR + Count: The character string is read in. Also, the number of characters is inspected. • OCV: Inspects whether or not the same characters are lined up as the preset correct character string combination.
Direction	<ul style="list-style-type: none"> • [→] • ↓ • ← • ↑ 	Specifies the direction of character reading.
Horizontal succession	0 to 99 [0]	If characters are too close together to read in well, set a larger value. Specify the allowable overlapping width possible to read models in the unit of pixel. This item is valid when <i>Direction</i> is →, ←.
Vertical succession	0 to 99 [0]	If characters are too close together to read in well, set a larger value. Specify the allowable overlapping width possible to read models in the unit of pixel. This item is valid when <i>Direction</i> is ↓, ↑.
Dictionary candidate	<ul style="list-style-type: none"> • Checked • [Unchecked] 	Specifies whether to use candidate point levels specified in the Model Dictionary or not. <ul style="list-style-type: none"> • Checked: Used • Unchecked: Not used
Rough candidate	0 to 100 [40]	When <i>Dictionary candidate</i> is unchecked, specify a value for the Rough candidate.
Detail candidate	0 to 100 [60]	When <i>Dictionary candidate</i> is unchecked, specify a value for the Detailed candidate.

3 Set up the judgement condition.

Setting item	Setting value [Factory default]	Description
Dictionary correlation	<ul style="list-style-type: none"> • Checked • [Unchecked] 	Specifies whether to use the correlation lower limit set in the Model Dictionary or not. <ul style="list-style-type: none"> • Checked: Used • Unchecked: Not used
Correlation	0 to 100 [60]	When Dictionary correlation is unchecked, specify the Correlation .
Lower limit of stability	0 to 100 [0]	The displayed stability value is the value obtained by subtracting the correlation value of the second candidate from the correlation value of the first candidate for the read character. The stability is low when the difference between the candidate correlation values is small, and there is a possibility that the character was misread. A stability higher than the lower limit of stability is OK.
Character count	1 to 32	When <i>Inspection mode</i> is <i>OCR + Count</i> , specify the judgment condition for the number of characters.
Verification string	A string with up to 32 characters. [None]	When <i>Inspection mode</i> is <i>OCV</i> , specify the Verification string. "*" in the Verification string is a wild card. Verification of whether a character is "*" is not possible. For sections to be judged OK no matter what characters are present and to just inspect whether or not there are characters at all, use "*".

2-26-5 Output Parameters (Character Inspection)

Select how measurement results are output to an external device. This item can be changed if necessary. Normally, the factory default value will be used.

- 1 Click **Output parameter** in the Item Tab area.
- 2 Specify a value for each item.

Setting item	Setting value [Factory default]	Description
Reflect to overall judgment	<ul style="list-style-type: none"> • [ON] • OFF 	Enables choosing whether or not the judgement results of this processing unit is reflected in the scene overall judgment.

Setting item		Setting value [Factory default]	Description
Character output	Character output	<ul style="list-style-type: none"> • Checked • [Unchecked] 	Specifies whether to output read-in character strings to an external device.
	Output device	<ul style="list-style-type: none"> • [RS-232C / RS-422] • Ethernet 	<p>When Character output is checked (output), this specifies the device to which strings are output. A character string is output as an ASCII code character string plus a delimiter. When kanji or other characters that are not ASCII codes are included, they are not output correctly.</p> <p>The output destination is Serial (RS-232C / 422) or Serial (Ethernet) selected in the Communication of the System Settings. The setting of the IP address of the serial (Ethernet) output destination also follows the System Settings.</p> <p>*1 For details, refer to <i>Non-procedure Communications</i> in the <i>Vision System FH/FHV Series User's Manual for Communications Settings (Cat. No. Z342)</i>.</p>

*1. RS-422 is unavailable in the FH/FHV series.



Additional Information

For character output, if there was no read character string, then the delimiter is output.

Output of Character String in PLC Link

In PLC Link communication, if you check the **Character output** in the **Output parameter** tab, the character string and NULL(00 hex)+NULL(00 hex) are output to the data output area of PLC Link.

● Output Format

Take the following case as an example. Number of measurement is one. Reading character string is 32. Command: Read character strings 0123456789...UV, Command, Response, and Data Output area are as follows.

For details, refer to *Communicating with PLC Link, Command Details for PLC Link, EtherNet/IP, and EtherCAT* in *Vision System FH/FHV Series User's Manual for Communications Settings (Cat. No. Z342)*.



Additional Information

If no character string, no data will be output.

- Command (PLC to Sensor Controller)

Command Area		Description
Top Channel +3	Top Channel +2	
0010	1010	Performs one measurement.

- Response (Sensor Controller to PLC)

Response Area		Description
Top Channel	Data	
+2	1010	Command Code: Target command code is responded.
+3	0010	
+4	0000	Response code: Command execution result.
+5	0000	

- Data Output Area (Sensor Controller to PLC)

When read the 32 character strings (0123456789...UV), the result continues as follows. ASCII code data + NULL (00 hex) + NULL (00 hex)

Top channel	Name	Description
+0	1st character, 2nd character	3031 (ASCII code of the character 0, ASCII code of the character 1)
+1	3rd character, 4th character	3233 (ASCII code of the character 2, ASCII code of the character 3)
:	:	:
+15	31st character, 32nd character	5556 (ASCII code of the character U, ASCII code of the character V)
+16	NULL, NULL	NULL (00 hex) + NULL (00 hex)

● How to get the character string

Perform the Data Output Request (DSA) and Data Output Completion (GATE) as in the case of Data Output.

All character string is included in one data. Thereby, Data Output Request (DSA) is performed once if there is one Character Inspection unit.

Output of Character String with Non-procedure Communications

Check the **Character output** in the **Output parameter** tab to output the character string with Non-procedure communication.

● Output Format

Take the following case as an example. Number of measurement is one. Reading character string is 32. Command: Read character strings 0123456789...UV, Command, Response, and Data Output area are as follows.

For details, refer to *Non-procedure Communications* and *MEASURE* or *M* in *Non-procedure Command Details* in *Vision System FH/FHV Series User's Manual for Communications Settings* (Cat. No. Z342).

- Command (PLC to Sensor Controller)

M E A S U R E ^{C_R} or M ^{C_R}

- Response (Sensor Controller to PLC)

O K ^{C_R}

0123456789...UV(Character string data) NULL(00 hex) ^{C_R}

Output of Character String with EtherNet/IP Message Communications

In EtherNet/IP message communication, output of character string is possible using UNITDATA command which acquires the measurement value. Outputs the character string data measured and NULL (00 hex).

For details, refer to *Communicating with the Sensor Controller with EtherNet/IP Message Communications, Non-procedure Communications and UNITDATA or UD in Non-procedure Command Details in Vision System FH/FHV Series User's Manual for Communications Settings (Cat. No. Z342)*.

● Output Format

Take the following case as an example. Number of measurement is one. Reading character string is 32. Command: Read character strings 0123456789...UV, Command, Response, and Data Output area are as follows. Described example is only a part of Attribute.



Additional Information

- When character strings in multiple lines are output, change the external reference table No. of UNITDATA, and then read the character strings.
- Command (PLC to Sensor Controller)
Specify the command character string equivalent to a non-procedure command.
Attach NULL(00 hex) at the end of the character string. No line feed code is required.
The size of the send data includes the NULL(00 hex) at the end of the character string.

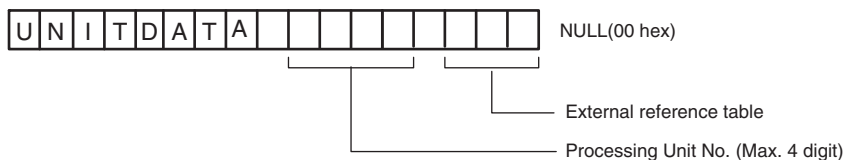

- Response (Sensor Controller to PLC)
Character string data equivalent to the Non-procedure command reception character string is returned.
NULL (00 hex) is inserted in the reception character string delimiter section.
The size of the reception data includes the final NULL(00 hex).

0123456789...UV(Character string data) NULL(00 hex) O(4F hex) K(4B hex) NULL(00 hex)

Output of Character String with Result Output (I/O) with EtherNet/IP

Use the **Result Output (I/O)** processing unit to output the read string.

For details, refer to *Communicating by EtherNet/IP - Setting Output Data (Numerical Values and Character Strings)* in the *Vision System FH/FHV Series User's Manual for Communications Settings (Cat. No. Z342)*.

Output of Character String with Result Output (I/O) with EtherCAT

Use the **Result Output (I/O)** processing unit to output the read string.

For details, refer to *EtherCAT Connections - Setting Output Data (Numerical Values and Character Strings)* in the *Vision System FH/FHV Series User's Manual for Communications Settings (Cat. No. Z342)*.

Output of Character String with Result Output (I/O) with PROFINET

Use the **Result Output (I/O)** processing unit to output the read string.

For details, refer to *Communicating by PROFINET - Setting Output Data (Numerical Values and Character Strings)* in the *Vision System FH/FHV Series User's Manual for Communications Settings (Cat. No. Z342)*.

2-26-6 Key Points for Test Measurement and Adjustment (Character Inspection)

The following content is displayed in the *Detail result* area as text.

Displayed item	Display color	Description
Judge	OK/Unmeasured: Black NG: Red	Judgment results 0: No judgment (unmeasured) 1: Judgment result OK -1: Judgment result NG -10: Error (image format mismatch) -11: Error (unregistered model) -12: Error (insufficient memory) -20: Error (other errors)
NG cause	0: Black Other than 0: Red	The following character strings are displayed. When there are multiple factors, the output is ORed. If both the correlation value and the character count are NG, "3" is output. 0: OK 1: Correlation values NG 2: Character count NG 4: Verification NG 8: Stability NG
Char. count	When the NG cause is the character count NG: Red Other NG: Black	The number of measured characters is displayed.
Read string	When the NG cause is verification NG: Red Other NG: Black	A character string read from the target unit is displayed.
Correlation	When the NG cause for each character is the correlation value NG: Red Other NG: Black	The correlation values for each character are displayed. Example) When 0123 is read Correlation values: 0 (99) 1 (56) 2 (80) 3(27)

Displayed item	Display color	Description
Stability	When the NG cause of each character is stability NG: Red Other NG: Black	Shows the stability of each character.

Key Points for Adjustment (Character Inspection)

Adjust the setting parameters referring to the following points.

● When the reading is unstable

Parameter to be adjusted	Remedy
Measurement parameter	If characters are close, specify larger values for <i>Horizontal succession</i> and <i>Vertical succession</i> .

● When the judgement is NG (insufficient memory).

Parameter to be adjusted	Remedy
Region setting	Make the search region as small as possible.

● When the processing speed is slow

Parameter to be adjusted	Remedy
Region setting	Make the search region as small as possible.

2-26-7 Measurement Results for Which Output Is Possible (Character Inspection)

The following values can be output using processing items related to result output. It is also possible to reference measurement values from calculation expressions and other processing units.

Measurement items	Character string	Description
Judge	JG	Judgment results 0: No judgment (unmeasured) 1: Judgment result OK -1: Judgment result NG -10: Error (image format mismatch) -11: Error (unregistered model) -12: Error (insufficient memory) -20: Error (other errors)
Char. count	NUM	Char. count
NG cause	NG	NG cause

For following items, additional expression data with 32 characters is allocated for each character. (* represents the character number.)

Unit No.*	CUNO*	Detected unit No. for the *th character
Index No.*	CINDEX*	Detected index number for the *th character
Model No.*	CMODEL*	Detected model number for the *th character

Measurement items	Character string	Description
Chara. code*	CCHAR*	Character code for the *th character For details, Refer to A-13 Character Code Table in Vision system FH/FHV Series User's Manual (Cat. No. Z365).
NG Cause *	CNG*	NG cause for the *th character

2-26-8 External Reference Tables (Character Inspection)

No.	Data name	Data ident	Set/Get	Data range
0	Judge	judge	Get only	0: No judgment (unmeasured), 1: Judgment result OK, -1: Judgment result NG, -10: Error (image format mismatch), -11: Error (unregistered model), -12: Error (insufficient memory), -20: Error (other errors)
1	Chara. Num	characterNum	Get only	0 to 32
2	NG Cause	nGCause	Get only	Detection NG cause of the entire read character string 0x0000 to 0x0015
3	Read string	readString	Get only	Character string
103	Reflect to overall judgement	overallJudge	Set/Get	0: ON, 1: OFF
120	Dictionary unit number 1	dicUnit0	Set/Get	-1: OFF 0 to 9,999: Unit No.
121	Dictionary unit number 2	dicUnit1	Set/Get	-1: OFF 0 to 9,999: Unit No.
122	Dictionary unit number 3	dicUnit2	Set/Get	-1: OFF 0 to 9,999: Unit No.
123	Dictionary unit number 4	dicUnit3	Set/Get	-1: OFF 0 to 9,999: Unit No.
124	Inspection mode	inspectMode	Set/Get	0: OCR, 1: OCR + Count, 2: OCV
125	Direction	direction	Set/Get	0: → 1: ↓ 2: ← 3: ↑
126	Character output	outputFlag	Set/Get	0: OFF, 1: ON
127	Character output destination	outputDevice	Set/Get	0: RS-232C/RS-422 *1 1: Ethernet
129	Horizontal succession	horizPermit	Set/Get	0 to 99
130	Vertical succession	vertPermit	Set/Get	0 to 99
132	Dictionary candidate point level usage flag	dicCandidate	Set/Get	0: Not used, 1: Used
133	Rough candidate	roughCandidate	Set/Get	0 to 100
134	Detail candidate	detailCandidate	Set/Get	0 to 100
135	Dictionary correlation usage flag	dicCorrelation	Set/Get	0: Not used, 1: Used
136	Lower limit of the corr.	lowerCorrlation	Set/Get	0 to 100

No.	Data name	Data ident	Set/Get	Data range
137	Upper limit of chara. Num	upperCharNum	Set/Get	1 to 32
138	Lower limit of chara. Num	lowerCharNum	Set/Get	1 to 32
139	Verification string	compareString	Set/Get	Character string
140+N (N=0 to 35)	Model 1 usage flag	FirstModelEnable00 to FirstModelEnable35	Set/Get	0: Not used, 1: Used
176+N (N=0 to 35)	Model 2 usage flag	SecondModelEnable00 to SecondModelEnable35	Set/Get	0: Not used, 1: Used
212+N (N=0 to 35)	Model 3 usage flag	ThirdModelEnable00 to ThirdModelEnable35	Set/Get	0: Not used, 1: Used
248+N (N=0 to 35)	Model 4 usage flag	FourthModelEnable00 to FourthModelEnable35	Set/Get	0: Not used, 1: Used
284	Scene No. 1	dicScene0	Set/Get	-1: Current scene 0 to 9,999: Scene No.
285	Scene No. 2	dicScene1	Set/Get	-1: Current scene 0 to 9,999: Scene No.
286	Scene No. 3	dicScene2	Set/Get	-1: Current scene 0 to 9,999: Scene No.
287	Scene No. 4	dicScene3	Set/Get	-1: Current scene 0 to 9,999: Scene No.
288	Lower limit of stability	lowerStability	Set/Get	0 to 100
1,000+N (N=0 to 31)	Unit No.	unitNo00 to unitNo31	Get only	-1: OFF 0 to 9,999: Unit No.
1,032+N (N=0 to 31)	Detected index	indexNo00 to indexNo31	Get only	0 to 35
1,064+N (N=0 to 31)	Detected model No.	modelNo00 to modelNo31	Get only	0 to 4
1,096+N (N=0 to 31)	Chara. code	charCode00 to charCode31	Get only	0 to 0xFFFF (UTF-16 code)
1,128+N (N=0 to 31)	Detected NG Cause	NGCause00 to NGCause31	Get only	Detection NG cause of each read character 0 to 15
1,160+N (N=0 to 31)	Correlation value	correlation00 to correlation31	Get only	0 to 100
1,192+N (N=0 to 31)	Detected coordinate X	positionX00 to positionX31	Get only	-99,999.9999 to 99,999.9999
1,224+N (N=0 to 31)	Detected coordinate Y	positionY00 to positionY31	Get only	-99,999.9999 to 99,999.9999
1,256+N (N=0 to 31)	Detected angle	angle00 to angle31	Get only	-180 to 180
1,288+N (N=0 to 31)	Reference X	standardX00 to standardX31	Get only	-99,999.9999 to 99,999.9999
1,320+N (N=0 to 31)	Reference Y	standardY00 to standardY31	Get only	-99,999.9999 to 99,999.9999

No.	Data name	Data ident	Set/Get	Data range
1,352+N (N=0 to 31)	Reference angle	standardAngle00 to standardAngle31	Get only	-180 to 180
1,384+N (N=0 to 31)	Detected Scene No.	sceneNo00 to scene- No31	Get only	-1: Current scene 0 to 9,999: Scene No.
1,416+N (N=0 to 31)	Second correlation value	secondCorrelation00 to secondCorrela- tion31	Get only	0 to 100
1,448+N (N=0 to 31)	Second index No.	secondIndexNo00 to secondIndexNo31	Get only	0 to 35
1,480+N (N=0 to 31)	Stability	stability00 to stabili- ty31	Get only	0 to 100
6,002	Format	cameraColor	Set/Get	1: Monochrome camera 2: Color camera
90,000	figure0 Count	figArea0_count	Set/Get	1
90,001	figure0 Type	figArea0_fig0_type	Set/Get	8: Rectangle
90,002	figure0 mode	figArea0_fig0_mode	Set/Get	0: OR
90,014	figure0 Rectangle Upper left position X	figAr- ea0_fig0_box_X0	Set/Get	-99,999 to 99,999
90,015	figure0 Rectangle Upper left position Y	figAr- ea0_fig0_box_Y0	Set/Get	-99,999 to 99,999
90,016	figure0 Rectangle Lower right position X	figAr- ea0_fig0_box_X1	Set/Get	-99,999 to 99,999
90,017	figure0 Rectangle Lower right position Y	figAr- ea0_fig0_box_Y1	Set/Get	-99,999 to 99,999
90,099	figure0 Update	figArea0_update	Set only	1: Update

*1. RS-422 is unavailable in the FH/FHV series.

2-27 Date Verification

This processing item creates a target string from the current date/time and compares it with read-in strings.

Used in the Following Case

When inspecting date of manufacture:

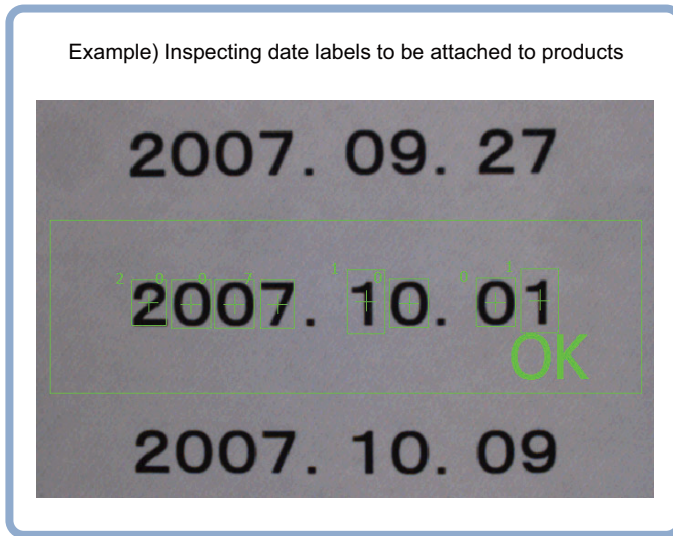

2-27-1 Settings Flow (Date Verification)

To set Date Verification, follow the steps below.

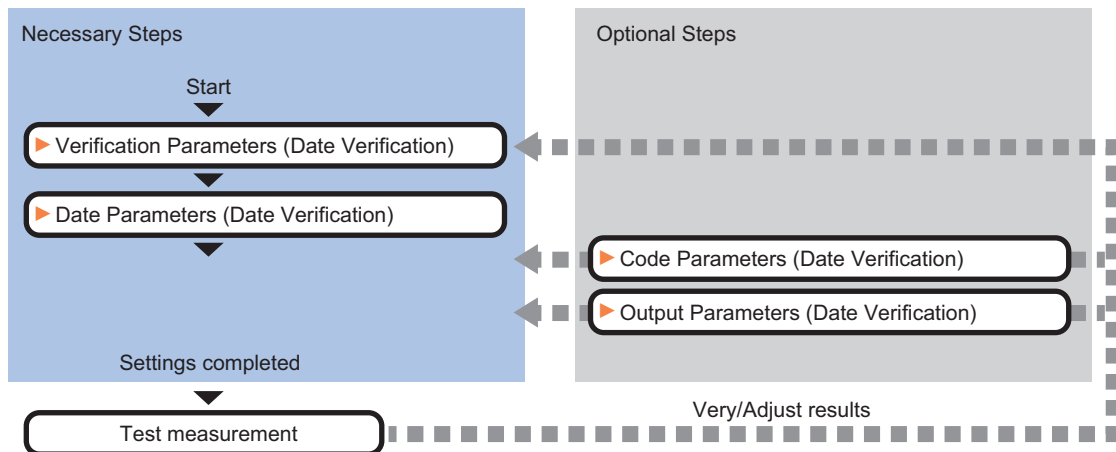

List of Date Verification Items

Item	Description
Verification	This item sets parameters of the verification string. 2-27-2 <i>Verification Parameters (Date Verification)</i> on page 2-409

Item	Description
Date parameter	This item sets the date/time format and update conditions. <i>2-27-3 Date Parameters (Date Verification) on page 2-410</i>
Code parameter	Set this to print the date encrypted in such a way that it is difficult for the user to recognize. Setting what codes show also makes possible automatic updating.
Output parameter	This item can be changed as necessary. Normally, the factory default value will be used. Use the output parameter to specify how to handle the coordinates. <i>2-27-5 Output parameter (Date Verification) on page 2-417</i>

2-27-2 Verification Parameters (Date Verification)

This item sets the verification target and the verification source character string.
The character string read in Character Inspection is the target for verification.

- 1 In the Item Tab area, click **Verification**.
- 2 This item sets the general OCR unit for verification.

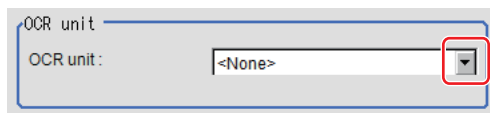

Additional Information

Always set Character Inspection in a unit before the Date Verification unit.

- 3 In the *Target string setting* area, click for *Target string expression*.
The String setting dialog is displayed.

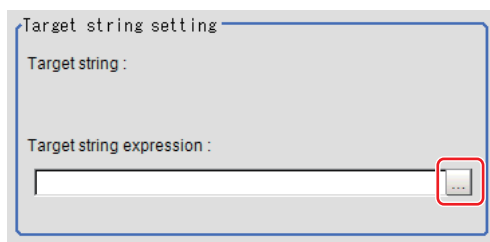

- 4 This item sets the character string that is the source for verification.
Input the date format and the preceding and following character strings.

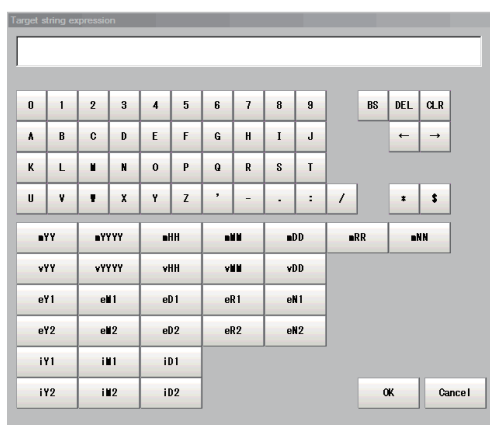

Label	Description
0 to 9	Normal numeric value input
A to Z	Normal alphabet input
' - . : / () +	Normal mark input
*	Character presence judgement
\$	Number judgement
mYY	The last two digits of the current year
mYYYY	Four digits of the current year
mHH	Two digits of the current year in the Japanese era calendar *1
mMM	Current month
mDD	Current day
mRR	Current hour
mNN	Current minute
vYY	The last two digits of the year of usage period set on the Date parameter tab
vYYYY	Four digits of the year of usage period set on the Date parameter tab
vHH	Two digits of the year of usage period set on the Date parameter tab in the Japanese era calendar *1
vMM	Month of usage period set on the Date parameter tab
vDD	Day of usage period set on the Date parameter tab
eY1	"Year 1" encrypted on the Code parameter tab
eM1	"Month 1" encrypted on the Code parameter tab
eD1	"Day 1" encrypted on the Code parameter tab
eR1	"Hour 1" encrypted on the Code parameter tab
eN1	"Minute 1" encrypted on the Code parameter tab
eY2	"Year 2" encrypted on the Code parameter tab
eM2	"Month 2" encrypted on the Code parameter tab
eD2	"Day 2" encrypted on the Code parameter tab
eR2	"Hour 2" encrypted on the Code parameter tab
eN2	"Minute 2" encrypted on the Code parameter tab
iY1	"Year 1" encrypted on the Code parameter tab for the usage period set on the Date parameter tab
iM1	"Month 1" encrypted on the Code parameter tab for the usage period set on the Date parameter tab
iD1	"Day 1" encrypted on the Code parameter tab for the usage period set on the Date parameter tab
iY2	"Year 2" encrypted on the Code parameter tab for the usage period set on the Date parameter tab
iM2	"Month 2" encrypted on the Code parameter tab for the usage period set on the Date parameter tab
iD2	"Day 2" encrypted on the Code parameter tab for the usage period set on the Date parameter tab

*1. The value referred to as an era name is determined by *the first year of era name* in the *Date setting* area.

5 Click **OK**.

2-27-3 Date Parameters (Date Verification)

This item sets the date/time format and update conditions.

- 1 In the Item Tab area, click **Date parameter**.
- 2 When comparing with character strings with an expiration date limit, set each item in the *Period setting* area.

Setting item	Setting value [Factory default]	Description
Year	0 to 99 [0]	This item sets the usage period from the current date. Refer to "How to calculate a usage period".
Month	0 to 99 [0]	
Day	-999 to 999 [0]	

- 3 In the *Date setting* area, specify a value for each item.

Setting item	Setting value [Factory default]	Description
Auto Update	<ul style="list-style-type: none"> • Not update • First measure • [Always update] 	Sets the year, month and day updating conditions. The clock time is always updated regardless of this setting. <ul style="list-style-type: none"> • Not update: The date is stored into memory when the processing unit is registered. The date is not updated until the next time date update is executed with the menu. • First measure: The date is updated during the first measurement after start up. • Always update: The date is updated every measurement.
Zero suppress	<ul style="list-style-type: none"> • [0] • Space 	Set how the tens digits of the month and day are displayed.
Calculation order	<ul style="list-style-type: none"> • [Month→Day] • Day→Month 	Set whether to calculate the month first or the day first when the usage period is set. The date for the usage period varies depending on the calculating order, for instance, in the case where a month that has 31 days or 30 days is spanned. Select this according to the calculating method of the usage period. Refer to "How to calculate a usage period".

Setting item	Setting value [Factory default]	Description
Month end adjust	<ul style="list-style-type: none"> • [Last day of current month] • First day of next month • Gap day of next month 	Set the adjustment method that will be used if the result of the expiration date calculation is an invalid date. Select this according to the calculating method of the usage period. Refer to "How to calculate a usage period".

4 Set the time margin.

Clicking **Date update** updates the date information of the verification string.

Setting item	Setting value [Factory default]	Description
Back margin	0 to 99 [0]	Sets a time range up to the current time to be judged OK. The unit is minutes. Example: When set to 10, a character string from 0 to 10 minutes before the Verification string time is judged OK.
Ahead margin	0 to 99 [0]	Sets a time range up to the current time to be judged OK. The unit is minutes. Example: When set to 10, a character string from 0 to 10 minutes before the Verification string time is judged OK.

● How to calculate a usage period

If a usage period is set and the date does not exist, such as 2/31, the calculated usage period date changes depending on the **Month end adjust** setting.

Use the following examples as reference for setting of the date parameter.

When the month end adjustment is not applied

Example 1:

- Measurement is performed on 2015/9/30, and the **Period setting** is: *Year: 0, Month: 1, Day: 1*.

The **Calculation order** is *Month→Day*.

A month is added to 9/30, and the result will be 10/30.

A day is added to 10/30, and the result will be 10/31.

Since 10/31 is a date existed, the month end adjustment will not be applied and the usage period will be 2015/10/31.

Example 2:

- Measurement is performed on 2015/9/30, and the **Period setting** is: *Year: 0, Month: 1, Day: 1*.

The **Calculation order** is *Day→Month*.

A day is added to 9/30, and the result will be 10/1.

A month is added to 10/1, and the result will be 11/1.

Since 11/1 is a date existed, the month end adjustment will not be applied and the usage period will be 2015/11/1.

When the month end adjustment is applied:

Example 1:

- Measurement is performed on 2015/1/31, and the **Period setting** is: *Year: 0, Month: 1, Day: 1*. The **Calculation order** is *Month→Day*.
A month is added to 1/31, and the result will be 2/31.
The month end adjustment will be applied since 2/31 does not exist.
The result of the month end adjustment plus 1 will be the verification string.

Month end adjust	Result	Calculated usage period
Last day of current month	Since the current month is February, the last day is 2015/2/28.	Add 1 day to 2/28, 2015/3/1
First day of next month	Since the current month is February, the start day of next month is 2015/3/1.	Add one day to 3/1, 2015/3/2
Gap day of next month	Since the current month is February, 2015/3/1 is the next month. There is a three-day gap between 2/28 existed and 2/31 calculated. Therefore, that day that one day shifts from existing 2/28 will be 3/3.	Add one day, 2015/3/4

Example 2:

- Measurement is performed on 2015/10/30, and the **Period setting** is: *Year: 0, Month: 1, Day: 1*. The **Calculation order** is *Day→Month*.
A day is added to 10/30, and the result will be 10/31.
A month is added to 10/31, and the result will be 11/31.
The month end adjustment will be applied since 11/31 does not exist.

Month end adjust	Result	Calculated usage period
Last day of current month	The current month is November, the last day of the month is 2015/11/30.	2015/11/30
First day of next month	The current month is November, the start day of next month will be 2015/12/1.	2015/12/1
Gap day of next month	The current month is November, 2015/12/1 will be in next month. There is a one-day gap between existing 11/30 and 11/31 calculated. Therefore, the day that one day shifts from existing 11/30 will be 12/1.	2015/12/1

2-27-4 Code Parameters (Date Verification)

Preset what the codes show so that date verification is possible even when printing the date encrypted in such a way that it is difficult for the user to recognize.

Based on the set encryption parameters, create a collation character string on the **Verification** tab and collate it with the read character string.

If the usage period is not set in the **Date parameter** tab, use the encrypted year / month / day / hour / minute (eY1, eM1, eD1, eR1, eN1, eY2, eM2, eD2, eR2, eN2) is set in the **Target string expression** on the **Verification** tab.

If the usage period is set on the **Date parameter** tab, use the year / month / day (iY1, iM1, iD1, iY2, iM2, iD2) after setting the encrypted period for the **Target string expression** on the **Verification** tab. The setting methods are to set on the screen or set with a PC.

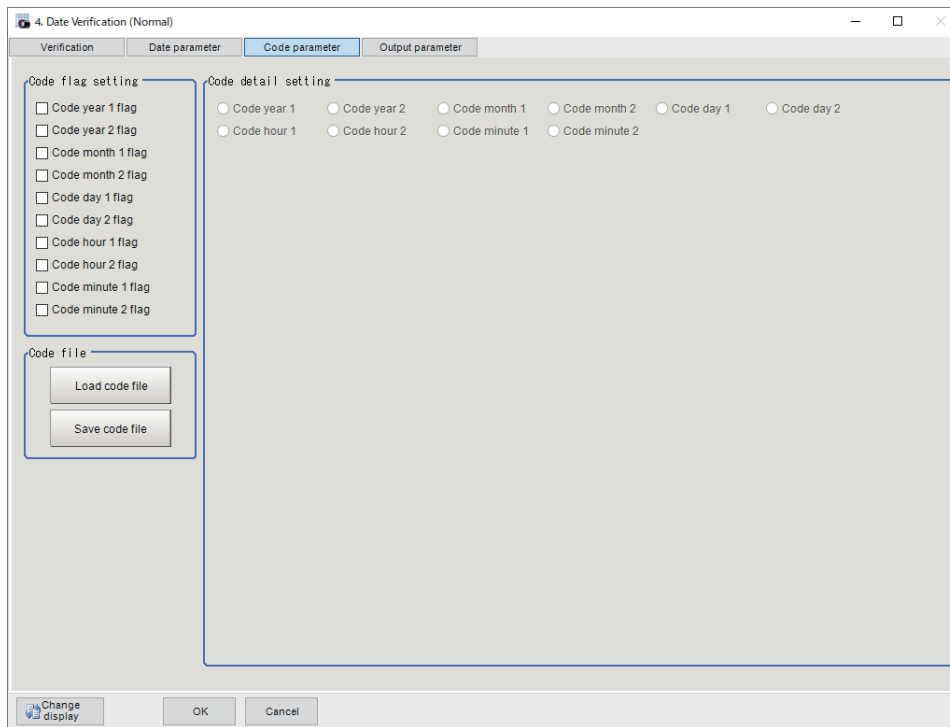

Setting on the Screen

This describes the setting method, using an example in which October is encrypted as X.

- 1** In the Item Tab area, click **Code parameter**.
- 2** In the *Code flag setting* area, place a check at **Code month 1 flag**.

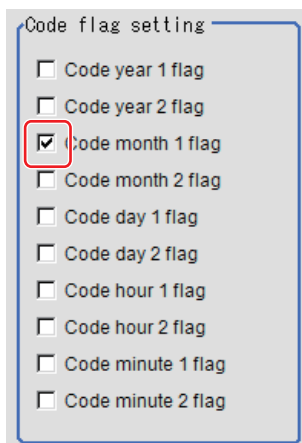

Additional Information

- Code month 1 and code month 2:
Set up code for 2 patterns in order to be ready for setup changes. Select a check at the one to use.

- 3** Place a check at **Code month 1** in the *Code detail setting* area.

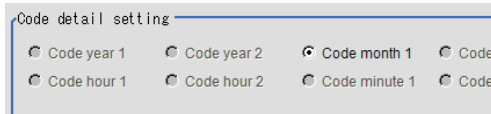

- 4** Click ... for 10.
The software keyboard is displayed. Input X.
Input a character string of up to 4 characters.

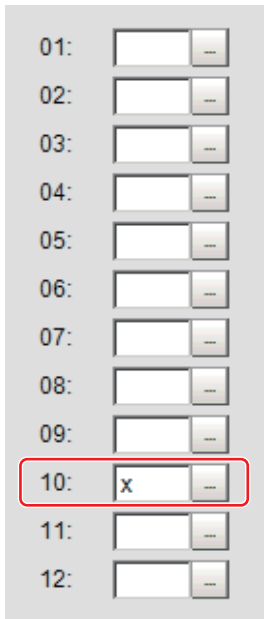

Setting with a PC

Code parameters are complex, so performing the settings with a PC makes file editing easier and minimizes mistakes.

Saving an empty CSV file first and then editing and reading it with a PC makes setting the values more efficient.

● Saving code files

Make an empty file for editing on the PC.

If encryption parameters are already set on the screen, a file reflecting those settings is saved.

- 1** In the Item Tab area, click **Code parameter**.
- 2** In the *Code flag setting* area, place a check at the flag used in the encrypted character strings to be edited.



- 3** In the *Code file* area, click **Save code file**.

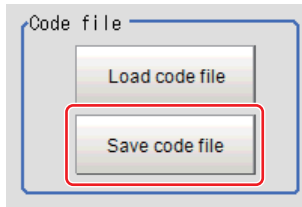

- 4** Set the save destination folder and file name, and click **OK**.
The code file is saved (in CSV format).

● Code file format

- The first line shows the *Code*.
- The second line shows the *Flag*. Input *1* when used.
- The third line and subsequent lines contain codes for each number.
Months and days start from *1*.

Code	Year1	Year2	Month1	Month2	Day1	Day2	Hour1	Hour2	Minute1	Minute2
Flag										
0										
1										
2										
3										
4										
5										
6										
7										
8										
9										
10										
11										
12										
13										
14										
15										
16										
17										
18										
19										
20										
21										
22										
23										
24										
25										
26										
27										
28										
29										
30										
31										
32										
.										
.										
.										
98										
99										

● Reading code files

- 1 In the Item Tab area, click **Code parameter**.
- 2 In the *Code file* area, click **Load code file**.

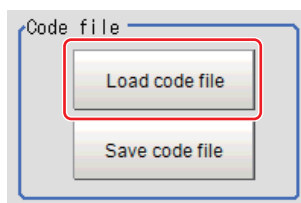

- 3 In the file selection window, select the code file (in CSV format) to read and click **OK**. The code file is read and the content is displayed in the window.

2-27-5 Output parameter (Date Verification)

Select whether or not to reflect the judgment results of this processing unit to the overall judgment of the scene.

- 1 In the Item tab area, click **Output parameter**.
- 2 Select whether or not to reflect it to the overall judgment in *Reflect to overall judgement* area.

Setting item	Setting value [Factory default]	Description
Reflect to overall judgment	<ul style="list-style-type: none"> • [ON] • OFF 	Enables choosing whether or not the judgement results of this processing unit is reflected in the scene overall judgment.

2-27-6 Key Points for Test Measurement and Adjustment (Date Verification)

The following content is displayed in the *Detail result* area as text.

Displayed item	Description
Judge	Judgment results 0: No judgment (unmeasured) 1: Judgment result OK -1: Judgment result NG -10: Error (image format mismatch) -11: Error (unregistered model) -12: Error (insufficient memory) -20: Error (other errors)
Target string	Displays the verification string
Read string	A character string read from the target unit is displayed.

2-27-7 Measurement Results for Which Output Is Possible (Date Verification)

The following values can be output using processing items related to result output. It is also possible to reference measurement values from calculation expressions and other processing units.

Measurement items	Character string	Description
Judge	JG	Judgment results 0: No judgment (unmeasured) 1: Judgment result OK -1: Judgment result NG -10: Error (image format mismatch) -11: Error (unregistered model) -12: Error (insufficient memory) -20: Error (other errors)

2-27-8 External Reference Tables (Date Verification)

No.	Data name	Data ident	Set/Get	Data range
0	Judge	judge	Get only	0: No judgment (unmeasured), 1: Judgment result OK, -1: Judgment result NG, -10: Error (image format mismatch), -11: Error (unregistered model), -12: Error (insufficient memory), -20: Error (other errors)
1	Target string	targetString	Get only	Character string

No.	Data name	Data ident	Set/Get	Data range
2	Read string	readString	Get only	Character string
103	Reflect to overall judgement	overallJudge	Set/Get	0: ON, 1: OFF
120	OCR unit number	ocrUnit	Set/Get	-1: Null 0 to 9,999: Unit No.
124	Target string expression	stringExpress	Set/Get	Character string
125	Term year	termYear	Set/Get	0 to 99
126	Term month	termMonth	Set/Get	0 to 99
127	Term day	termDay	Set/Get	-999 to 999
128	Auto Update	autoUpdate	Set/Get	0: Not update, 1: First measurement after startup, 2: Always update
129	Zero suppress	zeroSuppress	Set/Get	0: 0, 1: Space
130	Calculation order	orderMonthDay	Set/Get	0: Month → Day, 1: Day → Month
131	Month end adjust	adjustMonthEnd	Set/Get	0: Last day of now, 1: First day of next, 2: Gap day of next
132	Back margin	forwardMargin	Set/Get	0 to 99
133	Ahead margin	backMargin	Set/Get	0 to 99
134	Code year 1 flag	flagYear1	Set/Get	0: Not used, 1: Used
135	Code year 2 flag	flagYear2	Set/Get	0: Not used, 1: Used
136	Code month 1 flag	flagMonth1	Set/Get	0: Not used, 1: Used
137	Code month 2 flag	flagMonth2	Set/Get	0: Not used, 1: Used
138	Code day 1 flag	flagDay1	Set/Get	0: Not used, 1: Used
139	Code day 2 flag	flagDay2	Set/Get	0: Not used, 1: Used
140	Code hour 1 flag	flagHour1	Set/Get	0: Not used, 1: Used
141	Code hour 2 flag	flagHour2	Set/Get	0: Not used, 1: Used
142	Code minute 1 flag	flagMinute1	Set/Get	0: Not used, 1: Used
143	Code minute 2 flag	flagMinute2	Set/Get	0: Not used, 1: Used
150	String year 1 flag	stringYear1	Set/Get	Character string
151	String year 2 flag	stringYear2	Set/Get	Character string
152	String month 1 flag	stringMonth1	Set/Get	Character string
153	String month 2 flag	stringMonth2	Set/Get	Character string
154	String day 1 flag	stringDay1	Set/Get	Character string
155	String day 2 flag	stringDay2	Set/Get	Character string
156	String hour 1 flag	stringHour1	Set/Get	Character string
157	String hour 2 flag	stringHour2	Set/Get	Character string
158	String minute 1 flag	stringMinute1	Set/Get	Character string
159	String minute 2 flag	stringMinute2	Set/Get	Character string
160	Operation code number	operateStringNo	Set/Get	0 to 99
180	A.D. Year of Era Year 1	firstYearJpnEra	Set/Get	0 to 9,999
1,000+N (N=0 to 99)	String year 1 data	stringYear100 to stringYear199	Set/Get	Character string
1,100+N (N=0 to 99)	String year 2 data	stringYear200 to stringYear299	Set/Get	Character string

No.	Data name	Data ident	Set/Get	Data range
1,200	String month 1 data1	stringMonth100	Set/Get	Character string
:	:	:	:	:
1,211	String month 1 data12	stringMonth111	Set/Get	Character string
1,300	String month 2 data1	stringMonth200	Set/Get	Character string
:	:	:	:	:
1,311	String month 2 data12	stringMonth211	Set/Get	Character string
1,400	String day 1 data1	stringDay100	Set/Get	Character string
:	:	:	:	:
1,430	String day 1 data31	stringDay130	Set/Get	Character string
1,500	String day 2 data1	stringDay200	Set/Get	Character string
:	:	:	:	:
1,530	String day 2 data31	stringDay230	Set/Get	Character string
1,600+N (N=0 to 23)	String hour 1 data	stringHour100 to stringHour123	Set/Get	Character string
1,700+N (N=0 to 23)	String hour 2 data	stringHour200 to stringHour223	Set/Get	Character string
1,800+N (N=0 to 59)	String minute 1 data	stringMinute100 to stringMinute159	Set/Get	Character string
1,900+N (N=0 to 59)	String minute 2 data	stringMinute200 to stringMinute259	Set/Get	Character string

2-28 Model Dictionary

Register a model to use for *Character Inspection*. Model data registered in the *Model Dictionary* can be referred to from multiple *Character Inspection* items in the same scene.

Used in the Following Case

To create the dictionary to be used for Character Inspection and Date Verification:

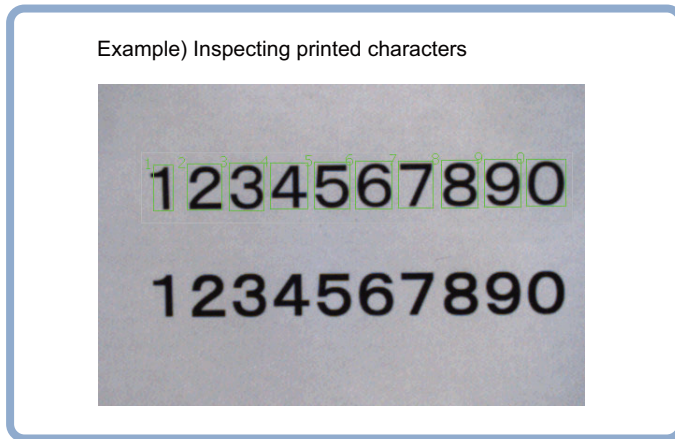

Precautions for Correct Use

Processing is different for color images and monochrome images. When the camera type used in the previous setup was changed to color or monochrome type, perform the settings again.

2-28-1 Settings Flow (Model Dictionary)

To set Model Dictionary, follow the steps below.

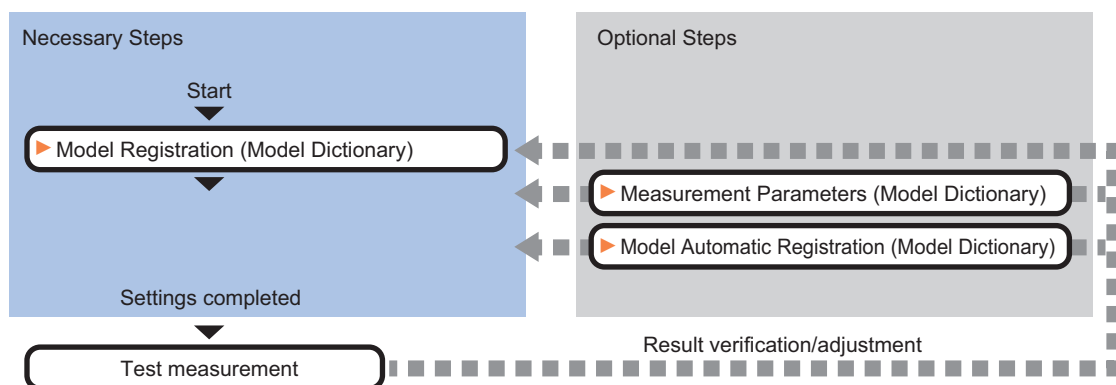

List of Model Dictionary Items

Item	Description
Model	Register characters and marks as a model. Model parameter values can be changed as needed to address unstable measurement results or to increase the processing speed. Normally, the factory default value will be used. <i>2-28-2 Model Registration (Model Dictionary) on page 2-422</i>
Measurement parameter	This item is changed as necessary. <i>2-28-3 Measurement Parameters (Model Dictionary) on page 2-425</i>
Auto registration	When registering multiple characters as models, auto registration is handy. This method encloses a character string, cuts out one character at a time from it and registers them as models. <i>2-28-4 Model Automatic Registration (Model Dictionary) on page 2-425</i>

2-28-2 Model Registration (Model Dictionary)

Register the characters and marks as the model.

Models can be registered with any of 36 indexes, from 0 to 35, and up to 5 models can be registered for each index.

Select the character type

By factory default, 0 to 9 and A to Z are assigned to indexes 0 to 35. These assignments can be changed as necessary with the % and # codes.

0	C	O
1	D	P
2	E	Q
3	F	R
4	G	S
5	H	T
6	I	U
7	J	V
8	K	W
9	L	X
A	M	Y
B	N	Z

Index 0 to 11 Index 12 to 23 Index 24 to 35

- 1** In the Item Tab area, click **Model**.
When setting a new model, you do not have to click **Model**.
- 2** Set the character type.

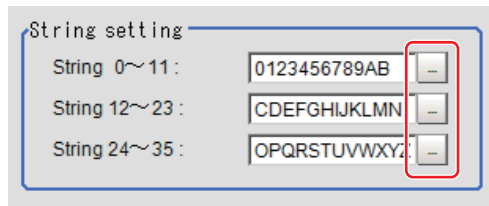

Registering a Model

This method is for registering models one character at a time.



Additional Information

When registering multiple characters as models, auto registration is handy.
Refer to *2-28-4 Model Automatic Registration (Model Dictionary)* on page 2-425.

- 1** In the Item Tab area, click **Model**.
- 2** When the measurement object is rotating, set the Angle range for the *Model parameter* area.
Refer to *Changing Model Parameters* on page 2-424.
- 3** Select the index to register the model in, then click **New**.

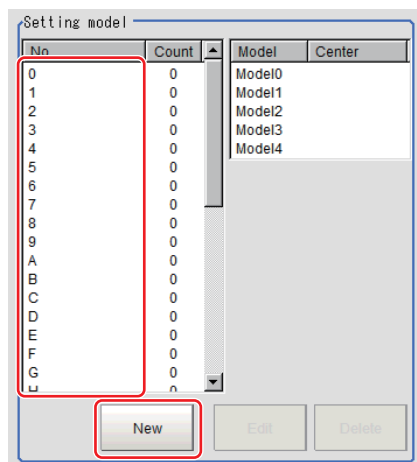

- 4** Use the Drawing tools to specify the model registration range.

- 5** Click **OK**.

The model is registered and its central X and Y coordinate values are displayed in the *Setting model* area.

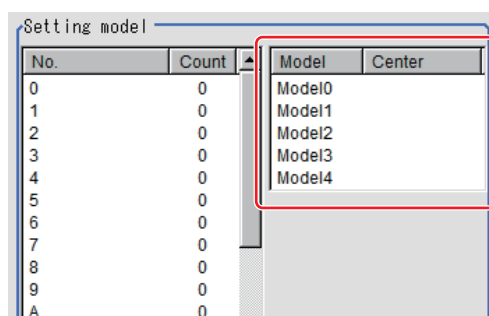

The image specified for the model is displayed in the *Image Display* area.

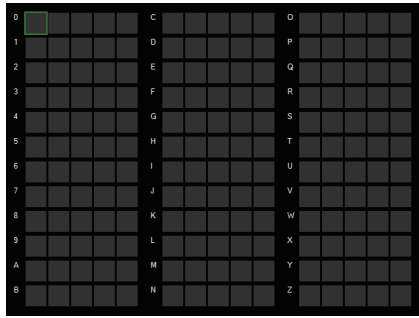

- 6** To register two or more models, repeat the Steps 3 to 5.

Changing Model Parameters

Model parameter values can be changed as needed to address unstable measurement results or to increase the processing speed. Normally, the factory default value will be used.

After changing a setting, check whether measurement can be done properly by performing an actual measurement.



Precautions for Correct Use

After model parameters are modified, re-register all models.

- 1** In the *Model parameter* area, specify a value for each item.

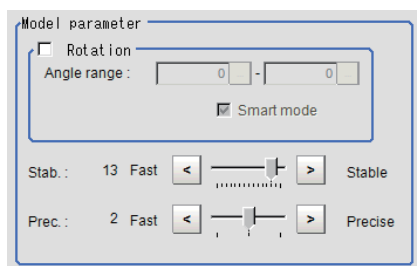

Setting item	Setting value [Factory default]	Description
Rotation	<ul style="list-style-type: none"> Checked [Unchecked] 	When the measurement object rotates, place a check at <i>Rotation</i> and set the Angle range during a search. The normal direction is clockwise.
Angle range	-45 to 45 [0]	
Smart mode	<ul style="list-style-type: none"> [Checked] Unchecked 	Checking the <i>Smart mode</i> option enables a high-speed rotation search. However, the stability may be lowered when the model shape aspect ratio is large or when the NOT mask is used.
Stab.	1 to 15 [13]	Specify which is to have priority, measurement stability or speed. If lowering stability does not speed up processing, it is likely that many candidates have been detected. In this case, specify a larger value for <i>Candidate LV</i> or <i>Stab.</i>
Prec.	1 to 3 [2]	Specify which is to have priority, measurement positional precision or speed.

2-28-3 Measurement Parameters (Model Dictionary)

This item can be changed if necessary. Normally, the factory default value will be used.

- 1 In the Item Tab area, click **Measurement**.
- 2 In the *Measurement condition* area, specify a value for each item.

Setting item	Setting value [Factory default]	Description
Batch setting	<ul style="list-style-type: none"> • [Checked] • Unchecked 	Specifies whether to set all Measurement values at the same time. <ul style="list-style-type: none"> • Checked: The same contents are set for all indexes. • Unchecked: The contents are only set for the selected index.
Correlation	0 to 100 [60]	Specifies the lower limit of correlation values that are judged to be OK. This is the threshold for whether or not the candidate can be read in as a character.
Rough candidate	0 to 100 [40]	Specify the threshold value with which to detect candidate points in a rough search. Specify a smaller value when model search results are unreliable.
Detail candidate	0 to 100 [60]	Specifies the threshold value with which to detect candidate points in a detail search. Only the candidate points higher than this level are extracted as characters.

2-28-4 Model Automatic Registration (Model Dictionary)

This method encloses a character string, cuts out one character at a time from it and registers them as models. When an auto extraction region is set enclosing the character string, the characters are automatically extracted one at a time. Register each character in the appropriate character index. If 5 models have already been registered for an index, auto registration cannot be set.

- 1 In the Item Tab area, click **Auto registration**.
- 2 In the *Detail* area, select *Auto extract region*.



- 3 Click **Edit**.

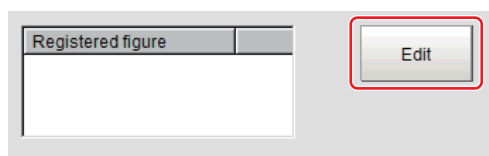

- 4 Specify the range to register as the auto extract region using the Drawing tools.
- 5 Click **OK** in the *Figure setting* area.
 - **OK**: Changes the settings and returns to the previous menu.
 - **Cancel**: Changes are discarded. Returns to the previous menu.

- **Apply:** Updates the settings without leaving edit window.

6 Click **Extract model**.

A model is extracted automatically and the extracted result (gray frame) is displayed in the *Image Display* area.

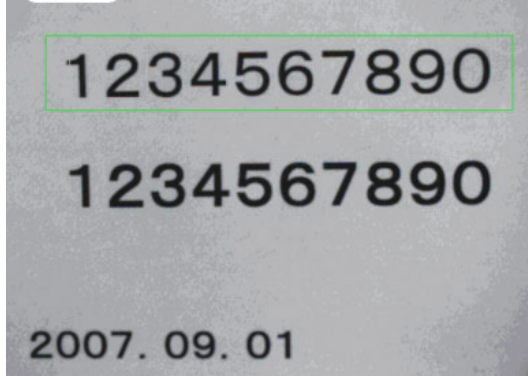

7 In the *Detail* area, select *Auto model region*.



8 To adjust an extracted region, click **Edit**.

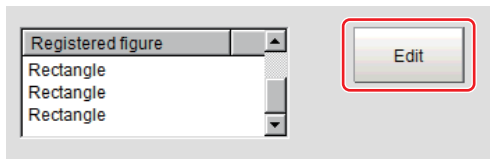

9 Click the model region in the *Image Display* area.

An index list is displayed.

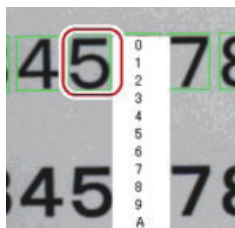

10 Select the index to register to.

11 Click **Register model**.

A message which indicates the number of registered models is displayed.

12 Click **OK**.

The model is registered.

13 With the same operation, register the models for the other extraction regions.

2-28-5 Key Points for Test Measurement and Adjustment (Model Dictionary)

The following content is displayed in the *Detail result* area as text.

Displayed item	Description
Judge	Judgment results 0: No judgment (unmeasured) 1: Judgment result OK -1: Judgment result NG -10: Error (image format mismatch) -11: Error (unregistered model) -12: Error (insufficient memory) -20: Error (other errors)

Key Points for Adjustment (Model Dictionary)

Adjust the setting parameters referring to the following points.

● When the measurement results are unstable

Parameter to be adjusted	Remedy
Model parameter	If the model image consists of detailed figures, specify a larger value for <i>Stab</i> . When <i>Rotation</i> is selected, if the model shape is complex, uncheck the <i>Smart mode</i> option.
Measurement parameter	If images that should be judged OK vary greatly, specify a smaller value for <i>Candidate LV</i> .

● When the processing speed is slow

Parameter to be adjusted	Remedy
Model parameter	If the model image is a simple figure or a large figure, specify a smaller value for <i>Stab</i> . If lowering stability does not speed up processing, it is likely that many candidates have been detected. Raise the <i>Candidate LV</i> in <i>Measurement</i> .
	When <i>Rotation</i> is selected and the model image is a simple figure, place a check at the <i>Smart mode</i> .
Measurement parameter	If images that should be judged OK vary little, specify a larger value for <i>Candidate LV</i> .

2-28-6 Measurement Results for Which Output Is Possible (Model Dictionary)

The following values can be output using processing items related to result output. It is also possible to reference measurement values from calculation expressions and other processing units.

Measurement items	Character string	Description
Judge	JG	Judgment results 0: No judgment (unmeasured) 1: Judgment result OK -1: Judgment result NG -10: Error (image format mismatch) -11: Error (unregistered model) -12: Error (insufficient memory) -20: Error (other errors)

2-28-7 External Reference Tables (Model Dictionary)

No.	Data name	Data ident	Set/Get	Data range
0	Judge	judge	Get only	0: No judgment (unmeasured), 1: Judgment result OK, -1: Judgment result NG, -10: Error (image format mismatch), -11: Error (unregistered model), -12: Error (insufficient memory), -20: Error (other errors)
121	With rotation	rotation	Set/Get	0: OFF, 1: ON
122	Upper limit of the rotation angle	endAngle	Set/Get	-45 to 45
123	Lower limit of the rotation angle	startAngle	Set/Get	-45 to 45
125	Smart mode	smartMode	Set/Get	0: OFF, 1: ON
126	Stab.	stability	Set/Get	1 to 15
127	Prec.	accuracy	Set/Get	1 to 3
140	Character string	string	Set/Get	0 to 35
200+N (N=0 to 35)	Lower limit of the corr.	lowerCorrelation00 to lowerCorrelation35	Set/Get	0 to 100
300+N (N=0 to 35)	Candidate point level (approximate search)	roughCandidate00 to roughCandidate35	Set/Get	0 to 100
400+N (N=0 to 35)	Candidate point level (detail)	detailCandidate00 to detailCandidate35	Set/Get	0 to 100
6,002	Format	cameraColor	Set/Get	1: Monochrome camera 2: Color camera

2-29 2D Code

Read in 2D Code.

The read-in results can be utilized to classify target objects.

With 2D Code, detailed communication and reading result can be output.

Used in the Following Case

To classify with 2D Code

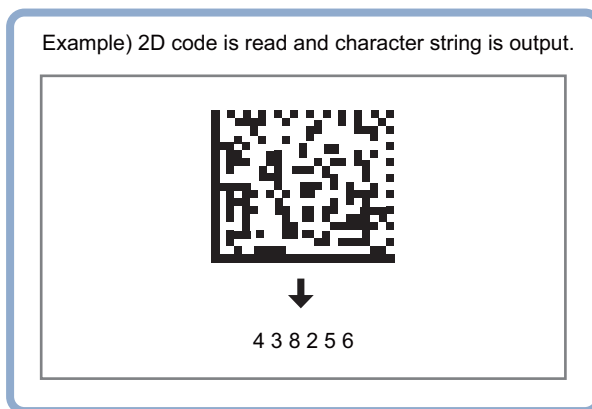

Precautions for Correct Use

- 2D Code including Japanese is not supported. Only 2D Code configured with ASC II code is supported.
- Processing is different for color images and monochrome images. When the camera type used in the previous setup was changed to color or monochrome type, perform the settings again.
- The number of pixels of the measurement region that can be read varies depending on the Read Mode selection.
 - Normal: 1,920,000 pixels or less
 - DPM: 5,003,712 pixels or less

2-29-1 Settings Flow (2D Code)

To set 2D Code, follow the steps below.

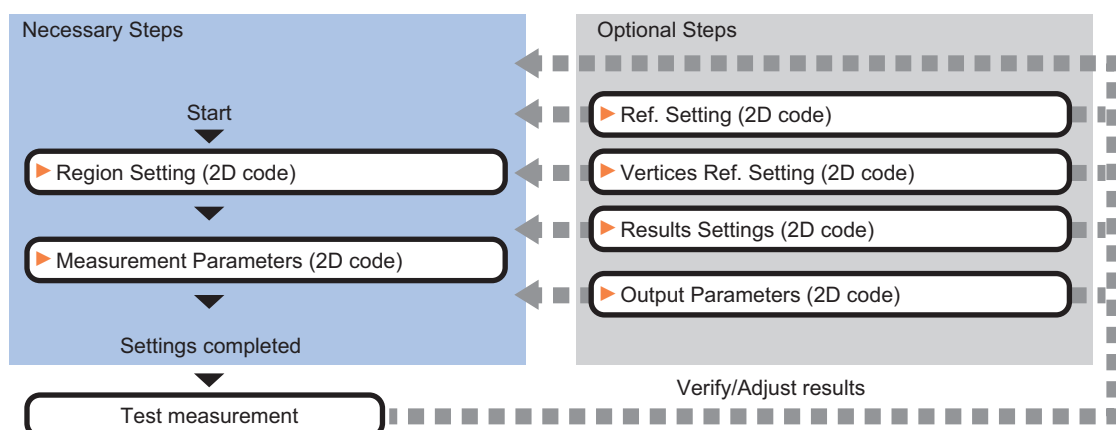

List of 2D Code Items

Item	Description
Region setting	Sets the measurement area. It is possible to target the entire screen, but restricting the range can shorten the processing time. <i>2-29-2 Region Setting (2D Code) on page 2-430</i>
Measurement parameter	Sets processing conditions for measurement and judgment conditions for measurement results. Sets a code type, and the number of characters to judge as OK. <i>2-29-3 Measurement Parameters (2D Code) on page 2-430</i>
Ref. setting	Sets the code center coordinates and code angle. <i>2-29-4 Reference Settings (2D Code) on page 2-435</i>
Vertices Ref. Setting	Sets the coordinates for each vertex of the code. <i>2-29-5 Vertices Reference Setting (2D Code) on page 2-437</i>
Result setting	Sets the measurement results. Judgment results can be classified. <i>2-29-6 Results Settings (2D Code) on page 2-439</i>
Output parameter	This item can be changed as necessary. Normally, the factory default value will be used. <i>2-29-7 Output Parameters (2D Code) on page 2-439</i>

2-29-2 Region Setting (2D Code)

Specify the area to search 2D Code with a rectangular.
Reducing the measurement range shortens the processing time.



Precautions for Correct Use

- Normal (DataMatrix/QRCode/MicroQR/PDF417/MicroPDF417):
Set the measurement region to 1600 × 1200 or less.
- DPM mode (DataMatrix/QRCode):
Set the measurement region to 2448 × 2044 or less.
- Set the measurement region so that only one 2D Code is included.
If there are more than one 2D Code in the measurement region, measurement may not be performed properly.

- 1** In the Item tab area, click **Region setting**.
- 2** Click **Edit**.
The *Figure Setting* area is displayed.
- 3** Specify the area to search 2D Code.
The rectangle covering the entire screen is set. Adjust the size and position of the rectangle.
- 4** Click **OK** in the *Figure setting* area.
 - **OK**: Changes the settings and returns to the previous menu.
 - **Cancel**: Changes are discarded. Returns to the previous menu.
 - **Apply**: Updates the settings without leaving edit window.

2-29-3 Measurement Parameters (2D Code)

This item specifies the judgement conditions for measurement conditions and measurement results.

When the **Teaching** button is clicked, detailed settings are set automatically.

If you then click the **Measurement** button, measurement is executed, the detected 2D Code region is displayed on the image and the measurement results are displayed as measurement value of the judgement condition.

If measurement cannot be carried out successfully with this procedure, adjust the parameters shown below.

- 1 In the Item Tab area, click **Measurement**.
- 2 Select the read mode.



Setting item	Setting value [Factory default]	Description
Read mode	<ul style="list-style-type: none"> • [Normal] • DPM 	Usually, set this to <i>Normal</i> . Select <i>DPM</i> to read 2D Code to which direct parts marking (DPM) was applied.

- 3 To teach, click **Teaching**.
The detailed settings are set automatically.

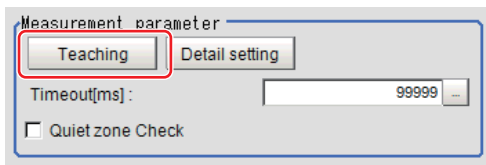

Setting item	Setting value [Factory default]	Description
Timeout	50 to 99,999 [99,999]	Stop and terminate the process if measurement for this processing item cannot be completed within the specified time period. Note that the actual timeout time may be longer than the specified time period.
Quiet zone Check (only when the read mode is Normal.)	<ul style="list-style-type: none"> • Checked • [Unchecked] 	Check whether or not there is any space around a 2D Code. (When a <i>code type</i> is PDF417 or MicroPDF417, this item cannot be selected.)

- 4 When making the detailed settings, click **Detail setting** and set each item.

Setting item	Setting value [Factory default]	Description
Common		
Code type	<ul style="list-style-type: none"> [DataMatrix] QRCode MicroQR PDF417 MicroPDF 	<p>Specifies the code type</p> <p>The readable size for each code type are as follows.</p> <ul style="list-style-type: none"> Symbol size <ul style="list-style-type: none"> DataMatrix: 64 × 64 cells or less QRCode: 57 × 57 cells or less Size of 1 cell <ul style="list-style-type: none"> Normal (DataMatrix/QRCode/MicroQR): 4 × 4 pixels or more DPM (DataMatrix/QRCode): 4 × 4 pixels or more Module size <ul style="list-style-type: none"> Normal (PDF417/MicroPDF417): the aspect ratio is 3 vs. 1 or more and the horizontal length is 3 pixels or more.
Code color	<ul style="list-style-type: none"> [Auto] Black White 	<p>Selects the color of the 2D Code to read.</p> <ul style="list-style-type: none"> Auto: Select this for automatic discrimination. Black: Select this for black 2D Code with a white background. White: Select this for white 2D Code with a black background.
Code length: Auto	<ul style="list-style-type: none"> [Checked] Unchecked 	<p>Places a check here when applying automatic discrimination for code length.</p>
Code length	50 to 2,448 [50]	<p>Specify the code length in the long side in the unit of pixel. The margin (Quiet zone) is not included.</p> <p>A code that the code length is less than +/- 50% of the setting value is detected.</p> <p>By setting the value to close to the actual code length, the unnecessary code candidates become hard to be detected so that the improvement of the reading performance can be expected.</p> <p>No code can be detected when the code length fluctuates +/- 50% or more. In that case, use <i>Auto</i> option.</p>

Setting item	Setting value [Factory default]	Description
Mirror setting	<ul style="list-style-type: none"> • [Auto] • Normal • Reverse 	Selects whether or not to reverse the image horizontally.
Magnify level: Auto	<ul style="list-style-type: none"> • [Checked] • Unchecked 	The inspection is done with an image reduced. Using such reduced image shortens the processing time. Selects whether or not to automatically set the reduction ratio of images when reading code.
Magnify level	0 to 4 [0]	Specifies the reduction ratio for images when reading code. 0: Read an image by generating the images with the magnify level 1 to 4. 1: 1 2: 1/4 3: 1/16 4: 1/64
DataMatrix		Specifies when <i>DataMatrix</i> is selected for <i>Code type</i> .
Shape	<ul style="list-style-type: none"> • [Auto] • Square • Rectangle 	Selects the shape of DataMatrix.
Code size	For <i>Square</i> : <ul style="list-style-type: none"> • [Auto] • 10×10 • 12×12 • : • 64×64 For <i>Rectangle</i> : <ul style="list-style-type: none"> • [Auto] • 8×18 • 8×32 • : • 16×48 	Selects the size of DataMatrix.
QR code		Specifies when <i>QRCode</i> is selected for <i>Code type</i> .
Size	<ul style="list-style-type: none"> • [Auto] • 21×21 • 25×25 • : • 57×57 	Selects the size of QR code.
Model	<ul style="list-style-type: none"> • [Auto] • Model 1 • Model 2 	Selects the model of QR code.
ECC level	<ul style="list-style-type: none"> • [Auto] • M • L • H • Q 	Specifies the ECC leve (error correction level) for QR code.
MicroQR		Specifies when <i>MicroQR</i> is selected for <i>Code type</i> .

Setting item	Setting value [Factory default]	Description
Size	<ul style="list-style-type: none"> • [Auto] • 11×11 • 13×13 • 15×15 • 17×17 	Selects the size of MicroQR.
ECC level	<ul style="list-style-type: none"> • [Auto] • L • M • Q 	Specifies the ECC level (error correction level) for MicroQR.

5 Make the display settings for read-in character strings.

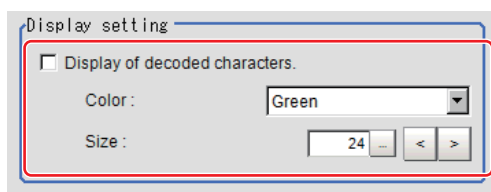

Setting item	Setting value [Factory default]	Description
Display of decoded characters	<ul style="list-style-type: none"> • Checked • [Unchecked] 	Places a check here when displaying the decoded characters.
Color	<ul style="list-style-type: none"> • Black • White • Red • [Green] • Blue 	Specifies the color for displayed characters.
Size	10 to 200 [24]	Specifies the size of displayed characters.

6 To read codes containing group separators, set a group separator replacement condition.

Setting item	Setting value [Factory default]	Description
Replace the GS (Group Separator) with a specified character string	<ul style="list-style-type: none"> • Checked • [Unchecked] 	Places a check here to replace each GS (Group Separator) with a specified character string when <i>Normal</i> is selected for the <i>Read mode</i> .
Replacement character string	-	Sets the character string to replace GS with.



Additional Information

Replacing each group separator (control character) with arbitrary character string enables codes containing group separators to be read and compared to a comparison character string.

7 When the setting has been changed, click **Measure** in the *Detail* area to verify whether measurements can be made correctly.

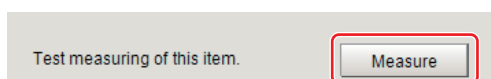

8 Set up the judgement condition.

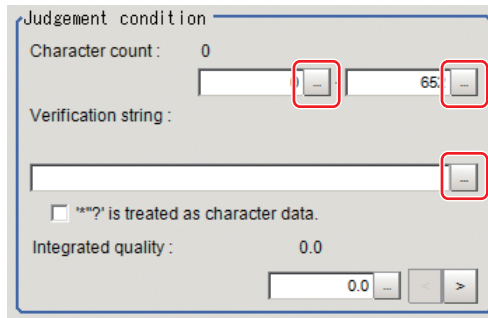

Setting item	Setting value	Description
Character count	0 to 652	Specifies the character count to be judged as OK.
Verification string	-	Specifies the comparison string to be judged as OK Up to 652 characters can be specified.
* and ? are used as character data	<ul style="list-style-type: none"> • Checked • [Unchecked] 	Checked: * and ? are treated as normal characters. Unchecked: * and ? are treated as special characters. *: Substitution for character string (with zero or more characters).
Integrated quality (lower limit value) (only when the read mode is Normal)	0.0 to 4.0 [0.0]	Specifies the integrated quality to be judged as OK. This item is available only when the <i>code type</i> is DataMatrix, PDF417, or MicroPDF417.

2-29-4 Reference Settings (2D Code)

Set a center position and the angle for a 2D Code.

There are two setting methods: specifying directly or referencing a unit.

Specifying Directly

Click a position on the image you want to use as a reference position, or input coordinate data for that point.

- 1 In the Item tab area, click **Ref. setting**.
In the *Display* area, the current reference position will be displayed as the crosshair cursor.

- 2 In the *Method* area, select *Numerical*.

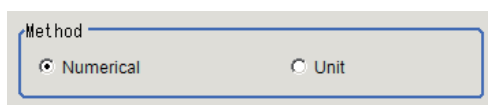

- 3 Click the position to be set as the reference.



Additional Information

Displaying the image enlarged makes this clicking easier.

For details, refer to *Appendix Basic Knowledge about Operations Using the Zoom Function* in the *Vision System FH/FHV Series User's Manual* (Cat. No. Z365).

- 4 Make fine adjustments using numeric value inputs or the arrow buttons as required.

Reference coordinate

Position :

320.0000 , 240.0000

Angle : 0.0000

- 5 Set the reference angle with a numeric value.

- 6 To remeasure on the displayed image and set the reference, click **Measure ref.**.
To update the reference angle at the time of reference measurement, place a check at *Update the angle when measure ref.* .

Update the angle when measure ref.

- 7 To use data before position compensation for the reference setting coordinates, place a check at *Use point coordinate before scroll.*

Use point coordinate before scroll

Position X : 320.0000

Position Y : 240.0000

Angle : 0.0000



Precautions for Correct Use

If you check *Use point coordinate before scroll*, do not use the following processing items. Otherwise, correct search results cannot be obtained.

- Precise Calibration
- Calibration Data Reference

Referencing a Unit

Set a reference by referencing a detection point unit with registered X coordinate, Y coordinate and angle data.

- 1 In the Item tab area, click **Ref. setting**.
In the *Display* area, the current reference position will be displayed as the crosshair cursor.

- 2** In the *Method* area, select *Unit*.

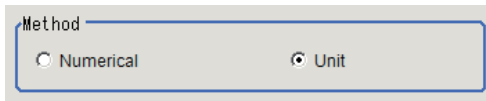

- 3** In the *Unit* area, select a detection point unit in the scene.

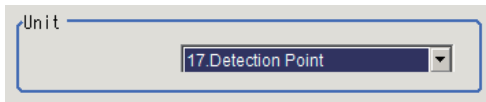

Performing the next measurement will display the reference.

2-29-5 Vertices Reference Setting (2D Code)

Set coordinates for each vertex of a 2D Code. The coordinates for each vertex do not correspond to camera coordinates and are determined by a shape of the 2D Code. There are two setting method: specifying directly and referencing a unit.

Specifying Directly

Click each vertex position on the image or input the coordinate data for it.

- 1** In the Item tab area, click **Vertices Ref. setting**.
- 2** In the *Display* area, the current each vertex position will be displayed with a box.
- 3** In the *Method* area, select **Numerical**.

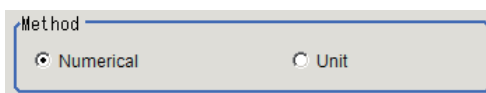

- 4** Drag and drop the box on the each vertex position.



Additional Information

Displaying the image enlarged makes this clicking easier. For details, refer to *Appendixes Basic Knowledge about Operations Using the Zoom Function* in the *Vision System FH/FHV Series User's Manual* (Cat. No. Z365).

- 5** Adjust finely by inputting numerical value or using the arrows as necessary.

Position	Set coordinates
Upper left Reference	100.0000,100.0000
Lower left Reference	100.0000,300.0000
Lower right Reference	300.0000,300.0000
Upper right Reference	300.0000,100.0000

Position : Upper left Reference

Reference X :

Reference Y :

- 6** When to set the coordinates for each vertex by remeasuring the currently displayed image, click **Measure ref.**

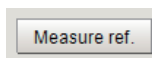

- 7** When to use them before position compensation as the coordinates for each vertex, place a check to *Use the point coordinate before scroll.*

Use point coordinate before scroll

Upper left Reference X : 100.0000

Upper left Reference Y : 100.0000

Lower left Reference X : 100.0000

Lower left Reference Y : 300.0000

Lower right Reference X : 300.0000

Lower right Reference Y : 300.0000

Upper right Reference X : 300.0000

Upper right Reference Y : 100.0000

Referencing a Unit

Set the coordinates for each vertex by referencing a processing unit in which the X and Y coordinates for each vertex have been registered.

Set a processing unit registered here.

- 1** In the Item tab area, click **Ref. setting.**
In the *Display* area, the current reference position will be displayed as the cross hair cursor.
- 2** In the *Method* area, select **Unit.**

Method

Numerical Unit

- 3** In the *Unit* area, select a processing unit registered.

- 4 Perform the next measurement.
The coordinates for each vertex will be displayed.

2-29-6 Results Settings (2D Code)

Results can be classified according to the judgement results.

- 1 In the Item tab area, click **Result setting**.
- 2 Register the character string that will be the reference for classification.

Setting item	Setting value	Description
Verification string	-	Specifies the comparison string to be judged as OK Up to 652 characters can be specified.
'*' and '?' are used as character data	<ul style="list-style-type: none"> • Checked • [Unchecked] 	Checked: '*' and '?' are treated as normal characters. Unchecked: '*' and '?' are treated as special characters. '*': Substitution for character string (with zero or more characters).

- 3 If necessary, set the quality display for the **Detail Result Pane**.

Setting item	Setting value [Factory default]	Description
Code quality display	<ul style="list-style-type: none"> • Checked • [Unchecked] 	Selects whether or not to display the integrated quality.



Additional Information

Since the displayed items are too many to the size of the Detail Result Pane, all of the items cannot be displayed depending on a code type displayed.
To display all of the items, change the size of the Detail Result Pane.
For details, refer to *Arranging Windows* in the *Vision System FH/FHV Series User's manual (Cat. No. Z365)*.

2-29-7 Output Parameters (2D Code)

Select how measurement results are output to an external device. This item can be changed if necessary. Normally, the factory default value will be used.

- 1 Click **Output parameter** in the Item Tab area.
- 2 Specify each of the following items.

Setting item	Setting value [Factory default]	Description
Reflect to overall judgment	<ul style="list-style-type: none"> • [ON] • OFF 	Enables choosing whether or not the judgement results of this processing unit is reflected in the scene overall judgment.
Character output	<ul style="list-style-type: none"> • Checked • [Unchecked] 	Sets whether or not to output character strings.
Communication output	<ul style="list-style-type: none"> • [RS-232C / RS-422] • Ethernet 	<p>Sets the output destination.</p> <p>The output destination is Serial (RS-232C / 422) or Serial (Ethernet) selected in the Communication of the System Settings. The setting of the IP address of the serial (Ethernet) output destination also follows the System Settings.</p> <p>*1</p> <p>For details, refer to <i>Non-procedure Communications</i> in the <i>Vision System FH/FHV Series User's Manual for Communications Settings (Cat. No. Z342)</i>.</p>
Header	<ul style="list-style-type: none"> • [None] • STX • ESC 	Selects the header for the communication output.
Footer	<ul style="list-style-type: none"> • [CR] • CR+LF • ETX • LF 	Selects the footer for the communication output.
FCS	<ul style="list-style-type: none"> • Available • [None] 	<p>Selects whether or not to output FCS (frame check sequence).</p> <p>FCS is created by calculating the exclusive OR of each byte in data and converting the result (8 bits) into two characters in ASCII code format.</p> <p>Adding the FCS to the output data enables communications to be more reliable.</p>
Reading character output		
Reading character output	<ul style="list-style-type: none"> • [Checked] • Unchecked 	Selects whether or not to output character strings read.
Output range specify	<ul style="list-style-type: none"> • Checked • [Unchecked] 	<p>Selects this when to specify the range of character strings to output.</p> <p>Range: 1 to 652</p>
Output range specify	1 to 652 [1] to [652]	<p>Sets the range of output character count.</p> <p>Range: 1 to 652</p>
Character count output	<ul style="list-style-type: none"> • Checked • [Unchecked] 	Selects whether or not to output the character count of the character string.
Character code size	<ul style="list-style-type: none"> • [2 bytes] • 4 bytes 	Selects the character code size for character output.
Code quality output	<ul style="list-style-type: none"> • [Checked] • Unchecked 	<p>Valid only when <i>DPM</i> is selected in the <i>Read mode</i> of the measurement parameter.</p> <p>Selects whether or not to output the 2D Code quality.</p>

Setting item	Setting value [Factory default]	Description
Output when reading error occurs		
Error character output	<ul style="list-style-type: none"> • Checked • [Unchecked] 	Selects whether or not to output the specified character string at a reading error occurred. When it is selected, the character string entered in the lower frame will be output. Up to 20 characters can be entered.
Error code output	<ul style="list-style-type: none"> • Checked • [Unchecked] 	Select whether or not to output error codes. Error codes are as follows. 0: Normal termination -1: 2D Code not found -3: Timeout -7: Terminated due to too much data

*1. RS-422 is unavailable in the FH/FHV series.

Character Output

Characters are output in the ASCII format as follows:

- When read successfully
Header + character count + code quality + reading characters + FCS + footer + delimiters
- When not read successfully
Header + error code + error characters + FCS + footer + delimiters

Item	Description
Header	What is specified for the <i>Headeris</i> output. (None may be specified.) None is output for PLC link.
Character count	This is output only when <i>Character count output</i> is specified. Only the reading characters are counted as part of the character count, and if <i>Output range specify</i> is specified, the character count of only that range is output. For example, if no character is present in the output range, such as when the read character count is 1 and the output range is 2 to 3, 0 will be output. If <i>Reading character outputis</i> not specified, 0 will be output. If kanji characters are included in the reading characters, one kanji character is counted as 1. (This is different from byte count.) The output can be switched between 2 bytes and 4 bytes. 0 is added to the left digit if the character count is less than the byte count (Example: 0010 for 10). "--" is output if the character count in 2-byte output reaches 100 or more.
Code quality	This is output only when the <i>Code quality output</i> is specified. The output format is "CxxxFxxxExxx". C represents the contrast, while F and E represent the focus and the cell recognition rate, respectively. xxx represents each value (0 to 100), and 0 is added to the left digit if the value is less than 3 digits (Example: 005 for 5).
Reading character	This is output only when the <i>Reading character output</i> is specified. If <i>Output range specify</i> is specified, only the characters of that range are output. For example, if no character is present in the output range, such as when the read character count is 1 and the output range is 2 to 3, no character will be output.
Error code	This is output only when <i>Error code outputis</i> specified.
Error character	This is output only when <i>Error character output</i> is specified.

Item	Description
FCS	This is output only when FCS is set to <i>Available</i> . The value obtained through an XOR in unit of bytes is output. The applicable range includes the character count, code quality, reading characters, error codes and error characters. 0 will be output if nothing that can be output is present in the applicable range. None is output for PLC link.
Footer	What is specified for the <i>Footer</i> is output. None is output for PLC link.
Delimiter	The delimiters specified in the system data are added only for serial communication non-procedure output.

Output of Character String in PLC Link

In PLC Link communication, if you check the **Character output** in the **Output parameter** tab, the character string and NULL(00 hex)+NULL(00 hex) are output to the data output area of PLC Link.

● Output Format

Take the following case as an example. Number of measurement is one. Reading character string is 32. Command: Read character strings 0123456789...UV, Command, Response, and Data Output area are as follows.

For details, refer to *Communicating with PLC Link, Command Details for PLC Link, EtherNet/IP, and EtherCAT in Vision System FH/FHV Series User's Manual for Communications Settings (Cat. No. Z342)*.



Additional Information

If no character string, no data will be output.

- Command (PLC to Sensor Controller)

Command Area		Description
Top Channel +3	Top Channel +2	
0010	1010	Performs one measurement.

- Response (Sensor Controller to PLC)

Response Area		Description
Top Channel	Data	
+2	1010	Command Code: Target command code is responded.
+3	0010	
+4	0000	Response code: Command execution result.
+5	0000	

- Data Output Area (Sensor Controller to PLC)

When read the 32 character strings (0123456789...UV), the result continues as follows. ASCII code data + NULL (00 hex) + NULL (00 hex)

Top channel	Name	Description
+0	1st character, 2nd character	3031 (ASCII code of the character 0, ASCII code of the character 1)

Top channel	Name	Description
+1	3rd character, 4th character	3233 (ASCII code of the character 2, ASCII code of the character 3)
:	:	:
+15	31st character, 32nd character	5556 (ASCII code of the character U, ASCII code of the character V)
+16	NULL, NULL	NULL (00 hex) + NULL (00 hex)

● How to get the character string

Perform the Data Output Request (DSA) and Data Output Completion (GATE) as in the case of Data Output.

All character string is included in one data. Thereby, Data Output Request (DSA) is performed once if there is one Character Inspection unit.

Output of Character String with Non-procedure Communications

Check the **Character output** in the **Output parameter** tab to output the character string with Non-procedure communication.

● Output Format

Take the following case as an example. Number of measurement is one. Reading character string is 32. Command: Read character strings 0123456789...UV, Command, Response, and Data Output area are as follows.

For details, refer to *Non-procedure Communications* and *MEASURE* or *M* in *Non-procedure Command Details* in *Vision System FH/FHV Series User's Manual for Communications Settings* (Cat. No. Z342).

- Command (PLC to Sensor Controller)

M E A S U R E ^{C_R} or M ^{C_R}

- Response (Sensor Controller to PLC)

O K ^{C_R}

0123456789...UV(Character string data) NULL(00 hex) ^{C_R}

Output of Character String with EtherNet/IP Message Communications

In EtherNet/IP message communication, output of character string is possible using UNITDATA command which acquires the measurement value. Outputs the character string data measured and NULL (00 hex).

For details, refer to *Communicating with the Sensor Controller with EtherNet/IP Message Communications*, *Non-procedure Communications* and *UNITDATA* or *UD* in *Non-procedure Command Details* in *Vision System FH/FHV Series User's Manual for Communications Settings* (Cat. No. Z342).

● Output Format

Take the following case as an example. Number of measurement is one. Reading character string is 32. Command: Read character strings 0123456789...UV, Command, Response, and Data Output area are as follows. Described example is only a part of Attribute.



Additional Information

- When character strings in multiple lines are output, change the external reference table No. of UNITDATA, and then read the character strings.
- Command (PLC to Sensor Controller)
Specify the command character string equivalent to a non-procedure command.
Attach NULL(00 hex) at the end of the character string. No line feed code is required.
The size of the send data includes the NULL(00 hex) at the end of the character string.

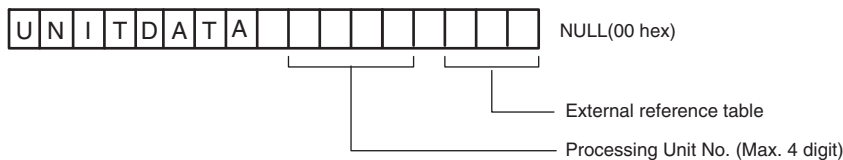

- Response (Sensor Controller to PLC)
Character string data equivalent to the Non-procedure command reception character string is returned.
NULL (00 hex) is inserted in the reception character string delimiter section.
The size of the reception data includes the final NULL(00 hex).

0123456789...UV(Character string data) NULL(00 hex) O(4F hex) K(4B hex) NULL(00 hex)

2-29-8 Output of Character String with Result Output (I/O) with Ether-Net/IP

Use the **Result Output (I/O)** processing unit to output the read string.

For details, refer to *Communicating by EtherNet/IP - Setting Output Data (Numerical Values and Character Strings)* in the *Vision System FH/FHV Series User's Manual for Communications Settings (Cat. No. Z342)*.

2-29-9 Output of Character String with Result Output (I/O) with Ether-CAT

Use the **Result Output (I/O)** processing unit to output the read string.

For details, refer to *EtherCAT Connections - Setting Output Data (Numerical Values and Character Strings)* in the *Vision System FH/FHV Series User's Manual for Communications Settings (Cat. No. Z342)*.

2-29-10 Output of Character String with Result Output (I/O) with PROFINET

Use the **Result Output (I/O)** processing unit to output the read string.

For details, refer to *Communicating by PROFINET - Setting Output Data (Numerical Values and Character Strings)* in the *Vision System FH/FHV Series User's Manual for Communications Settings (Cat. No. Z342)*.

2-29-11 Key Points for Test Measurement and Adjustment (2D Code)

The following content is displayed in the *Detail result* area as text.

Displayed item	Description
Judge	Judgment results 0: No judgment (unmeasured) 1: Judgment result OK -1: Judgment result NG -10: Error (image format mismatch) -11: Error (unregistered model) -12: Error (insufficient memory) -20: Error (other errors)
Index	Matched index after compared with the classification comparison character strings
Detected character count	No. of characters detected
Detected character string	Character strings detected
Cell recognition rate* ¹	Value that lets you check the correction rate. The recognition rate is higher when the ratio of corrected characters to the total number of characters in the code is lower.
Contrast* ¹	Indicates the contrast in a code. When the difference of contrast between light and shade in a code is bigger, the value of contrast become higher.
Focus* ¹	Indicates the focus of the image using the change of density at cell edges. When out of focus, the code cannot be read. When the cell edges are sharper, the value of Focus become higher.
Overall quality* ²	An overall quality grade for the read code. This is given the lowest value among all quality grades.
Decode* ²	A quality grade which shows whether the decode is successful or not.
Contrast* ²	A quality grade which shows the contrast. This becomes high when the difference between the highest and lowest brightness is large in a code region.
Modulation* ²	A quality grade which shows the brightness uniformity of cells.
Fixed pattern damage* ²	A quality grade which shows the damage level of Finder pattern, Timing pattern, and Quiet zone.
Axis non-uniformity* ²	A quality grade which shows the ratio of code width and height. This becomes high when a cell shape is close-to-square.
Grid non-uniformity* ²	A quality grade which shows the deviation of the grid intersections in the data area of the symbol which are compared with positions of the ideal grid in a theoretical perfect symbol.
Unused error correction* ²	A quality grade which shows the amount of available error correction in a symbol. The fewer the error-corrected words, the higher the grade. results in a higher grade.

Displayed item	Description
Print Growth ^{*2}	A quality grade which shows the size uniformity of black and white cells. The grade will be Print Growth X or Print Growth Y, whichever is lower.
Print Growth X ^{*2}	The better the size uniformity of black and white cells toward the X direction, the higher the grade.
Print Growth Y ^{*2}	The better the size uniformity of black and white cells toward the Y direction, the higher the grade.
Scan ^{*2}	-
Overall quality ^{*3}	An overall quality grade for the read code. This will be set to the lowest value among all quality grades.
Decode ^{*3}	A quality grade which shows whether the start pattern, stop pattern, or row indicator were successfully decoded, or not.
RAP symbol contrast ^{*3}	A quality grade which shows the contrast of the start pattern, stop pattern, or row indicator. The larger the difference between the highest and lowest brightness in a pattern region, the higher the grade.
RAP minimum reflectance ^{*3}	A quality grade which shows the contrast of the start pattern, stop pattern, or row indicator. Evaluate this with the lowest brightness in pattern region.
RAP minimum edge contrast ^{*3}	A quality grade which shows the contrast of the start pattern, stop pattern, or row indicator. Evaluate this with the lowest contrast between the bar and space.
RAP modulation ^{*3}	A quality grade which shows the brightness uniformity of the start pattern, stop pattern, or row indicator. Evaluate this with the ratio between the lowest edge contrast and the symbol contrast.
RAP defect ^{*3}	A quality grade which shows the brightness uniformity of the start pattern, stop pattern, or row indicator. Evaluate this with the level of the brightness uniformity between the bar and space.
RAP decodability ^{*3}	A quality grade which shows the printed accuracy of start pattern, stop pattern, or row indicator. The grade becomes high when the width dimension of the bar or space is close to the standard values.
RAP additional ^{*3}	A quality grade which shows whether or not there is a sufficient Quiet zone width for start pattern, stop pattern, or row indicator.
RAP overall quality ^{*3}	An overall quality grade for parts of the start pattern, stop pattern, or row indicator.
Code word yield ^{*3}	A grade quality which shows the efficiency to read the data by scanning a code. Evaluate this with the number of successfully decoded codes to the number of codes decoded when repeatedly scanning codes.
Unused error correction ^{*3}	A quality grade which shows the amount of available error correction in a symbol. The fewer the error-corrected words, the higher the grade. results in a higher grade.
Decodability ^{*3}	A quality grade which shows the printed accuracy of codewords. The grade becomes high when the width dimension of the bar or space is close to the standard values.
Defect ^{*3}	A quality grade which shows the brightness uniformity of the codewords. Evaluate this with the level of the brightness uniformity between the bar and space.
Modulation ^{*3}	A quality grade which shows the brightness uniformity of the cord words. Evaluate this with the ratio between the lowest edge contrast and the symbol contrast.

*1. Read mode: Only displayed in DPM mode and "Code quality display" is selected.

*2. Read mode: Displayed if it is standard, the code type is DataMattix and "Code quality display" is selected.

*3. Read mode: Displayed if it is standard, the code type is PDF417/MicroPDF417 and "Code quality display" is selected.

The grade code is displayed by an alphabetical notation followed by a numeric notation in parentheses, such as "A (4) to F.

**Additional Information**

When the reading mode is DPM, a red circle is displayed on the cell where the judgment of the white or black cell is corrected in the image display area.

Key Points for Adjustment (2D Code)

Adjust the setting parameters referring to the following points.

- **When codes cannot be read in correctly**

Parameter to be adjusted	Remedy
Region setting	Check whether there are codes to read in the measurement region.
Measurement parameter	Check if the settings, such as " <i>Code type</i> , <i>Code color</i> , <i>Code length</i> , and <i>Mirror setting</i> are specified correctly.
Timeout	Check to make sure that the specified time is not too short.

2-29-12 Measurement Results for Which Output Is Possible (2D Code)

The following values can be output using processing items related to result output. It is also possible to reference measurement values from calculation expressions and other processing units.

Measurement items	Character string	Description
Judge	JG	Judgment results 0: No judgment (unmeasured) 1: Judgment result OK -1: Judgment result NG -10: Error (image format mismatch) -11: Error (unregistered model) -12: Error (insufficient memory) -20: Error (other errors)
Number of decoded characters	DN	Char. count
Index	IDX	Index matched as the result of comparison with the classification comparison character strings
Cell recognition rate	CRR	Value that lets you check the correction rate. The recognition rate is higher when the ratio of corrected characters to the total number of characters in the code is lower.
Contrast	CT	Indicates the contrast in a code. When the difference of contrast between light and shade in a code is bigger, the value of contrast become higher.
Focus	FCS	Indicates the focus of the image using the change of density at cell edges. When out of focus, the code cannot be read. When the cell edges are sharper, the value of Focus become higher.
Overall quality (Standard: DM)	GDO	An overall quality grade for the read code. This is set to the lowest value among all quality grades.

Measurement items	Character string	Description
Decode (Standard: DM)	GD1	A quality grade which shows whether the decode is successful or not.
Contrast	GD2	A quality grade which shows the contrast. This becomes high when the difference between the highest and lowest brightness is large in a code region.
Modulation	GD3	A quality grade which shows the brightness uniformity of cells.
Fixed pattern damage	GD4	A quality grade which shows the damage level of Finder pattern, Timing pattern, and Quiet zone.
Axis non-uniformity	GD5	A quality grade which shows the ratio of code width and height. This becomes high when a cell shape is close-to-square.
Grid non-uniformity	GD6	A quality grade which shows the deviation of the grid intersections in the data area of the symbol which are compared with positions of the ideal grid in a theoretical perfect symbol.
Unused error correction	GD7	A quality grade that shows the amount of available error correction in a symbol. The fewer the error-corrected words, the higher the grade. results in a higher grade.
Print Growth	GD8	A quality grade which shows the uniformity of black and white cell sizes. The grade will be Print Growth X or Print Growth Y, whichever is lower.
Print Growth X	GD9	The better the uniformity of black and white cell sizes toward the X direction, the higher the grade.
Print Growth Y	GD10	The better the uniformity of black and white cell sizes toward the Y direction, the higher the grade.
RAP symbol contrast	GP2	A quality grade which shows the contrast of the start pattern, stop pattern, or row indicator. The larger the difference between the highest and lowest brightness in a pattern region, the higher the grade.
RAP minimum reflectance	GP3	A quality grade which shows the contrast of the start pattern, stop pattern, or row indicator. Evaluate this with the lowest brightness in a pattern region.
RAP minimum edge contrast	GP4	A quality grade which shows the contrast of the start pattern, stop pattern, or row indicator. Evaluate this with the lowest contrast between the bar and space.
RAP modulation	GP5	A quality grade which shows the brightness uniformity of the start pattern, stop pattern, or row indicator. Evaluate this with the ratio between the lowest edge contrast and the symbol contrast.
RAP defect	GP6	A quality grade which shows the brightness uniformity of the start pattern, stop pattern, or row indicator. Evaluate this with the level of the brightness uniformity between the bar and space.

Measurement items	Character string	Description
RAP decodability	GP7	A quality grade which shows the printed accuracy of start pattern, stop pattern, or row indicator. The grade becomes high when the width dimension of the bar or space is close to the standard values.
RAP additional	GP8	A quality grade which shows whether or not there is a sufficient Quiet zone width for start pattern, stop pattern, or row indicator.
RAP overall quality	GP9	An overall quality grade for the start pattern, stop pattern, or row indicator.
Code word yield	GP10	A grade quality which shows the efficiency to read the data by scanning a code. Evaluate this with the number of successfully decoded codes to the number of codes decoded when repeatedly scanning codes.
Unused error correction	GP11	A quality grade that shows the amount of available error correction in a symbol. The fewer the error-corrected words, the higher the grade. results in a higher grade.
Decodability	GP12	A quality grade which shows the printed accuracy of codewords. The grade becomes high when the width dimension of the bar or space is close to the standard values.
Defect	GP13	A quality grade which shows the brightness uniformity of the codewords. Evaluate this with the level of the brightness uniformity between the bar and space.
Modulation	GP14	A quality grade which shows the brightness uniformity of the codewords. Evaluate this with the ratio between the lowest edge contrast and the symbol contrast.
Measurement coordinate	X	Code center coordinate X of measurement result
Measurement coordinate	Y	Code center coordinate Y of measurement result
Angle θ	TH	Angle of measurement result
Ref. coordinate	SX	Reference coordinate X of code center
Ref. coordinate	SY	Reference coordinate Y of code center
Ref. angle	ST	Reference angle of code center
Upper left meas. position	MXA	X coordinate of upper left vertex of measurement result
Upper left meas. position	MYA	Y coordinate of upper left vertex of measurement result
Lower left meas. position	MXB	X coordinate of lower left vertex of measurement result
Lower left meas. position	MYB	Y coordinate of lower left vertex of measurement result
Lower right meas. position	MXC	X coordinate of lower right vertex of measurement result
Lower right meas. position	MYC	Y coordinate of lower right vertex of measurement result
Upper right meas. position	MXD	X coordinate of upper right vertex of measurement result
Upper right meas. position	MYD	Y coordinate of upper right vertex of measurement result

Measurement items	Character string	Description
Upper left ref. position	SXA	X coordinate of upper left vertex of reference position
Upper left ref. position	SYA	Y coordinate of upper left vertex of reference position
Lower left ref. position	SXB	X coordinate of lower left vertex of reference position
Lower left ref. position	SYB	Y coordinate of lower left vertex of reference position
Lower right ref. position	SXC	X coordinate of lower right vertex of reference position
Lower right ref. position	SYC	Y coordinate of lower right vertex of reference position
Upper right ref. position	SXD	X coordinate of upper right vertex of reference position
Upper right ref. position	SYD	Y coordinate of upper right vertex of reference position

2-29-13 External Reference Tables (2D Code)

No.	Data name	Data ident	Set/Get	Data range
0	Judge	Judge	Get only	0: No judgment (unmeasured), 1: Judgment result OK, -1: Judgment result NG, -10: Error (image format mismatch), -11: Error (unregistered model), -12: Error (insufficient memory), -20: Error (other errors)
6	Number of decoded characters	decodeCharNum	Get only	-
7	Decoded characters	decodeCharStr	Get only	Character string
8	Index	index	Get only	-
9	Error code	errCode	Get only	0: Normal, -1: Not found 2DCode, -3: Timeout, -7: Too much data to finish
10	Output String	outputCharStr	Get only	Character string
18	Read ratio	readRatio	Get only	0 to 100
19	Contrast	contrast	Get only	0 to 100
20	Focus	focus	Get only	0 to 100
21	Overall quality(Normal:DM)	overallQualityD	Get only	0 to 4
22	Decode(Normal:DM)	decodeD	Get only	0 to 4
23	Contrast	contrastD	Get only	0 to 4
24	Modulation	modulationD	Get only	0 to 4
25	Fixed pattern damage	fixedPatternDamage	Get only	0 to 4
26	Axial nonuniformity	axialNonuniformity	Get only	0 to 4
27	Grid nonuniformity	gridNonuniformity	Get only	0 to 4
28	Unused error correction	unusedErrorD	Get only	0 to 4
29	Print Scale	printScale	Get only	0 to 4
30	Print Scale X	printScaleX	Get only	0 to 4
31	Print Scale Y	printScaleY	Get only	0 to 4
33	Overall quality(Normal:PDF417/MicroPDF)	overallQualityPDF	Get only	0 to 4

No.	Data name	Data ident	Set/Get	Data range
34	Decode(Normal:PDF417/ MicroPDF)	decodePDF	Get only	0 to 4
35	RAP contrast	rapContrast	Get only	0 to 4
36	RAP reflectance	rapReflect	Get only	0 to 4
37	RAP edge contrast	rapEdgeContrast	Get only	0 to 4
38	RAP modulation	rapModulation	Get only	0 to 4
39	RAP defect	rapDefect	Get only	0 to 4
40	RAP decodability	rapDecodability	Get only	0 to 4
41	RAP additional	rapAddionail	Get only	0 to 4
42	RAP overall quality	rapOverall	Get only	0 to 4
43	Code word yield	codeWordYield	Get only	0 to 4
44	Unused error correction	unusedErrorPDF	Get only	0 to 4
45	Decodability	decodabilityPDF	Get only	0 to 4
46	Defect	defectPDF	Get only	0 to 4
47	Modulation	modulationPDF	Get only	0 to 4
50	Position X	positionX	Get only	-
51	Position Y	positionY	Get only	-
52	Angle	angle	Get only	-
53	Reference positionX	referenceX	Get only	-
54	Reference positionY	referenceY	Get only	-
55	Reference angle	referenceAngle	Get only	-
70	Upper left reference position X	referenceSXA	Get only	-99,999.9999 to 99,999.9999
71	Upper left reference position Y	referenceSYA	Get only	-99,999.9999 to 99,999.9999
72	Lower left reference position X	referenceSXB	Get only	-99,999.9999 to 99,999.9999
73	Lower left reference position Y	referenceSYB	Get only	-99,999.9999 to 99,999.9999
74	Lower right reference position X	referenceSXC	Get only	-99,999.9999 to 99,999.9999
75	Lower right reference position Y	referenceSYC	Get only	-99,999.9999 to 99,999.9999
76	Upper right reference position X	referenceSXD	Get only	-99,999.9999 to 99,999.9999
77	Upper right reference position Y	referenceSYD	Get only	-99,999.9999 to 99,999.9999
80	GS1 flag	gs1Flag	Get only	0:Normal code 1:GS1 code
90	Upper left position X	positionMXA	Get only	-99,999 to 99,999
91	Upper left position Y	positionMYA	Get only	-99,999 to 99,999
92	Lower left position X	positionMXB	Get only	-99,999 to 99,999
93	Lower left position Y	positionMYB	Get only	-99,999 to 99,999
94	Lower right position X	positionMXC	Get only	-99,999 to 99,999
95	Lower right position Y	positionMYC	Get only	-99,999 to 99,999

No.	Data name	Data ident	Set/Get	Data range
96	Upper right position X	positionMXD	Get only	-99,999 to 99,999
97	Upper right position Y	positionMYD	Get only	-99,999 to 99,999
103	Reflect to overall judgement	overallJudge	Set/Get	0:ON 1:OFF
107	Reference X	referencePosX	Set/Get	0 to 99,999.9999
108	Reference Y	referencePosY	Set/Get	0 to 99,999.9999
109	Reference angle	referencePosAngle	Set/Get	-180.0000 to 180.0000
110	Upper left reference X	referencePosSXA	Set/Get	0 to 99,999.9999
111	Upper left reference Y	referencePosSYA	Set/Get	0 to 99,999.9999
112	Lower left reference X	referencePosSXB	Set/Get	0 to 99,999.9999
113	Lower left reference Y	referencePosSYB	Set/Get	0 to 99,999.9999
114	Lower right reference X	referencePosSXC	Set/Get	0 to 99,999.9999
115	Lower right reference Y	referencePosSYC	Set/Get	0 to 99,999.9999
116	Upper right reference X	referencePosSXD	Set/Get	0 to 99,999.9999
117	Upper right reference Y	referencePosSYD	Set/Get	0 to 99,999.9999
120	Code type	code_type	Set/Get	Normal (0: DataMatrix, 1: QRCode, 2: MicroQR, 3: PDF417, 4: MicroPDF) DPM (0: Auto, 1: DataMatrix,, 2: QRCode)
121	Code color	code_color	Set/Get	0: Auto, 1: Black, 2: White
122	Square size	dm_squSize	Set/Get	0: Auto, 1: 10x10, 2: 12x12, to 16: 64x64
123	Rectangle size	dm_recSize	Set/Get	0: Auto, 1: 8x18, 2: 8x32, to 6: 16x48
124	QR size	qr_size	Set/Get	0: Auto, 1: 21x21, 2: 25x25, to 10: 57x57
125	DM shape	dm_shape	Set/Get	0: Auto, 1: DM Square, 2: DM Rectangle
126	QR shape	qr_shape	Set/Get	0: Auto, 1: Square
127	Code length	code_length	Set/Get	50 to 2,448
128	Mirror setting	mirrorimage	Set/Get	0: Auto, 1: Normal, 2: Reverse
129	QR model	qr_model	Set/Get	0: Auto, 1: Model 1, 2: Model 2
130	QR ECC level	qr_ecclevel	Set/Get	0: Auto, 1: M, 2: L, 3: H, 4: Q
131	Timeout	timeout	Set/Get	50 to 99,999
132	Speed mode	speedmode	Set/Get	0: Fast, 1: Precise
133	Flag of character output	out_char	Set/Get	0: Not output, 1: Output

No.	Data name	Data ident	Set/Get	Data range
134	Output range	out_rng	Set/Get	0:Not set 1:Set
135	Output terminator	out_last	Set/Get	1 to 652
136	Output starter	out_first	Set/Get	1 to 652
137	Output device	outputDevice	Set/Get	0: RS-232C/RS-422 *1 1: Ethernet
138	Character output on NG	errorOut	Set/Get	0: Not output, 1: Output
139	Error output message	errorMessage	Set/Get	Character string
140	Code length auto setting	code_lengthAuto	Set/Get	1: Auto, 0: Use specified code length
141	Error code output on NG	out_ng	Set/Get	0: Not output, 1: Output
142	Magnify level	magnifyLevel	Set/Get	0 to 4
143	Magnify level auto	magnifyAuto	Set/Get	0: OFF, 1: ON
144	Quiet zone check	qz_check	Set/Get	0: OFF, 1: ON
145	Integrated quality	lowerOverallGrade	Set/Get	0.0 to 4.0
146	Read mode	readMode	Set/Get	0: Normal, 1: DPM
147	MicroQR size	microqr_size	Set/Get	0: Auto, 1: 11x11, 2: 13x13, 3: 15x15, 4: 17x17
148	ECC level	microqr_ecclevel	Set/Get	0: Auto, 1: L, 2: M, 3: Q
170	Upper limit for character number	upperCharNum	Set/Get	0 to 652
171	Lower limit for character number	lowerCharNum	Set/Get	0 to 652
172	Judge compare string	judgeCompString	Set/Get	Character string
173	Wildcard usage flag for judgement	judgeCompWildcard	Set/Get	0: '*' and '?' are treated as wildcard, 1: '*' and '?' are treated as string
174	Wildcard usage flag for classification	compWildcard	Set/Get	0: '*' and '?' are treated as wildcard, 1: '*' and '?' are treated as string
175	Result display character	resultDisp	Set/Get	0: OFF, 1: ON
176	Display color	dispColor	Set/Get	0: Black, 1: White, 2: Red, 3: Green, 4: Blue
177	Display size	dispSize	Set/Get	10 to 200
178	Header	rsHeader	Set/Get	0: None, 1: STX, 2: ESC
179	Footer	rsFooter	Set/Get	0: CR, 1: CR+LF, 2: ETX, 3: LF
180	FCS flag	fcsFlag	Set/Get	0: OFF, 1: ON
181	Flag of output character number	countCharFlag	Set/Get	0: None, 1: 2 bytes, 2: 4 bytes
182	Output code quality	qualityFlag	Set/Get	0: Not output, 1: Output
183	Display code quality	DispqualityFlag	Set/Get	0: OFF, 1: ON
184	Flag of IO output character	outcharIOFlag	Set/Get	0: OFF, 1: ON

No.	Data name	Data ident	Set/Get	Data range
185	Replace GS by any string	replaceGS	Set/Get	0: OFF, 1: ON
186	Replace string	replaceString	Set/Get	Character string
231	Setting unit of reference coordinate	refUnitNo	Set/Get	-1 to 9,999
232	Setting type of reference coordinate	refSettingType	Set/Get	0: Numerical, 1: Unit
233	Update the reference angle	updateAngleFlg	Set/Get	0: Not update, 1: Update
236	Use point coordinate before scroll(Central reference setting)	beforeScrollRefMode	Set/Get	0: Not use, 1: Use
237	Position X before scroll	beforeScrollRefPosX	Get only	-99,999.9999 to 99,999.9999
238	Position Y before scroll	beforeScrollRefPosY	Get only	-99,999.9999 to 99,999.9999
239	Angle before scroll	beforeScrollRefAngle	Get only	-180 to 180
240	Upper left position X before scroll	beforeScrollRefPosSXA	Get only	-99,999.9999 to 99,999.9999
241	Upper left position Y before scroll	beforeScrollRefPosSYA	Get only	-99,999.9999 to 99,999.9999
242	Lower left position X before scroll	beforeScrollRefPosSXB	Get only	-99,999.9999 to 99,999.9999
243	Lower left position Y before scroll	beforeScrollRefPosSYB	Get only	-99,999.9999 to 99,999.9999
244	Lower right position X before scroll	beforeScrollRefPosSXC	Get only	-99,999.9999 to 99,999.9999
245	Lower right position Y before scroll	beforeScrollRefPosSYC	Get only	-99,999.9999 to 99,999.9999
246	Upper right position X before scroll	beforeScrollRefPosSXD	Get only	-99,999.9999 to 99,999.9999
247	Upper right position Y before scroll	beforeScrollRefPosSYD	Get only	-99,999.9999 to 99,999.9999
248	Setting unit of Upper left reference coordinate	refAUnitNo	Set/Get	-1 to 9,999
249	Setting unit of Lower left reference coordinate	refBUnitNo	Set/Get	-1 to 9,999
250	Setting unit of Lower right reference coordinate	refCUnitNo	Set/Get	-1 to 9,999
251	Setting unit of Upper right reference coordinate	refDUnitNo	Set/Get	-1 to 9,999
252	Setting type of vertex reference coordinate	VerRefSettingType	Set/Get	0: Numerical, 1: Unit
253	Use point coordinate before scroll(Vertices reference setting)	beforeScrollVerRefMode	Set/Get	0: Not use, 1: Use

No.	Data name	Data ident	Set/Get	Data range
300+N (N=0 to 35)	Compare string	compString00 to compString35	Set/Get	Character string
90,000	figure0 Count	figArea0_count	Set/Get	1
90,001	figure0 Type	figArea0_fig0_type	Set/Get	8: Rectangle
90,002	figure0 mode	figArea0_fig0_mode	Set/Get	0: OR
90,014	figure0 Rectangle Upper left position X	figAr- ea0_fig0_box_X0	Set/Get	-99,999 to 99,999
90,015	figure0 Rectangle Upper left position Y	figAr- ea0_fig0_box_Y0	Set/Get	-99,999 to 99,999
90,016	figure0 Rectangle Lower right position X	figAr- ea0_fig0_box_X1	Set/Get	-99,999 to 99,999
90,017	figure0 Rectangle Lower right position Y	figAr- ea0_fig0_box_Y1	Set/Get	-99,999 to 99,999
90,099	figure0 Update	figArea0_update	Set only	1: Update

*1. RS-422 is unavailable in the FH/FHV series.

2-30 2D Code II

This processing item reads DataMatrix that is a type of 2D Code.

This processing item has function optimized for reading DataMatrix of 2D code.

Used in the Following Case

To classify with 2D Code (DataMatrix)

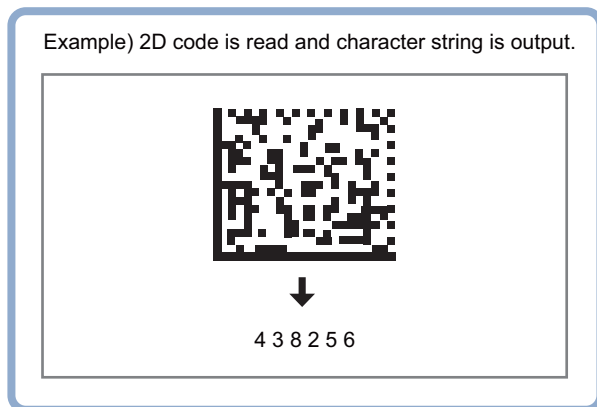

Precautions for Correct Use

- 2D Code including Japanese is not supported. Only 2D Code configured with ASC II code is supported.
- Processing is different for color images and monochrome images. When the camera type used in the previous setup was changed to color or monochrome type, perform the settings again.
- Capture 2D Code so that the cell size on the image will be equal or larger.
Reading only: 2 pixels
Calculating printing quality: 5 pixels

2-30-1 Settings Flow (2D Code II)

To set 2D Code II, follow the steps below.

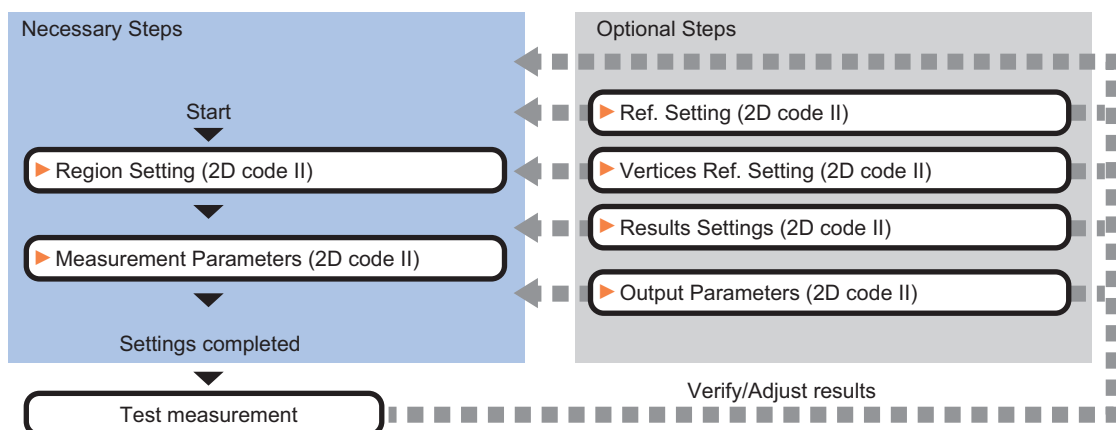

List of 2D Code II Items

Item	Description
Region setting	Sets the measurement area. It is possible to target the entire screen, but restricting the range can shorten the processing time. <i>2-30-2 Region Setting (2D Code II) on page 2-457</i>
Measurement parameter	Sets processing conditions for measurement and judgment conditions for measurement results. Sets a code type, and the number of characters to judge as OK. <i>2-30-3 Measurement Parameters (2D Code II) on page 2-457</i>
Ref. setting	Sets the code center coordinates and code angle. <i>2-30-4 Reference Settings (2D Code II) on page 2-460</i>
Vertices Ref. Setting	Sets the coordinates for each vertex of the code. <i>2-30-5 Vertices Reference Setting (2D Code II) on page 2-462</i>
Result setting	Sets the measurement results. Judgment results can be classified. <i>2-30-6 Results Settings (2D Code II) on page 2-464</i>
Output parameter	This item can be changed as necessary. Normally, the factory default value will be used. <i>2-30-7 Output Parameters (2D Code II) on page 2-464</i>

2-30-2 Region Setting (2D Code II)

Specify the area to search 2D Code with a rectangular.
Reducing the measurement range shortens the processing time.



Precautions for Correct Use

Set the measurement region so that only one 2D Code is included.
If there are more than one 2D Code in the measurement region, measurement may not be performed properly.

- 1** In the Item tab area, click **Region setting**.
- 2** Click **Edit**.
The *Figure Setting* area is displayed.
- 3** Specify the area to search 2D Code.
The rectangle covering the entire screen is set. Adjust the size and position of the rectangle.
- 4** Click **OK** in the *Figure setting* area.
 - **OK**: Changes the settings and returns to the previous menu.
 - **Cancel**: Changes are discarded. Returns to the previous menu.
 - **Apply**: Updates the settings without leaving edit window.

2-30-3 Measurement Parameters (2D Code II)

This item specifies the judgement conditions for measurement conditions and measurement results.
When the [Teaching] button is clicked, detailed settings are set automatically.

If you then click the [Measurement] button, measurement is executed, the detected 2D Code region is displayed on the image and the measurement results are displayed as measurement value of the judgement condition.

If measurement cannot be carried out successfully with this procedure, adjust the parameters shown below.

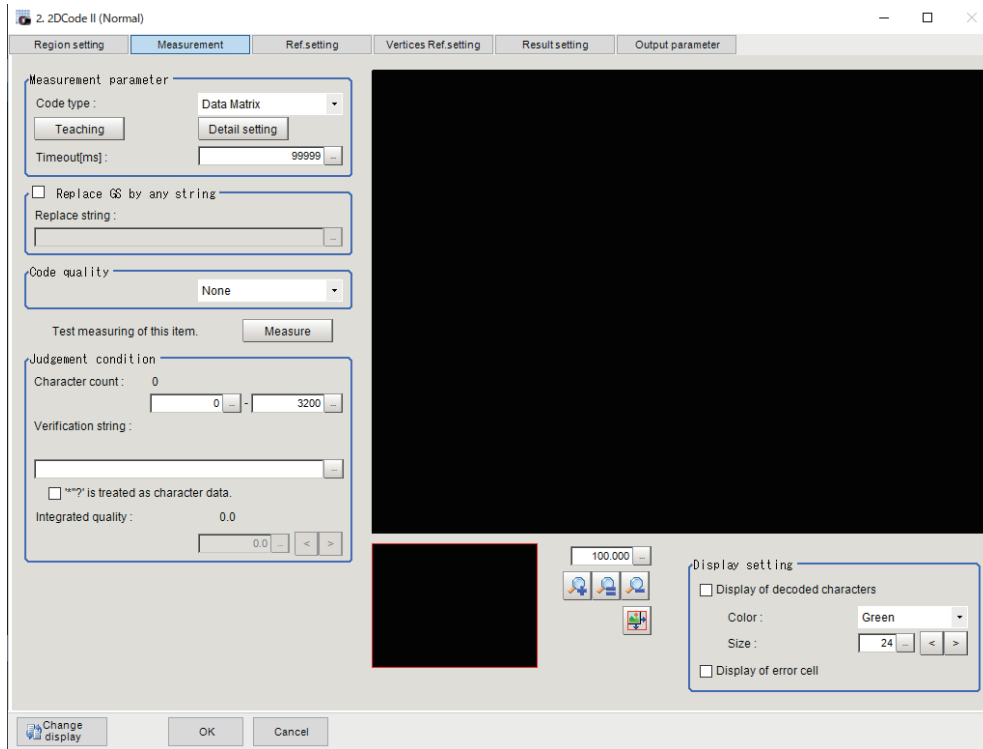

1 In the Item Tab area, click **Measurement**.

2 To teach, click **Teaching**.
The detailed settings are set automatically.

Setting item	Setting value [Factory default]	Description
Timeout	10 to 99,999 [99,999]	Stop and terminate the process if measurement for this processing item cannot be completed within the specified time period. Note that the actual timeout time may be longer than the specified time period.

3 When making the detailed settings, click **Detail setting** and set each item.

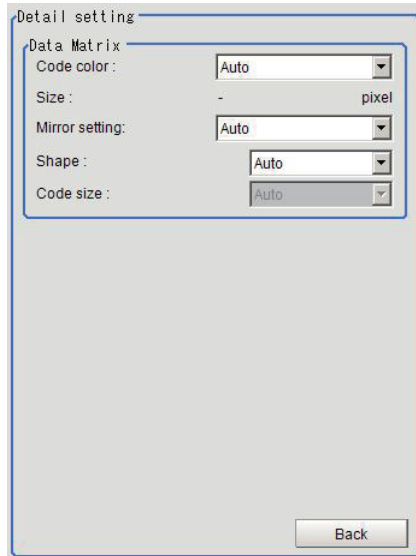

Setting item	Setting value [Factory default]	Description
Code color	<ul style="list-style-type: none"> • [Auto] • Black • White 	Selects the color of the 2D Code to read. <ul style="list-style-type: none"> • Auto: Select this for automatic discrimination. • Black: Select this for black 2D Code with a white background. • White: Select this for white 2D Code with a black background.
Size	-	Display an average value based on cell longitudinal and lateral sizes calculated by performing "Teaching".
Mirror setting	<ul style="list-style-type: none"> • [Auto] • Normal • Reverse 	Selects whether or not to reverse the image horizontally.
Shape	<ul style="list-style-type: none"> • [Auto] • Square • Rectangle 	Selects the shape of DataMatrix.
Code size	For <i>Auto</i> : <ul style="list-style-type: none"> • [Auto] For <i>Square</i> : <ul style="list-style-type: none"> • [Auto] • 10×10 • 12×12 • : • 144×144 For <i>Rectangle</i> : <ul style="list-style-type: none"> • [Auto] • 8×18 • 8×32 • : • 16×48 	Selects the size of DataMatrix.

- 4** To read codes containing group separators, set a group separator replacement condition.

Setting item	Setting value [Factory default]	Description
Replace the GS (Group Separator) with a specified character string	<ul style="list-style-type: none"> • Checked • [Unchecked] 	Places a check here to replace each GS (Group Separator) with a specified character string.
Replacement character string	-	Sets the character string to replace GS with.

5 Set the Code Quality.

Setting item	Setting value [Factory default]	Description
Code quality	<ul style="list-style-type: none"> • [None] • ISO/IEC 15415 • ISO/IEC TR29158 	Selects the quality standard to apply

6 When the setting has been changed, click [Measure] to verify whether measurements can be made correctly.

Setting item	Setting value	Description
Character count	0 to 3,200	Specifies the character count to be judged as OK.
Verification string	-	Specifies the comparison string to be judged as OK Up to 3,200 characters can be specified.
** and '?' are used as character data	<ul style="list-style-type: none"> • Checked • [Unchecked] 	Checked: '*' and '?' are treated as normal characters. Unchecked: '*' and '?' are treated as special characters. *': Substitution for character string (with zero or more characters).
Integrated quality (lower limit value)	0.0 to 4.0 [0.0]	Specifies the integrated quality to be judged as OK.

7 Set the display conditions for decoded characters.

Setting item	Setting value [Factory default]	Description
Display of decoded characters	<ul style="list-style-type: none"> • Checked • [Unchecked] 	Places a check here when displaying the decoded characters.
Color	<ul style="list-style-type: none"> • Black • White • Red • [Green] • Blue 	Specifies the color for displayed characters.
Size	10 to 200 [24]	Specifies the size of displayed characters.
Display of error cell	<ul style="list-style-type: none"> • Checked • [Unchecked] 	Places a check here when displaying cells with an error detected.

2-30-4 Reference Settings (2D Code II)

Set a center position and the angle for a 2D Code.

There are two setting methods: specifying directly or referencing a unit.

Specifying Directly

Click a position on the image you want to use as a reference position, or input coordinate data for that point.

- 1 In the Item tab area, click **Ref. setting**.
In the *Display* area, the current reference position will be displayed as the crosshair cursor.

- 2 In the *Method* area, select *Numerical*.

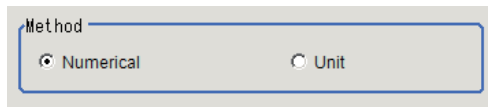

- 3 Click the position to be set as the reference.



Additional Information

Displaying the image enlarged makes this clicking easier.

For details, refer to *Appendixes Basic Knowledge about Operations Using the Zoom Function* in the *Vision System FH/FHV Series User's Manual* (Cat. No. Z365).

- 4 Make fine adjustments using numeric value inputs or the arrow buttons as required.

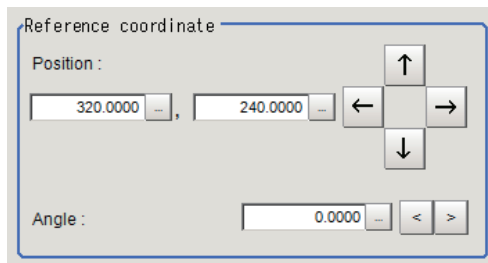

- 5 Set the reference angle with a numeric value.

- 6 To remeasure on the displayed image and set the reference, click **Measure ref.**.
To update the reference angle at the time of reference measurement, place a check at *Update the angle when measure ref.*

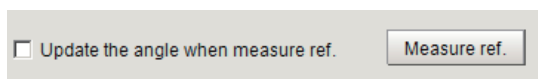

- 7 To use data before position compensation for the reference setting coordinates, place a check at *Use point coordinate before scroll*.

Use point coordinate before scroll

Position X : 320.0000
 Position Y : 240.0000
 Angle : 0.0000



Precautions for Correct Use

If you check *Use point coordinate before scroll*, do not use the following processing items. Otherwise, correct search results cannot be obtained.

- Precise Calibration
- Calibration Data Reference

Referencing a Unit

Set a reference by referencing a detection point unit with registered X coordinate, Y coordinate and angle data.

- 1 In the Item tab area, click **Ref. setting**.
In the *Display* area, the current reference position will be displayed as the crosshair cursor.
- 2 In the *Method* area, select *Unit*.

Method

Numerical Unit

- 3 In the *Unit* area, select a detection point unit in the scene.

Unit

17.Detection Point

Performing the next measurement will display the reference.

2-30-5 Vertices Reference Setting (2D Code II)

Set coordinates for each vertex of a 2D Code. The coordinates for each vertex do not correspond to camera coordinates and are determined by a shape of the 2D Code.

There are two setting method: specifying directly and referencing a unit.

Specifying Directly

Click each vertex position o the image or input the coordinate data for it.

- 1 In the Item tab area, click **Vertices Ref. setting**.
- 2 In the *Display* area, the current each vertex position will be displayed with a box.

- 3** In the *Method* area, select **Numerical**.

Method

Numerical Unit

- 4** Drag and drop the box on the each vertex position.



Additional Information

Displaying the image enlarged makes this clicking easier.

For details, refer to *Appendixes Basic Knowledge about Operations Using the Zoom Function in the Vision System FH/FHV Series User's Manual (Cat. No. Z365)*.

- 5** Adjust finely by inputting numerical value or using the arrows as necessary.

Position	Set coordinates
Upper left Reference	100.0000,100.0000
Lower left Reference	100.0000,300.0000
Lower right Reference	300.0000,300.0000
Upper right Reference	300.0000,100.0000

Position : Upper left Reference

Reference X : < >

Reference Y : < >

- 6** When to set the coordinates for each vertex by remeasuring the currently displayed image, click **Measure ref.**

Measure ref.

- 7** When to use them before position compensation as the coordinates for each vertex, place a check to *Use the point coordinate before scroll*.

Use point coordinate before scroll

Upper left Reference X : 100.0000

Upper left Reference Y : 100.0000

Lower left Reference X : 100.0000

Lower left Reference Y : 300.0000

Lower right Reference X : 300.0000

Lower right Reference Y : 300.0000

Upper right Reference X : 300.0000

Upper right Reference Y : 100.0000

Referencing a Unit

Set the coordinates for each vertex by referencing a processing unit in which the X and Y coordinates for each vertex have been registered.

Set a processing unit registered here.

- 1** In the Item tab area, click **Ref. setting**.
In the *Display* are, the current reference position will be displayed as the cross hair cursor.
- 2** In the *Method* area, select **Unit**.

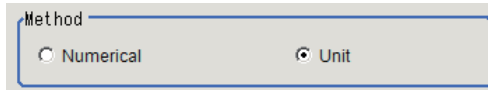

- 3** In the *Unit* area, select a processing unit registered.

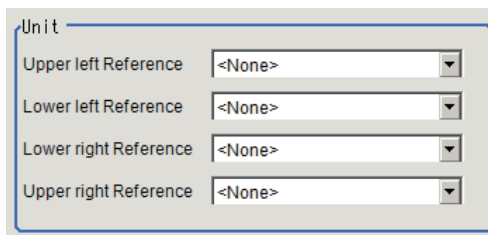

- 4** Perform the next measurement.
The coordinates for each vertex will be displayed.

2-30-6 Results Settings (2D Code II)

Results can be classified according to the judgement results.

- 1** In the Item tab area, click **Result setting**.
- 2** Register the character string that will be the reference for classification.

Setting item	Setting value [Factory default]	Description
Verification string	-	Specifies the comparison string to be judged as OK Up to 3,200 characters can be specified.
'*' and '?' are used as character data	<ul style="list-style-type: none"> • Checked • [Unchecked] 	Checked: '*' and '?' are treated as normal characters. Unchecked: '*' and '?' are treated as special characters. '*': Substitution for character string (with zero or more characters).

2-30-7 Output Parameters (2D Code II)

Select how measurement results are output to an external device. This item can be changed if necessary. Normally, the factory default value will be used.

- 1** Click **Output parameter** in the Item Tab area.
- 2** Specify each of the following items.

Setting item	Setting value [Factory default]	Description
Reflect to overall judgment	<ul style="list-style-type: none"> [ON] OFF 	Enables choosing whether or not the judgement results of this processing unit is reflected in the scene overall judgment.
Reading character output		
Reading character output	<ul style="list-style-type: none"> [Checked] Unchecked 	Selects whether or not to output character strings read.
Output range specify	<ul style="list-style-type: none"> Checked [Unchecked] 	Selects this when to specify the range of character strings to output. Range: 1 to 3200
Output range specify	1 to 3200 [1] to [3200]	Sets the range of output character count. Range: 1 to 3200
Character count output	<ul style="list-style-type: none"> Checked [Unchecked] 	Selects whether or not to output the character count of the character string.
Character code size	<ul style="list-style-type: none"> [2 bytes] 4 bytes 	Selects the character code size for character output.
Code quality output	<ul style="list-style-type: none"> [Checked] Unchecked 	Selects whether or not to output the 2D Code quality when <i>Code Quality</i> is set in the Measurement parameter.
Output when reading error occurs		
Error character output	<ul style="list-style-type: none"> Checked [Unchecked] 	Selects whether or not to output the specified character string at a reading error occurred. When it is selected, the character string entered in the lower frame will be output. Up to 20 characters can be entered.
Error code output	<ul style="list-style-type: none"> Checked [Unchecked] 	Select whether or not to output error codes. Error codes are as follows. 0: Normal termination -1: 2D Code not found -3: Timeout -7: Terminated due to too much data

Output of Character String with Result Output (I/O) with PLC Link

Use the **Result Output (I/O)** processing unit to output the read string.

For details, refer to *Communicating by PLC Link - Setting Output Data (Numerical Values and Character Strings)* in the *Vision System FH/FHV Series User's Manual for Communications Settings (Cat. No. Z342)*.

Output of Character String with Result Output (Message) with Non-procedure Communications

Use the **Result Output (Message)** processing unit to output the read string.

For details, refer to *Non-procedure Communications - Setting Output Data (Numerical Values and Character Strings)* in the *Vision System FH/FHV Series User's Manual for Communications Settings (Cat. No. Z342)*.

Output of Character String with Result Output (I/O) with EtherNet/IP

Use the **Result Output (I/O)** processing unit to output the read string.

For details, refer to *Communicating by EtherNet/IP - Setting Output Data (Numerical Values and Character Strings)* in the *Vision System FH/FHV Series User's Manual for Communications Settings* (Cat. No. Z342).

Output of Character String with Result Output (I/O) with EtherCAT

Use the **Result Output (I/O)** processing unit to output the read string.

For details, refer to *EtherCAT Connections - Setting Output Data (Numerical Values and Character Strings)* in the *Vision System FH/FHV Series User's Manual for Communications Settings* (Cat. No. Z342).

Output of Character String with Result Output (I/O) with PROFINET

Use the **Result Output (I/O)** processing unit to output the read string.

For details, refer to *Communicating by PROFINET - Setting Output Data (Numerical Values and Character Strings)* in the *Vision System FH/FHV Series User's Manual for Communications Settings* (Cat. No. Z342).

2-30-8 Key Points for Test Measurement and Adjustment (2D Code II)

The following content is displayed in the *Detail result* area as text.

Displayed item	Description
Judge	Judgment results 0: No judgment (unmeasured) 1: Judgment result OK -1: Judgment result NG -10: Error (image format mismatch) -11: Error (unregistered model) -12: Error (insufficient memory) -20: Error (other errors)
Index	Matched index after compared with the classification comparison character strings
Detected character count	No. of characters detected
Detected character string	Character strings detected
Overall quality ^{2-30-8 Key Points for Test Measurement and Adjustment (2D Code II) on page 2-466^{*2}}	An overall quality grade for the read code. This is s the lowest value among all quality grades.
Decode ^{2-30-8 Key Points for Test Measurement and Adjustment (2D Code II) on page 2-466^{*2}}	A quality grade which shows whether the decode is successful or not.
Contrast ^{*1}	A quality grade which shows the contrast.
Contrast ^{*2}	This becomes high when the difference between the highest and lowest brightness is large in a code region.

Displayed item	Description
Modulation* ¹	A quality grade which shows the brightness uniformity of cells.
Modulation* ²	
Fixed pattern damage 2-30-8 Key Points for Test Measurement and Adjustment (2D Code II) on page 2-466* ²	A quality grade which shows the damage level of Finder pattern, Timing pattern, and Quiet zone.
Axis non-uniformity 2-30-8 Key Points for Test Measurement and Adjustment (2D Code II) on page 2-466* ²	A quality grade which shows the ratio of code width and height. This becomes high when a cell shape is close-to-square.
Grid non-uniformity 2-30-8 Key Points for Test Measurement and Adjustment (2D Code II) on page 2-466* ²	A quality grade which shows the deviation of the grid intersections in the data area of the symbol which are compared with positions of the ideal grid in a theoretical perfect symbol.
Unused error correction 2-30-8 Key Points for Test Measurement and Adjustment (2D Code II) on page 2-466* ²	A quality grade that shows the amount of available error correction in a symbol. The fewer the error-corrected words, the higher the grade. results in a higher grade.
Reflectance margin* ²	A quality grade which shows the margin of reflectance.
Print scale 2-30-8 Key Points for Test Measurement and Adjustment (2D Code II) on page 2-466* ²	A quality grade which shows the uniformity of black and white cell sizes. The grade will be Print Growth X or Print Growth Y, whichever is lower.
Print scale X 2-30-8 Key Points for Test Measurement and Adjustment (2D Code II) on page 2-466* ²	The better the uniformity of black and white cell sizes toward the X direction, the higher the grade.
Print scale Y 2-30-8 Key Points for Test Measurement and Adjustment (2D Code II) on page 2-466* ²	The better the uniformity of black and white cell sizes toward the Y direction, the higher the grade.

*1. Displayed if **Measurement** tab -**Code quality** is set to *ISO/IEC TR29158*.

*2. Displayed if **Measurement** tab -**Code quality** is set to *ISO/IEC 15415*.

The grade code is displayed by an alphabetical notation followed by a numeric notation in parentheses, such as "A (4) to F.



Additional Information

When **Measurement** tab - **Display of error cell** is checked, a red circle is displayed on the cell where the judgment of the white or black cell is corrected in the image display area.

Key Points for Adjustment (2D Code II)

Adjust the setting parameters referring to the following points.

● When codes cannot be read in correctly

Parameter to be adjusted	Remedy
Region setting	Check whether there are codes to read in the measurement region.
Measurement parameter	Check if the settings, such as "Code type, Code color, Code length, and Mirror setting" are specified correctly.
Timeout	Check to make sure that the specified time is not too short.



Additional Information

If the code size is too smaller or larger, it may not be recognized.

2-30-9 Measurement Results for Which Output Is Possible (2D Code II)

The following values can be output using processing items related to result output. It is also possible to reference measurement values from calculation expressions and other processing units.

Measurement items	Character string	Description
Judge	JG	Judgment results 0: No judgment (unmeasured) 1: Judgment result OK -1: Judgment result NG -10: Error (image format mismatch) -11: Error (unregistered model) -12: Error (insufficient memory) -20: Error (other errors)
Number of decoded characters	DN	Char. count
Index	IDX	Index matched as the result of comparison with the classification comparison character strings
Cell recognition rate	CRR	The rate is calculated based on the "the number of error code word to be correctable", which is determined by the size and the error correction level, and the number of error code words that are actually corrected. $(1 - (\text{number of error code words corrected}) / (\text{number of error code words that can be corrected})) \times 100$
Contrast	CT	Contrast
Focus	FCS	Focus
Overall quality (Standard: DM)	GD0	An overall quality grade for the read code. This is given the lowest weight of the various quality grades.
Decode (Standard: DM)	GD1	A quality grade which shows whether the decode is successful or not.
Contrast	GD2	A quality grade which shows the contrast. This becomes high when the difference between the highest and lowest brightness is large in a code region.
Modulation	GD3	A quality grade which shows the brightness uniformity of cells.
Fixed pattern damage	GD4	A quality grade which shows the damage level of Finder pattern, Timing pattern, and Quiet zone.

Measurement items	Character string	Description
Axis non-uniformity	GD5	A quality grade which shows the ratio of code width and height. This becomes high when a cell shape is close-to-square.
Grid non-uniformity	GD6	A quality grade which shows the deviation of the grid intersections in the data area of the symbol which are compared with positions of the ideal grid in a theoretical perfect symbol.
Unused error correction	GD7	A quality grade which shows the amount of available error correction in a symbol. The fewer the error-corrected words, the higher the grade. results in a higher grade.
Print Growth	GD8	A quality grade which shows the size uniformity of black and white cells. The grade will be Print Growth X or Print Growth Y, whichever is lower.
Print Growth X	GD9	The better the size uniformity of black and white cells toward the X direction, the higher the grade.
Print Growth Y	GD10	The better the size uniformity of black and white cells toward the Y direction, the higher the grade.
Overall quality (Standard: PDF417/Micro-PDF)	GP0	An overall quality grade for the read code. This will be set to the lowest value among all quality grades.
Decode (Standard: PDF417/Micro-PDF)	GP1	A quality grade which shows whether the start pattern, stop pattern, or row indicator were successfully decoded, or not.
RAP symbol contrast	GP2	A quality grade which shows the contrast of the start pattern, stop pattern, or row indicator. The larger the difference between the highest and lowest brightness in a pattern region, the higher the grade.
RAP minimum reflectance	GP3	A quality grade which shows the contrast of the start pattern, stop pattern, or row indicator. Evaluate this with the lowest brightness in pattern region.
RAP minimum edge contrast	GP4	A quality grade which shows the contrast of the start pattern, stop pattern, or row indicator. Evaluate this with the lowest contrast between the bar and space.
RAP modulation	GP5	A quality grade which shows the brightness uniformity of the start pattern, stop pattern, or row indicator. Evaluate this with the ratio between the lowest edge contrast and the symbol contrast.
RAP defect	GP6	A quality grade which shows the brightness uniformity of the start pattern, stop pattern, or row indicator. Evaluate this with the level of the brightness uniformity between the bar and space.
RAP decodability	GP7	A quality grade which shows the printed accuracy of start pattern, stop pattern, or row indicator. The grade becomes high when the width dimension of the bar or space is close to the standard values.
RAP additional	GP8	A quality grade which shows whether or not there is a sufficient Quiet zone width for start pattern, stop pattern, or row indicator.

Measurement items	Character string	Description
RAP overall quality	GP9	An overall quality grade for parts of the start pattern, stop pattern, or row indicator.
Code word yield	GP10	grade quality which shows the efficiency to read the data by scanning a code. Evaluate this with the number of successfully decoded codes to the number of codes decoded when repeatedly scanning codes.
Unused error correction	GP11	A quality grade which shows the amount of available error correction in a symbol. The fewer the error-corrected words, the higher the grade. results in a higher grade.
Decodability	GP12	A quality grade which shows the printed accuracy of codewords. The grade becomes high when the width dimension of the bar or space is close to the standard values.
Defect	GP13	A quality grade which shows the brightness uniformity of the codewords. Evaluate this with the level of the brightness uniformity between the bar and space.
Modulation	GP14	A quality grade which shows the brightness uniformity of the codewords. Evaluate this with the ratio between the lowest edge contrast and the symbol contrast.
Measurement coordinate	X	Code center coordinate X of measurement result
Measurement coordinate	Y	Code center coordinate Y of measurement result
Angle θ	TH	Angle of measurement result
Ref. coordinate	SX	Reference coordinate X of code center
Ref. coordinate	SY	Reference coordinate Y of code center
Ref. angle	ST	Reference angle of code center
Upper left meas. position	MXA	X coordinate of upper left vertex of measurement result
Upper left meas. position	MYA	Y coordinate of upper left vertex of measurement result
Lower left meas. position	MXB	X coordinate of lower left vertex of measurement result
Lower left meas. position	MYB	Y coordinate of lower left vertex of measurement result
Lower right meas. position	MXC	X coordinate of lower right vertex of measurement result
Lower right meas. position	MYC	Y coordinate of lower right vertex of measurement result
Upper right meas. position	MXD	X coordinate of upper right vertex of measurement result
Upper right meas. position	MYD	Y coordinate of upper right vertex of measurement result
Upper left ref. position	SXA	X coordinate of upper left vertex of reference position
Upper left ref. position	SYA	Y coordinate of upper left vertex of reference position
Lower left ref. position	SXB	X coordinate of lower left vertex of reference position
Lower left ref. position	SYB	Y coordinate of lower left vertex of reference position
Lower right ref. position	SXC	X coordinate of lower right vertex of reference position
Lower right ref. position	SYC	Y coordinate of lower right vertex of reference position
Upper right ref. position	SXD	X coordinate of upper right vertex of reference position
Upper right ref. position	SYD	Y coordinate of upper right vertex of reference position

2-30-10 External Reference Tables (2D Code II)

No.	Data name	Data ident	Set/Get	Data range
0	Judge	Judge	Get only	0: No judgment (unmeasured), 1: Judgment result OK, -1: Judgment result NG, -10: Error (image format mismatch), -11: Error (unregistered model), -12: Error (insufficient memory), -20: Error (other errors)
6	Number of decoded characters	decodeCharNum	Get only	-
7	Decoded characters	decodeCharStr	Get only	Character string
8	Index	index	Get only	-
9	Error code	errCode	Get only	0: Normal, -1: Not found 2DCode, -3: Timeout, -7: Too much data to finish
10	Output String	outputCharStr	Get only	Character string
50	Position X	positionX	Get only	-99,999.9999 to 99,999.9999
51	Position Y	positionY	Get only	-99,999.9999 to 99,999.9999
52	Angle	angle	Get only	-180.0000 to 180.0000
53	Reference positionX	referenceX	Get only	-99,999.9999 to 99,999.9999
54	Reference positionY	referenceY	Get only	-99,999.9999 to 99,999.9999
55	Reference angle	referenceAngle	Get only	-180.0000 to 180.0000
70	Upper left reference position X	referenceSXA	Get only	-99,999.9999 to 99,999.9999
71	Upper left reference position Y	referenceSYA	Get only	-99,999.9999 to 99,999.9999
72	Lower left reference position X	referenceSXB	Get only	-99,999.9999 to 99,999.9999
73	Lower left reference position Y	referenceSYB	Get only	-99,999.9999 to 99,999.9999
74	Lower right reference position X	referenceSXC	Get only	-99,999.9999 to 99,999.9999
75	Lower right reference position Y	referenceSYC	Get only	-99,999.9999 to 99,999.9999
76	Upper right reference position X	referenceSXD	Get only	-99,999.9999 to 99,999.9999
77	Upper right reference position Y	referenceSYD	Get only	-99,999.9999 to 99,999.9999
90	Upper left position X	positionMXA	Get only	-99,999 to 99,999
91	Upper left position Y	positionMYA	Get only	-99,999 to 99,999
92	Lower left position X	positionMXB	Get only	-99,999 to 99,999
93	Lower left position Y	positionMYB	Get only	-99,999 to 99,999
94	Lower right position X	positionMXC	Get only	-99,999 to 99,999
95	Lower right position Y	positionMYC	Get only	-99,999 to 99,999
96	Upper right position X	positionMXD	Get only	-99,999 to 99,999

No.	Data name	Data ident	Set/Get	Data range
97	Upper right position Y	positionMYD	Get only	-99,999 to 99,999
103	Reflect to overall judgement	overallJudge	Set/Get	0: ON, 1: OFF
107	Reference X	referencePosX	Set/Get	0 to 99,999.9999
108	Reference Y	referencePosY	Set/Get	0 to 99,999.9999
109	Reference angle	referencePosAngle	Set/Get	-180.0 to 180.0
110	Upper left reference X	referencePosSXA	Set/Get	0 to 99,999.9999
111	Upper left reference Y	referencePosSYA	Set/Get	0 to 99,999.9999
112	Lower left reference X	referencePosSXB	Set/Get	0 to 99,999.9999
113	Lower left reference Y	referencePosSYB	Set/Get	0 to 99,999.9999
114	Lower right reference X	referencePosSXC	Set/Get	0 to 99,999.9999
115	Lower right reference Y	referencePosSYC	Set/Get	0 to 99,999.9999
116	Upper right reference X	referencePosSXD	Set/Get	0 to 99,999.9999
117	Upper right reference Y	referencePosSYD	Set/Get	0 to 99,999.9999
120	Code type	code_type	Set/Get	0: Data Matrix
121	Code color	code_color	Set/Get	0: Auto, 1: Black, 2: White
122	Square size	dm_squSize	Set/Get	0: 10×10, 2: 12×12, to 23: 144×144
123	Rectangle size	dm_recSize	Set/Get	0: 8×18, 2: 8×32, to 5: 16×48
125	DM shape	dm_shape	Set/Get	0: Auto, 1: Square, 2: Rectangle
127	Cell size	cell_size	Get only	0 to 9,999
128	Mirror setting	mirrorimage	Set/Get	0: Auto, 1: Normal, 2: Reverse
131	Timeout	timeout	Set/Get	10 to 99,999
134	Output range	out_rng	Set/Get	0: Not set, 1: Set
135	Output terminator	out_last	Set/Get	1 to 3,200
136	Output starter	out_first	Set/Get	1 to 3,200
138	Character output on NG	errorOut	Set/Get	0: Not output, 1: Output
139	Error output message	errorMessage	Set/Get	Character string
141	Error code output on NG	out_ng	Set/Get	0: Not output, 1: Output
145	Integrated quality	lowerOverallGrade	Set/Get	0 to 4
170	Upper limit for character number	upperCharNum	Set/Get	0 to 3,200
171	Lower limit for character number	lowerCharNum	Set/Get	0 to 3,200
172	Judge compare string	judgeCompString	Set/Get	Character string

No.	Data name	Data ident	Set/Get	Data range
173	Wildcard usage flag for judgement	judgeCompWildcard	Set/Get	0: '*' and '?' are treated as wildcard, 1: '*' and '?' are treated as string
174	Wildcard usage flag for classification	compWildcard	Set/Get	0: '*' and '?' are treated as wildcard, 1: '*' and '?' are treated as string
175	Result display character	resultDisp	Set/Get	0: OFF, 1: ON
176	Display color	dispColor	Set/Get	0: Black, 1: White, 2: Red, 3: Green, 4: Blue
177	Display size	dispSize	Set/Get	10 to 200
181	Flag of output char number	countCharFlag	Set/Get	0: None, 1: 2 bytes, 2: 4 bytes
182	Output code quality	qualityFlag	Set/Get	0: Not output, 1: Output
184	Flag of IO output char	outcharIOFlag	Set/Get	0: OFF, 1: ON
185	Replace GS by any string	replaceGS	Set/Get	0: OFF, 1: ON
186	Replace string	replaceString	Set/Get	Character string
187	Error cell flag	ErrorCellDisp	Set/Get	0: OFF, 1: ON
200	Grade Setting	gradeSetting	Set/Get	0: None, 1: ISO/IEC 15415, 2: ISO/IEC TR29158
231	Setting unit of reference coordinate	refUnitNo	Set/Get	-1 to 9,999
232	Setting type of reference coordinate	refSettingType	Set/Get	0: Numerical, 1: Unit
233	Update the reference angle	updateAngleFlg	Set/Get	0: Not update, 1: Update
236	Use point coordinate before scroll(Central reference setting)	beforeScrollRefMode	Set/Get	0: Not use, 1: Use
237	Position X before scroll	beforeScrollRefPosX	Get only	-99,999.9999 to 99,999.9999
238	Position Y before scroll	beforeScrollRefPosY	Get only	-99,999.9999 to 99,999.9999
239	Angle before scroll	beforeScrollRefAngle	Get only	-180 to 180
240	Upper left position X before scroll	beforeScrollRef-PosSXA	Get only	-99,999.9999 to 99,999.9999
241	Upper left position Y before scroll	beforeScrollRefPos-SYA	Get only	-99,999.9999 to 99,999.9999
242	Lower left position X before scroll	beforeScrollRef-PosSXB	Get only	-99,999.9999 to 99,999.9999
243	Lower left position Y before scroll	beforeScrollRefPos-SYB	Get only	-99,999.9999 to 99,999.9999
244	Lower right position X before scroll	beforeScrollRef-PosSXC	Get only	-99,999.9999 to 99,999.9999
245	Lower right position Y before scroll	beforeScrollRefPos-SYC	Get only	-99,999.9999 to 99,999.9999
246	Upper right position X before scroll	beforeScrollRef-PosSXD	Get only	-99,999.9999 to 99,999.9999

No.	Data name	Data ident	Set/Get	Data range
247	Upper right position Y before scroll	beforeScrollRefPos-SYD	Get only	-99,999.9999 to 99,999.9999
248	Setting unit of Upper left reference coordinate	refAUnitNo	Set/Get	-1 to 9,999
249	Setting unit of Lower left reference coordinate	refBUnitNo	Set/Get	-1 to 9,999
250	Setting unit of Lower right reference coordinate	refCUnitNo	Set/Get	-1 to 9,999
251	Setting unit of Upper right reference coordinate	refDUnitNo	Set/Get	-1 to 9,999
252	Setting type of vertex reference coordinate	VerRefSettingType	Set/Get	0: Numerical, 1: Unit
253	Use point coordinate before scroll(Vertices reference setting)	beforeScrollVerRef-Mode	Set/Get	0: Not use, 1: Use
300+N (N=0 to 35)	Compare string	compString00 to compString35	Set/Get	Character string
10,000	Overall quality(ISO15415)	overallQualityISO15415	Get only	-1.0 to 4.0
10,001	Decode(ISO15415)	decodeISO15415	Get only	-1.0 to 4.0
10,002	Contrast(ISO15415)	contrastISO15415	Get only	-1.0 to 4.0
10,003	Modulation(ISO15415)	modulationISO15415	Get only	-1.0 to 4.0
10,004	Fixed pattern damage(ISO15415)	fixedPatternDamageISO15415	Get only	-1.0 to 4.0
10,005	Axial nonuniformity(ISO15415)	axialNonuniformityISO15415	Get only	-1.0 to 4.0
10,006	Grid nonuniformity(ISO15415)	gridNonuniformityISO15415	Get only	-1.0 to 4.0
10,007	Unused error correction(ISO15415)	unusedErrorISO15415	Get only	-1.0 to 4.0
10,008	Reflectance margin(ISO15415)	reflectanceMarginISO15415	Get only	-1.0 to 4.0
10,009	Print scale(ISO15415)	printScaleISO15415	Get only	-1.0 to 4.0
10,010	Print scaleX(ISO15415)	printScaleXIISO15415	Get only	-1.0 to 4.0
10,011	Print scaleY(ISO15415)	printScaleYIISO15415	Get only	-1.0 to 4.0
10,050	Contrast value(ISO15415)	contrastValueISO15415	Get only	-0.0 to 100.0
10,051	Axial nonuniformity value(ISO15415)	axiNonuniformityValueISO15415	Get only	-0.0 to 100.0
10,052	Grid nonuniformity value(ISO15415)	gridNonuniformityValueISO15415	Get only	-0.0 to 100.0
10,053	Unused error value(ISO15415)	unusedErrorValueISO15415	Get only	-0.0 to 100.0

No.	Data name	Data ident	Set/Get	Data range
10,054	Print scale value(ISO15415)	printScaleValueISO15415	Get only	-1,000.0 to 1,000.0
10,055	Print scaleX value(ISO15415)	printScaleXValueISO15415	Get only	-1,000.0 to 1,000.0
10,056	Print scaleY value(ISO15415)	printScaleYValueISO15415	Get only	-1,000.0 to 1,000.0
10,100	Overall quality(ISO29158)	overallQualityISO29158	Get only	-1.0 to 4.0
10,101	Decode(ISO29158)	decodeISO29158	Get only	-1.0 to 4.0
10,102	Contrast(ISO29158)	contrastISO29158	Get only	-1.0 to 4.0
10,103	Modulation(ISO29158)	modulationISO29158	Get only	-1.0 to 4.0
10,104	Fixed pattern damage(ISO29158)	fixedPatternDamageISO29158	Get only	-1.0 to 4.0
10,105	Axial nonuniformity(ISO29158)	axialNonuniformityISO29158	Get only	-1.0 to 4.0
10,106	Grid nonuniformity(ISO29158)	gridNonuniformityISO29158	Get only	-1.0 to 4.0
10,107	Unused error correction(ISO29158)	unusedErrorISO29158	Get only	-1.0 to 4.0
10,108	Print scale(ISO29158)	printScaleISO29158	Get only	-1.0 to 4.0
10,109	Print scaleX(ISO29158)	printScaleXISO29158	Get only	-1.0 to 4.0
10,110	Print scaleY(ISO29158)	printScaleYISO29158	Get only	-1.0 to 4.0
10,150	Contrast value(ISO29158)	contrastValueISO29158	Get only	-0.0 to 100.0
10,151	Axial nonuniformity value(ISO29158)	axiNonuniformityValueISO29158	Get only	0.0 to 100.0
10,152	Grid nonuniformity value(ISO29158)	gridNonuniformityValueISO29158	Get only	0.0 to 100.0
10,153	Unused error value(ISO29158)	unusedErrorValueISO29158	Get only	0.0 to 100.0
10,154	Print scale value(ISO29158)	printScaleValueISO29158	Get only	-1,000.0 to 1,000.0
10,155	Print scaleX value(ISO29158)	printScaleXValueISO29158	Get only	-1,000.0 to 1,000.0
10,156	Print scaleY value(ISO29158)	printScaleYValueISO29158	Get only	-1,000.0 to 1,000.0
90,000	figure0 Count	figArea0_count	Set/Get	1
90,001	figure0 Type	figArea0_fig0_type	Set/Get	8: Rectangle
90,002	figure0 mode	figArea0_fig0_mode	Set/Get	0: OR
90,014	figure0 Rectangle Upper left position X	figArea0_fig0_box_X0	Set/Get	-99,999 to 99,999
90,015	figure0 Rectangle Upper left position Y	figArea0_fig0_box_Y0	Set/Get	-99,999 to 99,999

No.	Data name	Data ident	Set/Get	Data range
90,016	figure0 Rectangle Lower right position X	figAr- ea0_fig0_box_X1	Set/Get	-99,999 to 99,999
90,017	figure0 Rectangle Lower right position Y	figAr- ea0_fig0_box_Y1	Set/Get	-99,999 to 99,999
90,099	figure0 Update	figArea0_update	Set only	1: Update

2-31 Barcode

Read in barcodes.
Processing can also classify the read-in results.

Used in the Following Case

To read in barcodes and output them to an external device

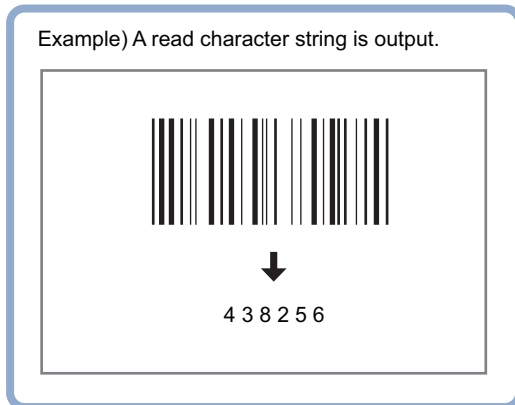

Precautions for Correct Use

Processing is different for color images and monochrome images. When the camera type used in the previous setup was changed to color or monochrome type, perform the settings again.

2-31-1 Settings Flow (Barcode)

To set Barcode, follow the steps below.

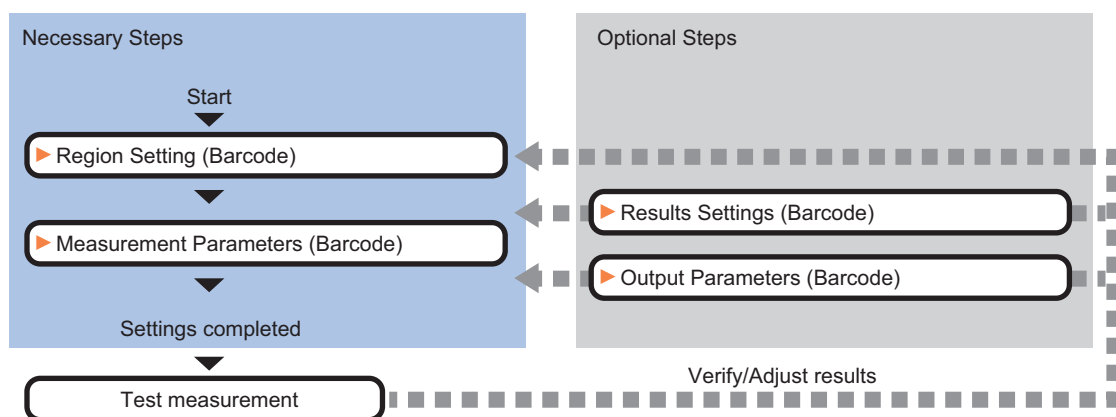

List of Barcode Items

Item	Description
Region setting	Sets the measurement area. It is possible to target the entire screen, but restricting the range can shorten the processing time. <i>2-31-2 Region Setting (Barcode) on page 2-478</i>
Measurement parameter	Sets processing conditions for measurement and judgment conditions for measurement results. Sets a code type, and the number of characters to judge as OK. <i>2-31-3 Measurement Parameters (Barcode) on page 2-478</i>
Result setting	Sets the measurement results. Judgment results can be classified. <i>2-31-4 Results Settings (Barcode) on page 2-482</i>
Output parameter	This item can be changed as necessary. Normally, the factory default value will be used. <i>2-31-5 Output Parameters (Barcode) on page 2-482</i>

2-31-2 Region Setting (Barcode)

Specify the area to search Barcode with a rectangular.
Reducing the measurement range shortens the processing time.



Precautions for Correct Use

- Set the measurement region to 2,448 × 2,044 or less.
- Set the measurement region so that only one barcode is included.
If there is more than one barcode in the measurement region, the measurement may not be performed properly.
- Set the measurement region so that a quiet zone is included.

- 1** In the Item tab area, click **Region setting**.
- 2** Click **Edit**.
The *Figure Setting* area is displayed.
- 3** Specify the area to search Barcode
The rectangle covering the entire screen is set. Adjust the size and position of the rectangle.
- 4** Click **OK** in the *Figure setting* area.
 - **OK**: Changes the settings and returns to the previous menu.
 - **Cancel**: Changes are discarded. Returns to the previous menu.
 - **Apply**: Updates the settings without leaving edit window.

2-31-3 Measurement Parameters (Barcode)

This item sets the judgement conditions for measurement conditions and measurement results. When the Teaching button is clicked, the code type and advanced settings are set automatically. If you then click the Measure button, measurement is executed, the detected barcode region is displayed on the image and the measurement results are displayed as measurement value of the judgement condition.

If measurement cannot be carried out successfully with this procedure, adjust the parameters shown below.

- 1 In the Item Tab area, click **Measurement**.
- 2 In the *Measurement* area, set the *Code Type*.

Setting item	Setting value [Factory default]	Description
Code type	<ul style="list-style-type: none"> • [JAN/EAN/UPC] • Code39 • Codabar • ITF • Code93 • Code 128/ GS1-128 • GS1 DataBar • Pharmacode 	Selects the code type for the code to read. <ul style="list-style-type: none"> • JAN/EAN/UPC: Read JAN/EAN/UPC format barcodes. • Code39: Read Code39 format barcodes. Programmed to read the Full Ascii character set. • Codabar: Read Codabar (NW-7) format barcodes. • ITF: Read ITF (Interleaved 2 of 5) format barcodes. • Code93: Read Code93 format barcodes. • Code 128/GS1-128: Read Code128/GS-128, GS1-128 Composite Code (CC-A, CC-B, CC-C) format barcodes. • GS1 DataBar: Read GS1 DataBar* (Truncated, Stacked, Omni-directional, Stacked Omni-directional, Limited, Expanded, Expanded Stacked), GS1-DataBar Composite Code (CC-A, CC-B) format barcodes. • Pharmacode: Read Pharmacode format barcodes.



Additional Information

The designations for the following code types were standardized to GS1Databar from 2010. In the FH/FHV series, the current designation "GS1Databar" and the old one "RSS" are both indicated.

Select the code type of a new designation corresponding to GS1DataBar.

GS1 DataBar code type new and old comparison table

Code type name	Official name
GS1 DataBar (RSS-14)	GS1 DataBar Omni-directional
GS1 DataBar (RSS Lim.)	GS1 DataBar Limited
GS1 DataBar (RSS Exp.)	GS1 DataBar Expanded

- 3 To set measurement parameters automatically, click **Teaching**.
The following setting items have their detailed settings automatically set.
 - Code Type
 - Composite reflex
 - Auto Magnify level
 - Magnify level

- 4 When making the detailed settings, click **Details** and set each item.

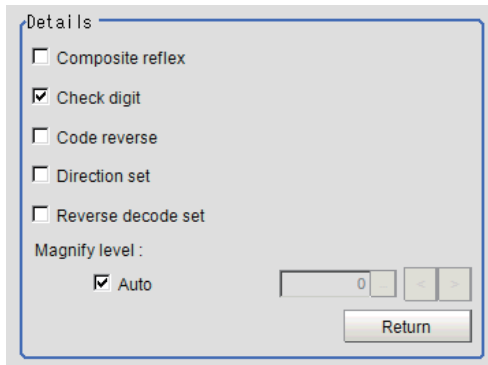

Setting item	Setting value [Factory default]	Description
Composite reflex	<ul style="list-style-type: none"> • Checked • [Unchecked] 	Selects whether or not to read composite code.
Check digit	<ul style="list-style-type: none"> • [Checked] • Unchecked 	Selects whether or not to perform check using the check digit. When check is performed, the check digit is not included in the read character string.
Code reverse	<ul style="list-style-type: none"> • Checked • [Unchecked] 	Selects whether or not to read reversed black or white code.
Direction set	<ul style="list-style-type: none"> • Checked • [Unchecked] 	Selects the direction in which to read barcodes. Unchecked: Reading is performed horizontally. Checked: Reading is performed vertically. This item is valid only when <i>Pharmacode</i> is selected.
Reverse decode set	<ul style="list-style-type: none"> • Checked • [Unchecked] 	Selects whether or not to use reverse mode. This item is valid only when <i>Pharmacode</i> is selected.
Auto magnify level	<ul style="list-style-type: none"> • [Checked] • Unchecked 	Selects whether or not to set the image magnification level automatically when reading code. Checked: The reading is stable. However, the processing time will be longer.
Magnify level	0 to 4 [0]	Sets the image magnification level to be applied when reading code. If reading codes is not well due to a high-resolution camera or image, increase the value. The value is updated when teaching is performed.

- 5 When changing the display settings, set each item in the *Display setting* area.

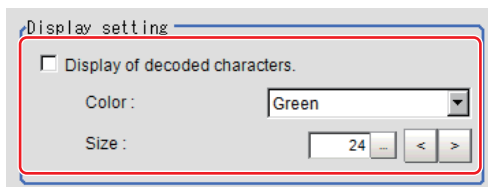

Setting item	Setting value [Factory default]	Description
Display of decoded characters	<ul style="list-style-type: none"> • Checked • [Unchecked] 	Places a check here when displaying the decoded characters.

Setting item	Setting value [Factory default]	Description
Color	<ul style="list-style-type: none"> • Black • White • Red • [Green] • Blue 	Specifies the color for displayed characters.
Size	10 to 200 [24]	Specifies the size of displayed characters.

- 6** If you select *GS1 DataBar* or *GS1-128* for the code type, set a group separator replacement condition.

Setting item	Setting value [Factory default]	Description
Replace the GS (Group Separator) with a specified character string	<ul style="list-style-type: none"> • Checked • [Unchecked] 	Places a check here to replace GS (Group Separator) with another character string when <i>GS1-128</i> or <i>GS DataBar</i> is selected in <i>Code type</i> .
Replacement character string	-	Sets the character string to replace GS with.



Additional Information

Replacing each group separator (control character) with arbitrary character string enables codes containing group separators to be read and compared to a comparison character string.

- 7** When the setting has been changed, click **Measure** in the *Detail* area to verify whether measurements can be made correctly.

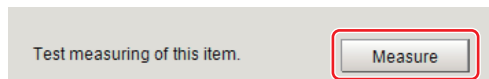

- 8** Set up the judgement condition.

Judgement condition

Character count : 0

Verification string :

'*?*?' is treated as character data.

Integrated quality : 0

Setting item	Setting value	Description
Character count	0 to 1,024 [1,024]	Specifies the character count to be judged as OK.
Verification string	Up to 1,023 characters can be set.	Specifies the comparison string to be judged as OK

Setting item	Setting value	Description
'*' and '?' are used as character data	<ul style="list-style-type: none"> Checked [Unchecked] 	Checked: '*' and '?' are treated as normal characters. Unchecked: '*' and '?' are treated as special characters. '*': Substitution for character string (with zero or more characters).
Integrated quality (lower limit value)	0.0 to 4.0 [0.0]	Specifies the integrated quality to be judged as OK. *1

*1. This can be set when *Code quality display* of *Display setting for print quality* in *Result setting* tab has been checked.

2-31-4 Results Settings (Barcode)

Results can be classified according to the judgement results.

- 1 In the Item tab area, click **Result setting**.
- 2 Register the character string that will be the reference for classification.

Setting item	Setting value [Factory default]	Description
Verification string	-	Specifies the comparison string to be judged as OK Up to 1,023 characters can be set.
'*' and '?' are used as character data	<ul style="list-style-type: none"> Checked [Unchecked] 	Checked: '*' and '?' are treated as normal characters. Unchecked: '*' and '?' are treated as special characters. '*': Substitution for character string (with zero or more characters).

- 3 If necessary, set the quality display for the **Detail Result Pane**.

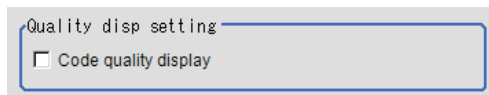

Setting item	Setting value [Factory default]	Description
Code quality display	<ul style="list-style-type: none"> Checked [Unchecked] 	Selects whether or not to display the integrated quality.

2-31-5 Output Parameters (Barcode)

Select how measurement results are output to an external device. This item can be changed if necessary. Normally, the factory default value will be used.

- 1 Click **Output parameter** in the Item Tab area.
- 2 Specify each of the following items.

Setting item	Setting value [Factory default]	Description
Reflect to overall judgment	<ul style="list-style-type: none"> [ON] OFF 	Enables choosing whether or not the judgement results of this processing unit is reflected in the scene overall judgment.
Character output	<ul style="list-style-type: none"> Checked [Unchecked] 	Sets whether or not to output character strings.
Error output	<ul style="list-style-type: none"> Checked [Unchecked] 	Sets whether or not to output errors.
Error output character string	-	Input the character string output when there is an error. Up to 20 characters can be entered.
Output device	<ul style="list-style-type: none"> [RS-232C / RS-422] Ethernet 	When Character output is checked (output), this specifies the device to which strings are output. A character string is output as an ASCII code character string plus a delimiter. The output destination is Serial (RS-232C / 422) or Serial (Ethernet) selected in the Communication of the System Settings . The setting of the IP address of the serial (Ethernet) output destination also follows the System Settings . *1 For details, refer to <i>Non-procedure Communications</i> in the <i>Vision System FH/FHV Series User's Manual for Communications Settings (Cat. No. Z342)</i> .

*1. RS-422 is unavailable in the FH/FHV series.

Output of Character String in PLC Link

In PLC Link communication, if you check the **Character output** in the **Output parameter** tab, the character string and NULL(00 hex)+NULL(00 hex) are output to the data output area of PLC Link.

● Output Format

Take the following case as an example. Number of measurement is one. Reading character string is 32. Command: Read character strings 0123456789...UV, Command, Response, and Data Output area are as follows.

For details, refer to *Communicating with PLC Link, Command Details for PLC Link, EtherNet/IP, and EtherCAT* in *Vision System FH/FHV Series User's Manual for Communications Settings (Cat. No. Z342)*.



Additional Information

If no character string, no data will be output.

- Command (PLC to Sensor Controller)

Command Area		Description
Top Channel +3	Top Channel +2	
0010	1010	Performs one measurement.

- Response (Sensor Controller to PLC)

Response Area		Description
Top Channel	Data	
+2	1010	Command Code: Target command code is responded.
+3	0010	
+4	0000	Response code: Command execution result.
+5	0000	

- Data Output Area (Sensor Controller to PLC)

When read the 32 character strings (0123456789...UV), the result continues as follows. ASCII code data + NULL (00 hex) + NULL (00 hex)

Top channel	Name	Description
+0	1st character, 2nd character	3031 (ASCII code of the character 0, ASCII code of the character 1)
+1	3rd character, 4th character	3233 (ASCII code of the character 2, ASCII code of the character 3)
:	:	:
+15	31st character, 32nd character	5556 (ASCII code of the character U, ASCII code of the character V)
+16	NULL, NULL	NULL (00 hex) + NULL (00 hex)

● How to get the character string

Perform the Data Output Request (DSA) and Data Output Completion (GATE) as in the case of Data Output.

All character string is included in one data. Thereby, Data Output Request (DSA) is performed once if there is one Character Inspection unit.

Output of Character String with Non-procedure Communications

Check the **Character output** in the **Output parameter** tab to output the character string with Non-procedure communication.

● Output Format

Take the following case as an example. Number of measurement is one. Reading character string is 32. Command: Read character strings 0123456789...UV, Command, Response, and Data Output area are as follows.

For details, refer to *Non-procedure Communications* and *MEASURE or M in Non-procedure Command Details* in *Vision System FH/FHV Series User's Manual for Communications Settings* (Cat. No. Z342).

- Command (PLC to Sensor Controller)

M	E	A	S	U	R	E	C _R
---	---	---	---	---	---	---	----------------

 or

M	C _R
---	----------------

- Response (Sensor Controller to PLC)

O	K	C _R
---	---	----------------

0123456789...UV(Character string data) NULL(00 hex)	C _R
---	----------------

Output of Character String with EtherNet/IP Message Communications

In EtherNet/IP message communication, output of character string is possible using UNITDATA command which acquires the measurement value. Outputs the character string data measured and NULL (00 hex).

For details, refer to *Communicating with the Sensor Controller with EtherNet/IP Message Communications, Non-procedure Communications and UNITDATA or UD in Non-procedure Command Details* in *Vision System FH/FHV Series User's Manual for Communications Settings (Cat. No. Z342)*.

● Output Format

Take the following case as an example. Number of measurement is one. Reading character string is 32. Command: Read character strings 0123456789...UV, Command, Response, and Data Output area are as follows. Described example is only a part of Attribute.



Additional Information

- When character strings in multiple lines are output, change the external reference table No. of UNITDATA, and then read the character strings.
- Command (PLC to Sensor Controller)
Specify the command character string equivalent to a non-procedure command.
Attach NULL(00 hex) at the end of the character string. No line feed code is required.
The size of the send data includes the NULL(00 hex) at the end of the character string.

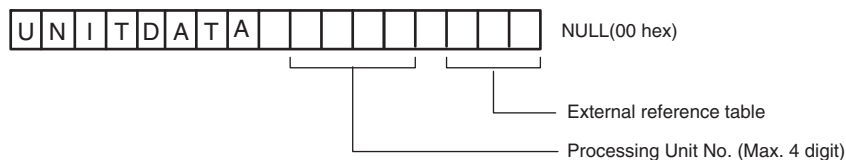

- Response (Sensor Controller to PLC)
Character string data equivalent to the Non-procedure command reception character string is returned.
NULL (00 hex) is inserted in the reception character string delimiter section.
The size of the reception data includes the final NULL(00 hex).

0123456789...UV(Character string data) NULL(00 hex) O(4F hex) K(4B hex) NULL(00 hex)

Output of Character String with Result Output (I/O) with EtherNet/IP

Use the **Result Output (I/O)** processing unit to output the read string.

For details, refer to *Communicating by EtherNet/IP - Setting Output Data (Numerical Values and Character Strings)* in the *Vision System FH/FHV Series User's Manual for Communications Settings (Cat. No. Z342)*.

Output of Character String with Result Output (I/O) with EtherCAT

Use the **Result Output (I/O)** processing unit to output the read string.

For details, refer to *EtherCAT Connections - Setting Output Data (Numerical Values and Character Strings)* in the *Vision System FH/FHV Series User's Manual for Communications Settings (Cat. No. Z342)*.

Output of Character String with Result Output (I/O) with PROFINET

Use the **Result Output (I/O)** processing unit to output the read string.

For details, refer to *Communicating by PROFINET - Setting Output Data (Numerical Values and Character Strings)* in the *Vision System FH/FHV Series User's Manual for Communications Settings (Cat. No. Z342)*.

2-31-6 Key Points for Test Measurement and Adjustment (Barcode)

The following content is displayed in the *Detail result* area as text.

Displayed item	Description
Judge	Judgment results 0: No judgment (unmeasured) 1: Judgment result OK -1: Judgment result NG -10: Error (image format mismatch) -11: Error (unregistered model) -12: Error (insufficient memory) -20: Error (other errors)
Index	Index matched as the result of comparison with the classification comparison character strings
Detected character count	No. of characters detected
Detected character string	Character strings detected Up to 40 characters are displayed (with a new line after every 15th character). From the 41st character on is displayed as "...". Example) Detected character strings: • 123456789012345 • 123456789012345 • 1234567890... (□ indicates a double-byte space.)
Overall quality*1	Result of overall quality

*1. This is displayed only when *Code quality display* check box is selected in the result setting (Barcode).

Key Points for Adjustment (Barcode)

Adjust the setting parameters referring to the following points.

- After teaching has been executed, the read-in character contents are different.

Parameter to be adjusted	Remedy
Measurement parameter	<p>The code type may have been detected incorrectly.</p> <ul style="list-style-type: none"> • Select the code type manually, then measure again. • Set the Narrow bar size and Wide bar size in the Advanced setting to match the displayed barcode image, then execute teaching again. • If the bars are too narrow or there is not much difference in density between the background and the image, correct the image with filtering and execute teaching.

2-31-7 Measurement Results for Which Output Is Possible (Barcode)

The following values can be output using processing items related to result output. It is also possible to reference measurement values from calculation expressions and other processing units.

Measurement items *1	Character string	Description
Judge	JG	<p>Judgment results</p> <p>0: No judgment (unmeasured)</p> <p>1: Judgment result OK</p> <p>-1: Judgment result NG</p> <p>-10: Error (image format mismatch)</p> <p>-11: Error (unregistered model)</p> <p>-12: Error (insufficient memory)</p> <p>-20: Error (other errors)</p>
Number of decoded characters	DN	No. of characters detected
Index	IDX	Index matched as the result of comparison with the classification comparison character strings
Overall quality	GT	This is an overall grade for Composite codes. It will be Overall quality 1D or Overall quality 2D, whichever is lower. If the read code is not a Composite code, the grade will be Overall quality 1D.
Overall quality 1D	GB0	This is an overall grade for a code read. The lowest value among all the Barcode quality grades is set to this.
Decode 1D	GB1	A quality grade which shows whether the decode of the Barcode is successful or not.
Symbol contrast 1D	GB2	A quality grade which shows the contrast of the barcode. The larger the difference between the highest brightness and the lowest, the higher the grade.
Minimum reflection ratio 1D	GB3	A quality grade which shows the contrast of the barcode. Evaluate this with the lowest brightness in the pattern region.
Minimum edge contrast 1D	GB4	A quality grade which shows the contrast of the barcode. Evaluate this with the smallest contrast between bar and space.
Modulation 1D	GB5	A quality grade which shows the brightness uniformity of the barcode. Evaluate this with the ratio between the minimum edge contrast and the symbol contrast.

Measurement items*1	Character string	Description
Defect 1D	GB6	A quality grade which shows the brightness uniformity of the barcode. Evaluate this with the level of the brightness uniformity between the bar and space.
Decodability 1D	GB7	A quality grade which shows the printed accuracy of the barcode. The grade becomes high when the width dimension of the bar or space is close to the standard values.
Additional 1D	GB8	A quality grade which is specific to the code type of barcode.
Overall quality 2D	GP0	An overall quality for 2D Code component of a Composite code. The lowest value among all 2D Code quality grades is set to this.
Decode 2D	GP1	A quality grade which shows whether the start pattern, stop pattern, or row indicator were successfully decoded, or not.
RAP symbol contrast	GP2	A quality grade which shows the contrast of the start pattern, stop pattern, or row indicator. The larger the difference between the highest and lowest brightness in pattern region, the higher the grade.
RAP minimum reflectance	GP3	A quality grade which shows the contrast of the start pattern, stop pattern, or row indicator. Evaluate this with the lowest brightness in pattern region.
RAP minimum edge contrast	GP4	A quality grade which shows the contrast of the start pattern, stop pattern, or row indicator. Evaluate this with the lowest value between bar and space.
RAP modulation	GP5	A quality grade which shows the brightness uniformity of the start pattern, stop pattern, or row indicator. Evaluate this with the ratio between the lowest edge contrast and the symbol contrast.
RAP defect	GP6	A quality grade which shows the brightness uniformity of the start pattern, stop pattern, or row indicator. Evaluate this with the level of the brightness uniformity between the bar and space.
RAP decodability	GP7	A quality grade which shows the printed accuracy of start pattern, stop pattern, or row indicator. The grade becomes high when the width dimension of the bar or space is close to the standard values.
RAP additional	GP8	A quality grade which shows whether or not there is a sufficient Quiet zone width for start pattern, stop pattern, or row indicator.
RAP overall quality	GP9	An overall quality grade for the start pattern, stop pattern, or row indicator.
Code word yield	GP10	A grade quality which shows the efficiency to read the data by scanning a code. Evaluate this with the number of successfully decoded codes to the number of codes decoded when repeatedly scanning codes.

Measurement items*1	Character string	Description
Unused error correction	GP11	A quality grade that shows the amount of available error correction in a symbol. The fewer the error-corrected words, the higher the grade. results in a higher grade.
Decodability 2D	GP12	A quality grade which shows the printed accuracy of codewords. The grade becomes high when the width dimension of the bar or space is close to the standard values.
Defect 2D	GP13	A quality grade which shows the brightness uniformity of the codewords. Evaluate this with the level of the brightness uniformity between the bar and space.
Modulation 2D	GP14	A quality grade which shows the brightness uniformity of the codewords. Evaluate this with the ratio between the minimum edge contrast and the symbol contrast.

*1. "Overall quality 1D" to "Additional 1D" are measurement items of the barcode component of a Composite code. "Overall quality 2D" to "Modulation 2D" are measurement items of the 2D Code component of a Composite code.

2-31-8 External Reference Tables (Barcode)

No.	Data name	Data ident	Set/Get	Data range
0	Judge	judge	Get only	0: No judgment (unmeasured), 1: Judgment result OK, -1: Judgment result NG, -10: Error (image format mismatch), -11: Error (unregistered model), -12: Error (insufficient memory), -20: Error (other errors)
6	Number of decoded characters	decodeCharNum	Get only	-
7	Decoded string	decodeCharStr	Get only	Character string
8	Index	index	Get only	-
9	Overall quality	overallQuality	Get only	0 to 4
10	Overall quality 1D	overallQuality1D	Get only	0 to 4
11	Decode 1D	decode1D	Get only	0 to 4
12	Symbol contrast 1D	symbolContrast	Get only	0 to 4
13	Reflect min 1D	minRefract	Get only	0 to 4
14	Edge contrast 1D	minEdgeContrast	Get only	0 to 4
15	Modulation 1D	modulation1D	Get only	0 to 4
16	Defect 1D	defect1D	Get only	0 to 4
17	Decode ability 1D	decodability1D	Get only	0 to 4
18	Additional 1D	additional1D	Get only	0 to 4
19	Overall quality 2D	overallQualityPDF	Get only	0 to 4
20	Decode 2D	decodePDF	Get only	0 to 4
21	RAP contrast	rapContrast	Get only	0 to 4
22	RAP reflectance	rapReflect	Get only	0 to 4

No.	Data name	Data ident	Set/Get	Data range
23	RAP edge contrast	rapEdgeContrast	Get only	0 to 4
24	RAP modulation	rapModulation	Get only	0 to 4
25	RAP defect	rapDefect	Get only	0 to 4
26	RAP decodability	rapDecodability	Get only	0 to 4
27	RAP additional	rapAdditional	Get only	0 to 4
28	RAP overall quality	rapOverall	Get only	0 to 4
29	Code word yield	codeWordYield	Get only	0 to 4
30	Unused error correction	unusedErrorPDF	Get only	0 to 4
31	Decodability 2D	decodabilityPDF	Get only	0 to 4
32	Defect 2D	defectPDF	Get only	0 to 4
33	Modulation 2D	modulationPDF	Get only	0 to 4
40	Output String	outputCharStr	Get only	Character string
80	GS1 flag	gs1Flag	Get only	0: Normal code, 1: GS1 code
103	Reflect to overall judgement	overallJudge	Set/Get	0: ON, 1: OFF
120	Code type	codeType	Set/Get	0: JAN/EAN/UPC, 1: Code39, 2: Codabar, 3: ITF, 4: Code93, 5: Code128/GS1-128, 6: GS1 DataBar, 7: Pharmacode
121	Wildcard usage flag for judgement	judgeCompWildcard	Set/Get	0: '*' and '?' are treated as wildcard 1: '*' and '?' are treated as string
122	Wildcard usage flag for classification	compWildcard	Set/Get	0: '*' and '?' are treated as wildcard 1: '*' and '?' are treated as string
123	Result display character	resultDisp	Set/Get	0: OFF, 1: ON
124	Display color	dispColor	Set/Get	0: Black, 1: White, 2: Red, 3: Green, 4: Blue
125	Display size	dispSize	Set/Get	10 to 200
136	Check digit	checkDigit	Set/Get	0: OFF, 1: ON
162	Upper limit for character number	upperCharNum	Set/Get	0 to 1,024
163	Lower limit for character number	lowerCharNum	Set/Get	0 to 1,024
164	Judge compare string	judgeCompString	Set/Get	Character string
170	Code reverse	codeColor	Set/Get	0: Not reverse, 1: Reverse
171	Composite reflex	composite	Set/Get	0: Not reflex, 1: Reflex
172	Timeout	timeout	Set/Get	0 to 9,999
173	Direction set	directPharma	Set/Get	0: OFF, 1: ON
174	Reverse decode set	reversePharma	Set/Get	0: OFF, 1: ON
175	Lower limit for overall grade	lowerOverallGrade	Set/Get	0.0 to 4.0
190	Overall quality set	integratedQualityDispSet	Set/Get	0: OFF, 1: ON

No.	Data name	Data ident	Set/Get	Data range
191	Replace Group Separator (GS) by any string	replaceGS	Set/Get	0: OFF, 1: ON
192	Replace string	replaceString	Set/Get	Character string
200	Auto	magnifyAuto	Set/Get	0: OFF, 1: ON
201	Magnify level	magnifyLevel	Set/Get	0 to 4
300+N (N=0 to 35)	Compare string	compString00 to compString35	Set/Get	Character string
400	Flag of character output	outputFlag	Set/Get	0: OFF, 1: ON
401	Output device	outputDevice	Set/Get	0: RS-232C/RS-422 *1 1: Ethernet
402	Error output	errorOut	Set/Get	0: OFF, 1: ON
403	Error string	errorMessage	Set/Get	Character string
90,000	figure0 Count	figArea0_count	Set/Get	1
90,001	figure0 Type	figArea0_fig0_type	Set/Get	8: Rectangle
90,002	figure0 mode	figArea0_fig0_mode	Set/Get	0: OR
90,014	figure0 Rectangle Upper left position X	figAr- ea0_fig0_box_X0	Set/Get	-99,999 to 99,999
90,015	figure0 Rectangle Upper left position Y	figAr- ea0_fig0_box_Y0	Set/Get	-99,999 to 99,999
90,016	figure0 Rectangle Lower right position X	figAr- ea0_fig0_box_X1	Set/Get	-99,999 to 99,999
90,017	figure0 Rectangle Lower right position Y	figAr- ea0_fig0_box_Y1	Set/Get	-99,999 to 99,999
90,099	figure0 Update	figArea0_update	Set only	1: Update

*1. RS-422 is unavailable in the FH/FHV series.

2-32 OCR User Dictionary

Use the OCR user dictionary to store dictionary data to be used in the **OCR** processing unit.
(2-33 *OCR* on page 2-498)

Use this function when you need to recognize special font characters or other characters that cannot be recognized using the built-in dictionary for the **OCR** processing unit.

The dictionary data stored in the **OCR User Dictionary** processing unit can be referenced from multiple instances of the **OCR** processing units.

Used in the Following Case

To create a OCR user dictionary to be used in **OCR** processing unit.

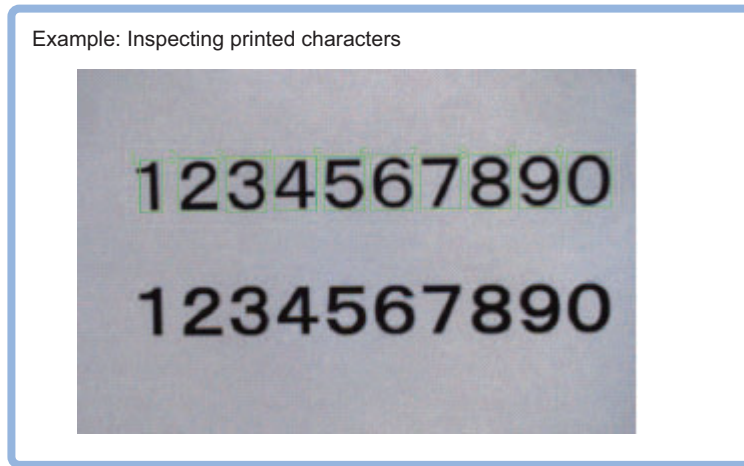

Precautions for Correct Use

- Dictionary data cannot be shared between the OCR user dictionary and the model dictionary.
- The OCR user dictionary can be used for **OCR** processing unit. However, it cannot be used for **Character Inspection** processing unit.
- Processing is different for color images and monochrome images. When the camera type used in the previous setup was changed to color or monochrome type, perform the settings again.

2-32-1 Settings Flow (OCR User Dictionary)

To set OCR User Dictionary, follow the steps below.

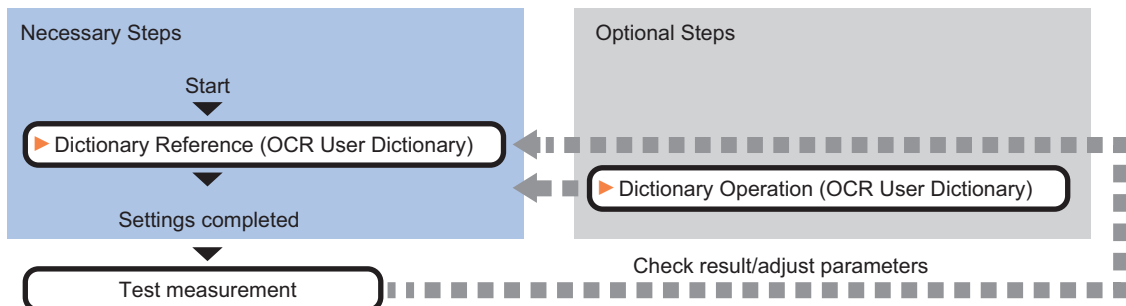

List of OCR User Dictionary Items

Item	Description
Dictionary reference	Configures the dictionary data browsing settings and character data enabling settings used for dictionary reference. <i>2-32-2 Dictionary Reference (OCR User Dictionary) on page 2-493</i>
Dictionary operation	Saves the dictionary data to a file or loads it from the file. <i>2-32-3 Dictionary Operation (OCR User Dictionary) on page 2-496</i>

2-32-2 Dictionary Reference (OCR User Dictionary)

Configure the dictionary data browse settings, character data enable settings used for dictionary reference, and other settings. Dictionary data that can be referenced is data stored using **Dictionary regist** in the **OCR** processing unit.

Refer to *2-33-6 Dictionary Registration (OCR)* on page 2-522.

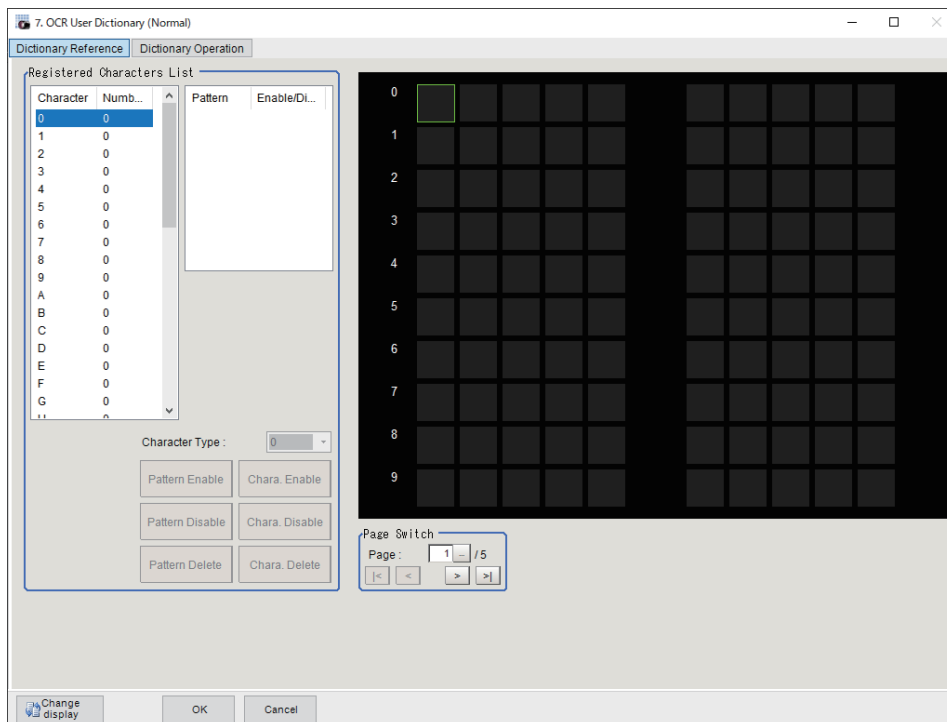

In the *Page Switch* area, switch the character type displayed in the display area.

Setting item	Setting value [Factory default]	Description
Page	1 to 5 [1]	<ul style="list-style-type: none"> 1: Up to 10 patterns from 0 to 9 are displayed for each. 2: Up to 10 patterns from A to J are displayed for each. 3: Up to 10 patterns from K to T are displayed for each. 4: Up to 10 patterns from U to) are displayed for each. 5: Up to 10 patterns of + are displayed for each.



Additional Information

This setting can also be switch by directly clicking the character type in the *Registered Characters List* area.

Setting Pattern Enable/Disable

For each character type, enable the patterns that you want to use for OCR and disable the patterns that you do not want to use.



Additional Information

Up to 10 patterns can be used for each character type.

- 1 In the Item Tab area, click **Dictionary Reference**.
- 2 Select the character type for which one or more patterns are registered from the list in the *Registered Characters List* area.
- 3 Set the **Pattern Enable/Disable**.

Setting item	Setting value [Factory default]	Description
Pattern Enable/ Disable	<ul style="list-style-type: none"> • [ON] • OFF 	Uncheck this item when you do not use a pattern for OCR. When the setting is set to <i>OFF</i> , × is displayed in the upper left of the pattern on the image area. 



Additional Information

This setting can also be set by directly clicking the pattern in the image area.

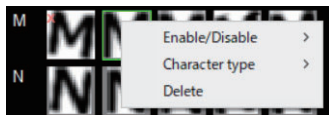

- 4 Click **OK**.
 - **OK**: Changes the settings and returns to the previous menu.
 - **Cancel**: Changes are discarded. Returns to the previous menu.

Changing a Character Type Registered in a Pattern

Change a character type registered in a pattern to different character type.

- 1 Select the character type for which one or more patterns are registered from the list in the *Registered Characters List* area.
- 2 Select the pattern that you want to change from the pattern list.
- 3 Select the character type in **Character Type**.
The character code of the character pattern selected in the list is changed.

Setting item	Setting value [Factory default]	Description
Character Type	0 to 9, A to Z, :/)(+)	Sets the character type.



Additional Information

This setting can also be set by directly clicking the pattern in the image area.

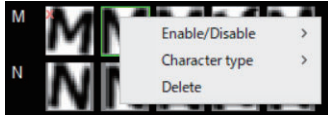

- 4** Click **OK**.
 - **OK**: Changes the settings and returns to the previous menu.
 - **Cancel**: Changes are discarded. Returns to the previous menu.

Setting Character Type Enable/Disable

Enable character types that you want to use for OCR and disable character types that you do not want to use.

- 1** Select the character type for which one or more patterns are registered from the list in the *Registered Characters List* area.
- 2** Click **Chara. Disable**.
All patterns of the character type selected in the list are(is) disabled.
To enable all patterns of the character type selected in the list, click **Chara. Enable**.
To disable only the selected pattern, click the **Pattern Disable**.
To enable only the selected pattern, click the **Pattern Enable**.
- 3** Click **OK**.
 - **OK**: Changes the settings and returns to the previous menu.
 - **Cancel**: Changes are discarded. Returns to the previous menu.

Deleting a Character Type

You can delete a character type that has been registered in the dictionary.

- 1** Select the character type for which one or more patterns are registered from the list in the *Registered Characters List* area.
- 2** Click **Chara. Delete**.
All patterns of the character type selected in the list are(is) deleted.
To delete only the selected pattern, click the **Pattern Delete**.



Additional Information

This setting can also be set by directly clicking the pattern in the image area.

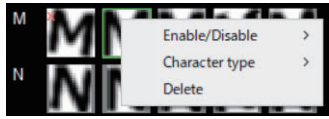

3 Click **OK**.

- **OK**: Changes the settings and returns to the previous menu.
- **Cancel**: Changes are discarded. Returns to the previous menu.

2-32-3 Dictionary Operation (OCR User Dictionary)

Dictionary operations are saving dictionary data to a file and loading dictionary data from a file.

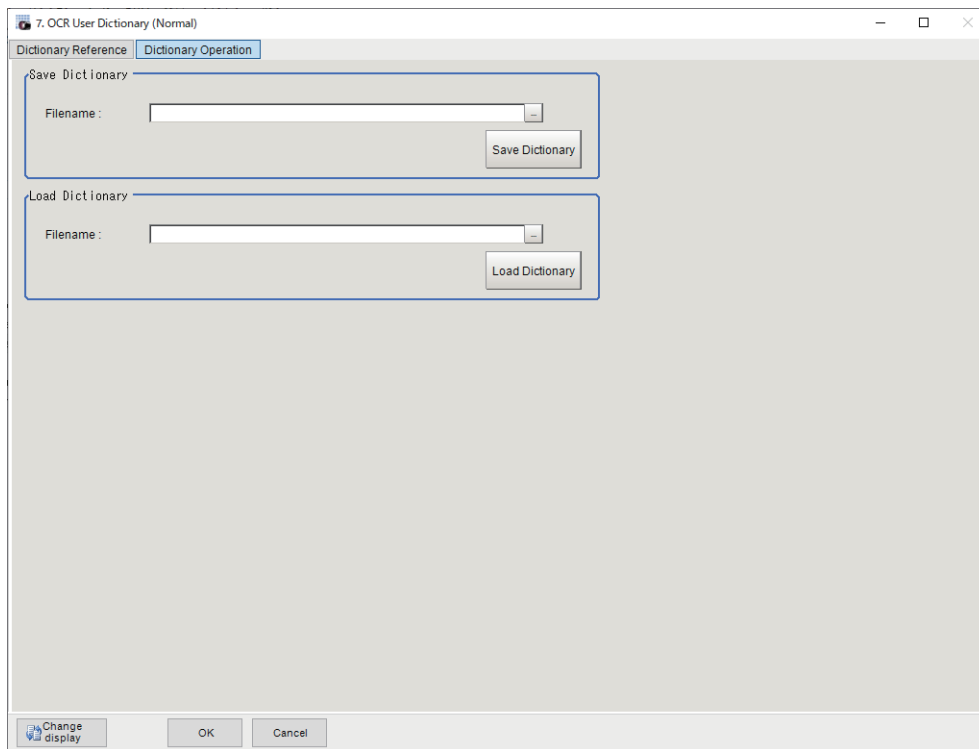

Saving Dictionary Data to a File

The dictionary data of an **OCR User Dictionary** processing unit can be saved to a file.

- 1 In the Item Tab area, click **Dictionary Operation**.
- 2 In the *Save Dictionary* area, specify a value for each item.

Setting item	Setting value [Factory default]	Description
File name	-	Sets the file name used to save the dictionary data of this processing unit.

3 Click **Save Dictionary**.

The dictionary data is saved under the file name in the location specified in **File name**.

Loading Dictionary Data From a File

You can load a dictionary data file and use the data as dictionary data of the OCR user dictionary processing unit.



Additional Information

Dictionary data can be saved and loaded as a file with the extension *cbd*.

1 In the *Load Dictionary* area, specify a value for each item.

Setting item	Setting value [Factory default]	Description
File name	-	Sets the file name used to load the dictionary data of this processing unit.

2 Click **Load Dictionary**.

The dictionary data of the file specified by the file name is loaded.

2-32-4 Key Points for Test Measurement and Adjustment (OCR User Dictionary)

The following content is displayed in the *Detail result* area as text.

Displayed item	Description
Judge	Judgment results 0: No judgment (unmeasured) 1: Judgment result OK -1: Judgment result NG -10: Error (image format mismatch) -11: Error (unregistered model) -12: Error (insufficient memory) -20: Error (other errors)

The image specified in the Sub-image number in the image display setting is displayed in the *Image Display* area.

Sub-image number	Description of image to be displayed
0	Measurement image

2-33 OCR

Characters in images can be recognized and read as text information using the internal font information without the need to prepare dictionary data. Using your own dictionary data (OCR User Dictionary), you can also recognize characters in a special font.

OCR provides a higher level of recognition stability than **Character inspection** processing unit when reading closely spaced characters, curved text strings, and other deviational characters. Setup is easy because there is no need to create a dictionary.

Used in the Following Case

Reading characters printed on a product

Example: Inspection of expiration date, lot number, or other text printed on a curved surface such as a can or bottle.

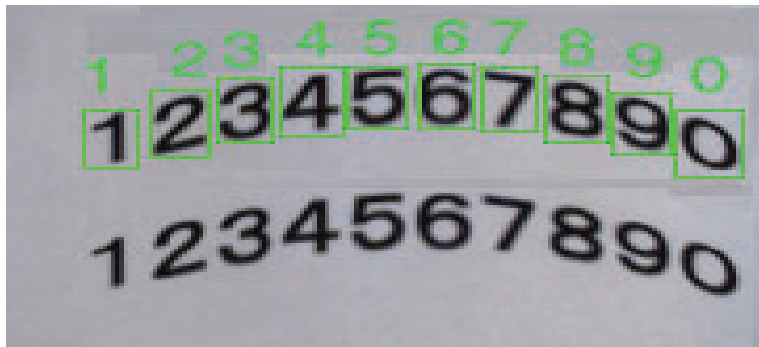

Example: Inspection of manufacturing date, expiration date, or other text printed on a package or label.

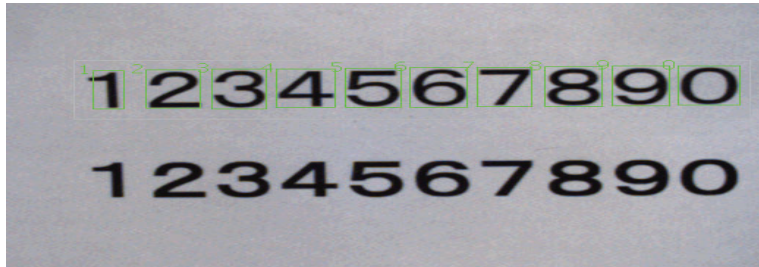



Precautions for Correct Use

The following characters are acceptable for OCR function.

- Letters "A to Z"
- Numbers "0 to 9"
- Period "."
- Colon ":"
- Hyphen "-"
- Apostrophe "'"
- Left parenthesis "("
- Right parenthesis ")"
- Slash "/"
- Plus "+"

Note that measurement cannot be done when the following symbols continue sequentially.

- Period "."
- Colon ":"
- Hyphen "-"
- Apostrophe "'"
- Left parenthesis "("
- Right parenthesis ")"
- Slash "/"

Example:

123./ABC
 |
 | Period and slash are contiguous.

- If the characters overlap or are in contact with each other, the characters cannot be cut out properly. As a result, character recognition cannot be performed well.
- Processing is different for color images and monochrome images. When the camera type used in the previous setup was changed to color or monochrome type, perform the settings again.

2-33-1 Settings Flow (OCR)

To set OCR, follow the steps below.

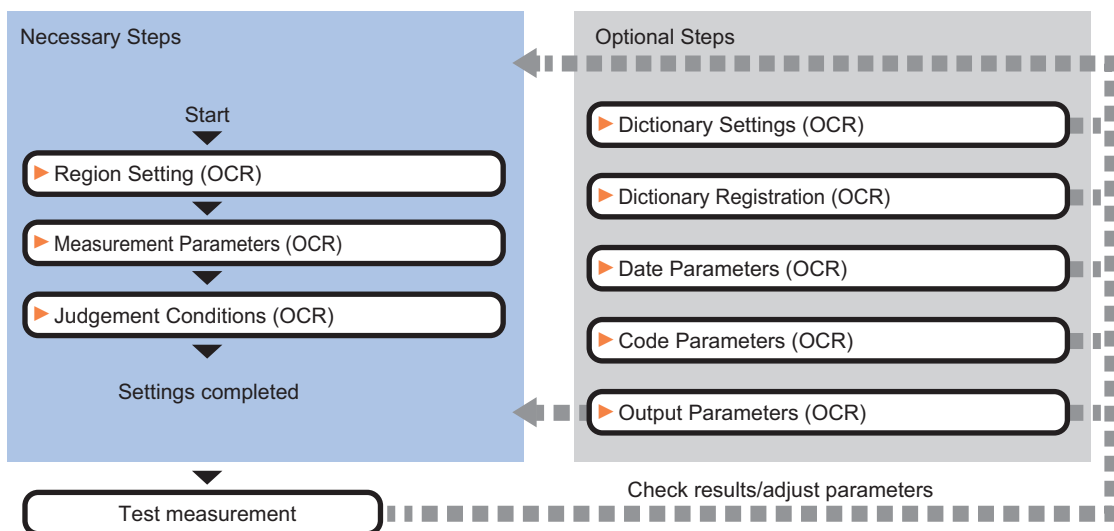

List of OCR Items

Item	Description
Region setting	Sets the measurement area. It is possible to target the entire screen, but restricting the range can shorten the processing time. <i>2-33-2 Region Setting (OCR) on page 2-501</i>
Measurement parameter	Sets the measurement conditions. <i>2-33-3 Measurement Parameters (OCR) on page 2-502</i>
Judgment condition	This item is changed as necessary. Sets processing conditions for measurement and judgment conditions for measurement results. <i>2-33-4 Judgement Conditions (OCR) on page 2-512</i>
Dictionary setting	Sets the dictionary to use for OCR. <i>2-33-5 Dictionary Settings (OCR) on page 2-519</i>
Dictionary regist	Registers characters to OCR user dictionary. <i>2-33-6 Dictionary Registration (OCR) on page 2-522</i>
Date parameter	This item sets the date/time format and update conditions. <i>2-33-7 Date Parameters (OCR) on page 2-523</i>
Code parameter	Set this to print the date encrypted in such a way that it is difficult for the user to recognize. Setting what codes show also makes possible automatic updating.
Output parameter	Sets this to change the output parameters. Set the conditions and parameters to output measurement results to other processing units or external devices as the output parameters. <i>2-33-9 Output Parameters (OCR) on page 2-530</i>

2-33-2 Region Setting (OCR)

For the measurement region, set the region of the image over which you want to detect characters. By narrowing the measurement region (as opposed to measuring the entire input image), this function allows you to shorten the processing time.

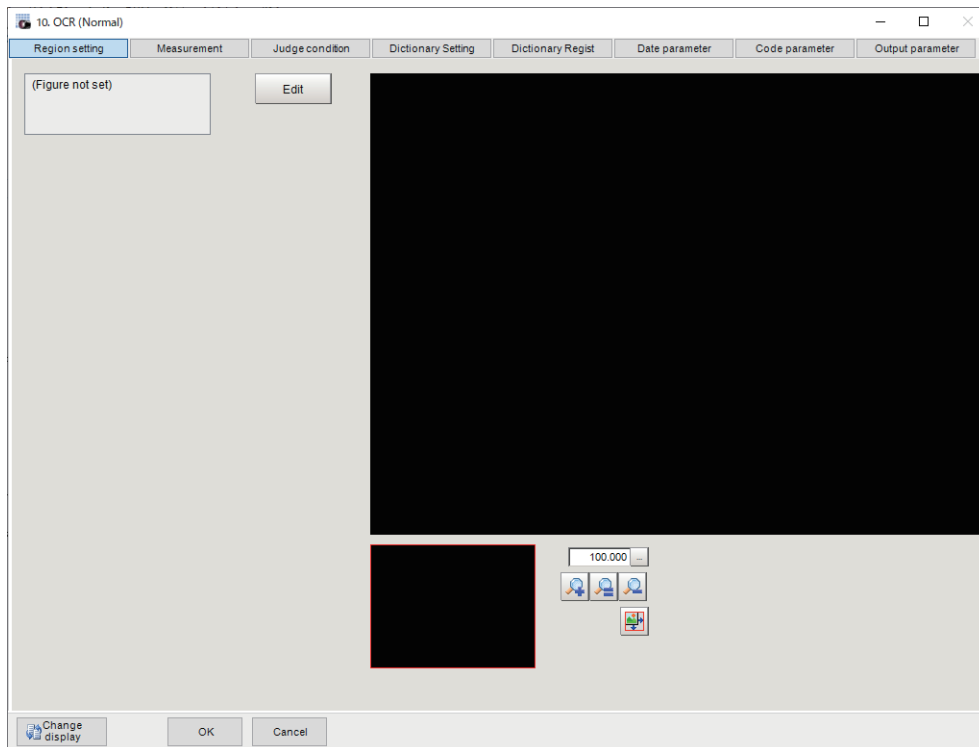

Precautions for Correct Use

- The size of the measurement region should be at least 30 x 30 pixels.
- The measurement region should not include characters that exceed 32 characters by 4 lines.
- The measurement for a measurement region whose height and width are 6,400 pixels or more will be judged as an NG.

- 1** In the Item tab area, click **Region setting**.
- 2** Click **Edit**.
The *Figure Setting* area is displayed.
- 3** Specify the measurement area.
- 4** Click **OK** in the *Figure setting* area.
 - **OK**: Changes the settings and returns to the previous menu.
 - **Cancel**: Changes are discarded. Returns to the previous menu.
 - **Apply**: Updates the settings without leaving edit window.

2-33-3 Measurement Parameters (OCR)

Set the measurement conditions.

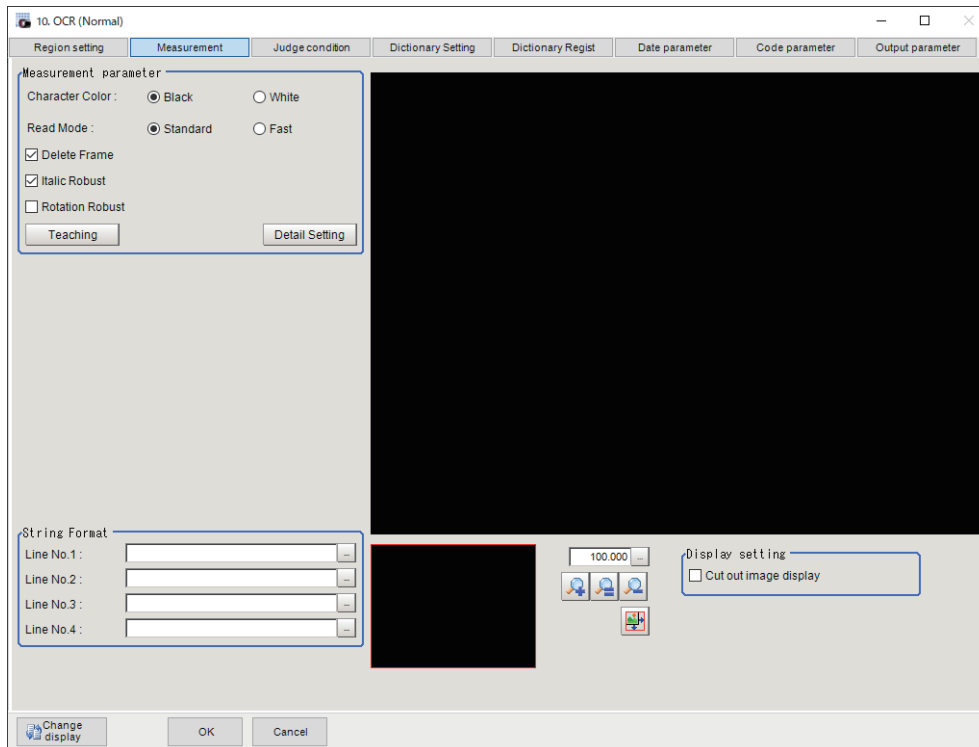



Teaching of Characters to be Recognized

The optimum measurement parameters can be set by teaching characters included in the image.

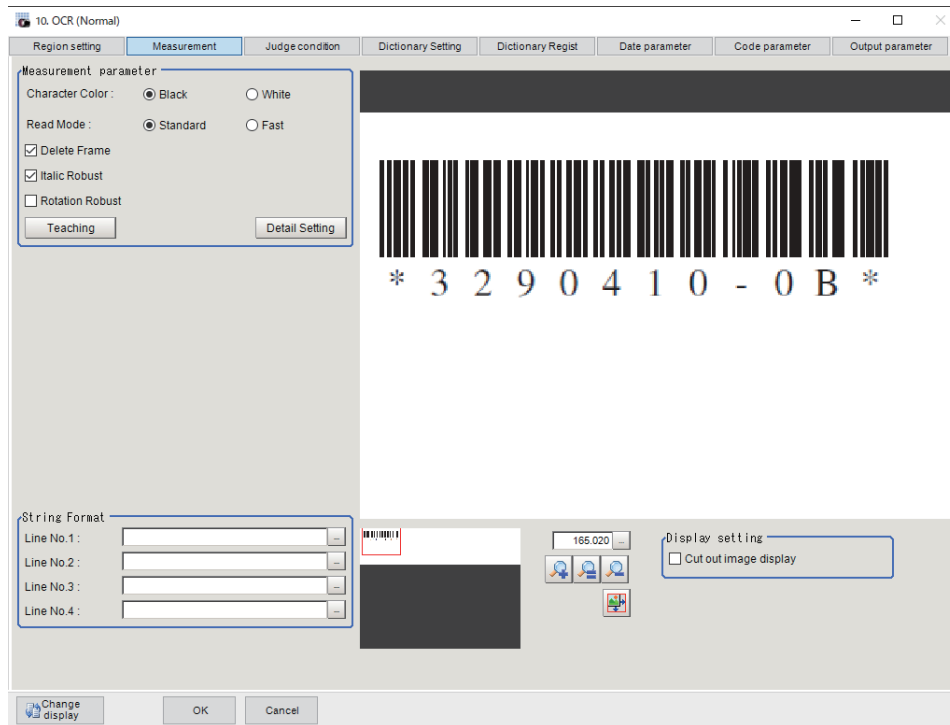
- 1 Click **Measurement** in the Item Tab area.



2 In the *Measurement* area, set the **Character color** and **Read mode**.

Setting item	Setting value [Factory default]	Description
Character color	<ul style="list-style-type: none"> [Black] White 	Sets the color of the characters to be recognized. Set before teaching.
Read mode	<ul style="list-style-type: none"> [Normal] Fast 	Sets read mode used for OCR. <ul style="list-style-type: none"> Normal: A robust reading will be obtained against variety of character conditions such as distorted strings or close characters. Fast: This setting is effective for only finely printed strings which do not contain close or distorted characters. Set before teaching.
Delete Frame	<ul style="list-style-type: none"> [Checked] Unchecked 	To remove black pixels that border the measurement region as noise, check Delete Frame . Example: <ul style="list-style-type: none"> Measurement image  Cut out image (Delete Frame is checked.)  After Teaching, Delete Frame is automatically checked. This may eliminate part of strings if characters are in contact with surrounding patterns. In that case, uncheck the Delete Frame box.

Setting item	Setting value [Factory default]	Description
Italic Robust	<ul style="list-style-type: none"> • [Checked] • Unchecked 	Places a check here when the characters to recognize are Italic or similar. The compensation range is ± 20 degrees. This setting is set automatically when teaching is performed.
Rotation Robust	<ul style="list-style-type: none"> • Checked • [Unchecked] 	Places a check here when the characters to recognize are rotated. The compensation range is ± 15 degrees. This setting is set automatically when teaching is performed.

3 In the *Measurement* area, click **Teaching**.
 The *Teaching* screen appears.

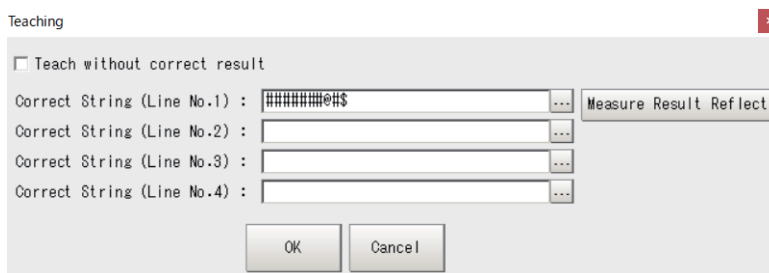

4 In the *Teaching* screen, set a value for each item.

Setting item	Setting value [Factory default]	Description
Teach without correct result	<ul style="list-style-type: none"> • [Checked] • Unchecked 	Places a check here to teach without the correct result. If the recognition is unstable, uncheck this and enter the correct string.
Correct string (Line No.1)	-	Valid only when the check box for not setting the Teach without correct result is unchecked. Set the character string to be the correct result when teaching.*1
Correct string (Line No.2)		
Correct string (Line No.3)		
Correct string (Line No.4)		
Measure result reflect	-	Valid only when the check box for not setting the Teach without correct result is unchecked. When clicked, the current measurement result of this processing item is set in the correct string (Line No.1) to the correct string (Line No.4).

- *1. Example:
- To recognize the text string *2014/01/01*, enter "2014/01/01" in the *String Format* area.
 - To recognize four-digit numbers, enter as #####, where each "#" represents a number, in the string format area.
- Do not include a space in the strings.
 String format settings are disabled when OCV is selected as the Inspection mode.

Label	Description
0 to 9	Normal numeric value input
A to Z	Normal alphabetic character input

Label	Description
' - . : / () +	Normal symbol input
*	Uppercase alphabetic character judgement, Numeric character judgement and Symbol judgement
\$	Uppercase alphabetic character judgement
#	Numeric character judgement
?	Uppercase alphabetic character judgement and numeric character judgement
@	Symbol judgement

5 Click **OK**.

Teaching is executed and the teaching screen closes. The teaching result is applied to the *Measurement* area, and the format of the recognized character string is displayed in the *String format* area.

In the image display area, the recognized characters and the similarity and stability of each character are displayed in green characters.

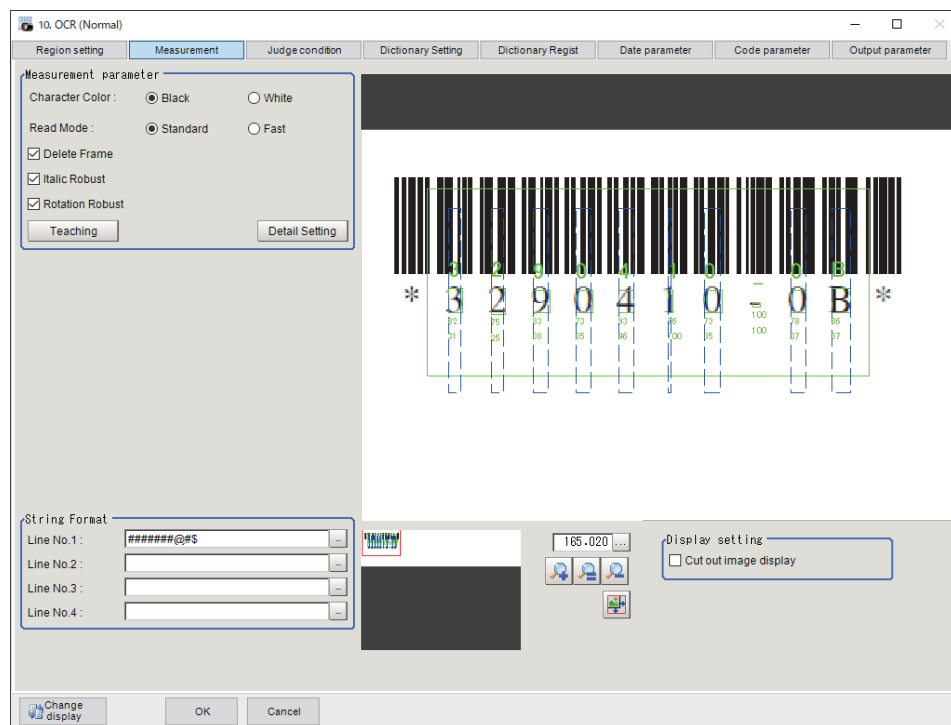

Adjust the measurement parameters as necessary based on the teaching results.



Additional Information

OCR may fail to detect characters or to distinguish confusing characters such as "l" and "1", or "O" and "0" without correct string information. For more specific parameter settings, uncheck the **Teach without correct result** box and input correct strings.



● Setting the Measurement Parameters

Set the conditions for measurement processing and the parameters that are required for measurement.

Adjust the settings based on the teaching result. This setting is not necessary if you want to use the teaching result as it is.

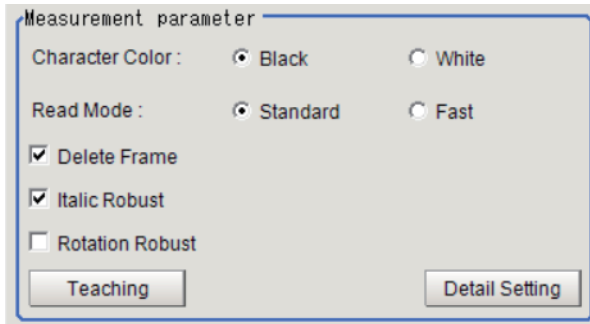
- *Measurement parameter*



Setting item	Setting value [Factory default]	Description
Character color	<ul style="list-style-type: none"> • [Black] • White 	<p>Sets the color of the characters to be recognized. Set before teaching.</p>
Read mode	<ul style="list-style-type: none"> • [Normal] • Fast 	<p>Sets read mode used for OCR.</p> <ul style="list-style-type: none"> • Normal: A robust reading will be obtained against variety of character conditions such as distorted strings or close characters. • Fast: This setting is effective for only finely printed strings which do not contain close or distorted characters. <p>Set before teaching.</p>
Delete Frame	<ul style="list-style-type: none"> • [Checked] • Unchecked 	<p>To remove black pixels that border the measurement region as noise, check Delete Frame. Example:</p> <ul style="list-style-type: none"> • Measurement image  <ul style="list-style-type: none"> • Cut out image (Delete Frame is checked.)  <p>After Teaching, Delete Frame is automatically checked. This may eliminate part of strings if characters are in contact with surrounding patterns. In that case, uncheck the Delete Frame box.</p>
Italic Robust	<ul style="list-style-type: none"> • [Checked] • Unchecked 	<p>Places a check here when the characters to recognize are Italic or similar. The compensation range is ± 20 degrees. This setting is set automatically when teaching is performed.</p>
Rotation Robust	<ul style="list-style-type: none"> • Checked • [Unchecked] 	<p>Places a check here when the characters to recognize are rotated. The compensation range is ± 15 degrees. This setting is set automatically when teaching is performed.</p>

- *Measurement parameter - Detail setting - Detail Para.*

Detail Para.

Font: Common Dot

Thick Threshold:

Dot Pitch X:

Dot Pitch Y:

Max Width Setting

Max Width:



Max Height:

Min Height(%):

Max aspect ratio:

Hyphen Threshold: -

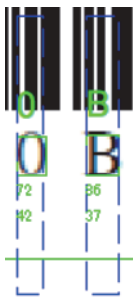
Setting item	Setting value [Factory default]	Description
Font	<ul style="list-style-type: none"> • Common • [dot] 	Sets the font for the characters to be recognized.
Thick threshold	-128 to 128 [0]	<p>Sets the thickness for the characters to be recognized. If the shape for cut-out characters is thin or interrupted, increase the value of Thick threshold.</p> <p>To check the shape of cut-out characters, place a check to Cut out image display in display setting.</p>
Dot pitch X	0 to 99 [0]	<p>Sets the horizontal dot pitch for characters to be recognized. It is particularly effective for connecting dots of dot font to stabilize detection, but it is also useful for fixing breaks of other types of fonts.</p> <p>Note that if the target string contains multiple lines or narrow line spaces, or unnecessary characters are shown in the background, increasing Dot Pitch may merge characters and noise and detection may fail.</p> <p>The unit is pixel.</p> <p>When the font is Common, set the horizontal width for characters to be interrupted.</p> <p>When the font is Dot, set the horizontal pitch for dots.</p> <p>You can confirm the current dot pitch by checking the Cut out image display box. Compensated parts will be shown in gray.</p>

Setting item	Setting value [Factory default]	Description
Dot pitch Y	0 to 99 [0]	<p>Sets the vertical dot pitch for characters to be recognized. It is particularly effective for connecting dots of dot font to stabilize detection, but it is also useful for fixing breaks of other types of fonts.</p> <p>Note that if the target string contains multiple lines or narrow line spaces, or unnecessary characters are shown in the background, increasing Dot Pitch may merge characters and noise and detection may fail.</p> <p>The unit is pixel.</p> <p>When the font is Common, set the vertical width for characters to be interrupted.</p> <p>When the font is <i>Dot</i>, set the vertical pitch for dots.</p> <p>You can confirm the current dot pitch by checking the Cut out image display box. Compensated parts will be shown in gray.</p>
Max width setting	<ul style="list-style-type: none"> • Checked • [Unchecked] 	<p>Check this to manually set the maximum character width for characters to be recognized.</p> <p>If unchecked, the maximum character width will be calculated automatically.</p>
Max width	0 to 9,999 [0]	<p>It is enabled when Max width setting is checked.</p> <p>The character range is cut out with the Max width as the maximum width of one character. Characters are read using the cut out result.</p> <p>If it is recognized as one character including the adjacent character, reduce the value. If one character is divided and recognized, increase the value.</p> <p>The unit is pixel.</p> <p>The Max width is the horizontal line of the blue rectangles displayed on the image in the measurement result.</p> 
Max height	0 to 9,999 [0]	<p>Sets the maximum height for characters to be recognized.</p> <p>The unit is pixel.</p> <p>The Max height is the vertical line of the blue rectangles displayed on the image in the measurement result.</p> 

Setting item	Setting value [Factory default]	Description
Min height [%]	0 to 100 [50]	<p>Sets the height of characters that are only recognized as symbols.</p> <p>Set by the relative value (%) to the height of the character on the left (the character on the right in the case of the left end). Characters with "the height of the adjacent character times Min height [%] times 0.01" or less are recognized only as symbols.</p> <p>Example:</p>  <p>Min height [%]: Default value 50 Character height of A [pixel]: 100 Character height of B [pixel]: 30 Dotted red line: Character height times Min height [%] times 0.01 = 50</p> <ul style="list-style-type: none"> • "B" is recognized only as a symbol because the character height of "B" is smaller than the character height times Min height [%] times 0.01 of the "A" on the left. It is not recognized as the character B. <p>This is valid when the character string is 2 or more characters. In the case of one character, it is measured according to the character string format.</p>
Max aspect ratio	1 to 10 [3]	<p>Sets the maximum aspect ratio (calculated from height and width) for characters to be recognized. Characters with an aspect ratio equal to Max aspect ratio or higher will be recognized as special characters or symbols.</p> <p>Such special characters or symbols are determined with the character string format to be specified.</p> <ul style="list-style-type: none"> • When numeric characters are specified, special characters or symbols are recognized as "1". • When alphabetic characters are specified, they are recognized as "I" or "J". • When symbols are specified, they are recognized as ":", "/", "(" or ")"

Setting item	Setting value [Factory default]	Description
Hyphen threshold	0 to 100 [30] to [70]	Sets the upper and lower limits for the height of a character to be recognized as hyphen " - " by the relative value [%] with respect to neighboring character. Characters that fit within the upper and lower limits of the Hyphen threshold will be recognized as a hyphen. *1 Characters that do not fit within the upper and lower limits of the Hyphen threshold and are below the upper limit of the Hyphen threshold will be recognized as an apostrophe " ' ". Characters that do not fit within the upper and lower limits of the Hyphen threshold and are above the lower limits of the Hyphen threshold will be recognized as a period " . ". Hyphens, periods, and apostrophes are recognized if they are not in continuation, or are in character strings that include other characters.

*1. *Hyphen Threshold value

Hyphen height Upper limit
Default value 30 (%)

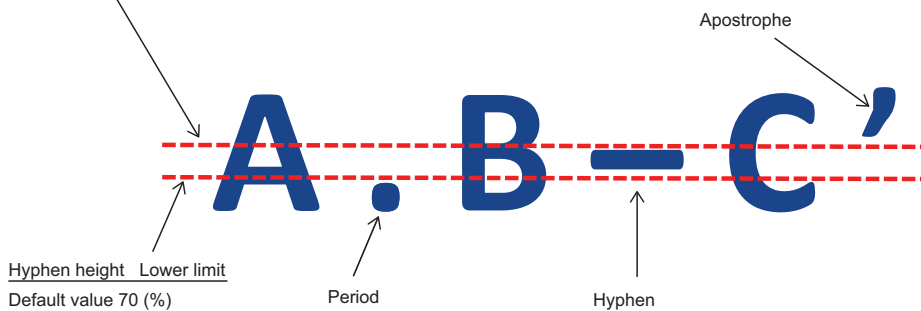

• String Format

String Format

Line No.1:

Line No.2:

Line No.3:

Line No.4:

Setting item	Setting value [Factory default]	Description
String Format (Line No.1)	-	Enter formats of the alphabetical characters or date to be read.*1
String Format (Line No.2)		
String Format (Line No.3)		
String Format (Line No.4)		

*1. Example:

- To recognize the text string 2014/01/01, enter "2014/01/01" in the *String Format* area.
- To recognize four-digit numbers, enter as ####, where each "#" represents a number, in the string format area.

Do not include a space in the strings.

String format settings are disabled when OCV is selected as the Inspection mode.

Label	Description
0 to 9	Normal numeric value input
A to Z	Normal alphabetic character input
' - . : / () +	Normal symbol input
*	Uppercase alphabetic character judgement, Numeric character judgement and Symbol judgement
\$	Uppercase alphabetic character judgement
#	Numeric character judgement
?	Uppercase alphabetic character judgement and numeric character judgement
@	Symbol judgement

● Checking Measurement Results in the Image (Display Setting)

You can change the display settings to check the processing conditions for measurements on the image.

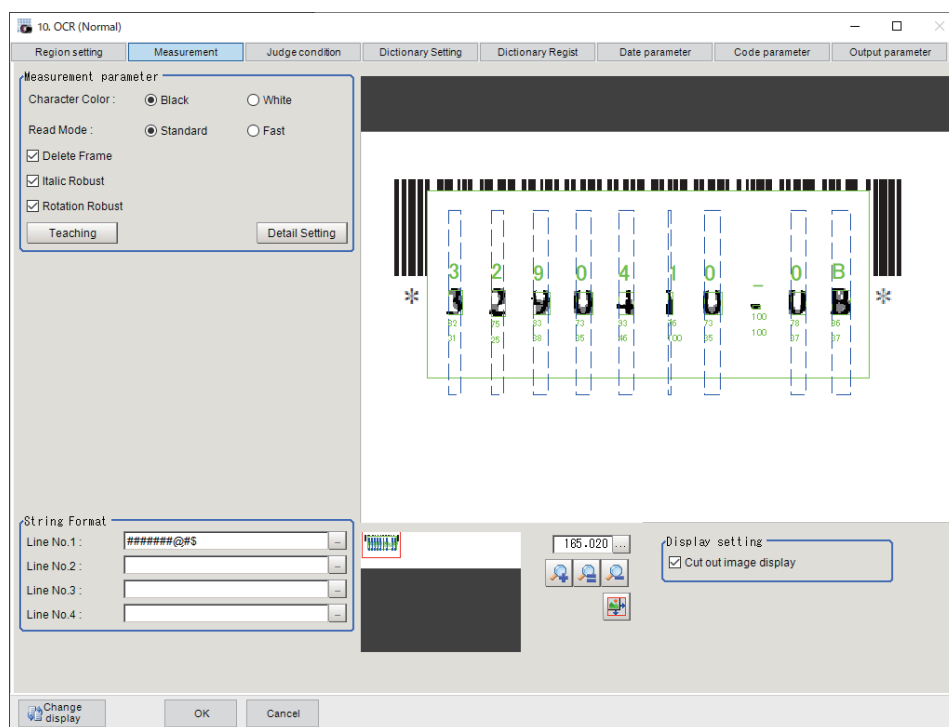

- 1 In the *Display Setting* area, set a value for each item.

Setting item	Setting value [Factory default]	Description
Cut out image display	<ul style="list-style-type: none"> • Checked • [Unchecked] 	<p>Places a check here to check the shape for cut-out characters.</p> <p>The gray region displayed in the cut-out image display is the region put together with the <i>Dot pitch Y</i> and <i>Dot pitch X</i> parameters.</p> <p>Example:</p> 

- 2 Check the conditions of measurement processing on the image and set the measurement parameters.

2-33-4 Judgement Conditions (OCR)

Set the conditions for judging the measurement results.

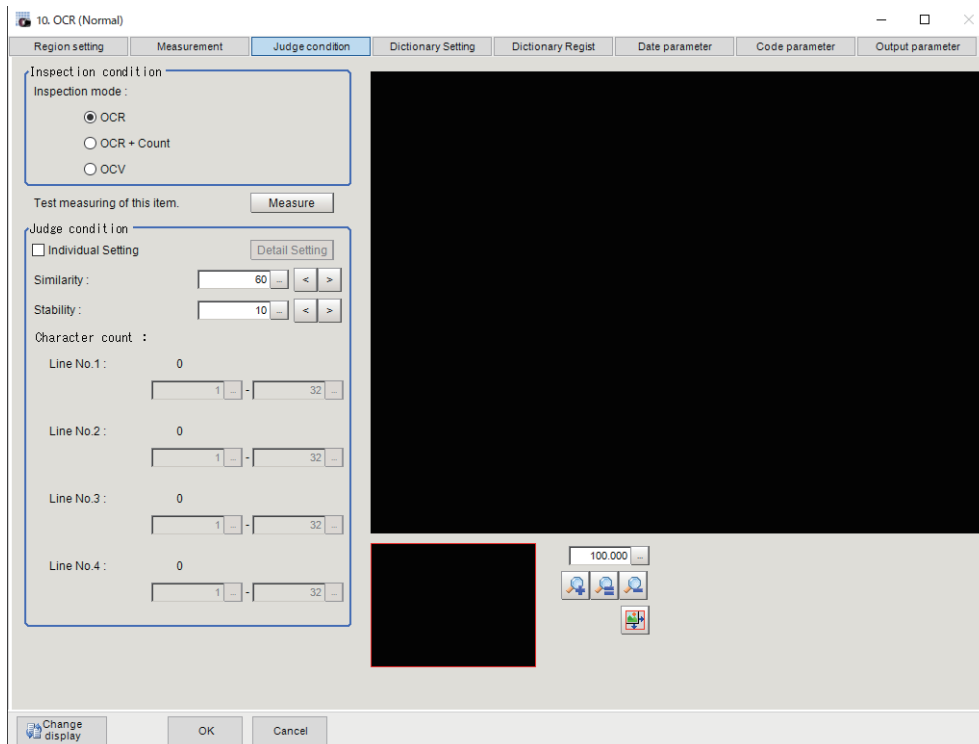

- 1 In the Item Tab area, click **Judge condition**.
- 2 In the *Inspection Condition* area, set a value for each item.

Setting item	Setting value [Factory default]	Description
Inspection mode	<ul style="list-style-type: none"> [OCR] OCR + Count OCV 	<p>Specifies the inspection mode.</p> <ul style="list-style-type: none"> OCR: Judge by Similarity and Stability. (<i>Setting the Judgment Conditions for Similarity and Stability</i> on page 2-514) OCR + Count: Judge by Similarity, Stability and Character count per row.*¹ (<i>Setting the Judgment Conditions for Similarity and Stability</i> on page 2-514, <i>Setting the Judgment Conditions for Character Count per Row</i> on page 2-517) OCV: Judge by Similarity, Stability and Verification string matching result. (<i>Setting the Judgment Conditions for Similarity and Stability</i> on page 2-514, <i>Setting the Judgment Conditions for Verification String Matching Result</i> on page 2-517)

*1. The Count inspection does not check the presence of character strings.
 For instance, when you set the number of characters for Line 1 to Line 4 as judgment condition and the system inspects a measurement object having three lines of character strings, the inspection is performed as three lines. Although the fourth line has no characters, it will not be judged as NG.

• Inspection mode - OCR

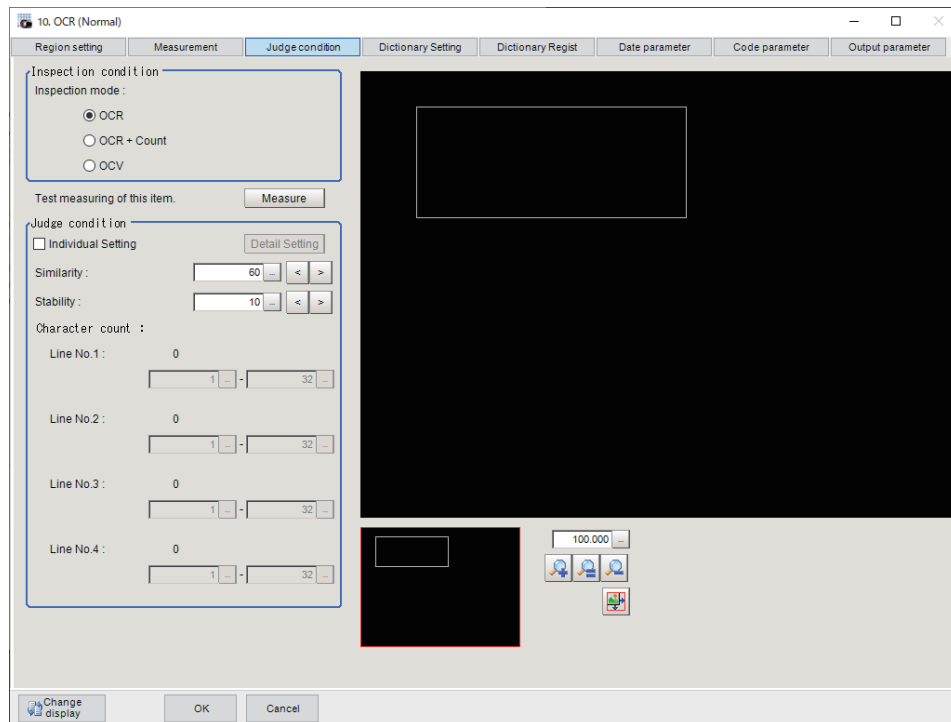

• Inspection mode - OCR + Count

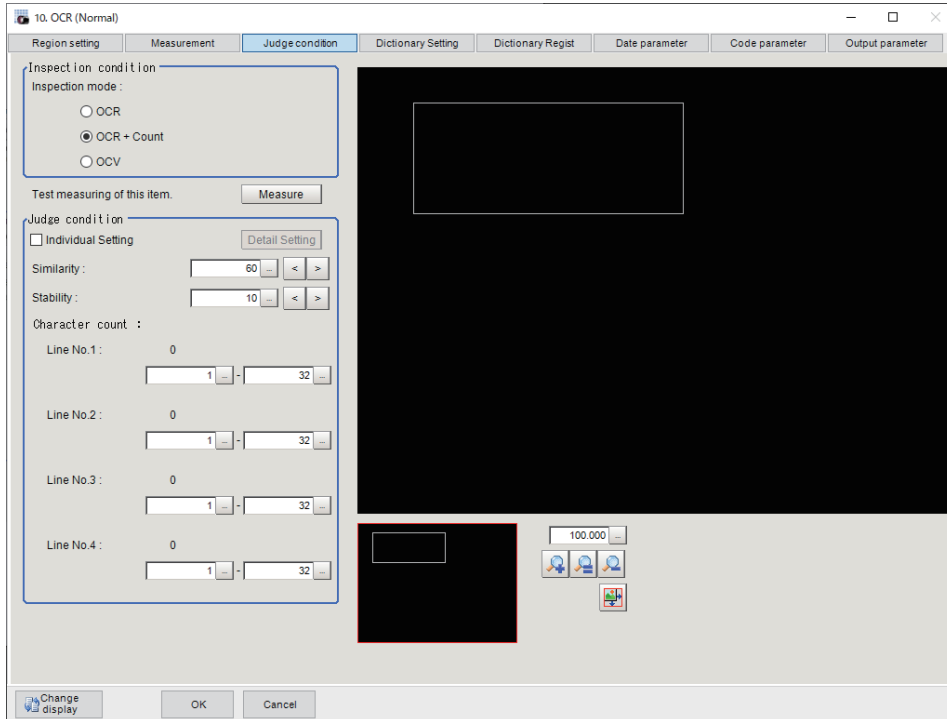

- Inspection mode - OCV

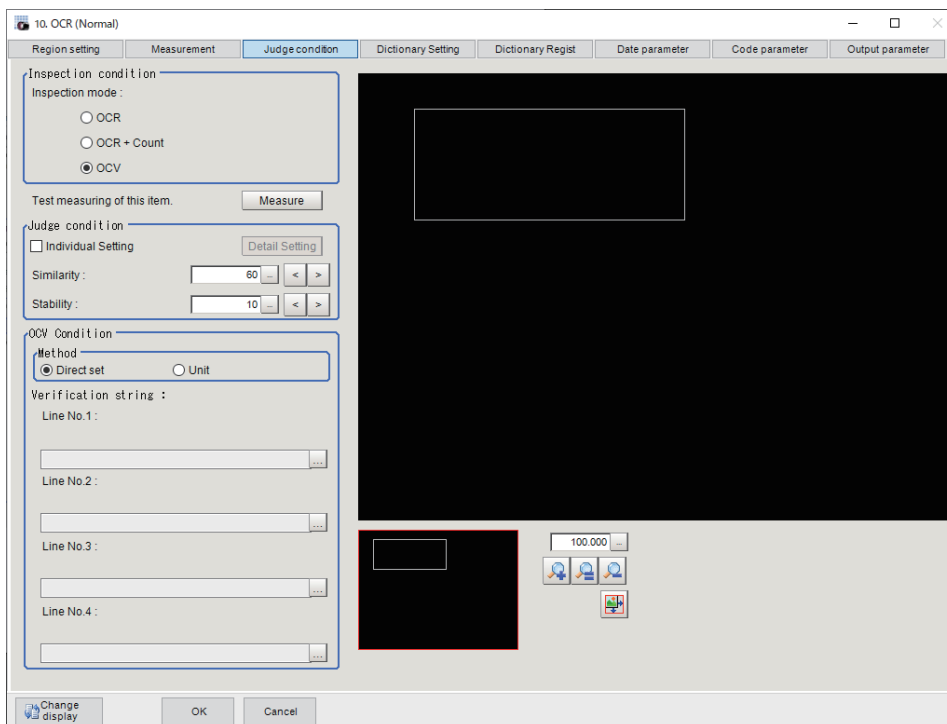

Setting the Judgment Conditions for Similarity and Stability

Set the similarity and stability judgment conditions for all characters at once. If you want to set the similarity and stability judgement conditions separately, refer to *Setting Judgement Conditions Individually by Character* on page 2-515.

- 1** In the *Judge Condition* area, set a value for each item.

Setting item	Setting value [Factory default]	Description
Individual setting	<ul style="list-style-type: none"> • Checked • [Unchecked] 	<p>When you want to individually set the judgment conditions for each character for the similarity and stability, place a check here, Individual setting.</p> <p>When the Individual setting is checked, the Detail setting is enabled.</p>
Similarity	0 to 100 [60]	<p>Sets the lower limit value for the similarity.</p> <p>The similarity indicates the degree of how a read character string is similar to the font information of the correct character string. The more the font information for the read character string is similar to that for the correct character string, the higher the similarity.</p>
Stability	0 to 100 [10]	<p>Sets the lower limit value for stability. The stability is expressed by subtracted the similarity of the second candidate for the read character from the similarity of the first candidate for the read character.</p> <p>When the degree of the similarity between the candidates is low, the possibility for the reading error becomes higher. If the second candidate cannot be detected, the stability is always output as 100 regardless of the similarity for the first candidate.</p> <p>The result will be OK when the stability is higher than the Stability.</p>

● Setting Judgement Conditions Individually by Character

Set judgement conditions for all characters individually by character.

- 1** Check the **Individual setting** in the *Judge Condition* area. Click *Detail setting*. The *Individual Judgement Condition* area appears.

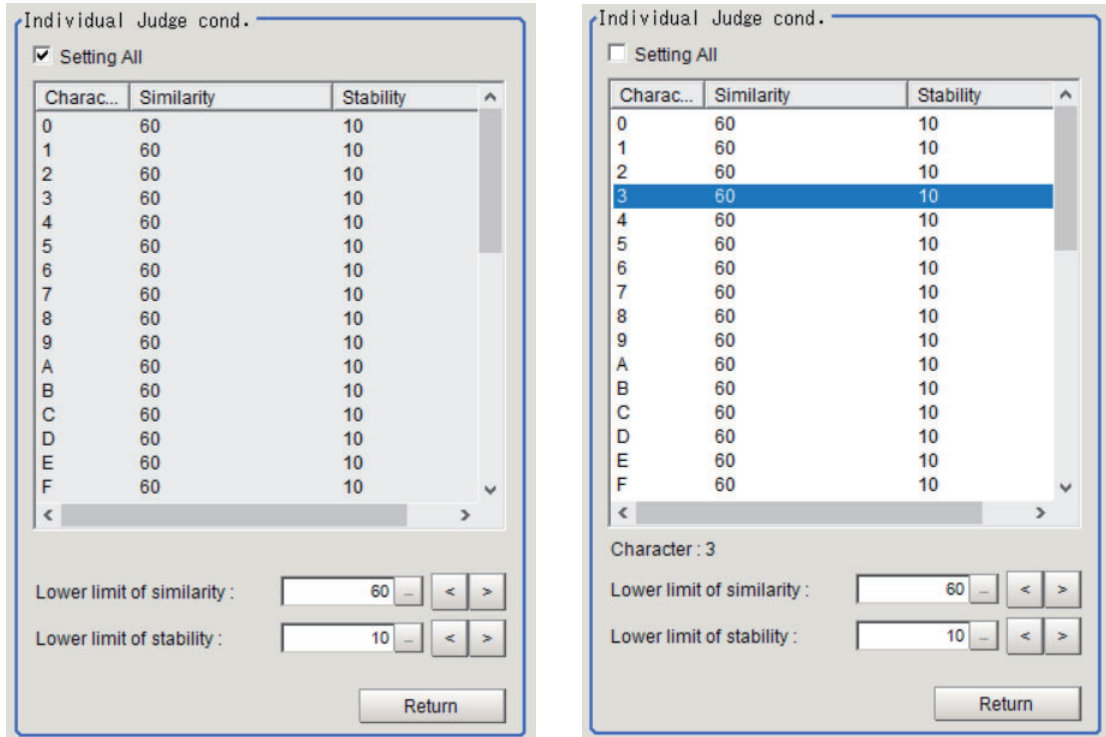

2 Set the items in the *Individual Judge cond.* area.

Setting item	Setting value [Factory default]	Description
Batch setting	<ul style="list-style-type: none"> [Checked] Unchecked 	If you want to set the similarity and stability judgment conditions at once for all characters, place a check in the Batch setting . If unchecked, the similarity and stability judgment conditions can be set for each character.
Lower limit of similarity	0 to 100 [60]	Sets a lower limit value for the similarity.
Lower limit of stability	0 to 100 [10]	Sets a lower limit value for the stability.



Additional Information

Each time a measurement is performed, the recognized characters and the similarity and stability of each character are displayed in green characters in the image display area. Judgement conditions can be set with reference to these values.

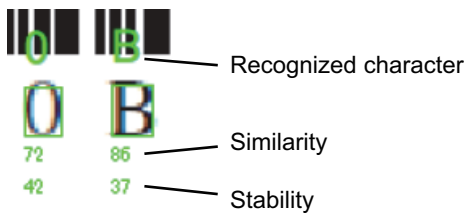

Setting the Judgment Conditions for Character Count per Row

The setting is valid only when *OCR + Count* is selected in the **Inspection mode**.

- 1 In the *Judge Condition* area, set a value for each item.

Setting item	Setting value [Factory default]	Description
Character count (Line No. 1)	1 to 32 [1] to [32]	Sets the judgment condition for the number of characters on the first line.
Character count (Line No. 2)	1 to 32 [1] to [32]	Sets the judgment condition for the number of characters on the second line.
Character count (Line No. 3)	1 to 32 [1] to [32]	Sets the judgment condition for the number of characters on the third line.
Character count (Line No. 4)	1 to 32 [1] to [32]	Sets the judgment condition for the number of characters on the fourth line.

Setting the Judgment Conditions for Verification String Matching Result

This setting is valid only when *OCV* is selected in the **Inspection mode**.

- 1 In the *OCV Condition* area, set a value for each item.

Setting item	Setting value [Factory default]	Description
OCV condition	<ul style="list-style-type: none"> • [Direct set] • Unit 	Selects how to specify the verification character string. When measurement results of other processing units in the measurement flow is specified as the verification character string, select <i>Unit</i> instead.
Verification string (Line No.1)	-	This setting is valid only when <i>Direct set</i> is set in the OCV condition . Set the character string to verify on the first line. *1
Verification string (Line No.2)	-	This setting is valid only when <i>Direct set</i> is set in the OCV condition . Set the character string to verify on the second line. *1
Verification string (Line No.3)	-	This setting is valid only when <i>Direct set</i> is set in the OCV condition . Set the character string to verify on the third line. *1
Verification string (Line No.4)	-	This setting is valid only when <i>Direct set</i> is set in the OCV condition . Set the character string to verify on the fourth line. *1

Setting item	Setting value [Factory default]	Description
Unit	Processing unit in the measurement flow [<None>]	This setting is valid only when <i>Units</i> set in the OCV condition . Selects the processing unit with the measurement results to be used as the verification character string. The processing items that can be selected as the reference unit are as follows. <ul style="list-style-type: none"> • 2D Code II • 2D Code • Barcode
Verification limits 1	<ul style="list-style-type: none"> • Checked • [Unchecked] 	This setting is valid only when <i>Units</i> set in the OCV condition . Place a check here Verification limits 1 to verify the character string on the first line.
	1 to 3200 [1] to [3200]	This setting is valid only when a check is placed in the Verification limits 1 . Set the range for the character string that is used for the verification character string on the first line for the measurement results of the processing unit specified in the reference unit.
Verification limits 2	<ul style="list-style-type: none"> • Checked • [Unchecked] 	This setting is valid only when <i>Units</i> set in the OCV condition . Place a check here Verification limits 2 to verify the character string on the second line.
	1 to 3,200 [1] to [3,200]	This setting is valid only when a check is placed in the Verification limits 2 . Set the range for the character string that is used for the verification character string on the second line for the measurement results of the processing unit specified in the reference unit.
Verification limits 3	<ul style="list-style-type: none"> • Checked • [Unchecked] 	This setting is valid only when <i>Units</i> set in the OCV condition . Place a check here Verification limits 3 to verify the character string on the third line.
	1 to 3,200 [1] to [3,200]	This setting is valid only when a check is placed in the Verification limits 3 . Set the range for the character string that is used for the verification character string on the third line for the measurement results of the processing unit specified in the reference unit.
Verification limits 4	<ul style="list-style-type: none"> • Checked • [Unchecked] 	This setting is valid only when <i>Units</i> set in the OCV condition . Place a check here Verification limits 4 to verify the character string on the fourth line.
	1 to 3,200 [1] to [3,200]	This setting is valid only when a check is placed in the Verification limits 4 . Set the range for the character string that is used for the verification character string on the fourth line for the measurement results of the processing unit specified in the reference unit.

*1. The characters that can be used for verification character string are shown in the table.

Do not include a space in the strings.

(Examples for acceptable formats)

To make a character string consisting of three uppercase alphabet letters, four digits of a current year, and two digits of a current month to recognize, enter "\$\$\$-####/##" in the string format area.

Label	Description
0 to 9	Normal numeric value input
A to Z	Normal alphabet input
' - . : / () +	Normal mark input
*	Character presence judgement
\$	Number judgement
mYY	The last two digits of the current year
mYYYY	Four digits of the current year
mHH	Two digits of the current year in the Japanese era calendar *1
mMM	Current month
mDD	Current day
mRR	Current hour
mNN	Current minute
vYY	The last two digits of the year of usage period set on the Date parameter tab
vYYYY	Four digits of the year of usage period set on the Date parameter tab
vHH	Two digits of the year of usage period set on the Date parameter tab in the Japanese era calendar *1
vMM	Month of usage period set on the Date parameter tab
vDD	Day of usage period set on the Date parameter tab
eY1	"Year 1" encrypted on the Code parameter tab
eM1	"Month 1" encrypted on the Code parameter tab
eD1	"Day 1" encrypted on the Code parameter tab
eR1	"Hour 1" encrypted on the Code parameter tab
eN1	"Minute 1" encrypted on the Code parameter tab
eY2	"Year 2" encrypted on the Code parameter tab
eM2	"Month 2" encrypted on the Code parameter tab
eD2	"Day 2" encrypted on the Code parameter tab
eR2	"Hour 2" encrypted on the Code parameter tab
eN2	"Minute 2" encrypted on the Code parameter tab
iY1	"Year 1" encrypted on the Code parameter tab for the usage period set on the Date parameter tab
iM1	"Month 1" encrypted on the Code parameter tab for the usage period set on the Date parameter tab
iD1	"Day 1" encrypted on the Code parameter tab for the usage period set on the Date parameter tab
iY2	"Year 2" encrypted on the Code parameter tab for the usage period set on the Date parameter tab
iM2	"Month 2" encrypted on the Code parameter tab for the usage period set on the Date parameter tab
iD2	"Day 2" encrypted on the Code parameter tab for the usage period set on the Date parameter tab

*1. The value referred to as an era name is determined by *the first year of era name* in the *Date setting* area.

2-33-5 Dictionary Settings (OCR)

Use this item to change the dictionary settings.
Set the dictionary to be used for OCR.

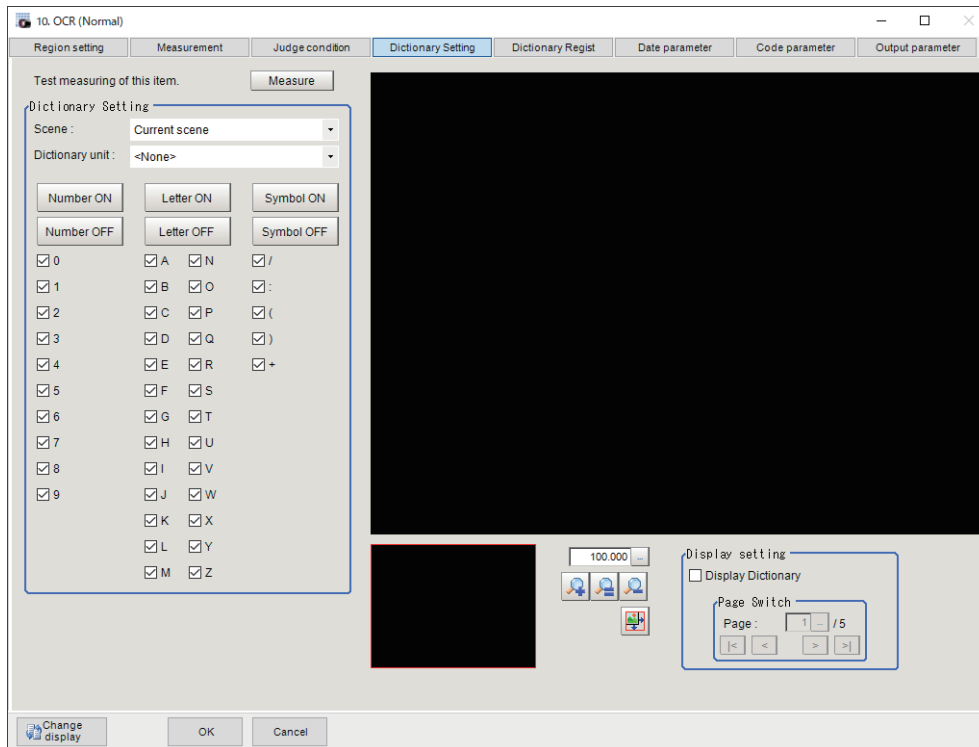

Selecting the Character Type Used for OCR

Individually set each character type that is used and each character type that is not used in the dictionary used for OCR.

- 1 In the Item Tab area, click **Dictionary Setting**.
- 2 In the *Dictionary setting* area, set a value for each item.

Setting item	Setting value [Factory default]	Description
Scene	-1 to 127 [-1: Current scene]	Sets the scene number in which the OCR user dictionary processing unit to be used in OCR processing unit is registered.
Dictionary unit	-1 to 9,999 [-1: <None>]	Sets the processing unit number for the OCR user dictionary processing unit to be used in OCR processing unit.
Character type specification 0 to 9, A to Z, /, :, (,), +	<ul style="list-style-type: none"> • [Checked] • Unchecked 	Places a check for the character type to be used in OCR processing unit. When it is unchecked, the characters specified in the OCR user dictionary processing unit are also unavailable.

- 3 Click **Measure**.

A test measurement of the measurement image is executed using the current settings, and the measurement results appear on the image. Check if the measurement is correct.

2-33-6 Dictionary Registration (OCR)

Use this item to perform dictionary registration.

Dictionary registration consists of registering characters in a **OCR user dictionary** processing unit set on the **Dictionary Setting** tab.

Set when you want to measure characters in a special font or when characters are incorrectly recognized.

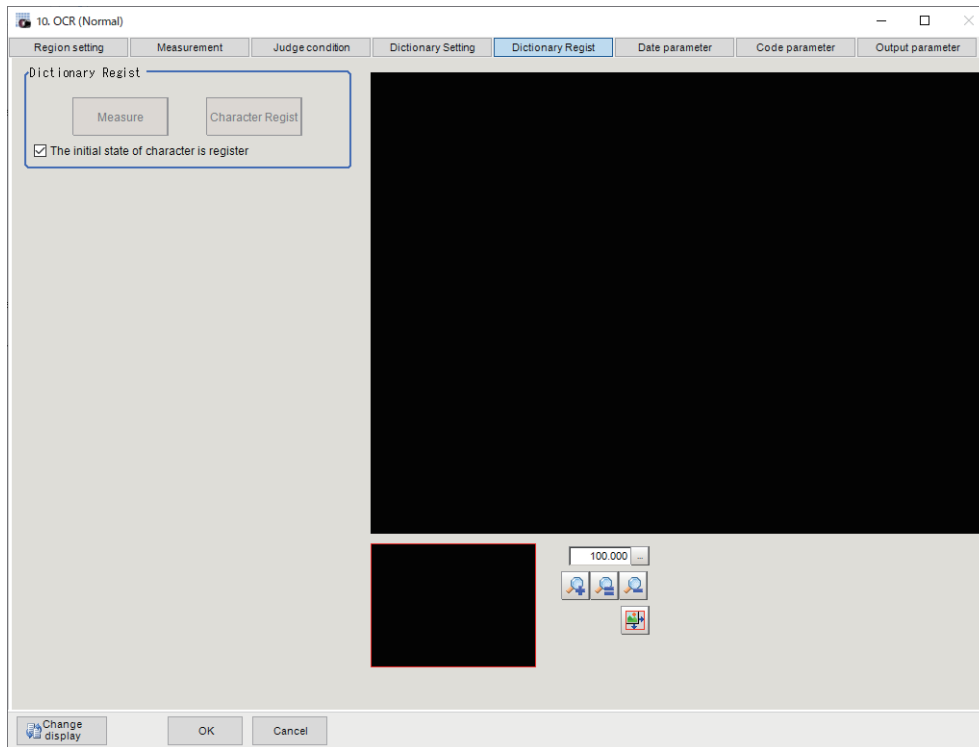

Precautions for Correct Use

If the **OCR User Dictionary** processing unit is not set on the **Dictionary Setting** tab, dictionary registration is not possible. Be sure to set the **Dictionary Setting** before **Dictionary Registration**.

- 1 In the Item Tab area, click **Dictionary Regist**.
- 2 In the *Dictionary Regist* area, set a value for each item.

Setting item	Setting value [Factory default]	Description
The initial state of code is register	<ul style="list-style-type: none"> • [Checked] • Unchecked 	To register all successfully characters measured after confirmation measurement in the dictionary, Place a check here in the The initial state of code is register . The registration state of each character after confirmation measurement will be "register".

- 3 Click **Measure**.
Measurement is executed and the results appear on the image.
The recognized characters are displayed as green squares.

- 4 Click the characters on the image.

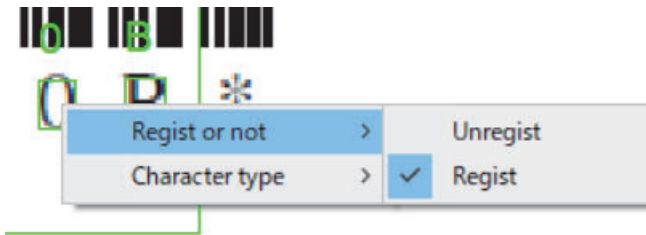

You can set *Register or not* and *Character* for the clicked characters.

Setting item	Setting value [Factory default]	Description
Register or not	<ul style="list-style-type: none"> [Unregist] Register 	To register the characters in the dictionary, select <i>Register</i> .
Character	0 to 9, A to Z, :/()	Sets the character type of the character to register. The measurement result is set automatically. If you want to change from the measurement result, change this setting.

- 5 Click **Character Register**.
The characters set with *Register* in **Register or not** and the character types set with **Character** are registered in the **OCR user dictionary** processing unit set in **Dictionary unit** on the **Dictionary Setting** tab, and the number of characters that were registered appears.

2-33-7 Date Parameters (OCR)

Set the date and time format and update conditions.

Based on the set date parameter, create a Verification string using the current date and time on the **Judge condition** tab. Then, it matches with the measurement results. (*Setting the Judgment Conditions for Verification String Matching Result* on page 2-517)

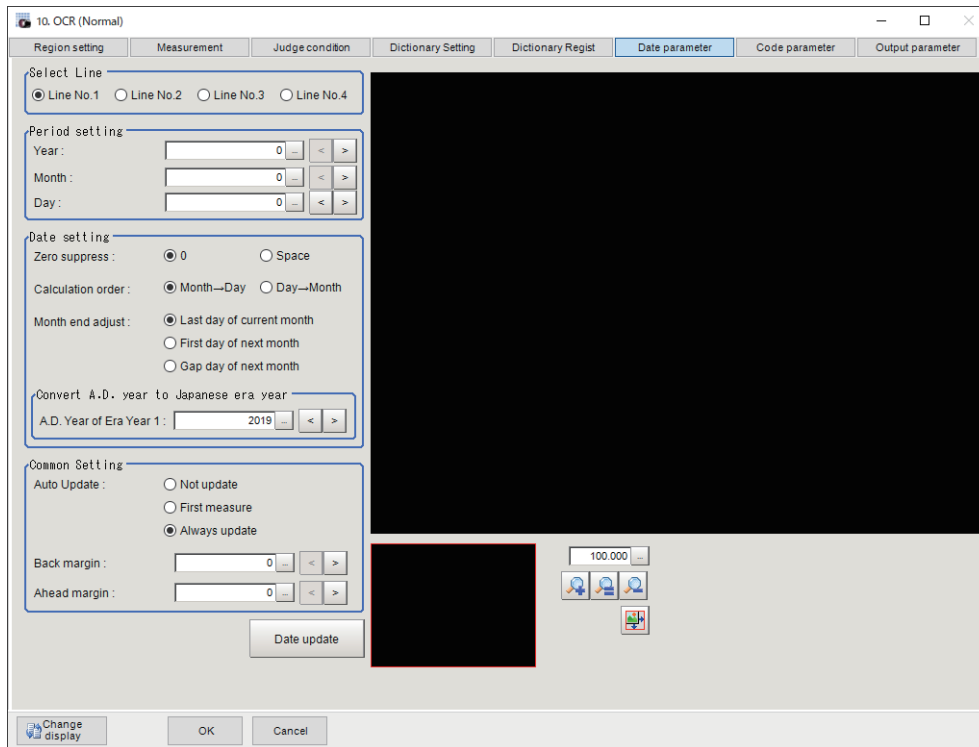

- 1 In the Item Tab area, click **Date parameter**.
- 2 In the *Select Line* (line selection) area, set a value for each item.

Setting item	Setting value [Factory default]	Description
Select line	<ul style="list-style-type: none"> • [Line No. 1] • Line No. 2 • Line No. 3 • Line No. 4 	Specifies a line to be used for the usage period with the subsequent setting menu.

- 3 When comparing with character strings with an expiration date limit, set each item in the *Period setting* area.

Setting item	Setting value [Factory default]	Description
Year	0 to 99 [0]	This item sets the usage period from the current date. Refer to "How to calculate a usage period".
Month	0 to 99 [0]	
Day	-999 to 999 [0]	

- 4 In the *Date setting* area, specify a value for each item.

Setting item	Setting value [Factory default]	Description
Zero suppress	<ul style="list-style-type: none"> • [0] • Space 	Set how the tens digits of the month and day are displayed.

Setting item	Setting value [Factory default]	Description
Calculation order	<ul style="list-style-type: none"> • [Month→Day] • Day→Month 	<p>Set whether to calculate the month first or the day first when the usage period is set.</p> <p>The date for the usage period varies depending on the calculating order, for instance, in the case where a month that has 31 days or 30 days is spanned.</p> <p>Select this according to the calculating method of the usage period.</p> <p>Refer to "How to calculate a usage period".</p>
Month end adjust	<ul style="list-style-type: none"> • [Last day of current month] • First day of next month • Gap day of next month 	<p>Set the adjustment method that will be used if the result of the expiration date calculation is an invalid date. Select this according to the calculating method of the usage period.</p> <p>Refer to "How to calculate a usage period".</p>

- 5** In the *Common setting* area, set a value for each item.
Clicking **Date update** updates the date information of the verification string.

Setting item	Setting value [Factory default]	Description
Auto Update	<ul style="list-style-type: none"> • Not update • First measure • [Always update] 	<p>Sets the year, month and day updating conditions. The clock time is always updated regardless of this setting.</p> <ul style="list-style-type: none"> • Not update This is not automatically updated. • First measure The data is updated at the first measurement after the Sensor Controller is started up. When it is not kept running more than one day, the date is updated at the first time measurement is performed after it is started up following a change of date. • Always update The date is updated when measurement is performed. When the Sensor Controller is kept running more than one day, the date is updated at the first time measurement is performed after the date changes.
Back margin	0 to 99 [0]	<p>Sets a time range up to the current time to be judged OK. The unit is minutes.</p> <p>Set when the printing time is different from the inspection time.</p>
Ahead margin	0 to 99 [0]	<p>Sets a time range up to the current time to be judged OK. The unit is minutes.</p> <p>Set when the printing time is different from the inspection time.</p>

● How to calculate a usage period

If a usage period is set and the date does not exist, such as 2/31, the calculated usage period date changes depending on the **Month end adjust** setting.

Use the following examples as reference for setting of the date parameter.

When the month end adjustment is not applied

Example 1:

- Measurement is performed on 2015/9/30, and the **Period setting** is: *Year: 0, Month: 1, Day: 1*.
The **Calculation order** is *Month→Day*.
A month is added to 9/30, and the result will be 10/30.
A day is added to 10/30, and the result will be 10/31.
Since 10/31 is a date existed, the month end adjustment will not be applied and the usage period will 2015/10/31.

Example 2:

- Measurement is performed on 2015/9/30, and the **Period setting** is: *Year: 0, Month: 1, Day: 1*.
The **Calculation order** is *Day→Month*.
A day is added to 9/30, and the result will be 10/1.
A month is added to 10/1, and the result will be 11/1.
Since 11/1 is a date existed, the month end adjustment will not be applied and the usage period will be 2015/11/1.

When the month end adjustment is applied:

Example 1:

- Measurement is performed on 2015/1/31, and the **Period setting** is: *Year: 0, Month: 1, Day: 1*.
The **Calculation order** is *Month→Day*.
A month is added to 1/31, and the result will be 2/31.
The month end adjustment will be applied since 2/31 does not exist.
The result of the month end adjustment plus 1 will be the verification string.

Month end adjust	Result	Calculated usage period
Last day of current month	Since the current month is February, the last day is 2015/2/28.	Add 1 day to 2/28, 2015/3/1
First day of next month	Since the current month is February, the start day of next month is 2015/3/1.	Add one day to 3/1, 2015/3/2
Gap day of next month	Since the current month is February, 2015/3/1 is the next month. There is a three-day gap between 2/28 existed and 2/31 calculated. Therefore, that day that one day shifts from existing 2/28 will be 3/3.	Add one day, 2015/3/4

Example 2:

- Measurement is performed on 2015/10/30, and the **Period setting** is: *Year: 0, Month: 1, Day: 1*.
The **Calculation order** is *Day→Month*.
A day is added to 10/30, and the result will be 10/31.
A month is added to 10/31, and the result will be 11/31.
The month end adjustment will be applied since 11/31 does not exist.

Month end adjust	Result	Calculated usage period
Last day of current month	The current month is November, the last day of the month is 2015/11/30.	2015/11/30
First day of next month	The current month is November, the start day of next month will be 2015/12/1.	2015/12/1

Month end adjust	Result	Calculated usage period
Gap day of next month	The current month is November, 2015/12/1 will be in next month. There is a one-day gap between existing 11/30 and 11/31 calculated. Therefore, the day that one day shifts from existing 11/30 will be 12/1.	2015/12/1

2-33-8 Code Parameters (OCR)

Preset what the codes show so that date verification is possible even when printing the date encrypted in such a way that it is difficult for the user to recognize.

Based on the set encryption parameters, create a collation character string on the **Judge condition** tab and collate it with the read character string.

If the usage period is not set in the **Date parameter** tab, use the encrypted year / month / day / hour / minute (eY1, eM1, eD1, eR1, eN1, eY2, eM2, eD2, eR2, eN2) is set in the **Verification string** on the **Judge condition** tab.

If the usage period is set on the **Date parameter** tab, use the year / month / day (iY1, iM1, iD1, iY2, iM2, iD2) after setting the encrypted period for the **Verification string** on the **Judge condition** tab.

The setting methods are to set on the screen or set with a PC.

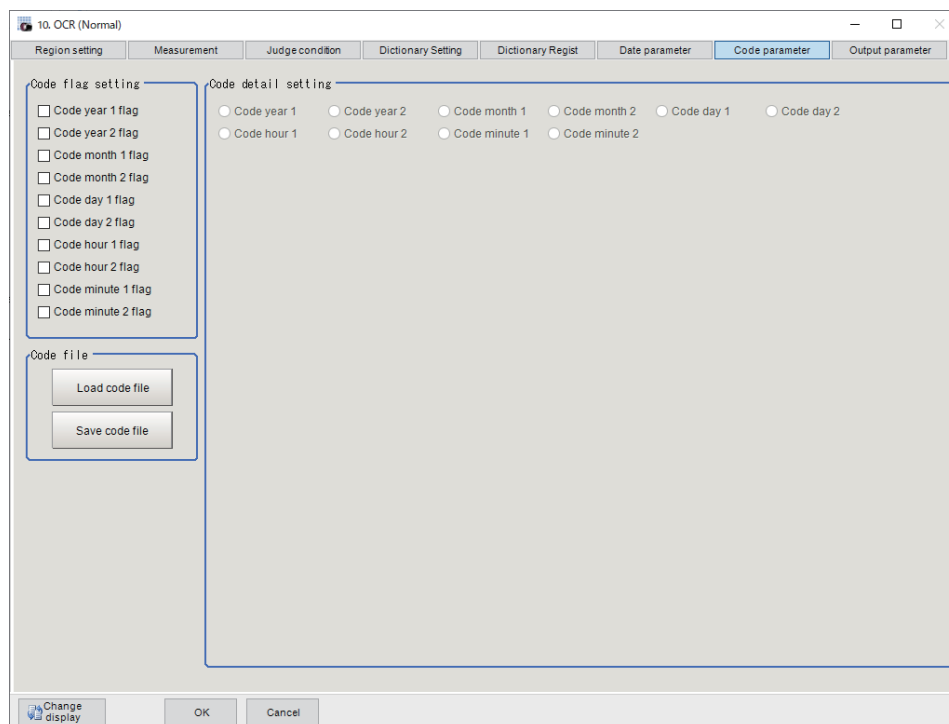

Setting on the Screen

This describes the setting method, using an example in which October is encrypted as X.

- 1** In the Item Tab area, click **Code parameter**.
- 2** In the *Code flag setting* area, place a check at **Code month 1 flag**.

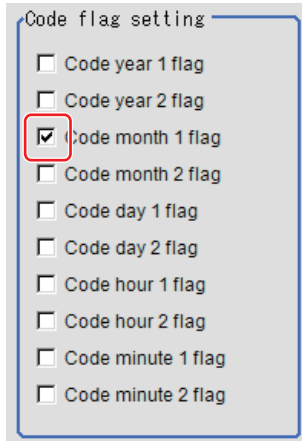

Code flag setting

- Code year 1 flag
- Code year 2 flag
- Code month 1 flag
- Code month 2 flag
- Code day 1 flag
- Code day 2 flag
- Code hour 1 flag
- Code hour 2 flag
- Code minute 1 flag
- Code minute 2 flag



Additional Information

- Code month 1 and code month 2:
Set up code for 2 patterns in order to be ready for setup changes. Select a check at the one to use.

- 3** Place a check at **Code month 1** in the *Code detail setting* area.

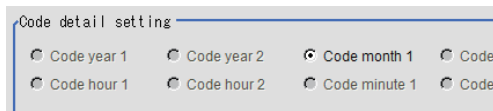

Code detail setting

Code year 1 Code year 2 Code month 1 Code
 Code hour 1 Code hour 2 Code minute 1 Code

- 4** Click ... for 10.
The software keyboard is displayed. Input X.
Input a character string of up to 4 characters.

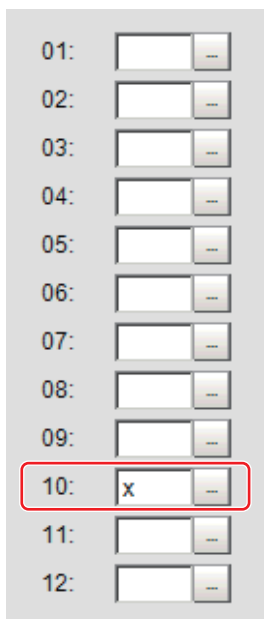

01: --

02: --

03: --

04: --

05: --

06: --

07: --

08: --

09: --

10: --

11: --

12: --

Setting with a PC

Code parameters are complex, so performing the settings with a PC makes file editing easier and minimizes mistakes.

Saving an empty CSV file first and then editing and reading it with a PC makes setting the values more efficient.

● Saving code files

Make an empty file for editing on the PC.

If encryption parameters are already set on the screen, a file reflecting those settings is saved.

- 1 In the Item Tab area, click **Code parameter**.
- 2 In the *Code flag setting* area, place a check at the flag used in the encrypted character strings to be edited.



- 3 In the *Code file* area, click **Save code file**.

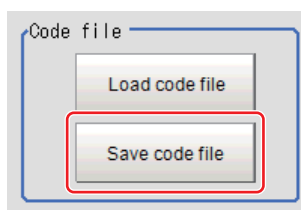

- 4 Set the save destination folder and file name, and click **OK**.
The code file is saved (in CSV format).

● Code file format

- The first line shows the *Code*.
- The second line shows the *Flag*. Input 1 when used.
- The third line and subsequent lines contain codes for each number.
Months and days start from 1.

Code	Year1	Year2	Month1	Month2	Day1	Day2	Hour1	Hour2	Minute1	Minute2
Flag										
0										
1										
2										
3										
4										
5										
6										
7										
8										
9										
10										
11										
12										
13										
14										
15										
16										
17										
18										
19										
20										
21										
22										
23										
24										
25										
26										
27										
28										
29										
30										
31										
32										
.										
.										
.										
98										
99										

● Reading code files

- 1** In the Item Tab area, click **Code parameter**.
- 2** In the *Code file* area, click **Load code file**.

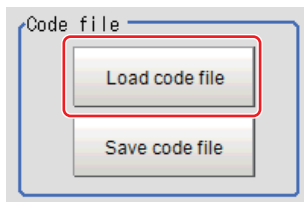

- 3** In the file selection window, select the code file (in CSV format) to read and click **OK**.
The code file is read and the content is displayed in the window.

2-33-9 Output Parameters (OCR)

Use this item to change the output parameters.

The output parameters are the conditions and parameters for outputting measurement results to other processing units or external devices. Normally, the factory default values can be used.

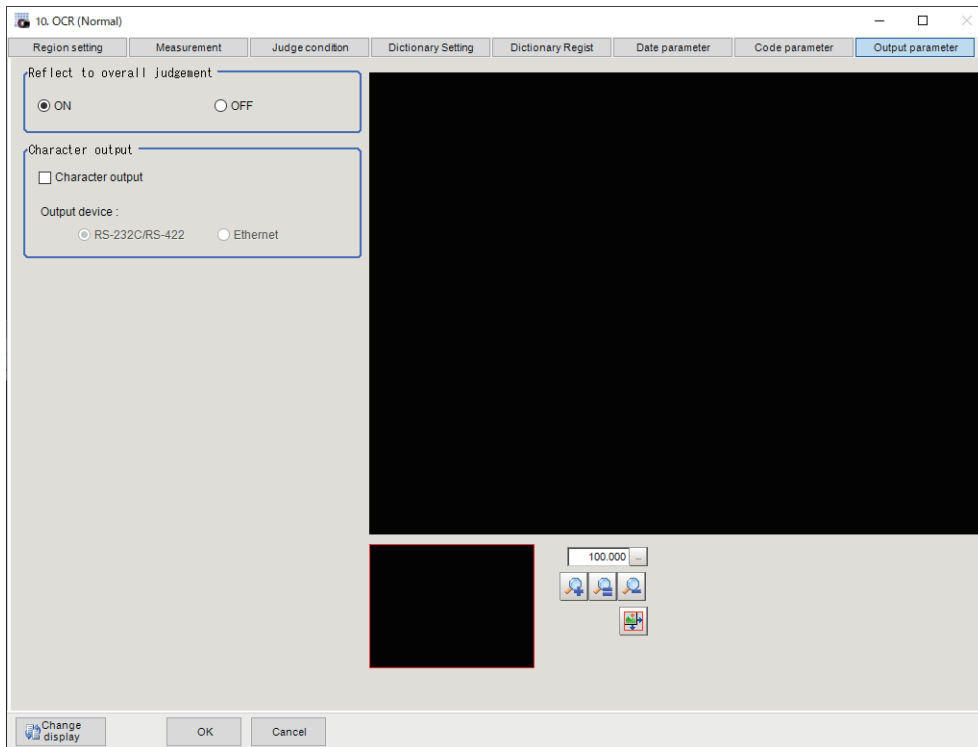

Additional Information

If there are no character strings to read when character string outputs, no data will be output.

- 1 Click **Output parameter** in the Item Tab area.
- 2 Specify a value for each item.

Setting item	Setting value [Factory default]	Description
Reflect to overall judgment	<ul style="list-style-type: none"> • [ON] • OFF 	Enables choosing whether or not the judgement results of this processing unit is reflected in the scene overall judgment.

Setting item		Setting value [Factory default]	Description
Character output	Character output	<ul style="list-style-type: none"> • Checked • [Unchecked] 	Specifies whether to output read-in character strings to an external device.
	Output device	<ul style="list-style-type: none"> • [RS-232C / RS-422] • Ethernet 	<p>This is valid only when a check is placed in the <i>Character output</i>.</p> <p>Specifies the destination for the character output. When kanji or other characters that are not ASCII codes are included, they are not output correctly.</p> <p>The output destination is Serial (RS-232C / 422) or Serial (Ethernet) selected in the Communication of the System Settings. The setting of the IP address of the serial (Ethernet) output destination also follows the System Settings.</p> <p>*1</p> <p>For details, refer to <i>Non-procedure Communications</i> in the <i>Vision System FH/FHV Series User's Manual for Communications Settings (Cat. No. Z342)</i>.</p> <p>The character string is output as follows.</p> <ul style="list-style-type: none"> • When only one line is output Normal: String + NULL + Delimiter (CR) PLC Link: String + NULL + NULL • When two lines are output Normal: String + NULL + String + NULL + Delimiter (CR) PLC Link: String + NULL + String + NULL + NULL

*1. RS-422 is unavailable in the FH/FHV series.

Output of Character String in PLC Link

In PLC Link communication, if you check the **Character output** in the **Output parameter** tab, the character string and NULL(00 hex)+NULL(00 hex) are output to the data output area of PLC Link.

● Output Format

Take the following case as an example. Number of measurement is one. Reading character string is 32. Command: Read character strings 0123456789...UV, Command, Response, and Data Output area are as follows.

For details, refer to *Communicating with PLC Link, Command Details for PLC Link, EtherNet/IP, and EtherCAT* in *Vision System FH/FHV Series User's Manual for Communications Settings (Cat. No. Z342)*.



Additional Information

If no character string, no data will be output.

- Command (PLC to Sensor Controller)

Command Area		Description
Top Channel +3	Top Channel +2	
0010	1010	Performs one measurement.

- Response (Sensor Controller to PLC)

Response Area		Description
Top Channel	Data	
+2	1010	Command Code: Target command code is responded.
+3	0010	
+4	0000	Response code: Command execution result.
+5	0000	

- Data Output Area (Sensor Controller to PLC)

When read the 32 character strings (0123456789...UV), the result continues as follows. ASCII code data + NULL (00 hex) + NULL (00 hex)

Top channel	Name	Description
+0	1st character, 2nd character	3031 (ASCII code of the character 0, ASCII code of the character 1)
+1	3rd character, 4th character	3233 (ASCII code of the character 2, ASCII code of the character 3)
:	:	:
+15	31st character, 32nd character	5556 (ASCII code of the character U, ASCII code of the character V)
+16	NULL, NULL	NULL (00 hex) + NULL (00 hex)

● How to get the character string

Perform the Data Output Request (DSA) and Data Output Completion (GATE) as in the case of Data Output.

All character string is included in one data. Thereby, Data Output Request (DSA) is performed once if there is one Character Inspection unit.

Output of Character String with Non-procedure Communications

Check the **Character output** in the **Output parameter** tab to output the character string with Non-procedure communication.

● Output Format

Take the following case as an example. Number of measurement is one. Reading character string is 32. Command: Read character strings 0123456789...UV, Command, Response, and Data Output area are as follows.

For details, refer to *Non-procedure Communications* and *MEASURE* or *M* in *Non-procedure Command Details* in *Vision System FH/FHV Series User's Manual for Communications Settings* (Cat. No. Z342).

- Command (PLC to Sensor Controller)

M	E	A	S	U	R	E	C _R
---	---	---	---	---	---	---	----------------

 or

M	C _R
---	----------------

- Response (Sensor Controller to PLC)

O	K	C _R
---	---	----------------

0123456789...UV(Character string data)	NULL(00 hex)	C _R
--	--------------	----------------

Output of Character String with EtherNet/IP Message Communications

In EtherNet/IP message communication, output of character string is possible using UNITDATA command which acquires the measurement value. Outputs the character string data measured and NULL (00 hex).

For details, refer to *Communicating with the Sensor Controller with EtherNet/IP Message Communications, Non-procedure Communications and UNITDATA or UD in Non-procedure Command Details in Vision System FH/FHV Series User's Manual for Communications Settings (Cat. No. Z342)*.

● Output Format

Take the following case as an example. Number of measurement is one. Reading character string is 32. Command: Read character strings 0123456789...UV, Command, Response, and Data Output area are as follows. Described example is only a part of Attribute.



Additional Information

- When character strings in multiple lines are output, change the external reference table No. of UNITDATA, and then read the character strings.
 - Command (PLC to Sensor Controller)
Specify the command character string equivalent to a non-procedure command.
Attach NULL(00 hex) at the end of the character string. No line feed code is required.
The size of the send data includes the NULL(00 hex) at the end of the character string.
- NULL(00 hex)

External reference table

Processing Unit No. (Max. 4 digit)
- Response (Sensor Controller to PLC)
Character string data equivalent to the Non-procedure command reception character string is returned.
NULL (00 hex) is inserted in the reception character string delimiter section.
The size of the reception data includes the final NULL(00 hex).

0123456789...UV(Character string data) NULL(00 hex) O(4F hex) K(4B hex) NULL(00 hex)

Output of Character String with Result Output (I/O) with EtherNet/IP

Use the **Result Output (I/O)** processing unit to output the read string.

For details, refer to *Communicating by EtherNet/IP - Setting Output Data (Numerical Values and Character Strings)* in the *Vision System FH/FHV Series User's Manual for Communications Settings (Cat. No. Z342)*.

Output of Character String with Result Output (I/O) with EtherCAT

Use the **Result Output (I/O)** processing unit to output the read string.

For details, refer to *EtherCAT Connections - Setting Output Data (Numerical Values and Character Strings)* in the *Vision System FH/FHV Series User's Manual for Communications Settings (Cat. No. Z342)*.

Output of Character String with Result Output (I/O) with PROFINET

Use the **Result Output (I/O)** processing unit to output the read string.

For details, refer to *Communicating by PROFINET - Setting Output Data (Numerical Values and Character Strings)* in the *Vision System FH/FHV Series User's Manual for Communications Settings (Cat. No. Z342)*.

2-33-10 Key Points for Test Measurement and Adjustment (OCR)

The following content is displayed in the *Detail result* area as text.

Displayed item	Description
Judge	Judgment results 0: No judgment (unmeasured) 1: Judgment result OK -1: Judgment result NG -10: Error (image format mismatch) -11: Error (unregistered model) -12: Error (insufficient memory) -20: Error (other errors)
NG cause	When the judgment result of the processing unit is NG, a description of the NG is shown as the NG cause. 0: OK 1: OCV NG 2: Similarity NG 3: OCV NG, Similarity NG 4: Stability NG 5: OCV NG, Stability NG 6: Similarity NG, Stability NG 7: OCV NG, Similarity NG, Stability NG 8: Character count NG 9: OCV NG, Character count NG 10: Similarity NG, Character count NG 11: OCV NG, Similarity NG, Character count NG 12: Stability NG, Character count NG 13: OCV NG, Stability NG, Character count NG 14: Similarity NG, Stability NG, Character count NG 15: OCV NG, Similarity NG, Stability NG, Character count NG
Char. count	The number of measured characters is displayed.
Detected character string	Detected character string
Target string	Displays the verification string

The image specified in the Sub-image number in the image display setting is displayed in the *Image Display* area.

Sub-image number	Description of image to be displayed
0	Measurement image

Key Points for Adjustment (OCR)

Adjust the setting parameters referring to the following points.

● When teaching fails

Parameter to be adjusted	Remedy
Measurement parameter	You may have used the <i>Fast</i> mode to measure a character string with a narrow interval between characters. Set the read mode to <i>Normal</i> .
	The String format (character string format) setting or correct string may not match the characters being read. Set a character string format that matches the characters being read.
	The characters being measured may have a large height or a large width. Set a maximum aspect ratio for "Max aspect ratio" in "Detail setting" so that the ratio accords with the length and width of the characters being read. You can check the shape of the characters in the cut-out image display.
	It is possible that a hyphen - or colon : is misrecognized. In "Detail setting", set upper and lower limits for <i>Hyphen Threshold</i> (hyphen height) that accord with the characters being read.
	The characters being read may have a long and thin shape. Set a maximum character height for "Max Height" that accords with the shape of the characters being read. You can check the shape of the characters in the cut-out image display.
	The characters being read may be in close proximity to peripheral characters. Set the following parameters in the detailed settings. <ul style="list-style-type: none"> • Set a smaller value for the <i>Thick Threshold</i> (the thickness level). • Set a smaller value for <i>Dot Pitch X</i> (the vertical dot interval) or <i>Dot Pitch Y</i> (the horizontal dot interval). • Select the <i>Max Width Setting</i> (maximum character width) checkbox and set the maximum character width.
	The characters being read might be faint, fine, or broken. Set the following parameters in the detailed settings. <ul style="list-style-type: none"> • Set a larger value for the <i>Thick Threshold</i> (the thickness level). • Set a larger value for <i>Dot Pitch X</i> (the vertical dot interval) or <i>Dot Pitch Y</i> (the horizontal dot interval).
Dictionary Regist	The character being read may be similar to another character in the dictionary in the processing item. Register the character being read in the dictionary.

- **When the measurement results are unstable**

Parameter to be adjusted	Remedy
Measurement parameter	<p>The String format (character string format) setting or correct string may not match the characters being read. Set a character string format that matches the characters being read.</p> <p>You may have used the <i>Fast</i> mode to measure a character string with a narrow interval between characters. Set the read mode to <i>Normal</i>.</p> <p>The characters being measured may have a large height or a large width. Set a maximum aspect ratio for the <i>Max aspect ratio</i> in the <i>Detail setting</i> so that the ratio accords with the length and width of the characters being read. You can check the shape of the characters in the cut-out image display.</p>
-	<p>Conducting pre-processing is effective for the following cases: measured images have noise or surface irregularity, target characters have low contrast, the background has dusts or patterns, etc. In such cases, some pre-processing with the measuring image may improve the performance of reading. (<i>Section 3 Compensate Image</i> on page 3-1)</p>

- **When a specific character is misrecognized**

Parameter to be adjusted	Remedy
Dictionary Regist	<p>The character being read may be similar to another character in the dictionary in the processing item. Register the character being read in the dictionary.</p>

- **The result of date verification does not stabilize**

Parameter to be adjusted	Remedy
Date parameter	<p>One-digit and two-digit formats may be mixed together in the printed month/day. In the date settings, change the "Zero suppress" (10's digit display) setting to match the actual printed format.</p>

- **When the processing speed is slow**

Parameter to be adjusted	Remedy
Region setting	<p>The measurement processing time might take longer because the measurement region is broad. Set the measurement region as narrow as possible.</p>
Measurement parameter	<p>You may be using <i>Normal</i> mode to measure a character string with a large interval between characters. Set the <i>Read mode</i> to <i>Fast</i>.</p>
Date parameter	<p>In date verification, the margin set before and after the date may be too large. For date verification, set the <i>Back margin</i> and <i>Ahead margin</i> to a smaller value.</p>

2-33-11 Measurement Results for Which Output is Possible (OCR)

The following values can be output using processing items related to result output. It is also possible to reference measurement values from calculation expressions and other processing units.

Measurement items	Character string	Description
Judge	JG	Judgment results 0: No judgment (unmeasured) 1: Judgment result OK -1: Judgment result NG -10: Error (image format mismatch) -11: Error (unregistered model) -12: Error (insufficient memory) -20: Error (other errors)
Number of characters 1	NUM0	No. of characters on the 1st line
Number of characters 2	NUM1	No. of characters on the 2nd line
Number of characters 3	NUM2	No. of characters on the 3rd line
Number of characters 4	NUM3	No. of characters on the 4th line
Judgement1	LNG0	NG cause of 1st line
Judgement2	LNG1	NG cause of 2nd line
Judgement3	LNG2	NG cause of 3rd line
Judgement4	LNG3	NG cause of 4th line

2-33-12 External Reference Tables (OCR)

No.	Data name	Data ident	Set/Get	Data range
0	Judge	judge	Get only	0: No judgment (unmeasured), 1: Judgment result OK, -1: Judgment result NG, -10: Error (image format mismatch), -11: Error (unregistered model), -12: Error (insufficient memory), -20: Error (other errors)
1	Chara. Num (Line No.1)	characterNum0	Get only	0 to 32
2	Chara. Num (Line No.2)	characterNum1	Get only	0 to 32
3	Chara. Num (Line No.3)	characterNum2	Get only	0 to 32
4	Chara. Num (Line No.4)	characterNum3	Get only	0 to 32
5	NG Cause (Line No.1)	lineNGCause0	Get only	0x0000 to 0x000F
6	NG Cause (Line No.2)	lineNGCause1	Get only	0x0000 to 0x000F
7	NG Cause (Line No.3)	lineNGCause2	Get only	0x0000 to 0x000F
8	NG Cause (Line No.4)	lineNGCause3	Get only	0x0000 to 0x000F
20	Read string (Line No.1)	readString0	Get only	Character string
21	Read string (Line No.2)	readString1	Get only	Character string

No.	Data name	Data ident	Set/Get	Data range
22	Read string (Line No.3)	readString2	Get only	Character string
23	Read string (Line No.4)	readString3	Get only	Character string
30	Target String (Line No.1)	targetString0	Get only	Character string
31	Target String (Line No.2)	targetString1	Get only	Character string
32	Target String (Line No.3)	targetString2	Get only	Character string
33	Target String (Line No.4)	targetString3	Get only	Character string
103	Reflect to overall judgement	overallJudge	Set/Get	0: ON, 1: OFF
104	Character output	outputFlag	Set/Get	0: OFF, 1: ON
105	Character output destination	outputDevice	Set/Get	0: RS-232C/RS-422 *1 1: Ethernet
110	Read Mode	readMode	Set/Get	0: Standard, 1: Fast
120	Character color	characterColor	Set/Get	0: Black, 1: White
121	Delete Frame	deleteFrame	Set/Get	0: OFF, 1: ON
122	Italic Robust	italicRobust	Set/Get	0: OFF, 1: ON
123	Rotation Robust	rotationRobust	Set/Get	0: OFF, 1: ON
124	Hyphen Low Threshold	hyphenHighThreshold	Set/Get	0 to 100
125	Hyphen High Threshold	hyphenLowThreshold	Set/Get	0 to 100
126	Font No.	fontNo	Set/Get	0: Common dictionary 1: Dot dictionary
127	Thick Threshold	threshold	Set/Get	-128 to 128
128	Dot Pitch X	dotPitchX	Set/Get	0 to 99
129	Dot pitch Y	dotPitchY	Set/Get	0 to 99
130	Max Width Setting Flag	maxWidthSettingManual	Set/Get	0: OFF, 1: ON
131	Max Width	maxWidth	Set/Get	0 to 9,999
132	Max Height	maxHeight	Set/Get	0 to 9,999
133	Min Height [%]	minHeight	Set/Get	0 to 100
135	Max aspect ratio	longCharaThreshold	Set/Get	1 to 10
136	Inspection mode	checkMode	Set/Get	0: OCR, 1: OCR + Count, 2: OCV
137	Similarity/Stability Individual setting	respectiveSetting	Set/Get	0: OFF, 1: ON
138	Lower Limit of similarity	judgeScore	Set/Get	0 to 100
139	Lower Limit of stability	judgeDiff	Set/Get	0 to 100
140	Dictionary Scene No.	dicScene	Set/Get	-1: Current scene 0 to 9,999: Scene No.
141	Dictionary Unit No.	dicUnit	Set/Get	-1: OFF 0 to 9,999: Unit No.

No.	Data name	Data ident	Set/Get	Data range
142	Teach without correct result	liteTeach	Set/Get	0: OFF, 1: ON
143	The initial state of character is register	isRegisterAll	Set/Get	0: OFF, 1: ON
144	Setting type of reference verification string	checkSet	Set/Get	0: Direct, 1: Unit
145	Setting unit of reference verification string	unitChoose	Set/Get	-1: OFF 0 to 9,999: Ref. unit No.
200	Teaching String (Line No.1)	teachString0	Set/Get	Character string
201	Teaching String (Line No.2)	teachString1	Set/Get	Character string
202	Teaching String (Line No.3)	teachString2	Set/Get	Character string
203	Teaching String (Line No.4)	teachString3	Set/Get	Character string
210	Format String (Line No.1)	formatString0	Set/Get	Character string
211	Format String (Line No.2)	formatString1	Set/Get	Character string
212	Format String (Line No.3)	formatString2	Set/Get	Character string
213	Format String (Line No.4)	formatString3	Set/Get	Character string
220	Target string expression (Line No.1)	compareString0	Set/Get	Character string
221	Target string expression (Line No.2)	compareString1	Set/Get	Character string
222	Target string expression (Line No.3)	compareString2	Set/Get	Character string
223	Target string expression (Line No.4)	compareString3	Set/Get	Character string
230	Lower Limit of Chara. Num (Line No.1)	lowerCharacter-Count0	Set/Get	1 to 32
231	Lower Limit of Chara. Num (Line No.2)	lowerCharacter-Count1	Set/Get	1 to 32
232	Lower Limit of Chara. Num (Line No.3)	lowerCharacter-Count2	Set/Get	1 to 32
233	Lower Limit of Chara. Num (Line No.4)	lowerCharacter-Count3	Set/Get	1 to 32
240	Upper Limit of Chara. Num (Line No.1)	upperCharacter-Count0	Set/Get	1 to 32

No.	Data name	Data ident	Set/Get	Data range
241	Upper Limit of Chara. Num (Line No.2)	upperCharacter-Count1	Set/Get	1 to 32
242	Upper Limit of Chara. Num (Line No.3)	upperCharacter-Count2	Set/Get	1 to 32
243	Upper Limit of Chara. Num (Line No.4)	upperCharacter-Count3	Set/Get	1 to 32
250	Lower limit of verification string (Line No.1)	unitCompareLow0	Set/Get	1 to 3,200
251	Lower limit of verification string (Line No.2)	unitCompareLow1	Set/Get	1 to 3,200
252	Lower limit of verification string (Line No.3)	unitCompareLow2	Set/Get	1 to 3,200
253	Lower limit of verification string (Line No.4)	unitCompareLow3	Set/Get	1 to 3,200
260	Upper limit of verification string (Line No.1)	unitCompareUpp0	Set/Get	1 to 3,200
261	Upper limit of verification string (Line No.2)	unitCompareUpp1	Set/Get	1 to 3,200
262	Upper limit of verification string (Line No.3)	unitCompareUpp2	Set/Get	1 to 3,200
263	Upper limit of verification string (Line No.4)	unitCompareUpp3	Set/Get	1 to 3,200
270	Verification string (Line No.1) flag	chkChoose1	Set/Get	0: Disable, 1: Enable
271	Verification string (Line No.2) flag	chkChoose2	Set/Get	0: Disable, 1: Enable
272	Verification string (Line No.3) flag	chkChoose3	Set/Get	0: Disable, 1: Enable
273	Verification string (Line No.4) flag	chkChoose4	Set/Get	0: Disable, 1: Enable
300+N (N=0 to 40)	Lower Limit of similarity	lowerScore00 to lowerScore40	Set/Get	0 to 100
400+N (N=0 to 40)	Lower Limit of stability	lowerDiff00 to lowerDiff40	Set/Get	0 to 100
500+N (N=0 to 40)	Dictionary Enable Flag	enableDB00 to enableDB40	Set/Get	0: Not used, 1: Used
1,128	Auto Update	autoUpdate	Set/Get	0: Not update, 1: First measurement after startup, 2: Always update
1,132	Back margin	forwardMargin	Set/Get	0 to 99

No.	Data name	Data ident	Set/Get	Data range
1,133	Ahead margin	backMargin	Set/Get	0 to 99
1,134	Code year 1 flag	flagYear1	Set/Get	0: Not used, 1: Used
1,135	Code year 2 flag	flagYear2	Set/Get	0: Not used, 1: Used
1,136	Code month 1 flag	flagMonth1	Set/Get	0: Not used, 1: Used
1,137	Code month 2 flag	flagMonth2	Set/Get	0: Not used, 1: Used
1,138	Code day 1 flag	flagDay1	Set/Get	0: Not used, 1: Used
1,139	Code day 2 flag	flagDay2	Set/Get	0: Not used, 1: Used
1,140	Code hour 1 flag	flagHour1	Set/Get	0: Not used, 1: Used
1,141	Code hour 2 flag	flagHour2	Set/Get	0: Not used, 1: Used
1,142	Code minute 1 flag	flagMinute1	Set/Get	0: Not used, 1: Used
1,143	Code minute 2 flag	flagMinute2	Set/Get	0: Not used, 1: Used
1,150	String year 1 flag	stringYear1	Set/Get	Character string
1,151	String year 2 flag	stringYear2	Set/Get	Character string
1,152	String month 1 flag	stringMonth1	Set/Get	Character string
1,153	String month 2 flag	stringMonth2	Set/Get	Character string
1,154	String day 1 flag	stringDay1	Set/Get	Character string
1,155	String day 2 flag	stringDay2	Set/Get	Character string
1,156	String hour 1 flag	stringHour1	Set/Get	Character string
1,157	String hour 2 flag	stringHour2	Set/Get	Character string
1,158	String minute 1 flag	stringMinute1	Set/Get	Character string
1,159	String minute 2 flag	stringMinute2	Set/Get	Character string
1,160	Operation code number	operateStringNo	Set/Get	0 to 99
2,000	Term year (Line No.1)	termYear0	Set/Get	0 to 99
2,001	Term year (Line No.2)	termYear1	Set/Get	0 to 99
2,002	Term year (Line No.3)	termYear2	Set/Get	0 to 99
2,003	Term year (Line No.4)	termYear3	Set/Get	0 to 99
2,004	Term month (Line No.1)	termMonth0	Set/Get	0 to 99
2,005	Term month (Line No.2)	termMonth1	Set/Get	0 to 99
2,006	Term month (Line No.3)	termMonth2	Set/Get	0 to 99
2,007	Term month (Line No.4)	termMonth3	Set/Get	0 to 99
2,008	Term day (Line No.1)	termDay0	Set/Get	-999 to +999
2,009	Term day (Line No.2)	termDay1	Set/Get	-999 to +999
2,010	Term day (Line No.3)	termDay2	Set/Get	-999 to +999
2,011	Term day (Line No.4)	termDay3	Set/Get	-999 to +999
2,012	Zero suppress (Line No.1)	zeroSuppress0	Set/Get	0: 0, 1: Space
2,013	Zero suppress Line No.2)	zeroSuppress1	Set/Get	0: 0, 1: Space
2,014	Zero suppress (Line No.3)	zeroSuppress2	Set/Get	0: 0, 1: Space

No.	Data name	Data ident	Set/Get	Data range
2,015	Zero suppress (Line No.4)	zeroSuppress3	Set/Get	0: 0, 1: Space
2,016	Calculation order (Line No.1)	orderMonthDay0	Set/Get	0: Month → Day 1: Day → Month
2,017	Calculation order (Line No.2)	orderMonthDay1	Set/Get	0: Month → Day 1: Day → Month
2,018	Calculation order (Line No.3)	orderMonthDay2	Set/Get	0: Month → Day 1: Day → Month
2,019	Calculation order (Line No.4)	orderMonthDay3	Set/Get	0: Month → Day 1: Day → Month
2,020	Month end adjust (Line No.1)	adjustMonthEnd0	Set/Get	0: Last day of current month, 1: First day of next month, 2: Gap day of next month
2,021	Month end adjust (Line No.2)	adjustMonthEnd1	Set/Get	0: Last day of current month, 1: First day of next month, 2: Gap day of next month
2,022	Month end adjust (Line No.3)	adjustMonthEnd2	Set/Get	0: Last day of current month, 1: First day of next month, 2: Gap day of next month
2,023	Month end adjust (Line No.4)	adjustMonthEnd3	Set/Get	0: Last day of current month, 1: First day of next month, 2: Gap day of next month
2,024	A.D. Year of Era Year 1 (Line No.1)	firstYearJpnEra0	Set/Get	0 to 9,999
2,025	A.D. Year of Era Year 1 (Line No.2)	firstYearJpnEra1	Set/Get	0 to 9,999
2,026	A.D. Year of Era Year 1 (Line No.3)	firstYearJpnEra2	Set/Get	0 to 9,999
2,027	A.D. Year of Era Year 1 (Line No.4)	firstYearJpnEra3	Set/Get	0 to 9,999
3,000+N (N=0 to 99)	String year 1 data	stringYear1_00 to stringYear1_99	Set/Get	Character string
3,100+N (N=0 to 99)	String year 2 data	stringYear2_00 to stringYear2_99	Set/Get	Character string
3,200	String month 1 data 1	stringMonth1_00	Set/Get	Character string
:	:	:	:	:
3,211	String month 1 data 12	stringMonth1_11	Set/Get	Character string
3,300	String month 2 data 1	stringMonth2_00	Set/Get	Character string
:	:	:	:	:
3,311	String month 2 data 12	stringMonth2_11	Set/Get	Character string
3,400	String day 1 data 1	stringDay1_00	Set/Get	Character string
:	:	:	:	:
3,430	String day 1 data 31	stringDay1_30	Set/Get	Character string
3,500	String day 2 data 1	stringDay2_00	Set/Get	Character string
:	:	:	:	:
3,530	String day 2 data 31	stringDay2_30	Set/Get	Character string

No.	Data name	Data ident	Set/Get	Data range
3,600+N (N=0 to 23)	String hour 1 data	stringHour1_00 to stringHour1_23	Set/Get	Character string
3,700+N (N=0 to 23)	String hour 2 data	stringHour2_00 to stringHour2_23	Set/Get	Character string
3,800+N (N=0 to 59)	String minute 1 data	stringMinute1_00 to stringMinute1_59	Set/Get	Character string
3,900+N (N=0 to 59)	String minute 2 data	stringMinute2_00 to stringMinute2_59	Set/Get	Character string
10,000+N (N=0 to 31)	Character code (Line No.1)	charCode0_00 to charCode0_31	Get only	0 to 0xFFFF
11,000+N (N=0 to 31)	Character code (Line No.2)	charCode1_00 to charCode01_31	Get only	0 to 0xFFFF
12,000+N (N=0 to 31)	Character code (Line No.3)	charCode02_00 to charCode02_31	Get only	0 to 0xFFFF
13,000+N (N=0 to 31)	Character code (Line No.4)	charCode3_00 to charCode3_31	Get only	0 to 0xFFFF
20,000+N (N=0 to 31)	NG Cause (Line No.1)	ngCause0_00 to ngCause0_31	Get only	0 to 15
21,000+N (N=0 to 31)	NG Cause (Line No.2)	ngCause1_00 to ngCause1_31	Get only	0 to 15
22,000+N (N=0 to 31)	NG Cause (Line No.3)	ngCause2_00 to ngCause2_31	Get only	0 to 15
23,000+N (N=0 to 31)	NG Cause (Line No.4)	ngCause3_00 to ngCause3_31	Get only	0 to 15
30,000+N (N=0 to 31)	Similarity (Line No.1)	similarity0_00 to sim- ilarity0_31	Get only	0 to 100
31,000+N (N=0 to 31)	Similarity (Line No.2)	similarity1_00 to sim- ilarity1_31	Get only	0 to 100
32,000+N (N=0 to 31)	Similarity (Line No.3)	similarity2_00 to sim- ilarity2_31	Get only	0 to 100
33,000+N (N=0 to 31)	Similarity (Line No.4)	similarity3_00 to sim- ilarity3_31	Get only	0 to 100
40,000+N (N=0 to 31)	Stability (Line No.1)	stability0_00 to sta- bility0_31	Get only	0 to 100
41,000+N (N=0 to 31)	Stability (Line No.2)	stability1_00 to sta- bility1_31	Get only	0 to 100
42,000+N (N=0 to 31)	Stability (Line No.3)	stability2_00 to sta- bility2_31	Get only	0 to 100
43,000+N (N=0 to 31)	Stability (Line No.4)	stability3_00 to sta- bility3_31	Get only	0 to 100
90,000	figure0 Count	figArea0_count	Set/Get	1
90,001	figure0 Type	figArea0_fig0_type	Set/Get	8: Rectangle
90,002	figure0 mode	figArea0_fig0_mode	Set/Get	0: OR
90,014	figure0 Rectangle Upper left position X	figAr- ea0_fig0_box_X0	Set/Get	-99,999 to 99,999
90,015	figure0 Rectangle Upper left position Y	figAr- ea0_fig0_box_Y0	Set/Get	-99,999 to 99,999
90,016	figure0 Rectangle Lower right position X	figAr- ea0_fig0_box_X1	Set/Get	-99,999 to 99,999

No.	Data name	Data ident	Set/Get	Data range
90,017	figure0 Rectangle Lower right position Y	figAr- ea0_fig0_box_Y1	Set/Get	-99,999 to 99,999
90,099	figure0 Update	figArea0_update	Set only	1: Update

*1. RS-422 is unavailable in the FH/FHV series.

2-34 Circle Angle

This processing item can not be used in the FHV series.

Used in the Following Case

To correct the tilting of circle measurement objects:

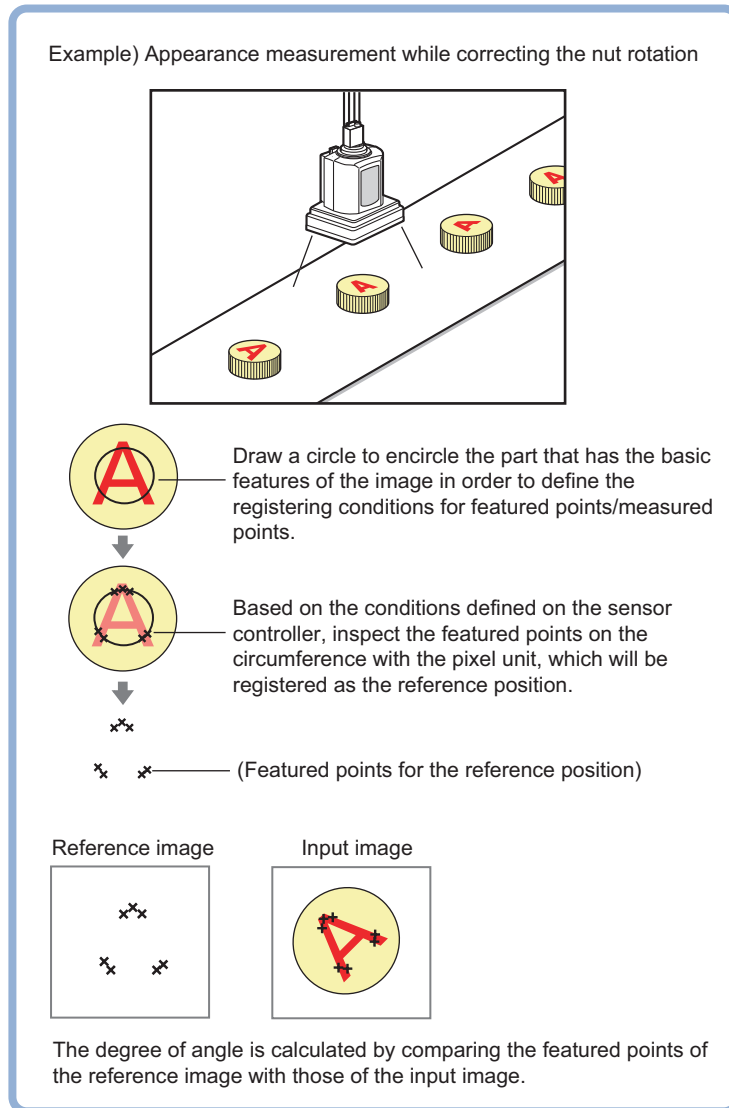

Precautions for Correct Use

Processing is different for color images and monochrome images. When the camera type used in the previous setup was changed to color or monochrome type, perform the settings again.



Additional Information

The center position of the measured object should be always fixed in order to efficiently use the Circle Angle. Prior to Circle Angle, processing items related to position correction should be performed, making the central coordinates of the measurement object stay at a fixed position. Example:

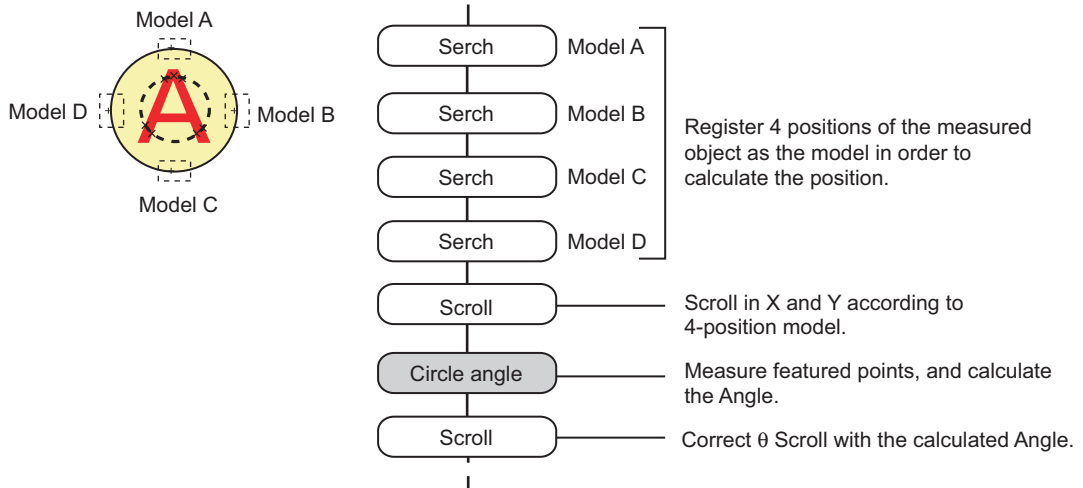

2-34 Circle Angle

2

2-34-1 Settings Flow (Circle Angle)

2-34-1 Settings Flow (Circle Angle)

To set Circle Angle, follow the steps below.

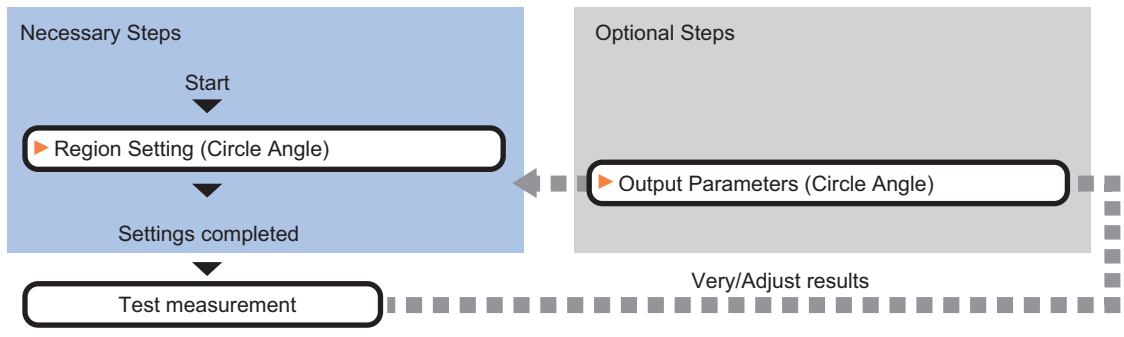

List of Circle Angle Items

Item	Description
Region setting	Sets the measurement area. It is possible to target the entire screen, but restricting the range can shorten the processing time. Measurement parameter can be changed as needed to address unstable measurement results. <i>2-34-2 Region Setting (Circle Angle)</i> on page 2-548
Output parameter	This item can be changed as necessary. Normally, the factory default value will be used. Use the output parameter to specify how to handle the coordinates. <i>2-34-3 Output Parameters (Circle Angle)</i> on page 2-550

2-34-2 Region Setting (Circle Angle)

This item is used to set up the measurement area. This item specifies the measurement region for **CircleAngle** with a circle. Ellipses cannot be set. If measurement results are unstable, change detection conditions as needed.





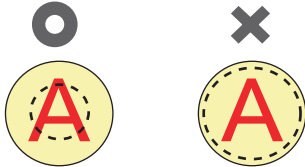

Additional Information

When the measurement region is drawn, the featured part should lie on the circumference.

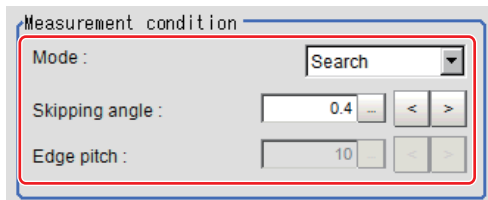

- 1** In the Item tab area, click **Region setting**.
- 2** Use the drawing tools to set the measurement region.
- 3** Click **OK** in the *Figure setting* area.
 - **OK**: Changes the settings and returns to the previous menu.
 - **Cancel**: Changes are discarded. Returns to the previous menu.
 - **Apply**: Updates the settings without leaving edit window.
- 4** If necessary, set a value for each item in the *Measurement condition* area.
After changing a setting, check whether measurement can be done properly by performing an actual measurement.

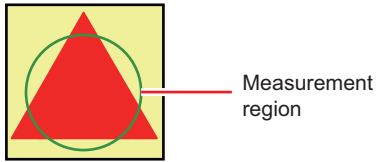

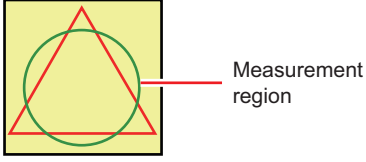
Setting item	Setting value [Factory default]	Description
Mode	<ul style="list-style-type: none"> • [Search] • Edge • Defect 	<ul style="list-style-type: none"> • Search: This option compares the color difference with the surrounding pixels and determines the angle based on the color information. • Edge: The angle is determined based on the position of the points with a large color difference from the neighboring pixels. *1 This mode is suitable for the following types of measurement objects.   <ul style="list-style-type: none"> • Defect: The angle is determined based on the position of the points with a large color difference from the surrounding pixels. *1 This mode is suitable for the following types of measurement objects.  

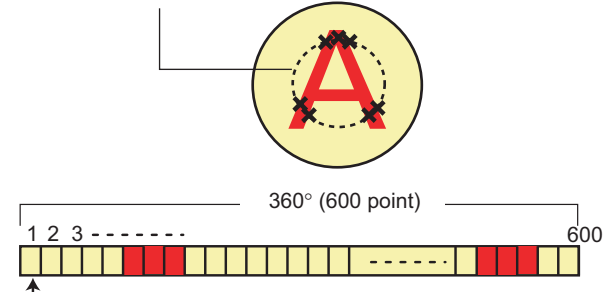
Setting item	Setting value [Factory default]	Description
Skipping angle	0.1 to 10 [0.4]	<p>Specify the interval degrees for extracting points. The color of all the points on the circumference (360° circumference/ skipping angle) corresponding to the set <i>Skipping angle</i>.</p> <p>Example) When the scale unit is 0.6° Measure 600 point on this line in the pixel unit.</p>  <p>360° (600 point)</p> <p>1 2 3 ----- 600</p> <p>↑ Calculate the color for every other point.</p> <p>For the initial setting, the optimal value will be automatically set up based on the radius of the drawn circle. The bigger the value set, the faster the processing, but the lower the detection angle and rotation precision.</p>
Edge pitch	1 to 99 [10]	<p>Specify the spacing for calculating the color difference. This item is enabled only when <i>Mode</i> is set to <i>Edge</i> or <i>Defect</i>.</p>

*1. Comparison is with the pixel separated by exactly the comparison interval (the value set in *Edge Pitch*).

2-34-3 Output Parameters (Circle Angle)

Specify how to treat the coordinates to be output to the external device as measurement results. This item can be changed if necessary. Normally, the factory default value will be used.



Precautions for Correct Use

After setting up the measurement parameters, changing the output parameters will cause measurement results to vary accordingly. If the output parameters have been changed, re-specify the measurement, too.

- 1** Click **Output parameter** in the Item Tab area.
- 2** Specify a value for each item.

Setting item	Setting value [Factory default]	Description
Output coordinates	<ul style="list-style-type: none"> • [After scroll] • Before scroll 	As measurement results, select whether to output coordinate values to external devices before or after the position deflection correction is applied.

Setting item	Setting value [Factory default]	Description
Calibration	<ul style="list-style-type: none"> • ON • [OFF] 	Select whether to reflect the calibration in the values output to the external device as measurement results. <ul style="list-style-type: none"> • ON: Output the coordinates converted into actual dimensions. • OFF: Output the camera coordinate values.

2-34-4 Key Points for Test Measurement and Adjustment (Circle Angle)

The following content is displayed in the *Detail result* area as text.

Displayed item	Description
Judge	Judgment results 0: No judgment (unmeasured) 1: Judgment result OK -1: Judgment result NG -10: Error (image format mismatch) -11: Error (unregistered model) -12: Error (insufficient memory) -20: Error (other errors)
Rotation angle	Measured Angle
Center position X	Center position X of circle in measurement results
Center position Y	Center position Y of circle in measurement results
Ref. angle	Angle of the circle drawn as the measurement region
Ref. coordinate X	Reference position X of the circle drawn as the measurement region
Ref. coordinate Y	Reference position Y of the circle drawn as the measurement region

Key Points for Adjustment (Circle Angle)

Adjust the setting parameters referring to the following points.

● When the measurement results are unstable

Parameter to be adjusted	Remedy
Region setting	Specify a smaller value for the <i>Skipping angle</i> .
Measurement flow	When the center position of measurement objects is not fixed, add position compensation to the flow so that the central coordinates of the measurement objects give a fixed position.

● When the processing speed is slow

Parameter to be adjusted	Remedy
Region setting	Specify a larger value for the <i>Skipping angle</i>
	Set the <i>Mode</i> to <i>Edge</i> or <i>Defect</i> .

2-34-5 Measurement Results for Which Output Is Possible (Circle Angle)

The following values can be output using processing items related to result output. It is also possible to reference measurement values from calculation expressions and other processing units.

Measurement items	Character string	Description
Judge	JG	Judgment results 0: No judgment (unmeasured) 1: Judgment result OK -1: Judgment result NG -10: Error (image format mismatch) -11: Error (unregistered model) -12: Error (insufficient memory) -20: Error (other errors)
Center position X	X	Center position X of circle in measurement results
Center position Y	Y	Center position Y of circle in measurement results
Rotation angle	TH	Angle of measurement results Output range -180° to 180°
Ref. coordinate X	SX	Reference position X of the circle drawn as the measurement region X ^{*1}
Ref. coordinate Y	SY	Reference Y of the circle drawn as the measurement region Y ^{*1}
Ref. angle	ST	Angle drawn as the measurement region

*1. Since measuring is performed at the same position every time for Circle Angle, "Center X = Reference SX, Center Y = Reference SY".

2-34-6 External Reference Tables (Circle Angle)

No.	Data name	Data ident	Set/Get	Data range
0	Judge	judge	Get only	0: No judgment (unmeasured), 1: Judgment result OK, -1: Judgment result NG, -10: Error (image format mismatch), -11: Error (unregistered model), -12: Error (insufficient memory), -20: Error (other errors)
5	Center position X	centerX	Get only	-99,999.9999 to 99,999.9999
6	Center position Y	centerY	Get only	-99,999.9999 to 99,999.9999
7	Rotation angle	angle	Get only	-180 to 180
8	Reference X	referenceX	Get only	-99,999.9999 to 99,999.9999
9	Reference Y	referenceY	Get only	-99,999.9999 to 99,999.9999
10	Reference angle	referenceAngle	Get only	-180 to 180
101	Output coordinates	outputCoordinate	Set/Get	0: After scroll, 1: Before scroll
102	Calibration	calibration	Set/Get	0: OFF, 1: ON
120	Mode	mode	Set/Get	0: Search, 1: Edge, 2: Defect
121	Skipping angle	thinning	Set/Get	0.1 to 10
122	Edge pitch	edgePitch	Set/Get	1 to 99
6,002	Format	cameraColor	Set/Get	1: Monochrome camera 2: Color camera
90,000	figure0 Count	figArea0_count	Set/Get	0 to 1

No.	Data name	Data ident	Set/Get	Data range
90,001	figure0 Type	figArea0_fig0_type	Set/Get	32: Circle 64: Circumference
90,002	figure0 mode	figArea0_fig0_mode	Set/Get	0: OR
90,022	figure0 Circle Center Position X	figArea0_fig0_circle_X	Set/Get	-99,999 to 99,999
90,023	figure0 Circle Center Position Y	figArea0_fig0_circle_Y	Set/Get	-99,999 to 99,999
90,024	figure0 Circle Radius	figArea0_fig0_circle_R	Set/Get	1 to 99,999
90,025	figure0 Circumference Center Position X	figArea0_fig0_circleW_X	Set/Get	-99,999 to 99,999
90,026	figure0 Circumference Center Position Y	figArea0_fig0_circleW_Y	Set/Get	-99,999 to 99,999
90,027	figure0 Circumference Radius	figArea0_fig0_circleW_R	Set/Get	0 to 99,999
90,028	figure0 Circumference Width	figArea0_fig0_circleW_W	Set/Get	0 to 99,999
90,099	figure0 Update	figArea0_update	Set only	1: Update

2-35 Glue Bead Inspection

Inspect the coated condition of coating (sealer, etc.). You can inspect coating of a specified color for gaps or runoffs along the coating path. In addition to inspecting the above, you can also measure the maximum width, minimum width and average of coating.

Used in the Following Case

When you want to inspect coating for gaps and runoffs

When no gap exists

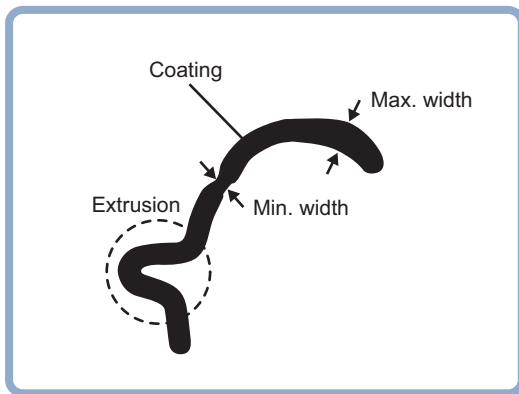

When gap exists

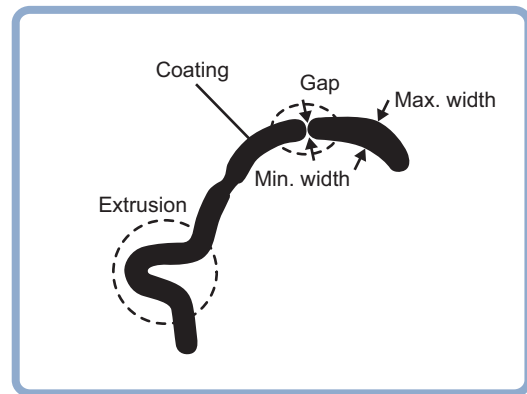

Precautions for Correct Use

Processing is different for color images and monochrome images. When the camera type used in the previous setup was changed to color or monochrome type, perform the settings again.

2-35-1 Settings Flow (Glue Bead Inspection)

To set Glue Bead Inspection, follow the steps below.

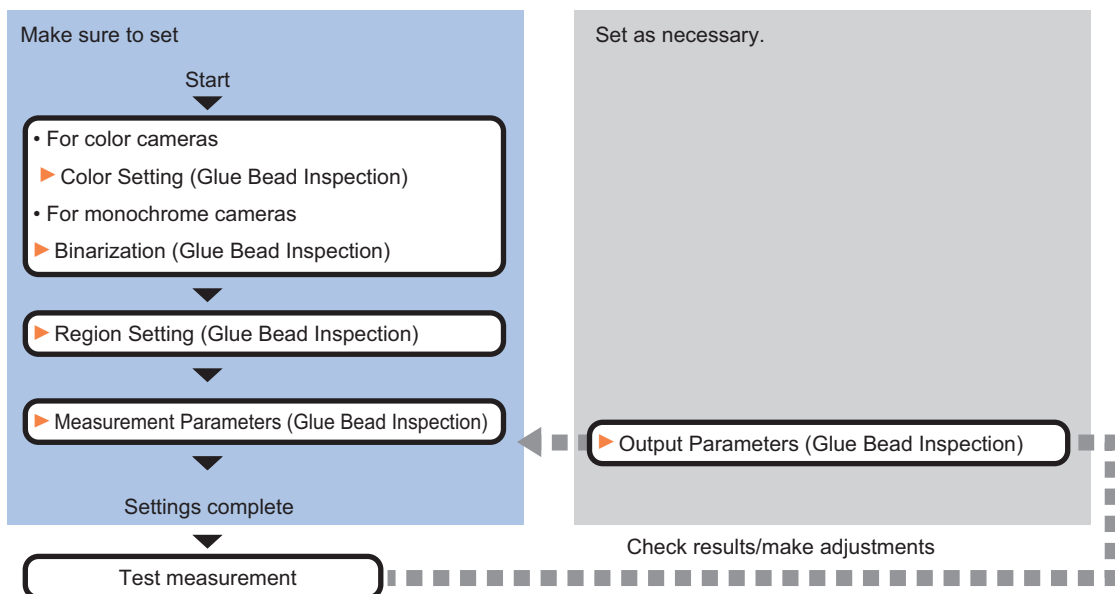

List of Glue Bead Inspection Items

Item	Description
Color (for color cameras only)	Sets the color of a coating to extract. <i>2-35-2 Color Specification (Glue Bead Inspection) on page 2-555</i>
Binary (for monochrome cameras only)	This item specifies the binary level for converting 256-tone grayscale images input from the camera into binary images. Converted white pixels are measured. Adjust the binary level so that the measurement object is converted to white pixels. <i>2-35-3 Binarization (Glue Bead Inspection) on page 2-557</i>
Region setting	Sets the measurement area. <i>2-35-4 Region Setting (Glue Bead Inspection) on page 2-558</i>
Measurement parameter	Sets the measurement and judgment conditions. <i>2-35-5 Measurement Parameters (Glue Bead Inspection) on page 2-561</i>
Output parameter	Selects whether or not to reflect the judgment result to the overall judgment of the scene. <i>2-35-6 Output Parameters (Glue Bead Inspection) on page 2-563</i>

2-35-2 Color Specification (Glue Bead Inspection)

When connecting a color camera, specify the color to be measured. There are two specification methods: specifying the color to be extracted in the image or specifying the color with the hue, saturation, and brightness values.

This section describes how to specify colors in an image and gives an example of the procedure for finely adjusting with numeric input afterwards.

- 1** In the Item Tab area, click **Color**.
- 2** Place a check at **Automatic**.
- 3** In the *Image Display* area, specify the color range you want to detect by dragging the cursor from the upper left corner to the lower right corner of that area.
The color of the specified area is automatically set.

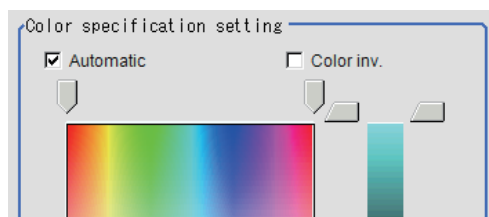

- 4** Finely adjust the hue, saturation, and brightness if necessary.
Adjust either by adjusting on the color chart or by inputting numbers.

Setting item	Setting value [Factory default]	Description
H	[0] to [359]	Sets the hue (difference in hue).
S	[0] to [255]	Sets the saturation (difference in saturation).
V	[0] to [255]	Sets the vividness (difference in vividness).

Setting item	Setting value [Factory default]	Description
Automatic	<ul style="list-style-type: none"> • Checked • [Unchecked] 	Specifies the color to be measured on the image automatically sets the <i>hue</i> , <i>saturation</i> , and <i>brightness</i> .
Color inv.	<ul style="list-style-type: none"> • Checked • [Unchecked] 	Color other than the color specified is the measurement target.

- About color charts:

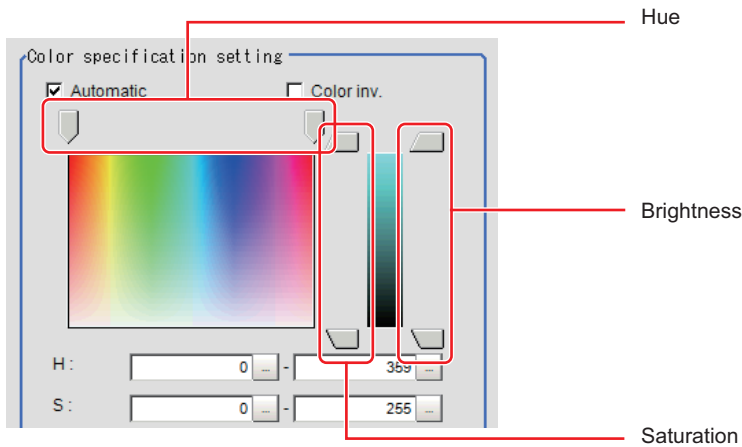

5 To specify multiple colors, place a check at **More ranges of color extraction**.

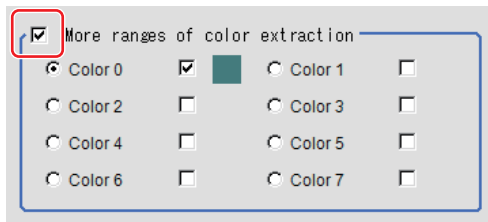

Setting item	Setting value [Factory default]	Description
More ranges of color extraction	<ul style="list-style-type: none"> • Checked • [Unchecked] 	Places a check at this allows you to set up to eight colors.

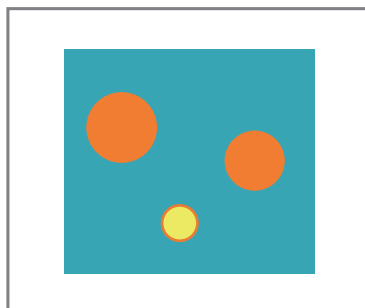

Extract image
(before specifying colors)

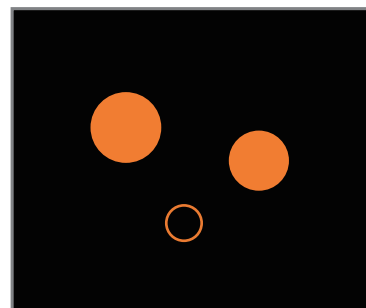

Extract image
(after specifying colors – background color: black)

6 If necessary, set the display conditions for displayed images.

Setting item	Setting value [Factory default]	Description
Exclude this color	<ul style="list-style-type: none"> • Checked • [Unchecked] 	Places a check at this one excludes pixels within the set HSV range from color extraction. The priority order for the extraction is that the higher color extraction range numbers are given priority. This setting is disabled when <i>More ranges of color extraction</i> is unchecked.
Background color	<ul style="list-style-type: none"> • [Black] • White • Red • Green • Blue 	The background part other than the extraction image is filled with the specified colors.
Type of image	<ul style="list-style-type: none"> • Measurement image • [All color image] • color selected image • Binary image 	Sets the state of the image to display.

2-35-3 Binarization (Glue Bead Inspection)

When a monochrome camera is connected, the 256-tone grayscale images taken in from the camera are converted into binary black-and-white images before the images are measured. Converted white pixels are measured.

This specifies the level for converting grayscale images into binary images.

- 1 In the Item Tab area, click **Binary**.
- 2 In the *Binary setting* area, specify the reference density range.

Setting item	Setting value [Factory default]	Description
Binary level	0 to 255 [128] to [255]	Sets a level to convert 256-gradation images to binary images. Set <i>Binary level</i> so that the measurement object becomes white pixels. A binary level for which measurement target is only middle density is also available.
Automatic	-	Optimum binary levels are calculated automatically and set.
Color inv.	<ul style="list-style-type: none"> • Checked • [Unchecked] 	Reverses black and white.

- 3** If necessary, in the *Display setting* area, set up display settings for the images displayed in the *Image Display* area.

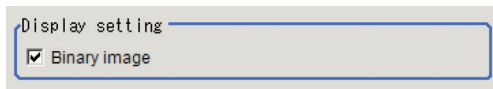

Setting item	Setting value [Factory default]	Description
Binary image	<ul style="list-style-type: none"> • [Checked] • Unchecked 	The image is displayed in binary with black and white.

2-35-4 Region Setting (Glue Bead Inspection)

Set the inspection region and extract the coating path. All you need is register three items--measurement region, start line and end line--and then click **Register route**, and a path will be extracted automatically.

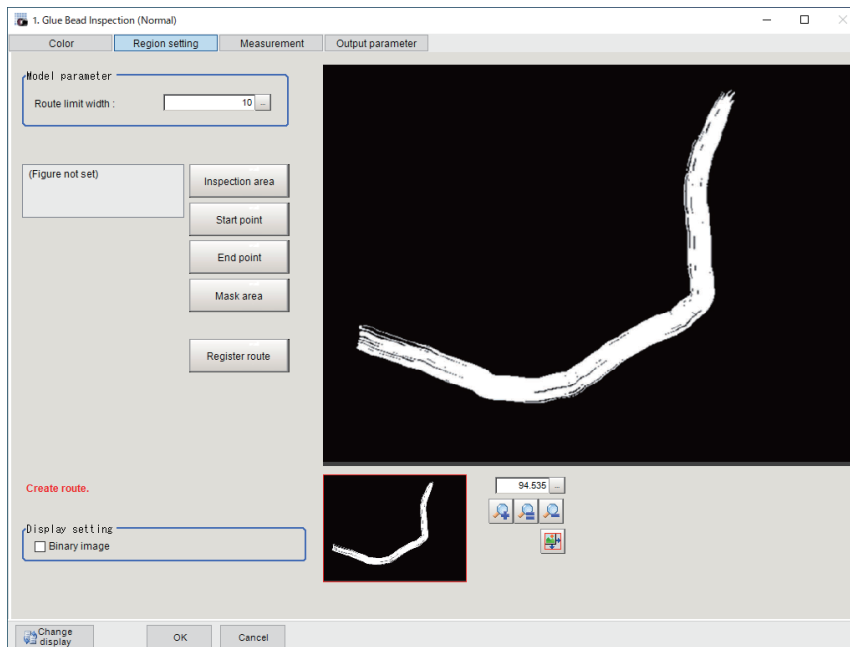

- 1** Click **Region setting** in the item tab area.
- 2** Click **Inspection area** and register the measurement region.



- 3** Register the start position of the region with **Start point** and the end position with **End point**. Register the positions so that they perpendicularly bisect the glueing.

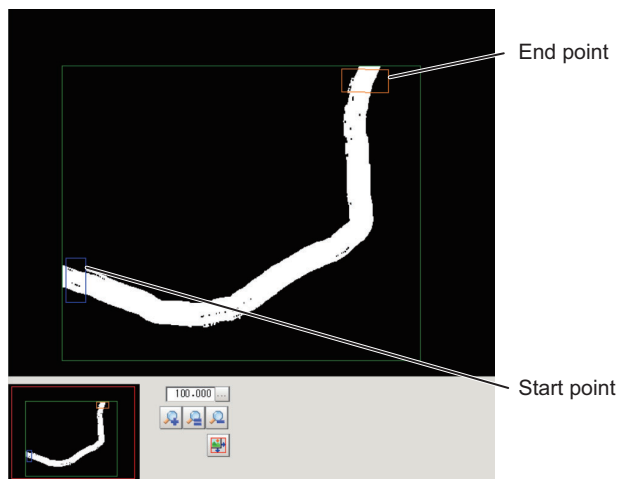

Precautions for Correct Use

- Make sure that no part protrudes from the measurement region.
- The maximum route length that can be detected is 50,000 pixels.
- If they diagonally bisect the glueing, the area will become the maximum width making it impossible to accurately measure the area.
- Set the distance between the start line and end line wider than expected glue break width. To inspect glue bead in made in round shape, register two Glue Bead Inspection processing items to perform inspection in two regions.

- 4** If necessary, use **Mask area** to register the mask region.
The measurement result of the width inspection in the mask area is ignored.

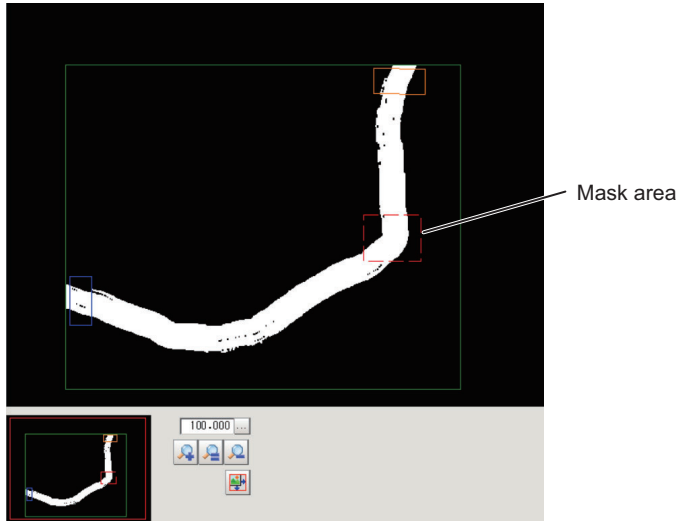

5 If necessary, set the following parameters in the *Model parameter* area.

Setting item	Setting value [Factory default]	Description
Route limit width	0 to 100 [10]	Specifies a glueing route width to be judged as "OK". When it exceeds the set area the inspection result will be "NG". The unit is pixel.

6 Click **Register route**.

Create an outline of the glueing.

Glueing outline (blue, mask region is pink): Calculates the width based on this outline information

Route limit width (dark red): The outline + route limit width outline areas are registered.

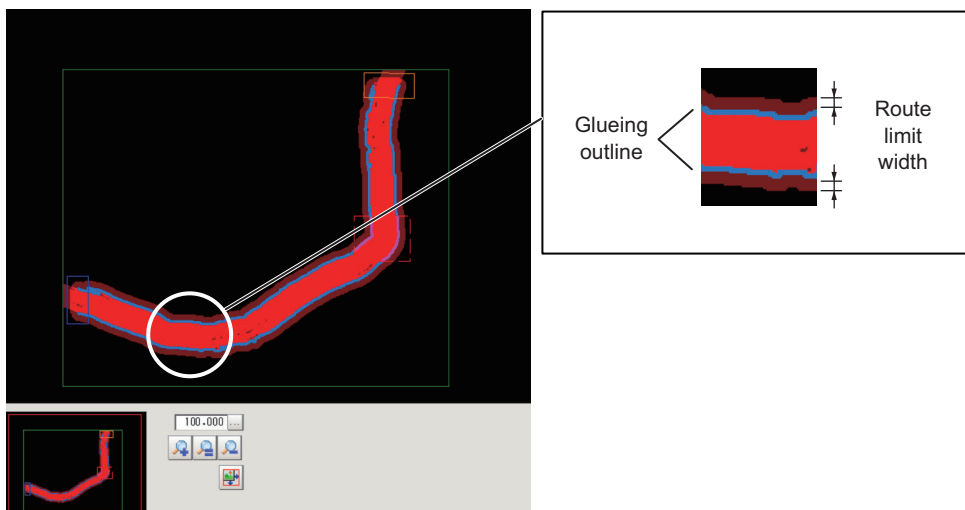

Additional Information

It is the longest route, even for circular coatings or multiple coatings.

If you want to use the shorter route, adjust the measurement region or set the NOT area in the **Inspection area**. With no other coating between the start and end lines, click **Register route**.

- 7 If necessary, set up display settings for the images in the *Display setting* area.

Setting item	Setting value [Factory default]	Description
Binary image	<ul style="list-style-type: none"> • [Checked] • Unchecked 	The image is displayed in binary with black and white.

2-35-5 Measurement Parameters (Glue Bead Inspection)

Set the inspection measurement conditions and the judgement conditions for the measurement results.

- 1 In the Item Tab area, click **Measurement**.
- 2 In the *Measurement condition* area, specify a value for each item.

Measurement condition

Inspection kind : Only width inspection





Noise cut : OFF ON

Labeling : OFF ON

Object area range : 100 - 99999999

Fill profile : None Fill profile Filling up holes

Setting item	Setting value [Factory default]	Description
Inspection kind	<ul style="list-style-type: none"> • [Only width inspection] • Only route inspection • Both inspection 	Selects the inspection type.
Noise reduction	<ul style="list-style-type: none"> • OFF • [ON] 	Sets whether or not to perform noise reduction. Set this option if fine pixel noises generate. Basically the processing should be set to <i>ON</i> to ensure stable measurement.
Labeling	<ul style="list-style-type: none"> • OFF • [ON] 	Selects whether or not to process noise removal using the labeling filter. Set this option if noises generate. You can use this processing to measure only the labels in the range set in "Object area range ". Basically the processing should be set to <i>ON</i> to ensure stable measurement.
Object area range	0 to 99,999,999 [100 to 99,999,999]	Sets the area range of labels to be measured.

Setting item	Setting value [Factory default]	Description
Fill profile	<ul style="list-style-type: none"> • [None] • Fill profile • Filling up holes 	<p>Selects the fill profile method.</p> <ul style="list-style-type: none"> • None The empty section in the center is not filled in. • Fill outline In the measurement region, the part between the extracted-color start point and end point in the X-axis direction is measured as having the extracted color. Since filling is applied only to the X-axis direction, the processing is faster than filling up holes. <div style="display: flex; justify-content: space-around; align-items: center;"> <div style="text-align: center;"> <p>Input image</p>  </div> <div style="text-align: center;"> <p>Image after filling up hole</p>  </div> </div> <ul style="list-style-type: none"> • Filling up holes The part surrounded by the extracted color, like a doughnut hole, is filled with the extracted color. <div style="display: flex; justify-content: space-around; align-items: center;"> <div style="text-align: center;"> <p>Input image</p>  </div> <div style="text-align: center;"> <p>Fill profile image</p>  </div> </div>

3 In the *Display setting* area, set the image display settings.

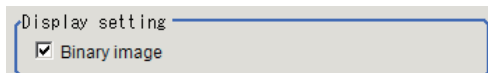

Setting item	Setting value [Factory default]	Description
Binary image	<ul style="list-style-type: none"> • [Checked] • Unchecked 	The image is displayed in binary with black and white.

4 When the setting has been changed, click **Measure** in the *Detail* area to verify whether measurements can be made correctly.

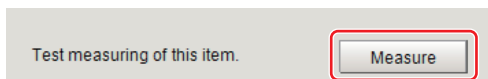

5 Set up the judgment condition.

The values beside each item are measurement results of the displayed image. Take these values into consideration to determine the upper and lower limit values.

Setting item	Setting value	Description
Route len. (Long)	0.0000 to 99,999.9999	Sets the range of path lengths (long) that is judged to be OK.
Route len. (Short)	0.0000 to 99,999.9999	Sets the range of path lengths (short) that is judged to be OK.

Setting item	Setting value	Description
Min. width	0.0000 to 99,999.9999	Sets the minimum width that is judged to be OK.
Max. width	0.0000 to 99,999.9999	Sets the maximum width that is judged to be OK.
Ave. width	0.0000 to 99,999.9999	Sets the average width that is judged to be OK.
Gap width	0.0000 to 99,999.9999	Sets the gap width along a path that are judged to be OK.



Additional Information

- The longer the contour of the coating is the path lengths (long), and the shorter the contour of the coating is the path lengths (short).
If the coating is applied in a straight line, the path lengths (long) and the path lengths (short) will be the same value.
If the coating is bent, the path lengths (long) and the path lengths (short) will be different values. For example, in the case of a coating in the shape of "C", the inner path has a path lengths (short) and the outer path has a path lengths (long).

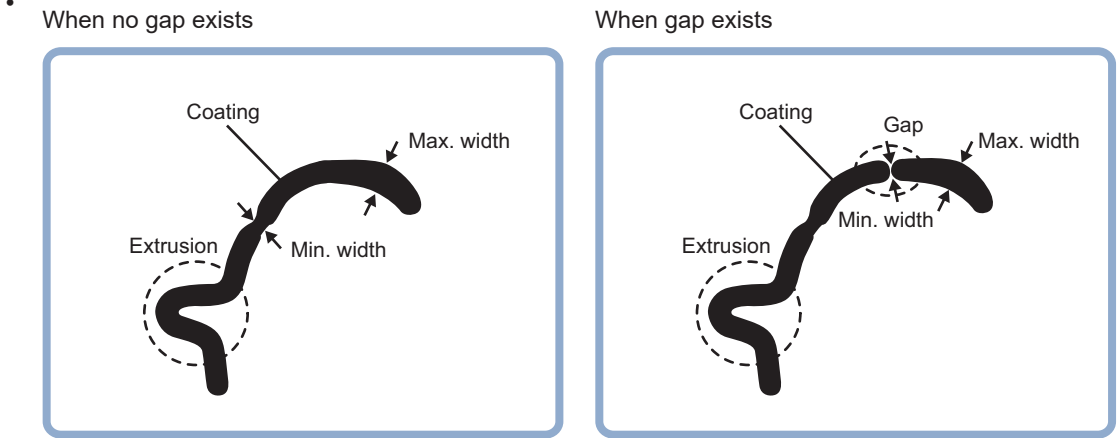

2-35-6 Output Parameters (Glue Bead Inspection)

Specify how to treat the coordinates to be output to the external device as measurement results. This item can be changed if necessary. Normally, the factory default value will be used.



Precautions for Correct Use

After setting up the measurement parameters, changing the output parameters will cause measurement results to vary accordingly. If the output parameters have been changed, re-specify the measurement, too.

1 Click **Output parameter** in the Item tab area.

2 Specify each of the following items.

Setting item	Setting value [Factory default]	Description
Output coordinates	<ul style="list-style-type: none"> [After scroll] Before scroll 	As measurement results, select whether to output coordinate values to external devices before or after the position deflection correction is applied.

Setting item	Setting value [Factory default]	Description
Calibration	<ul style="list-style-type: none"> • ON • [OFF] 	Select whether to reflect the calibration in the values output to the external device as measurement results. <ul style="list-style-type: none"> • ON: Output the coordinates converted into actual dimensions. • OFF: Output the camera coordinate values.
Reflect to overall judgment	<ul style="list-style-type: none"> • [ON] • OFF 	Enables choosing whether or not the judgement results of this processing unit is reflected in the scene overall judgment.



Additional Information

For output coordinates and calibration, refer to *Appendixes Measurement Mechanism Handling Coordinates* in the *Vision System FH/FHV Series User's Manual (Cat. No. Z365)*.

2-35-7 Key Points for Test Measurement and Adjustment (Glue Bead Inspection)

The following content is displayed in the *Detail result* area as text.

Displayed item	Description
Judge	Judgment results 0: No judgment (unmeasured) 1: Judgment result OK -1: Judgment result NG -10: Error (image format mismatch) -11: Error (unregistered model) -12: Error (insufficient memory) -20: Error (other errors)
State	Coated condition of measured coating
Min. width	Maximum width of measured coating
Max. width	Minimum width of measured coating
Gap width	Gap width of measured coating

Key Points for Adjustment (Glue Bead Inspection)

Adjust the setting parameters referring to the following points.

● When a path creation error occurs

Parameter to be adjusted	Remedy
Region setting	When either the start position or end position is set outside the measurement region, set the start position or end position to the inside of the measurement region.
	When either the start position or end position is yet to be registered, set the start position or end position, whichever is applicable.
	When either the start position or end position is inappropriate to fully enclose coating, register the start position or end position so that the two positions are vertically set across coating.
	When the coating has been plurally separated between the start and end positions, register multiple coating gap inspections and set separate inspection parts.
	When width between paths of a spiral path is sometimes measured, divide the spiral into regions corresponding to individual turns and set a unit for each region.

● When judgement is NG

Parameter to be adjusted	Remedy
Region setting	When the judgement is NG (insufficient memory), adjust the region so that the reference path becomes shorter.

2-35-8 Measurement Results for Which Output is Possible (Glue Bead Inspection)

The following values can be output using processing items related to result output. It is also possible to reference measurement values from calculation expressions and other processing units.

Measurement items	Character string	Description
Judge	JG	1: OK 0: Unmeasured -1: NG
State	ST	State of measured results 0: Detectable 1: Gapped 2: Path error -1: Unmeasured -2: Region not yet registered -3: Coating not yet detected -4: Excessive path (insufficient memory)
Min. width	MINWD	Min. width
Max. width	MAXWD	Max. width
Average width	AVGWD	Average width
Gap width	GAPWD	Gap width
Coordinate X1 of minimum width	MINX1	X coordinate X 1 of the minimum width
Coordinate Y1 of minimum width	MINY1	Y Coordinate Y1 of the minimum width
Coordinate X2 of minimum width	MINX2	X coordinate X2 of the minimum width

Measurement items	Character string	Description
Coordinate Y2 of minimum width	MINY2	Y coordinate Y2 of the minimum width
Coordinate X1 of maximum width	MAXX1	X coordinate X 1 of the maximum width
Coordinate Y1 of maximum width	MAXY1	Y coordinate Y1 of the maximum width
Coordinate X2 of maximum width	MAXX2	X coordinate X2 of the maximum width
Coordinate Y2 of maximum width	MAXY2	Y coordinate Y2 of the maximum width
Coordinate X1 of gap width	GAPX1	X coordinate X1 of gap width
Coordinate Y1 of gap width	GAPY1	Y coordinate Y1 of gap width
Coordinate X2 of gap width	GAPX2	X coordinate X2 of gap width
Coordinate Y2 of gap width	GAPY2	Y coordinate Y2 of gap width

2-35-9 External Reference Tables (Glue Bead Inspection)

No.	Data name	Data ident	Set/Get	Data range
0	Judge	judge	Get only	0: No judgment (unmeasured), 1: Judgment result OK, -1: Judgment result NG, -10: Error (image format mismatch), -11: Error (unregistered model), -12: Error (insufficient memory), -20: Error (other errors)
5	Status	state	Get only	-
6	Min. width	minWidth	Get only	-
7	Max. width	maxWidth	Get only	-
8	Avg. width	aveWidth	Get only	-
9	Gap width	lackWidth	Get only	-
10	Route len. (Long)	lenLong	Get only	-
11	Route len. (Short)	lenShort	Get only	-
101	Output coordinates	outputCoordinate	Set/Get	0: After scroll, 1: Before scroll
102	Calibration	calibration	Set/Get	0: OFF, 1: ON
103	Reflect to overall judgement	overallJudge	Set/Get	0: ON, 1: OFF
128	Fill profile	edgeFill	Set/Get	0: OFF, 1: Fill profile, 2: Filling up holes
129	Color inv.	arealnv	Set/Get	0: OFF, 1: ON
130	Noise cut	noiseCut	Set/Get	0: OFF, 1: ON
131	Route limit width	maskWidth	Set/Get	2 to 100
132	Upper limit of the Min.width	upperMinWidth	Set/Get	0 to 99,999.9999
133	Lower limit of the Min.width	lowerMinWidth	Set/Get	0 to 99,999.9999
134	Upper limit of the Max. width	upperMaxWidth	Set/Get	0 to 99,999.9999
135	Lower limit of the Max. width	lowerMaxWidth	Set/Get	0 to 99,999.9999
136	Upper limit of the average width	upperAveWidth	Set/Get	0 to 99,999.9999

No.	Data name	Data ident	Set/Get	Data range
137	Lower limit of the average width	lowerAveWidth	Set/Get	0 to 99,999.9999
138	Upper limit of the Gap width	upperLackWidth	Set/Get	0 to 99,999.9999
139	Lower limit of the Gap width	lowerLackWidth	Set/Get	0 to 99,999.9999
142	Upper limit of the area	upperBinary	Set/Get	0 to 255
143	Lower limit of the area	lowerBinary	Set/Get	0 to 255
144	Binary image	binaryImage	Set/Get	0: OFF, 1: ON
145	Scan line 0	counterClockwise0	Set/Get	0: Clockwise 1: AntiClockwise
146	Scan line 1	counterClockwise1	Set/Get	0: Clockwise 1: AntiClockwise
147	Upper limit of the Route len. (Long)	upperLenLong	Set/Get	0 to 99,999.9999
148	Lower limit of the Route len. (Long)	lowerLenLong	Set/Get	0 to 99,999.9999
149	Upper limit of the Route len. (Short)	upperLenShort	Set/Get	0 to 99,999.9999
150	Lower limit of the Route len. (Short)	lowerLenShort	Set/Get	0 to 99,999.9999
151	Multiple selections	multiSelect	Set/Get	0: Multiselect NG 1: MultiSelect OK
152	Image kind	imageKind	Set/Get	0: Measurement image, 1: All color image, 2: Selection color image, 3: Binary image
153	Upper limit of Object area range	upperFillLabelArea	Set/Get	0 to 999,999,999
154	Lower limit of Object area range	lowerFillLabelArea	Set/Get	0 to 999,999,999
155	Labeling	labelingOnOff	Set/Get	0: OFF, 1: ON
156	Inspection kind	inspectionKind	Set/Get	0: Width's inspection only, 1: Route's inspection only, 2: Width and route's inspection
160+N×10 (N=0 to 7)	Flag N used for registered color	flag0 to flag7	Set/Get	0: OFF, 1: ON
161+N×10 (N=0 to 7)	Flag N for registered color OR/NOT	orNot0 to orNot7	Set/Get	0:OR 1:NOT
162+N×10 (N=0 to 7)	Register the max. color hue	upperH0 to upperH7	Set/Get	0 to 359
163+N×10 (N=0 to 7)	Register the min. color hue	lowerH0 to lowerH7	Set/Get	0 to 359
164+N×10 (N=0 to 7)	Register the max. color saturation	upperS0 to upperS7	Set/Get	0 to 255
165+N×10 (N=0 to 7)	Register the min. color saturation	lowerS0 to lowerS7	Set/Get	0 to 255
166+N×10 (N=0 to 7)	Register the max. color brightness	upperV0 to upperV7	Set/Get	0 to 255

No.	Data name	Data ident	Set/Get	Data range
167+N×10 (N=0 to 7)	Register the min. color brightness	lowerV0 to lowerV7	Set/Get	0 to 255
168+N×10 (N=0 to 7)	Background color	background0 to background7	Set/Get	0: Black, 1: White, 2: Red, 3: Green, 4: Blue
1,000+N×2 (N=0 to 1)	Min.width X	minX0 to minX1	Get only	-
1,001+N×2 (N=0 to 1)	Min.width Y	minY0 to minY1	Get only	-
1,004+N×2 (N=0 to 1)	Max.width X	maxX0 to maxX1	Get only	-
1,005+N×2 (N=0 to 1)	Max.width Y	maxY0 to maxY1	Get only	-
1,008+N×2 (N=0 to 1)	Gap pos. X	lackX0 to lackX1	Get only	-
1,009+N×2 (N=0 to 1)	Gap pos. Y	lackY0 to lackY1	Get only	-
6,002	Format	cameraColor	Set/Get	1: Monochrome camera 2: Color camera
90,000	Inspection area figure Count	figArea0_count	Set/Get	0 to 10
90,001	Inspection area figure0 Type	figArea0_fig0_type	Set/Get	4: Wide line, 8: Rectangle, 16: Ellipse, 64: Circumference, 256: Wide arc, 512: Polygon
90,002	Inspection area figure0 mode	figArea0_fig0_mode	Set/Get	0: OR, 1: NOT
90,009	Inspection area figure0 Wide line Start point X	figArea0_fig0_lineW_X0	Set/Get	-99,999 to 99,999
90,010	Inspection area figure0 Wide line Start point Y	figArea0_fig0_lineW_Y0	Set/Get	-99,999 to 99,999
90,011	Inspection area figure0 Wide line End point X	figArea0_fig0_lineW_X1	Set/Get	-99,999 to 99,999
90,012	Inspection area figure0 Wide line End point Y	figArea0_fig0_lineW_Y1	Set/Get	-99,999 to 99,999
90,013	Inspection area figure0 Wide line Width	figArea0_fig0_lineW_W	Set/Get	0 to 99,999
90,014	Inspection area figure0 Rectangle Upper left position X	figArea0_fig0_box_X0	Set/Get	-99,999 to 99,999
90,015	Inspection area figure0 Rectangle Upper left position Y	figArea0_fig0_box_Y0	Set/Get	-99,999 to 99,999
90,016	Inspection area figure0 Rectangle Lower right position X	figArea0_fig0_box_X1	Set/Get	-99,999 to 99,999

No.	Data name	Data ident	Set/Get	Data range
90,017	Inspection area figure0 Rectangle Lower right position Y	figArea0_fig0_box_Y1	Set/Get	-99,999 to 99,999
90,018	Inspection area figure0 Ellipse Center Position X	figArea0_fig0_ellipse_CX	Set/Get	-99,999 to 99,999
90,019	Inspection area figure0 Ellipse Center Position Y	figArea0_fig0_ellipse_CY	Set/Get	-99,999 to 99,999
90,020	Inspection area figure0 Ellipse RadiusX	figArea0_fig0_ellipse_RX	Set/Get	1 to 99,999
90,021	Inspection area figure0 Ellipse RadiusY	figArea0_fig0_ellipse_RY	Set/Get	1 to 99,999
90,025	Inspection area figure0 Circumference Center Position X	figArea0_fig0_circleW_X	Set/Get	-99,999 to 99,999
90,026	Inspection area figure0 Circumference Center Position Y	figArea0_fig0_circleW_Y	Set/Get	-99,999 to 99,999
90,027	Inspection area figure0 Circumference Radius	figArea0_fig0_circleW_R	Set/Get	0 to 99,999
90,028	Inspection area figure0 Circumference Width	figArea0_fig0_circleW_W	Set/Get	0 to 99,999
90,034	Inspection area figure0 Wide arc Center Position X	figArea0_fig0_arcW_X	Set/Get	-99,999 to 99,999
90,035	Inspection area figure0 Wide arc Center Position Y	figArea0_fig0_arcW_Y	Set/Get	-99,999 to 99,999
90,036	Inspection area figure0 Wide arc Radius	figArea0_fig0_arcW_R	Set/Get	0 to 99,999
90,037	Inspection area figure0 Wide arc Start angle	figArea0_fig0_arcW_SA	Set/Get	-180 to 180
90,038	Inspection area figure0 Wide arc End angle	figArea0_fig0_arcW_EA	Set/Get	-180 to 180
90,039	Inspection area figure0 Wide arc Width	figArea0_fig0_arcW_W	Set/Get	0 to 99,999
90,040	Inspection area figure0 Polygon Point Count	figArea0_fig0_polygon_count	Set/Get	3 to 10
90,041	Inspection area figure0 Polygon Point1 Position X	figArea0_fig0_polygon_x0	Set/Get	-99,999 to 99,999
90,042	Inspection area figure0 Polygon Point1 Position Y	figArea0_fig0_polygon_y0	Set/Get	-99,999 to 99,999

No.	Data name	Data ident	Set/Get	Data range
:	:	:	:	:
90,059	Inspection area figure0 Polygon Point10 Position X	figArea0_fig0_polygon_x9	Set/Get	-99,999 to 99,999
90,060	Inspection area figure0 Polygon Point10 Position Y	figArea0_fig0_polygon_y9	Set/Get	-99,999 to 99,999
90,099	Inspection area figure Update	figArea0_update	Set only	1:Update
90,101	Inspection area figure1 Type	figArea0_fig1_type	Set/Get	4: Wide line, 8: Rectangle, 16: Ellipse, 64: Circumference, 256: Wide arc, 512: Polygon
:	:	:	:	:
90,201	Inspection area figure2 Type	figArea0_fig2_type	Set/Get	4: Wide line, 8: Rectangle, 16: Ellipse, 64: Circumference, 256: Wide arc, 512: Polygon
:	:	:	:	:
90,301	Inspection area figure3 Type	figArea0_fig3_type	Set/Get	4: Wide line, 8: Rectangle, 16: Ellipse, 64: Circumference, 256: Wide arc, 512: Polygon
:	:	:	:	:
90,401	Inspection area figure4 Type	figArea0_fig4_type	Set/Get	4: Wide line, 8: Rectangle, 16: Ellipse, 64: Circumference, 256: Wide arc, 512: Polygon
:	:	:	:	:
90,501	Inspection area figure5 Type	figArea0_fig5_type	Set/Get	4: Wide line, 8: Rectangle, 16: Ellipse, 64: Circumference, 256: Wide arc, 512: Polygon
:	:	:	:	:
90,601	Inspection area figure6 Type	figArea0_fig6_type	Set/Get	4: Wide line, 8: Rectangle, 16: Ellipse, 64: Circumference, 256: Wide arc, 512: Polygon
:	:	:	:	:
90,701	Inspection area figure7 Type	figArea0_fig7_type	Set/Get	4: Wide line, 8: Rectangle, 16: Ellipse, 64: Circumference, 256: Wide arc, 512: Polygon
:	:	:	:	:
90,801	Inspection area figure8 Type	figArea0_fig8_type	Set/Get	4: Wide line, 8: Rectangle, 16: Ellipse, 64: Circumference, 256: Wide arc, 512: Polygon
:	:	:	:	:

No.	Data name	Data ident	Set/Get	Data range
90,901	Inspection area figure9 Type	figArea0_fig9_type	Set/Get	4: Wide line, 8: Rectangle, 16: Ellipse, 64: Circumference, 256: Wide arc, 512: Polygon
:	:	:	:	:
91,000	Start point figure Count	figArea1_count	Set/Get	0 to 1
91,001	Start point figure0 Type	figArea1_fig0_type	Set/Get	4: Wide line
91,002	Start point figure0 mode	figArea1_fig0_mode	Set/Get	0: OR
91,009	Start point figure0 Wide line Start point X	figArea1_fig0_lineW_X0	Set/Get	-99,999 to 99,999
91,010	Start point figure0 Wide line Start point Y	figArea1_fig0_lineW_Y0	Set/Get	-99,999 to 99,999
91,011	Start point figure0 Wide line End point X	figArea1_fig0_lineW_X1	Set/Get	-99,999 to 99,999
91,012	Start point figure0 Wide line End point Y	figArea1_fig0_lineW_Y1	Set/Get	-99,999 to 99,999
91,013	Start point figure0 Wide line Width	figArea1_fig0_lineW_W	Set/Get	0 to 99,999
91,099	Start point figure Update	figArea1_update	Set only	1: Update
92,000	Mask area figure Count	figArea2_count	Set/Get	0 to 10
92,001	Mask area figure0 Type	figArea2_fig0_type	Set/Get	4: Wide line, 8: Rectangle, 16: Ellipse, 64: Circumference, 256: Wide arc, 512: Polygon
92,002	Mask area figure0 mode	figArea2_fig0_mode	Set/Get	0: OR, 1: NOT
92,009	Mask area figure0 Wide line Start point X	figArea2_fig0_lineW_X0	Set/Get	-99,999 to 99,999
92,010	Mask area figure0 Wide line Start point Y	figArea2_fig0_lineW_Y0	Set/Get	-99,999 to 99,999
92,011	Mask area figure0 Wide line End point X	figArea2_fig0_lineW_X1	Set/Get	-99,999 to 99,999
92,012	Mask area figure0 Wide line End point Y	figArea2_fig0_lineW_Y1	Set/Get	-99,999 to 99,999
92,013	Mask area figure0 Wide line Width	figArea2_fig0_lineW_W	Set/Get	0 to 99,999

No.	Data name	Data ident	Set/Get	Data range
92,014	Mask area figure0 Rectangle Upper left position X	figAr- ea2_fig0_box_X0	Set/Get	-99,999 to 99,999
92,015	Mask area figure0 Rectangle Upper left position Y	figAr- ea2_fig0_box_Y0	Set/Get	-99,999 to 99,999
92,016	Mask area figure0 Rectangle Lower right position X	figAr- ea2_fig0_box_X1	Set/Get	-99,999 to 99,999
92,017	Mask area figure0 Rectangle Lower right position Y	figAr- ea2_fig0_box_Y1	Set/Get	-99,999 to 99,999
92,018	Mask area figure0 Ellipse Center Posi- tion X	figArea2_fig0_el- lipse_CX	Set/Get	-99,999 to 99,999
92,019	Mask area figure0 Ellipse Center Posi- tion Y	figArea2_fig0_el- lipse_CY	Set/Get	-99,999 to 99,999
92,020	Mask area figure0 Ellipse RadiusX	figArea2_fig0_el- lipse_RX	Set/Get	1 to 99,999
92,021	Mask area figure0 Ellipse RadiusY	figArea2_fig0_el- lipse_RY	Set/Get	1 to 99,999
92,025	Mask area figure0 Circumference Cen- ter Position X	figArea2_fig0_cir- cleW_X	Set/Get	-99,999 to 99,999
92,026	Mask area figure0 Circumference Cen- ter Position Y	figArea2_fig0_cir- cleW_Y	Set/Get	-99,999 to 99,999
92,027	Mask area figure0 Circumference Radi- us	figArea2_fig0_cir- cleW_R	Set/Get	0 to 99,999
92,028	Mask area figure0 Circumference Width	figArea2_fig0_cir- cleW_W	Set/Get	0 to 99,999
92,034	Mask area figure0 Wide arc Center Po- sition X	figAr- ea2_fig0_arcW_X	Set/Get	-99,999 to 99,999
92,035	Mask area figure0 Wide arc Center Po- sition Y	figAr- ea2_fig0_arcW_Y	Set/Get	-99,999 to 99,999
92,036	Mask area figure0 Wide arc Radius	figAr- ea2_fig0_arcW_R	Set/Get	0 to 99,999
92,037	Mask area figure0 Wide arc Start angle	figAr- ea2_fig0_arcW_SA	Set/Get	-180 to 180
92,038	Mask area figure0 Wide arc End angle	figAr- ea2_fig0_arcW_EA	Set/Get	-180 to 180
92,039	Mask area figure0 Wide arc Width	figAr- ea2_fig0_arcW_W	Set/Get	0 to 99,999
92,040	Mask area figure0 Polygon Point Count	figArea2_fig0_poly- gon_count	Set/Get	3 to 10

No.	Data name	Data ident	Set/Get	Data range
92,041	Mask area figure0 Polygon Point1 Position X	figArea2_fig0_polygon_x0	Set/Get	-99,999 to 99,999
92,042	Mask area figure0 Polygon Point1 Position Y	figArea2_fig0_polygon_y0	Set/Get	-99,999 to 99,999
:	:	:	:	:
92,057	Mask area figure0 Polygon Point9 Position X	figArea2_fig0_polygon_x8	Set/Get	-99,999 to 99,999
92,058	Mask area figure0 Polygon Point9 Position Y	figArea2_fig0_polygon_y8	Set/Get	-99,999 to 99,999
92,059	Mask area figure0 Polygon Point10 Position X	figArea2_fig0_polygon_x9	Set/Get	-99,999 to 99,999
92,060	Mask area figure0 Polygon Point10 Position Y	figArea2_fig0_polygon_y9	Set/Get	-99,999 to 99,999
92,099	Mask area figure Update	figArea2_update	Set only	1: Update
92,101	Mask area figure1 Type	figArea2_fig1_type	Set/Get	4: Wide line, 8: Rectangle, 16: Ellipse, 64: Circumference, 256: Wide arc, 512: Polygon
92,102	Mask area figure1 mode	figArea2_fig1_mode	Set/Get	0:OR 1:NOT
:	:	:	:	:
92,201	Mask area figure2 Type	figArea2_fig2_type	Set/Get	4: Wide line, 8: Rectangle, 16: Ellipse, 64: Circumference, 256: Wide arc, 512: Polygon
:	:	:	:	:
92,301	Mask area figure3 Type	figArea2_fig3_type	Set/Get	4: Wide line, 8: Rectangle, 16: Ellipse, 64: Circumference, 256: Wide arc, 512: Polygon
:	:	:	:	:
92,401	Mask area figure4 Type	figArea2_fig4_type	Set/Get	4: Wide line, 8: Rectangle, 16: Ellipse, 64: Circumference, 256: Wide arc, 512: Polygon
:	:	:	:	:
92,501	Mask area figure5 Type	figArea2_fig5_type	Set/Get	4: Wide line, 8: Rectangle, 16: Ellipse, 64: Circumference, 256: Wide arc, 512: Polygon
:	:	:	:	:

No.	Data name	Data ident	Set/Get	Data range
92,601	Mask area figure6 Type	figArea2_fig6_type	Set/Get	4: Wide line, 8: Rectangle, 16: Ellipse, 64: Circumfer- ence, 256: Wide arc, 512: Polygon
:	:	:	:	:
92,801	Mask area figure8 Type	figArea2_fig8_type	Set/Get	4: Wide line, 8: Rectangle, 16: Ellipse, 64: Circumfer- ence, 256: Wide arc, 512: Polygon
:	:	:	:	:
92,901	Mask area figure9 Type	figArea2_fig9_type	Set/Get	4: Wide line, 8: Rectangle, 16: Ellipse, 64: Circumfer- ence, 256: Wide arc, 512: Polygon
:	:	:	:	:
93,000	End point figure Count	figArea3_count	Set/Get	0 to 1
93,001	End point figure0 Type	figArea3_fig0_type	Set/Get	4: Wide line
93,002	End point figure0 mode	figArea3_fig0_mode	Set/Get	0: OR
93,009	End point figure0 Wide line Start point X	figAr- ea3_fig0_lineW_X0	Set/Get	-99,999 to 99,999
93,010	End point figure0 Wide line Start point Y	figAr- ea3_fig0_lineW_Y0	Set/Get	-99,999 to 99,999
93,011	End point figure0 Wide line End point X	figAr- ea3_fig0_lineW_X1	Set/Get	-99,999 to 99,999
93,012	End point figure0 Wide line End point Y	figAr- ea3_fig0_lineW_Y1	Set/Get	-99,999 to 99,999
93,013	End point figure0 Wide line Width	figAr- ea3_fig0_lineW_W	Set/Get	0 to 99,999
93,099	End point figure Up- date	figArea3_update	Set only	1: Update

2-36 AI Fine Matching

This processing item cannot be used in the FHV series.

Performs training with “non-defective” images and detects the difference between the input image and the non-defective image. Allows for variations in non-defective image and detects only defects.

Used in the Following Case

When you want to detect minute defects on the boundaries of characters and patterns with high accuracy:

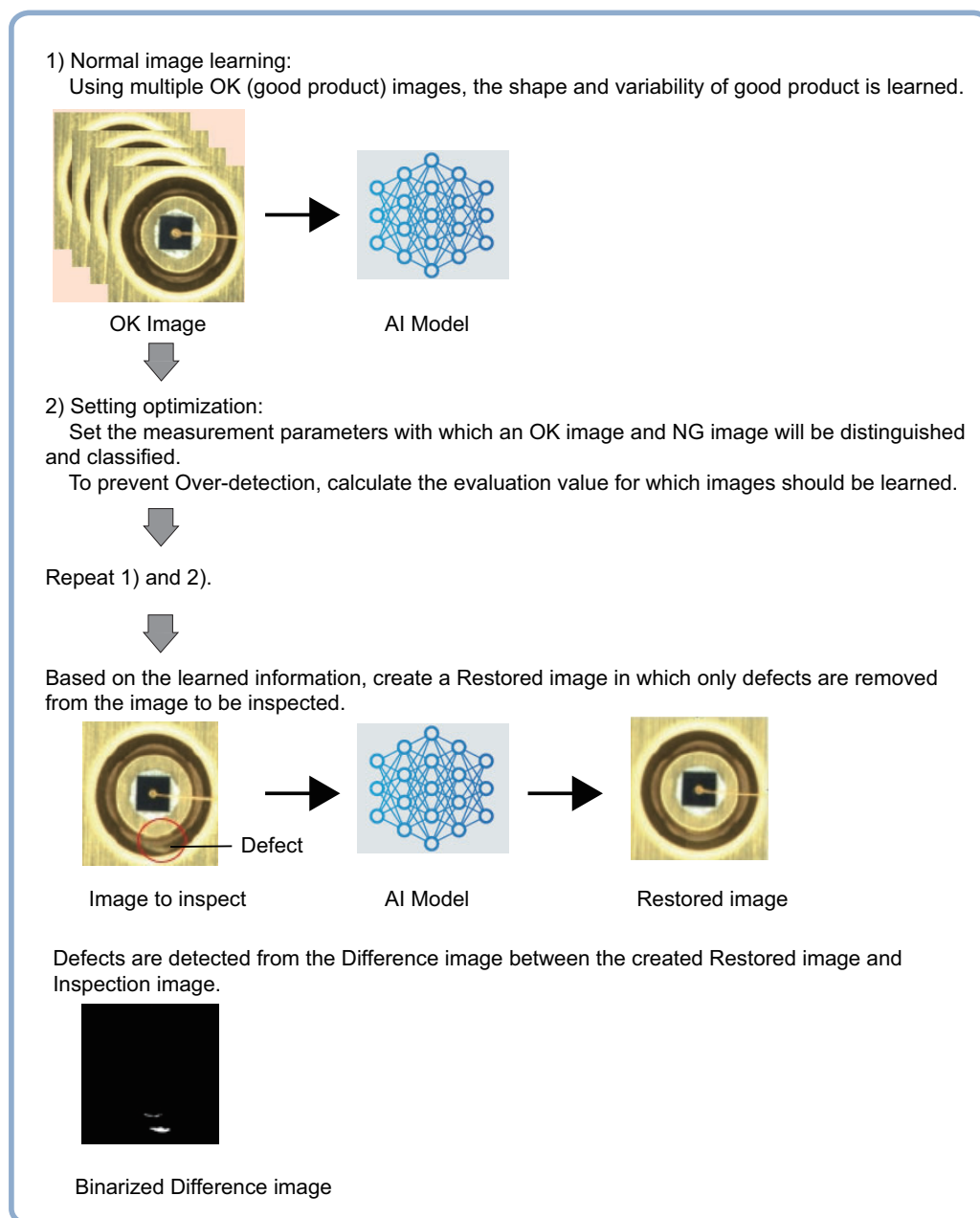



Precautions for Correct Use

- This processing item is supported in the following models.
 - FH-2000/FH-5000 Series
 - FH-L551/FH-L551-10
 For the FH-L551 / FH-L551-10, be sure to use the 0.3 megapixels camera or the 0.4 megapixels camera.
- It is not possible to use the Remote Operation Tool included with the 32bit version of the Simulation Software to control the device or change settings. Use only the 64bit software version to control the device.
- It cannot be used in Multi-line Random Trigger Mode.

If training is performed in Non-stop adjustment mode, the measurement time may become longer.
- Processing is different for color images and monochrome images. When the camera type used in the previous setup was changed to color or monochrome type, perform the settings again.
- In this processing item, the images for **Normal Image learning / Setting optimization** and for the result of Normal image learning are retained in a file as trained model data. Use it with the sensor controller connected to an external storage device such as SSD that can be accessed at high speed.

When using an external storage such as NAS (Network Attached Storage) that takes a long time to access, the UI operation for **Normal image learning** and **Setting optimization** for accessing data will be slow.

If you directly over-write the Trained model file using the FTP function, etc., the replaced Trained model will not be reflected in the measurement.

When switching Trained model during operation, change the **Trained model file name** in Measurement parameters.
- Since trained model is read into the sensor controller when switching scenes, scene groups, and layouts, the processing time may be longer when this processing item is used.
- It is recommended to set the following data in folders using the **Quick access setting tool**.
 - Image file
 - Trained model
 - Working folder

"Image data for training" and "Trained model for measurement" can be included as types of data for the **Configuration Copy function**. This facilitates data transfer between the actual controller and simulation software, as well as data transfer done when increasing the production throughput of the inspection equipment.

For information on Quick access, refer to *Register frequently used folders for easy access [Quick access setting tool]* in *Vision Sensor FH/FHV Series Vision System User's Manual (Z365)*.

Refer to *Backing up Sensor Controller Setting Data [Configuration Copy]* in *Vision Sensor FH/FHV Series Vision System User's Manual (Z365)*.

2-36-1 Settings Flow (AI Fine Matching)

To set AI Fine Matching, follow the steps below.

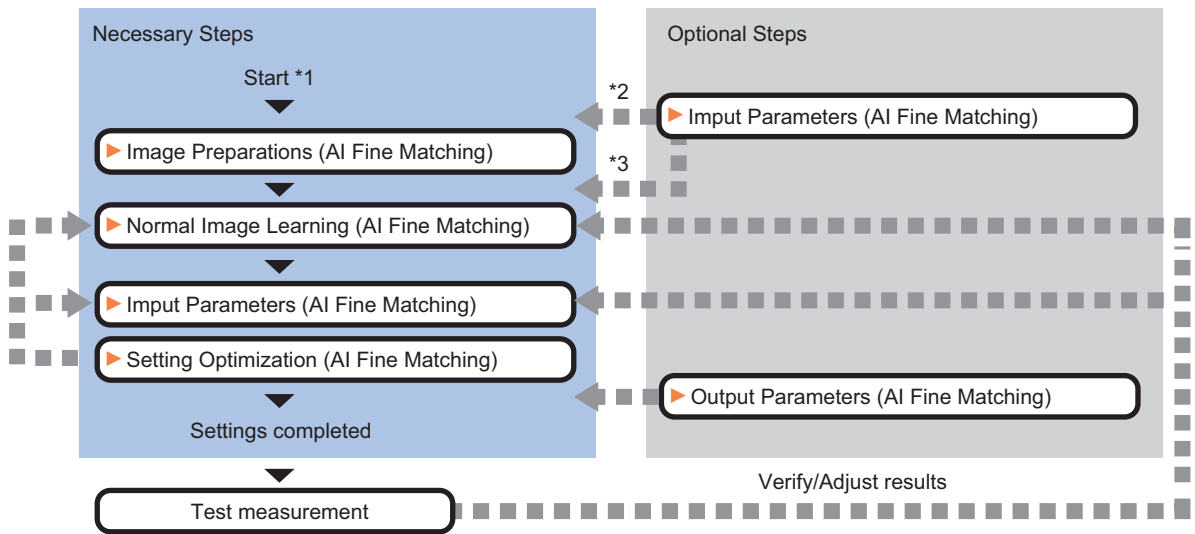

*1 Before starting these settings, set Image logging for OK Images and NG Images.

*2 If you set [Input parameters] - [Option] - [Fixed phrase of Comment] before [Image preparations], you can easily set the same comment for repeated use.

*3 Before [Normal image learning], set [Input parameters] - [Option] - [Working folder]. If not set, RAMDisk will be used for the Working folder, so [Normal image learning] or [Setting optimization] may fail with "Insufficient memory for work folder path".

List of AI Fine Matching Inspection Items

Item	Description
Image preparations	Select the OK images to be learned, and the OK image files and NG image files with which to evaluate the training results and optimize the parameters. After the classification of the images used for Normal image learning and Setting optimization, image preparation is completed. 2-36-2 <i>Image preparations</i> on page 2-578
Normal image learning	Set the training range for OK images and generate trained model. Basically, first select one OK image and generate trained model. 2-36-3 <i>Normal image learning</i> on page 2-585
Setting optimization	Optimize the measurement parameters using the OK images and NG images. Check the optimization results and repeat Normal image learning and Setting optimization until all images are as you intended. 2-36-4 <i>Setting optimization</i> on page 2-593
Input parameters	Set the input parameters. You can change parameter values and assign variables 2-36-5 <i>Input Parameters (AI Fine Matching)</i> on page 2-610
Output parameters	Display the measurement results that can be output. You can assign variables for parameters. 2-36-6 <i>Output parameters (AI Fine Matching)</i> on page 2-614



Additional Information

When you select an image file in the file list on the setting screen for this processing item, the following processing is automatically executed.

- The measurement flow is executed using the image file selected in the list as the input image.
- The images obtained by the above measurement flow are reflected on the setting screen for this processing item.

2-36-2 Image preparations

Select the OK images to be learned, and the OK image files and NG image files with which to evaluate the training results and optimize the parameters.

After the classification of the images used for Normal image learning and Setting optimization, image preparation is completed.

Perform Image preparation with logged images of good product and defective product in advance.



Precautions for Correct Use

Image files with extensions .ifz, .bfz, and .bmp can be used. Image file types such as .jpg or .jfz are not supported.

Select Image file

- 1 Click on the **Image preparations** tab.

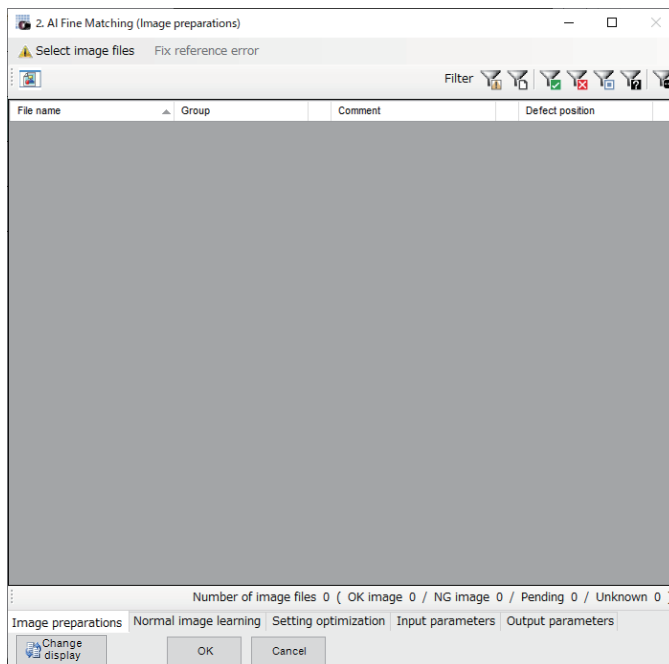

If no image files are selected, the  icon is displayed.

- 2 Click on **Select image file**.
The **Select image file** dialog opens.

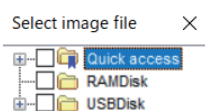

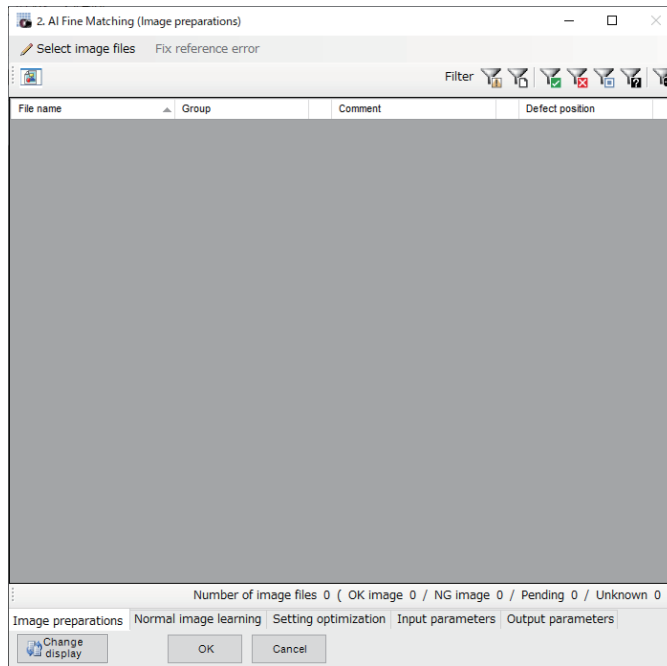

The  icon is displayed in Select image file.





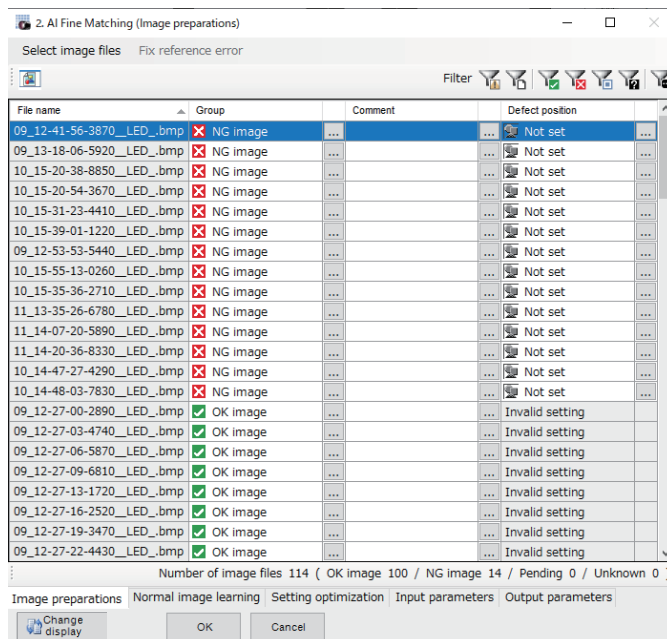



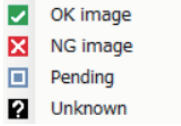

- 3** In the **Select image file** dialog, select the folder that contains the image you want to select. Select the folder by checking the check box to the left of the folder. You can select multiple folders in the **Select image file** dialog. The **Image preparations** tab screen will display a list of image files contained in the selected folders.

- 4** Classify the images. Click the  icon next to the Group cell to classify the image.



Item	Description
 (image preview)	Click to open the Image preview screen. The selected image is displayed on the Image preview screen. *1
File name	The files in the folder selected in Select image file are displayed in a list.

Item	Description
<p>Group</p> 	<ul style="list-style-type: none"> • OK Image: Register as an OK image. The images classified as <i>OK image</i> are displayed as a list for Normal image learning and Setting optimization. • NG Image: Register as an NG image. The images classified as <i>NG image</i> are displayed as a list of NG images to use for Setting optimization. You can set the position of the defect. Refer to <i>Defect position setting</i> on page 2-581. • Pending: Images for which classification is pending. The images are classified separately from the OK and NG images. Images in this Group category will not appear in the list of files in the subsequent settings for Normal image learning or Setting optimization. You can set the position of the defect. Refer to <i>Defect position setting</i> on page 2-581. • Unknown: For images that are not classified. Images in this Group category will not appear in the list of files in the subsequent settings for Normal image learning or Setting optimization.
<p>Comment</p>	<p>You can add a comment as desired. You can set the text by referencing to the Fixed phrase of comment on the Input parameters tab. Comments in all supported languages can be entered. Refer to <i>Inputting Text</i> in <i>Vision System FH/FHV Series User's Manual (Z365)</i> If <i>Unknown</i> is selected in Group, a comment cannot be entered.</p>
<p>Defect position</p>	<p>You can set the position of the defect. Refer to <i>Defect position setting</i> on page 2-581. If <i>OK Image</i> or <i>Unknown</i> is selected in Group, this item cannot be set.</p>
<p>Filter</p>	<p>Filter the file list displayed. When a display filter is selected, the icon of each display filter is highlighted.</p> <ul style="list-style-type: none">  : Reference error *2  : File name  : Group (OK Image)  : Group (NG Image)  : Group (Pending)  : Group (Unknown)  : Comment
<p>Number of image files (OK Image / NG Image / Pending / Unknown)</p>	<p>The number of selected image files and the number in each Group category are displayed regardless of the Display filter set.</p>

*1. Image preview screen:

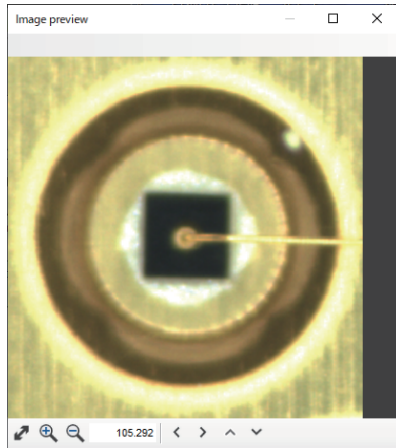

- *2. Reference error: If you delete or move the selected image file or change the file name, ! is displayed to the right of the File name column to indicate a File reference error.

C:\Users\#Documents\OMRON FZ#RAMDisk\OK#test00.bfz !

If Reference error is displayed, **Execute training**, **Execute optimization** and **Batch measurement** cannot be performed.



Additional Information

- By clicking on the label at the top of a column, you can sort the list by that item. The default is to sort by the file name which includes the folder name.
- By right-clicking on the file list, you can set the Group and Comment. Using the [SHIFT] key and [CTRL] key in the file list, right-click with multiple files selected to make batch settings.
- When an image file is added to the folder selected with **Select image file**, the added image file can be displayed in the file list by reopening the setting screen of this processing item and selecting the folder with **Select image file** again.
- A file with a Reference error whose Group classification is set to *Unknown* will be deleted from the file list when the setting screen for this processing item is opened again.

- 5** Press the **x** at the top right of the **Select image file** dialog to close the dialog.

When the **Select image file** dialog is closed, the  icon disappears.



Precautions for Correct Use

- The maximum number of files that can be selected with **Select image file** is 3,000. The total number of image files that can be set to *OK image* and *NG image* is 2,000.
- An image selected from a folder set for Quick access and the same image in a folder not set for Quick access are treated as different image files in the file list. For information on Quick access, refer to *Register frequently used folders for easy access [Quick access setting tool]* in *Vision Sensor FH/FHV Series Vision System User's Manual (Z365)*.

● Defect position setting

Set the position of the defect in the image with a Polygon figure.

In an image classified as *NG image* or *Pending*, set the part you want to detect as a defect.

The Defect position setting is used for the following two purposes.

- Set it to mark the defect you want to detect.

Set the position of the defect in the image with a Polygon figure.

The Defect position set can be confirmed during Image preview.

- Defect position is used as a corrective action when performing **Setting optimization** in cases where the position of a defect is not being detected.

By checking **Teaching** when executing **Setting optimization**, the measurement parameters will be optimized so that defects are detected in the set area.





Additional Information

Setting the Defect position is optional. You can continue the settings flow in this processing item without setting the Defect position.

- 1 Click  in the **Defect position** cell. It can be set for files classified as *NG image* or *Pending* in the **Group** column.

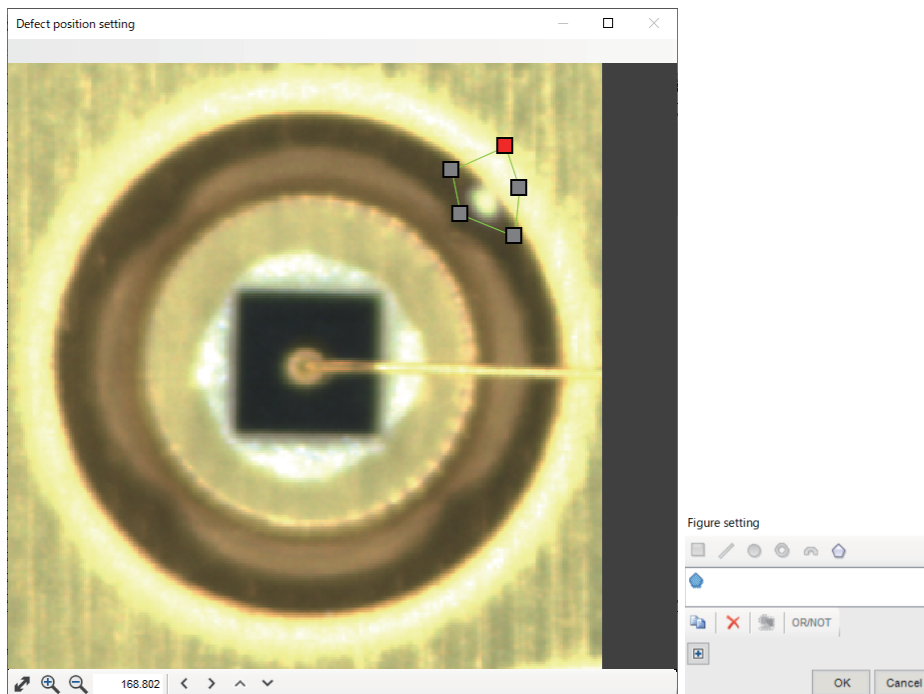
The **Defect position setting** screen and **Figure setting** dialog are displayed.



- 2 Click  on the **Figure setting** dialog to set the Defect position with the Polygon figure.



Additional Information

If the position of the defect cannot be detected when **Settings optimization** is executed, set it to include all defects in the image. You can set up to 15 defect positions for each image file. Make sure to set the Defect position so that it does not include a part where the image does not change due to the defect.

- How to set:

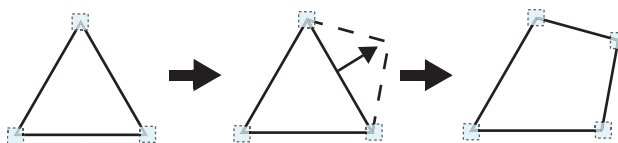

- 1) When you select a **polygon**, a triangle is drawn first.

2) Drag and drop an edge to the place you want to make a vertex and a vertex will be added.

If the number of vertices is not between 3 to 10, it will not be confirmed as a polygon.

- When figure is selected

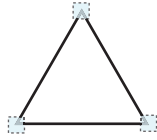

A point is displayed at the vertex of the figure.

- Size adjustment

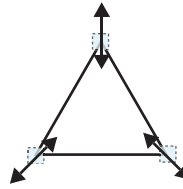

Drag the point.

- Example) When changing the angle of one point

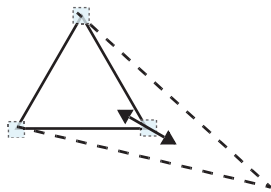

Drag the point you want to change.

- Example) When changing the area

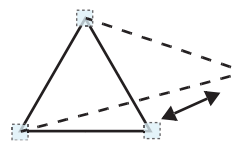

Drag the point you want to change.

When you click the **+** button in the dialog, the **position** of the vertices are displayed. You can also set it numerically from this screen.

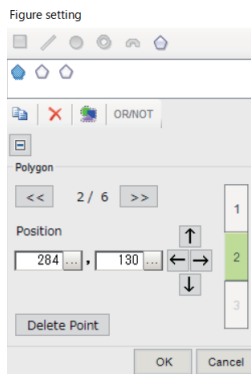

Click the **1** button to display the **center position**. You can also set it numerically from this screen again. You can also set it numerically from this screen.

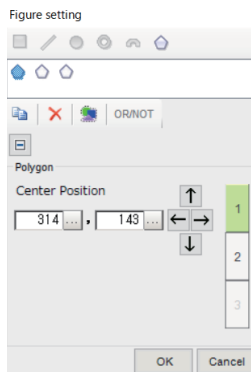

Click the **2** button to display the **position** of the vertices.

3 Click the **OK** button on the **Figure setting** dialog to close the **Defect position setting** screen.

Fix Referenc Error

If you delete or move the selected image file or change the file name, the  icon is displayed to the right of the File name column to indicate a File reference error.

When the **Select image file** dialog is closed, the  icon disappears.

10_15-20-38-8850_LED_.bmp 

If Reference error is displayed, **Execute training**, **Execute optimization** and **Batch measurement** cannot be performed.

Click the **Fix reference error** to display the **Fix reference error** dialog.

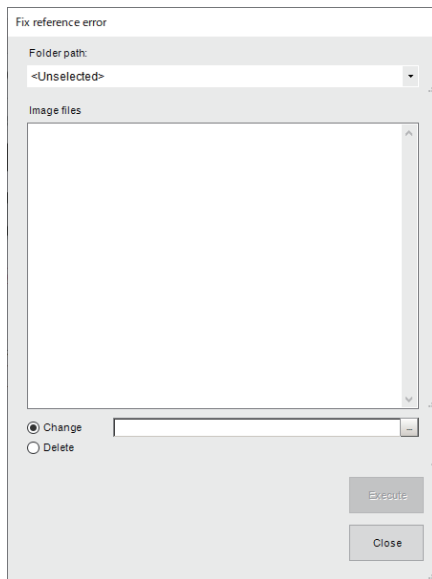

You can change the folder path for the reference error.
It is also possible to delete the image files from the list.

Item	Description
Folder path	You can select the folder path that contains the image files causing the reference error.
image files	This lists the file names of the image files causing the reference error in the folder selected in <i>Folder path</i> .
Change	Place a check here to change the folder path for the image files causing the reference error.
Changed folder path	If Change is checked, specify the folder path after change.
Delete	Place a check here to delete the image files causing the reference error from the list.
Execute button	Click this button to change the image file folder path or remove the image files from the list.
Close button	Click this button to close the Fix reference error dialog.



Additional Information

- You cannot click **Fix reference error** while the **Select image files** dialog is open.
- You cannot click **Fix reference error** when there is no file reference error.

2-36-3 Normal image learning

Set the training range for OK images and generate trained model.

Basically, first select one OK image and generate trained model.

Follow the flow below to perform training on OK images.

When the training is completed, the measurement process can be executed.

1. Specifying the learning range (*Measurement region* on page 2-585)
2. Generating trained model (*Execute training* on page 2-590)



Additional Information

It is also possible to use already created trained model without performing Normal image learning. In that case, select the trained model to be used for the **Trained model's file name** setting on the **Input parameters** tab.

Measurement region

Set the Training region.

Training processing is performed for the region set here.

Be sure to always perform Execute training after setting the Measurement region. The measurement is performed not on the current Measurement region but on the Measurement region set when Normal image learning is executed.



Additional Information

The Measurement region set here is saved in the Trained model file and used in the measurement process.

- 1 Click on the **Normal image learning** tab.

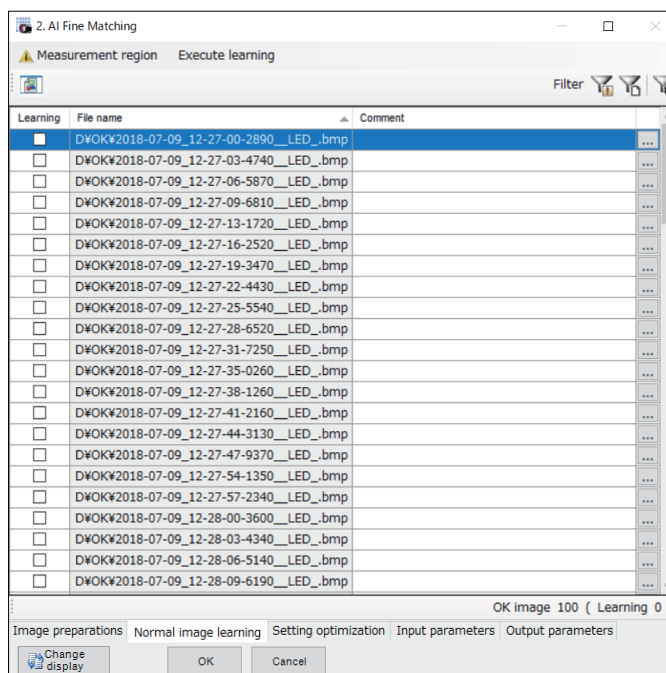

- 2 Click **Measurement region**.

The **Measurement region** screen and **Figure setting** dialog are displayed.

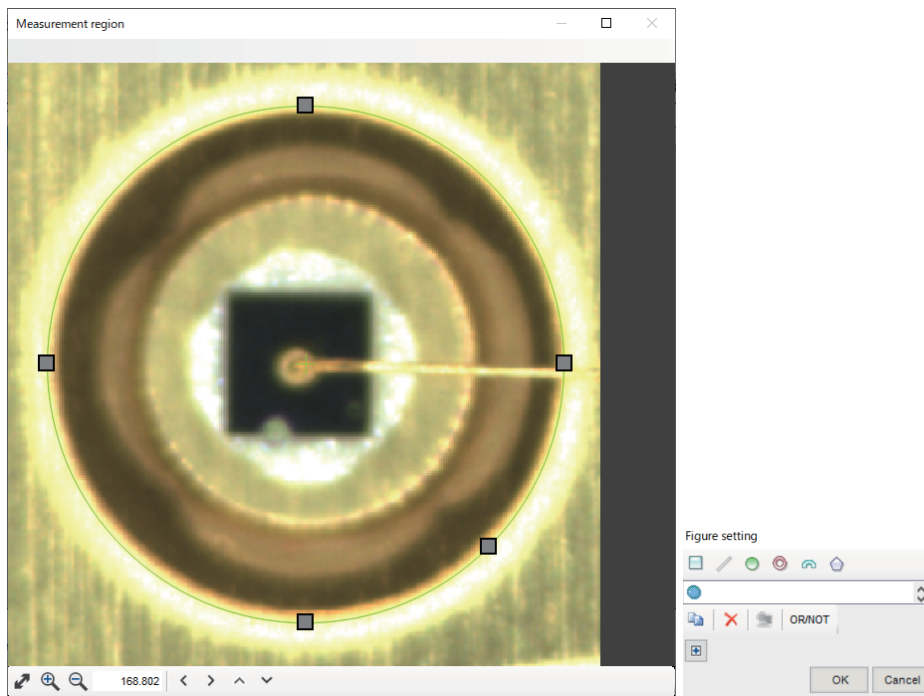

3 Set the Measurement region using a figure.

Up to 8 figures can be set.

Refer to *Rectangle* on page 2-586, *Circle/Ellipse* on page 2-587, *Circumference* on page 2-587, *Arc with width* on page 2-588, *Polygons (Triangle to Decagon)* on page 2-589.

4 Click **OK** to close the dialog.



Precautions for Correct Use

There is a limit to the size of the Measurement region.

- The Measurement region should be 2,448 × 2,048 (5M size) or smaller.
- The Measurement region should be 128 × 128 or larger.

● Rectangle

- Image selection state

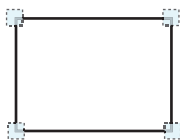

Points are displayed at each of the four corners.

- Dimension Adjustment

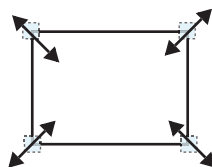

- Example: When enlarging

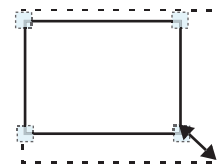

Drag the lower right point down in a diagonal direction.

- Using numbers for setting

The setting area consists of two windows below. Click the **1** or **2** on the right side of the window to select the setting item.

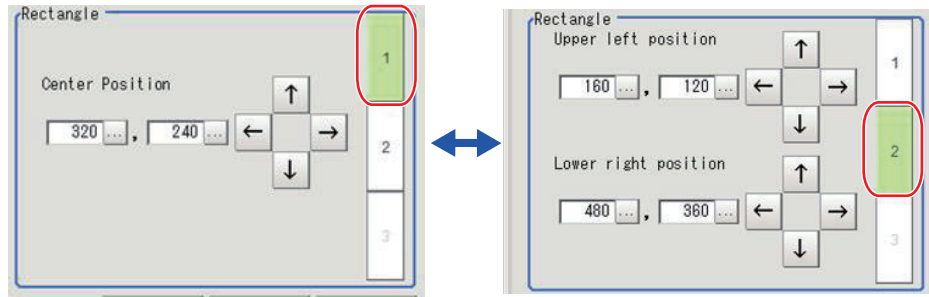

● Circle/Ellipse

- Image selection state

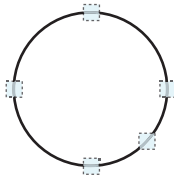

Points are displayed on the top, bottom, left, right, and lower right of the circle.

- Dimension Adjustment

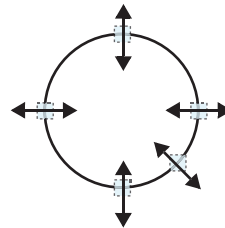

Drag the points.

- Example: When zooming in on a circle

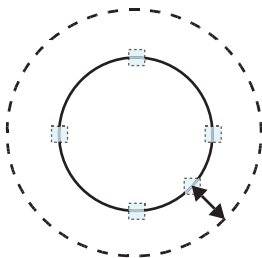

Drag the point on the lower right of the circle.

- Example: When transforming a circle into a long horizontal ellipse

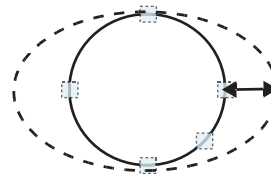

Drag the point on the right of the circle to the right.

- Using numbers for setting

The setting area consists of two windows below. Click the 1 or 2 on the right side of the window to select the setting item.

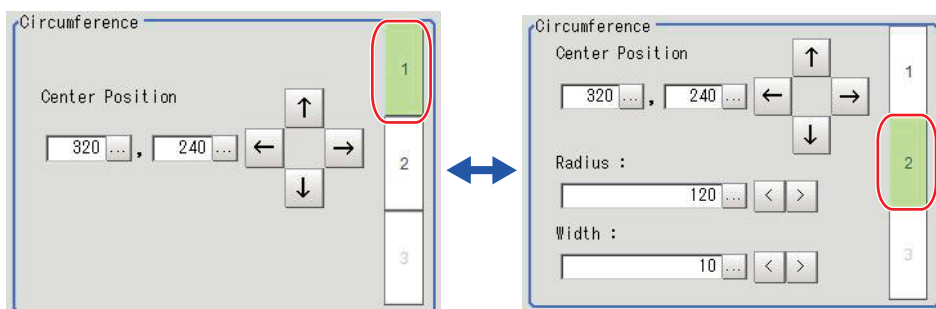

● Circumference

- Image selection state

- Dimension Adjustment

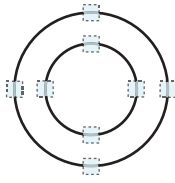

Points are displayed on the top, bottom, left, and right of both the inner and outer circles.

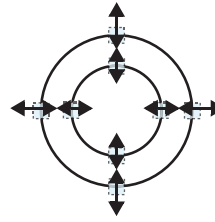

Drag the points.

- Example: When enlarging the entire circumference

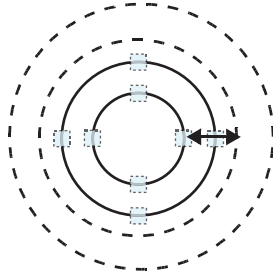

Drag a point on the outer circle.

- Example: When adjusting the width of the circumference

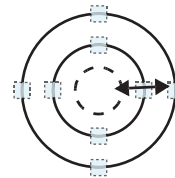

Drag a point on the inner circle.

- Using numbers for setting

The setting area consists of two windows below. Click the **1** or **2** on the right side of the window to select the setting item.

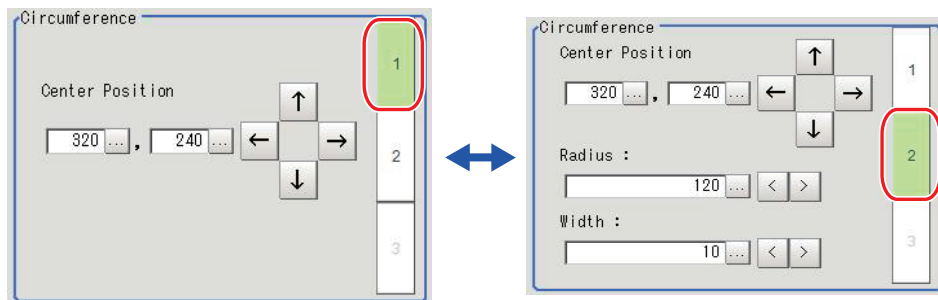

● Arc with width

- Image selection state

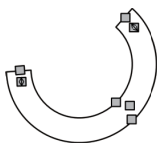

Points are displayed on two lines at both ends of the arcs, inside of the two lines at both ends of the arcs, on the inner arc, on the outer arc, and inside the closed arc shape.

- Dimension Adjustment

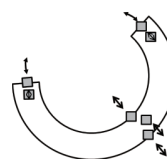

Drag the points.

- Example: When enlarging an arc

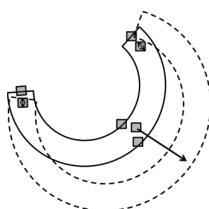

Drag the point inside the arc outward.

- Example: When adjusting the width of an arc

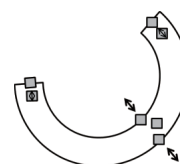

Drag a point on the inner or outer arc inward or outward.

- Example: When changing the angle of arc (part that is open)

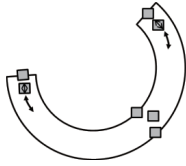

Drag one of the points inside of the two lines at both ends of the arcs.

- Using numbers for setting

The setting area consists of three windows below. Click the 1, 2, or 3 on the right side of the window to select the setting item.

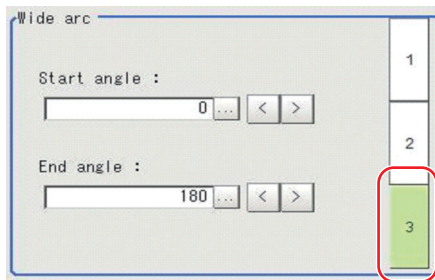
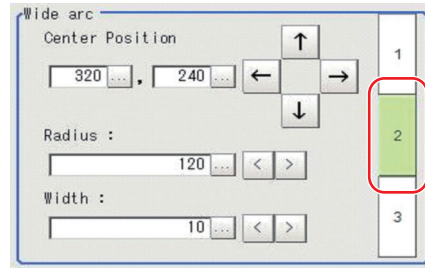
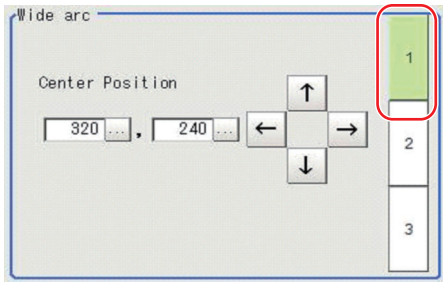

● Polygons (Triangle to Decagon)

- Drawing methods (for drawing a quadrilateral)

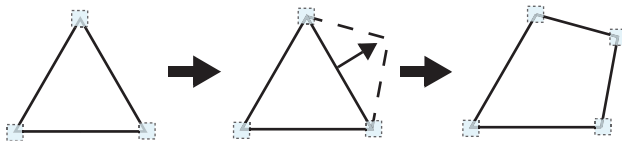

- When **Polygon** is specified, a triangle is drawn at first.
- If you drag and drop one of the sides at the point you want to make a new vertex, a new vertex will be created.

If the number of vertices is not within 3 to 10, the image cannot be confirmed as a polygon.

- Image selection state

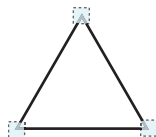

Point is displayed at vertex of figure.

- Dimension Adjustment

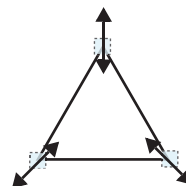

Drag the points.

- Example: When changing the angle of one point

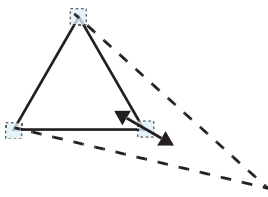

Drag points (arbitrarily).

- Example: When changing the region

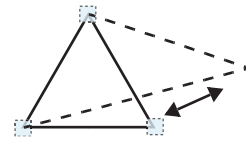

Drag points (arbitrarily).

- Using numbers for setting

The setting area consists of two windows below. Click the **1** or **2** on the right side of the window to select the setting item.

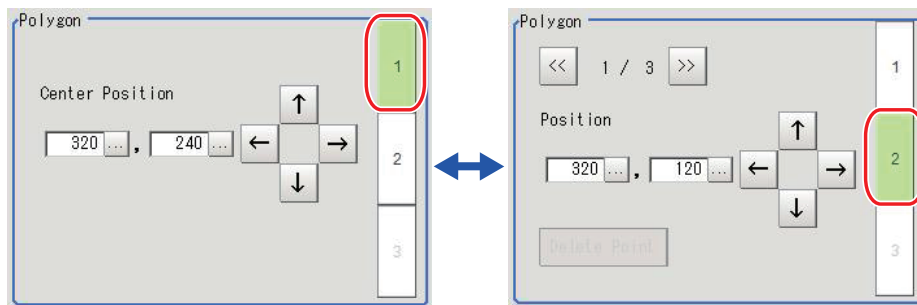



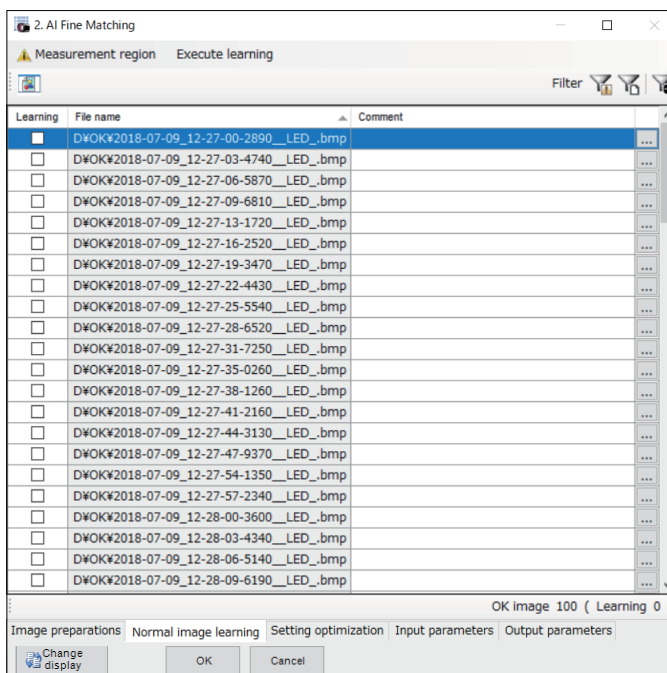

Execute training

Learn an OK image and create a trained model file to use for inspection.

- 1** From **Input Parameters** tab - **Option** - Set the **Working folder**.
Select external storage because it requires a lot of space.
- 2** In the file list, check the OK image to use for training.



Item	Description
 (Training Image preview)	Click to open the Training Image preview screen. The selected image is displayed on the Training Image preview screen. *1
Training	Check the OK image to use for training.
File name	The images classified as OK images in Select image file are displayed in the list.
Comment	You can add a comment as desired. You can set the text by referencing to the Fixed phrase of comment on the Input parameters tab. Comments in all supported languages can be entered. Refer to <i>Inputting Text in Vision System FH/FHV Series User's Manual (Z365)</i>
Filter	Filter the file list displayed. When a display filter is selected, the icon of each display filter is highlighted.  : Reference error *2  : File name  : Comment
OK image (Training)	The number of OK image files and the number checked for Training are displayed regardless of the display filter.

*1. Training Image preview screen:

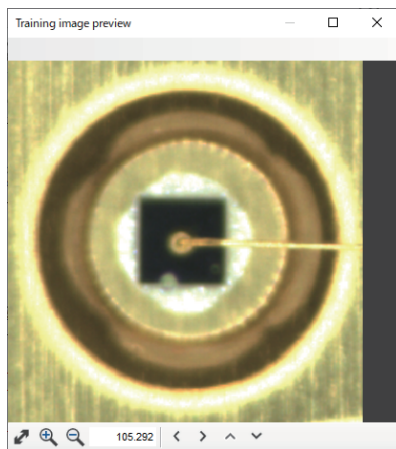

*2. Reference error: If you delete or move the selected image file or change the file name, ! Is displayed to the right of the File name column to indicate a File reference error.

C:\Users\%Documents%\OMRON FZ\RAMDisk\OK\test00.bfz !

If Reference error is displayed, **Execute training**, **Execute optimization** and **Batch measurement** cannot be performed.



Additional Information

- By clicking on the label at the top of a column, you can sort the list by that item. The default is to sort by the file name which includes the folder name.
- By right-clicking on the file list, you can check the items for Training and comments for Training.
Using the [SHIFT] key and [CTRL] key in the file list, right-click with multiple files selected to make batch settings.

- 3** Click on **Execute training**.
The **Execute training** dialog opens.

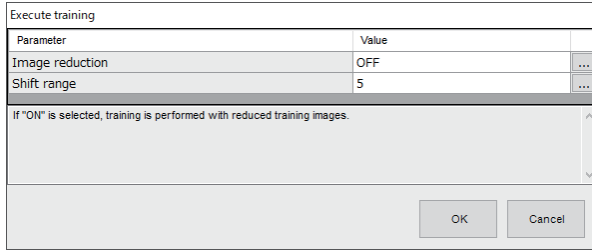

- 4** Set the following parameters.

Setting Item	Setting value [Factory default]	Description
Image reduction	<ul style="list-style-type: none"> ON [OFF] 	When set to <i>ON</i> , training is performed after reducing the training image. When <i>ON</i> , the measurement time is halved compared to when <i>OFF</i> , but the defect detection performance is reduced.
Shift range	0 to 30 [5]	The training images are translated in parallel by the set value (pixel) to increase the number of training images. Even if the position of the inspection object changes on the image input to this processing item, it is possible to prevent over-detection and miss detections.

- 5** Click **OK**. **FileExplorer** will open. When you specify the file name to save the learning result in **FileExplorer**, the learning will start.

Select external storage because it requires a lot of space.

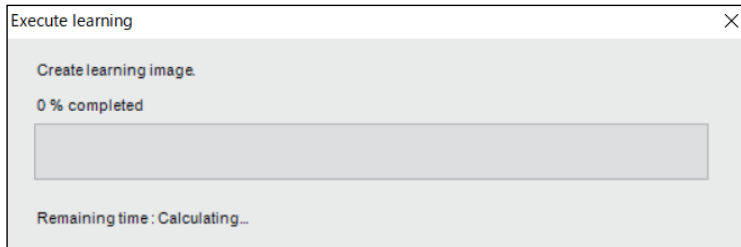

If you want to stop before completion, you can cancel it by pressing the **x** at the top right of the dialog.



Precautions for Correct Use

The remaining time display is only a reference value. It's not the exact time.

- When learning is completed, a Confirmation dialog box indicating that learning has been completed is displayed.

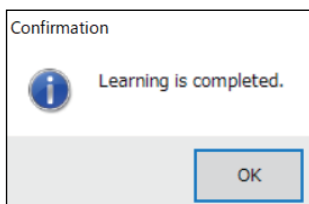

- A Confirmation dialog appears asking if you want to use the created Trained model as it is.

If you select **Yes**, it will be set as Trained model for **Setting optimization - Execute optimization**.

In addition, the **Trained model's file name** of **Input parameters - Measurement parameters** is set to the file path of the created trained model.

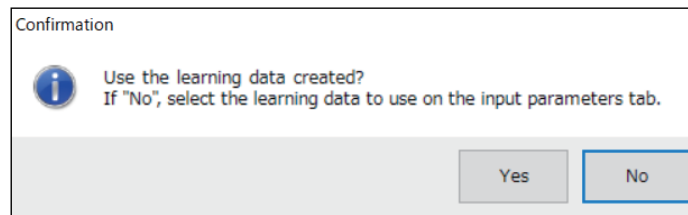

Precautions for Correct Use

- Up to 100 image files can be used for **Training**.

2-36-4 Setting optimization

Optimize the measurement parameters using the OK images and NG images.

Check the optimization results and repeat Normal image learning and Setting optimization until all images are as you intended.

Follow the flow below to perform Optimization.

1. Set the measurement parameters (*Set the Measurement Parameters* on page 2-593)
2. Execute optimization (*Execute optimization* on page 2-596)
3. Select optimization results (*Confirm optimization result* on page 2-600)

Set the Measurement Parameters

Set the measurement parameters that are not the optimization target in advance.

Among the measurement parameters, set **Defect brightness**, **Normalization**, **Boundary inspection – Active**, **Boundary inspection – Boundary level**, **Filling up holes**, and **Mode** for defects that are not the optimization target. The values set here are used during optimization.

This step is not necessary for the optimization target measurement parameters.

If you have started the setting screen for this processing item from the **TDM Editor**, start from Step 3.

If you did not start the setting screen for this processing item from the **TDM Editor**, start from Step 1.

- 1 Close the setting screen of this processing item and then from the Tool menu on the main screen, select **TDM Editor**.
Refer to *Vision Sensor FH/FHV Series Vision System User's Manual (Z365)* for information on using **TDM Editor**.
- 2 In the **TDM Editor**, open the **AI Fine Matching** processing item.
- 3 Click the **Input parameters** tab.

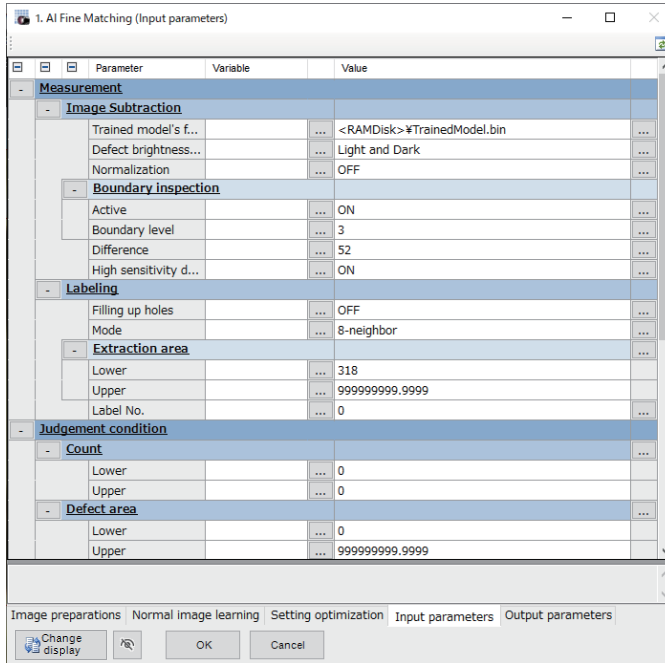

- 4** Confirm that the trained model file (extension: .bin) is set to the **Trained model's file name** of the **Measurement** parameter.

If the **Trained model's file name** is not set, perform Execute training on the **Normal Image**

learning tab. You can also set the Trained model file by clicking the  icon to the right of the value.

- 5** In the **TDM Editor**, set the **sub number** of this processing item to **1**.
Binary difference image appears in the **TDM Editor**. Refer to 2-36-7 *Key Points for Test Measurement and Adjustment (AI Fine Matching)* on page 2-614 for the Sub-image number (sub number).

- 6** Test measure a typical NG image with the **TDM Editor**.
Repeat steps 6 and 7 until the measurement result is *NG* and the defect is correctly extracted.

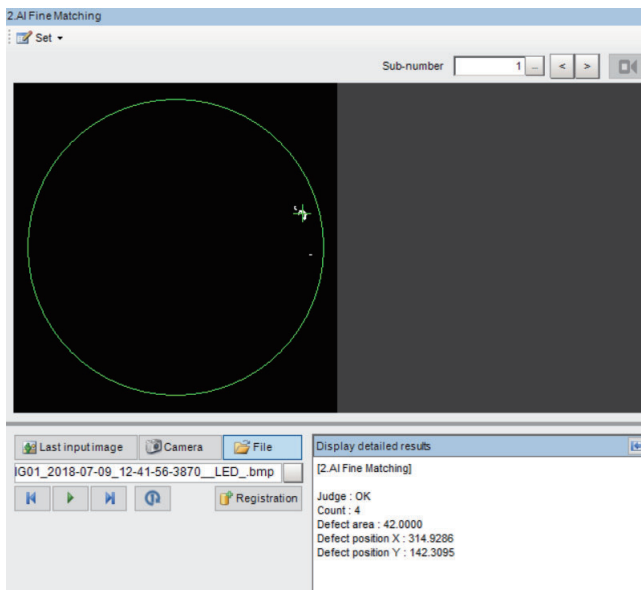

7 Set Measurement parameters.

Among the measurement parameters, set **Defect brightness**, **Normalization**, **Boundary inspection – Active**, **Boundary inspection – Boundary level**, **Filling up holes**, and **Mode** for defects that are not the optimization target. The values set here are used during optimization.

This step is not necessary for the optimization target measurement parameters.

Setting Item	Setting value [Factory default]	Description
Defect brightness (monochrome image only)	<ul style="list-style-type: none"> [Light and Dark] Light Dark 	Select the lightness of the defect you wish to extract (in relation to its background). If you want to detect both light and dark defects, select <i>Light and Dark</i> .
Normalization	<ul style="list-style-type: none"> ON [OFF] 	Select whether to perform normalization according to the lightness of image when training. If <i>ON</i> is selected, even if the lightness of the entire image changes, matching is performed after correcting the density, making it less susceptible to lighting fluctuations. If you perform normalization on a measurement object that has little or no pattern, the overall lightness will change, and you will not be able to perform measurement correctly.
Boundary inspection		
Active	<ul style="list-style-type: none"> [ON] OFF 	When <i>ON</i> , defects near the boundary where the color changes can also be detected. Contours that are the same as the contours of the model image are not judged as defects. Select this when inspecting for defects that appear on the boundary, such as chipping. Within the pixel range of a Contour \pm Boundary level image, scratches in a different direction from the contours of the model image are detected. When <i>OFF</i> , boundary parts are excluded from inspection. Although this will help prevent mis-detections due to any shifting of the measured object position, defects near the boundary cannot be detected. The number of pixels near the boundary to exclude from inspection is set by Boundary level .
Boundary level	0 to 9 [3]	Sets the degree to which boundary variations are absorbed in pixels. The role this plays differs depending on whether Boundary inspection is enabled.
Filling up holes	<ul style="list-style-type: none"> ON [OFF] 	Select how to process the part surrounding the defect. When set to <i>ON</i> , it will be processed as the defect.
Mode	<ul style="list-style-type: none"> 4-Neighbor [8-Neighbor] 	Specify the conditions to use for defects. <ul style="list-style-type: none"> 4-Neighbor: The contiguous parts at the top, bottom, left and right of the target pixel are processed as the same defect. 8-Neighbor: Parts in the diagonal direction are added to the contiguous parts at the top, bottom, left and right of the target pixel to be processed as the same defect.

Execute optimization



Additional Information

By executing optimization, the following measurement parameter candidates are automatically calculated.

- **Difference**
- **High sensitivity defect extraction**
- **Extraction area**

The other **Measurement** parameter uses the **Input parameter** setting.





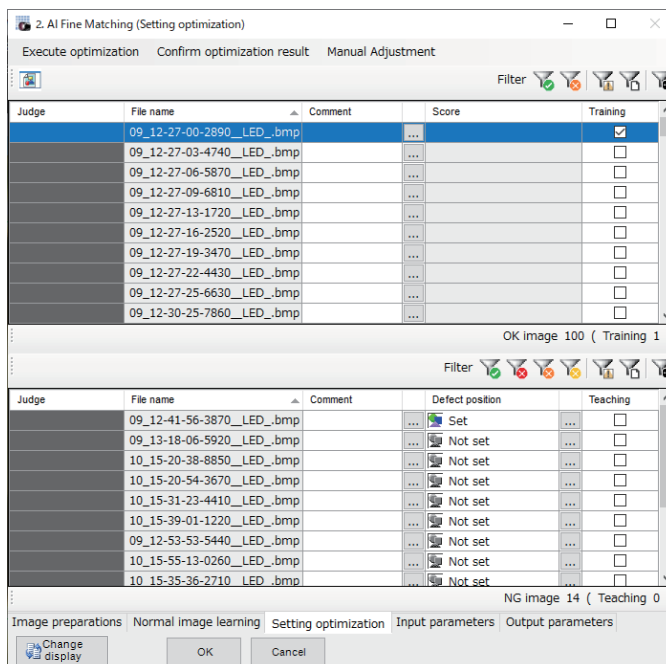

The default value is used as the **Judgment condition**.

For more information on Input parameters, refer to 2-36-5 *Input Parameters (AI Fine Matching)* on page 2-610.

- 1 From **Input Parameters** tab - **Option** - Set the **Working folder**.
Select external storage because it requires a lot of space.
- 2 Click the **Setting optimization** tab.



Item	Description
 (Measurement image preview)	Click this to open the Measurement image preview screen. The selected image is displayed in the Measurement image preview screen. You can check the image on the Measurement image preview screen of Setting optimization. *1 Refer to <i>Confirm optimization result</i> on page 2-600.
Judge	The Judgement result is displayed. Refer to <i>Confirm optimization result</i> on page 2-600.
File name	Images that have been classified as OK image in Select image file are displayed at the top of the list. Images that have been classified as NG image in Select image file are displayed at the bottom of the list.

Item	Description
Comment	<p>You can add a comment as desired.</p> <p>You can set the text by referencing to the Fixed phrase of comment on the Input parameters tab.</p> <p>Comments in all supported languages can be entered. Refer to <i>Inputting Text in Vision System FH/FHV Series User's Manual (Z365)</i></p>
Score	<p>Evaluation values from 0 to 255. The higher the score, the more characteristics of the image that differ from the current trained model.</p> <p>Refer to <i>If a False detection occurs for the OK image: Add a Training image.</i> on page 2-608.</p>
Training	<p>Check the OK image to use for training.</p> <p>Refer to <i>If a False detection occurs for the OK image: Add a Training image.</i> on page 2-608.</p>
Defect position	<p>You can set the position of the defect. Refer to <i>Defect position setting</i> on page 2-581.</p>
Teaching	<p>Check this to enable the set Defect position to be used. Refer to <i>If Defect detection cannot be performed on the defect position to be detected in an NG image: Use that defect position in Optimization.</i> on page 2-609.</p>
Filter	<p>Filter the file list displayed.</p> <p>When a display filter is selected, the icon of each display filter is highlighted.</p> <ul style="list-style-type: none">  : Corrcct  : Miss  : Over  : Miss & Over  : Reference error *2  : File name  : Comment
OK image (Training)	<p>The number of OK image files and the number checked for Training are displayed regardless of the display filter.</p>
NG image (Teaching)	<p>The number of NG image files and the number checked for Teaching are displayed regardless of the Display filter.</p>

*1. Measurement image preview screen:

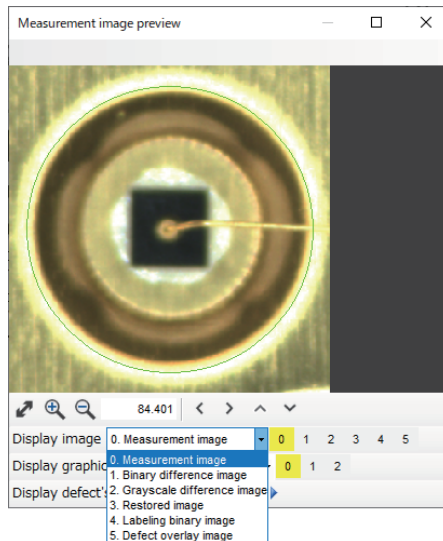

- *2. Reference error: If you delete or move the selected image file or change the file name, ! is displayed to the right of the File name column to indicate a File reference error.

C:\Users\%Documents%\OMRON FZ\RAMDisk\OK\test00.bfz !

If Reference error is displayed, **Execute training**, **Execute optimization** and **Batch measurement** cannot be performed.



Additional Information

- By clicking on the label at the top of a column, you can sort the list by that item. The default is to sort by the file name which includes the folder name.
- By right-clicking on the file list, you can set checks and comments used for Group / Learning / Teaching.
Using the [SHIFT] key and [CTRL] key in the file list, right-click with multiple files selected to make batch settings.

3 Click on **Execute optimization**.

The **Execute optimization** dialog opens. Click **OK** to start the optimization.

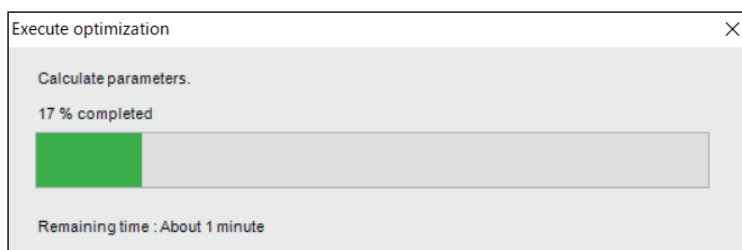
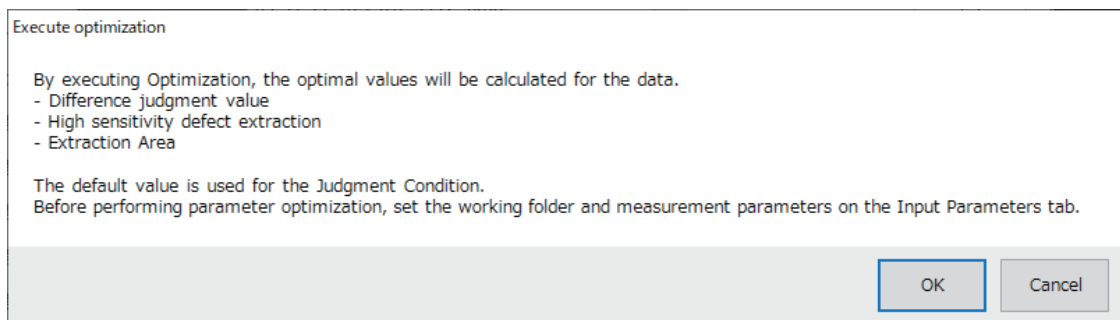

After optimization, the parameter values are optimized.

If you want to stop before completion, you can cancel it by pressing the **x** at the top right of the dialog.



Precautions for Correct Use

The remaining time display is only a reference value. It's not the exact time.

4 Click **OK**.

When the optimization is complete, the following dialog will be displayed.

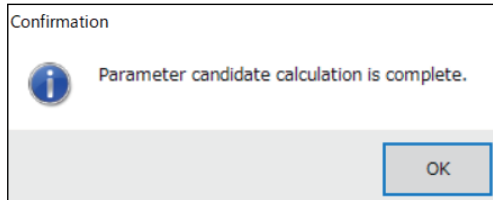

When the dialog is closed, the **Confirm optimization result** dialog is displayed.

The evaluation results for OK and NG images with the optimized measurement parameters are displayed line by line.

When you click **OK** in the **Confirm optimization result** dialog, the parameter values of the selected pattern are reflected in the measurement parameters. The **Judgment condition** will be the default value.

If you click **Cancel**, the result of the **Execute optimization** will not be reflected.

Confirm optimization result

Correct	Miss	False	Error
56	0	58	0
93	1	20	0
94	2	18	0
94	3	17	0
97	4	13	0
98	5	11	0
99	6	9	0
100	7	7	0
99	8	7	0
95	9	10	0

Parameter	Value
Image Subtraction	
Difference	58
High sensitivity defect extraction	ON
Labeling	
Extraction area	
Lower	156.000000
Upper	99999999.999900

Also, the optimization result is reflected in the file list on the **Settings optimization** tab screen.

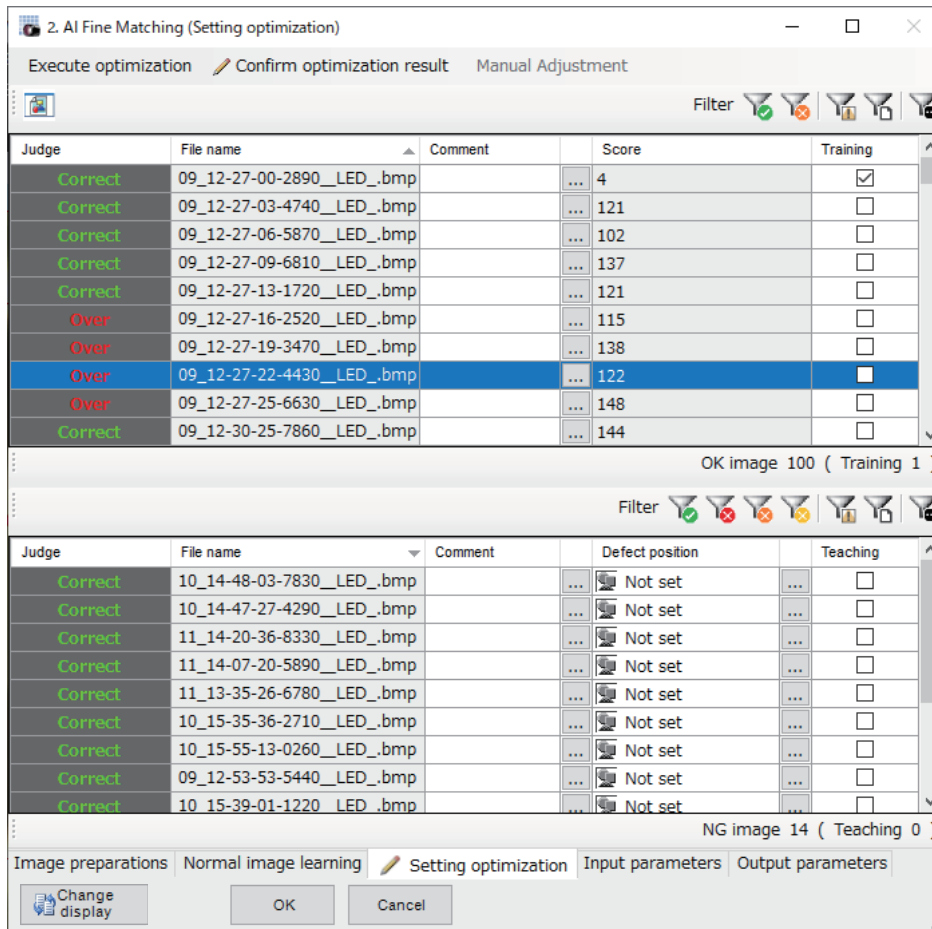

For checking the optimization result, see *Confirm optimization result* on page 2-600.

Confirm optimization result

Check the Optimization results, decide the parameters to be used at the time of measurement, and select the image for recreating the trained model.

1 Click the **Setting optimization** tab.

2 Click on **Confirm optimization result**.

The **Confirm optimization result** dialog opens.

The evaluation results for OK and NG images with the optimized measurement parameters are displayed line by line.

Confirm optimization result

Correct	Miss	False	Error
56	0	58	0
93	1	20	0
94	2	18	0
94	3	17	0
97	4	13	0
98	5	11	0
99	6	9	0
100	7	7	0
99	8	7	0
95	9	10	0

Parameter	Value
Image Subtraction	
Difference	58
High sensitivity defect extraction	ON
Labeling	
Extraction area	
Lower	156.000000
Upper	999999999.999900

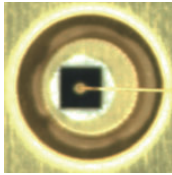
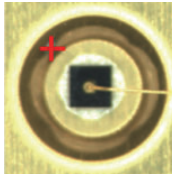
Judgement result	Description
Correct	<p>The number of Correct Judgement results.</p> <ul style="list-style-type: none"> OK image: If no defects are detected in the image  <ul style="list-style-type: none"> NG image: If defects are detected in the image For an NG image with Defect position set and Teaching checked ON, when defects are detected at all set Defect positions. 

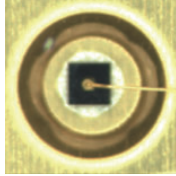
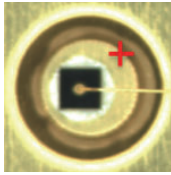
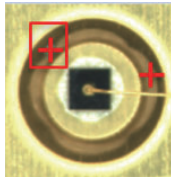
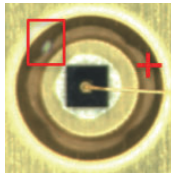
Judgement result	Description
Miss	<p>The number of Miss Judgment results.</p> <ul style="list-style-type: none"> • OK image:None • NG image: If no defects are detected in the image For an NG image with Defect position set and Teaching checked ON, when defects are not detected at the set Defect positions. 
Over	<p>The number of Over Judgment results.</p> <ul style="list-style-type: none"> • OK image: If defects are detected in the image  <ul style="list-style-type: none"> • NG image: Whether the defect is detected at the set Defect position, or a defect is detected at a position other than the set Defect position.(It is judged only for NG images in which the Defect position is set and the Teaching is checked to be ON.) 
Miss & Over	<p>The number of Miss & Over Judgment results.</p> <ul style="list-style-type: none"> • OK image: None • NG image: When no defect is detected at the set Defect position, but a defect is detected at a position other than the set Defect position. (It is judged only for NG images in which the Defect position is set and the Teaching is checked to be ON.) 

At the bottom of the **Confirm optimization result** dialog, you can check the parameter values calculated by Execute optimization.

By executing optimization, the following measurement parameter candidates are automatically calculated.

- **Difference**
- **High sensitivity defect extraction**
- **Extraction area**

For each line of the optimization result, you can check the value of the corresponding parameter.

- 3** By selecting the list of files on the **Settings optimization** tab, you can check the measurement results for OK and NG images when the optimization results are applied on the **Measurement image preview** screen.

Judge	File name	Comment	Score	Training
Correct	09_12-27-00-2890__LED_.bmp		4	<input checked="" type="checkbox"/>
Correct	09_12-27-03-4740__LED_.bmp		121	<input type="checkbox"/>
Correct	09_12-27-06-5870__LED_.bmp		102	<input type="checkbox"/>
Correct	09_12-27-09-6810__LED_.bmp		137	<input type="checkbox"/>
Correct	09_12-27-13-1720__LED_.bmp		121	<input type="checkbox"/>
Over	09_12-27-16-2520__LED_.bmp		115	<input type="checkbox"/>
Over	09_12-27-19-3470__LED_.bmp		138	<input type="checkbox"/>
Over	09_12-27-22-4430__LED_.bmp		122	<input type="checkbox"/>
Over	09_12-27-25-6630__LED_.bmp		148	<input type="checkbox"/>
Correct	09_12-30-25-7860__LED_.bmp		144	<input type="checkbox"/>

Judge	File name	Comment	Defect position	Teaching
Correct	10_14-48-03-7830__LED_.bmp		Not set	<input type="checkbox"/>
Correct	10_14-47-27-4290__LED_.bmp		Not set	<input type="checkbox"/>
Correct	11_14-20-36-8330__LED_.bmp		Not set	<input type="checkbox"/>
Correct	11_14-07-20-5890__LED_.bmp		Not set	<input type="checkbox"/>
Correct	11_13-35-26-6780__LED_.bmp		Not set	<input type="checkbox"/>
Correct	10_15-35-36-2710__LED_.bmp		Not set	<input type="checkbox"/>
Correct	10_15-55-13-0260__LED_.bmp		Not set	<input type="checkbox"/>
Correct	09_12-53-53-5440__LED_.bmp		Not set	<input type="checkbox"/>
Correct	10_15-39-01-1220__LED_.bmp		Not set	<input type="checkbox"/>

You can check the image on the **Measurement image preview** screen of Setting optimization.

Display image

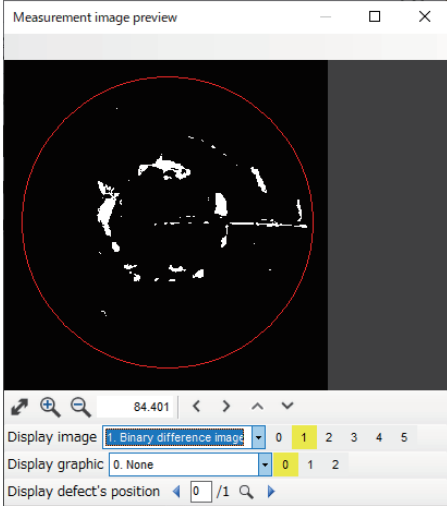
Item	Description
Measurement image	<p>Input image (the image to inspect)</p> 
Binary difference image	<p>For <i>Grayscale difference image</i>, an image in which pixels with a difference greater than or equal to the Difference value are white, and pixels with no difference greater than the Difference value are black.</p> <p>This image are used in combination with Labeling and Precise Defect to inspect features and defect levels for things such as rectangles.</p> 

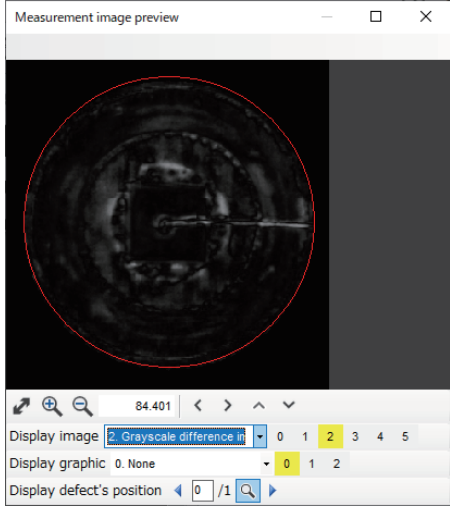
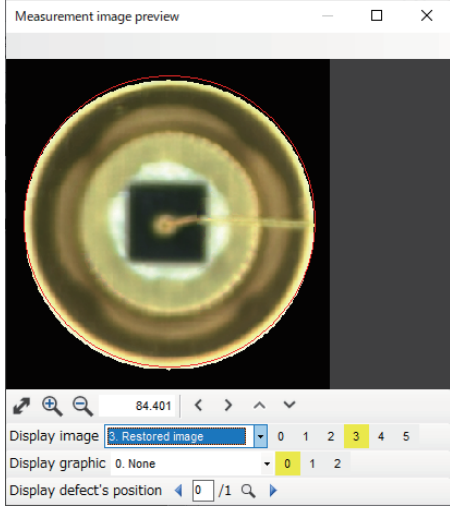
Item	Description
<p>Grayscale difference image</p>	<p>Image in which the pixel value is the density difference between <i>Measurement image</i> and <i>Restored image</i>. This image are used in combination with Labeling and Precise Defect to inspect features and defect levels for things such as rectangles.</p> 
<p>Restored image</p>	<p>Image in which defects are removed from <i>Measurement image</i> using the Trained model. It is used to check the features included in the Trained model when defects are undetected.</p> 

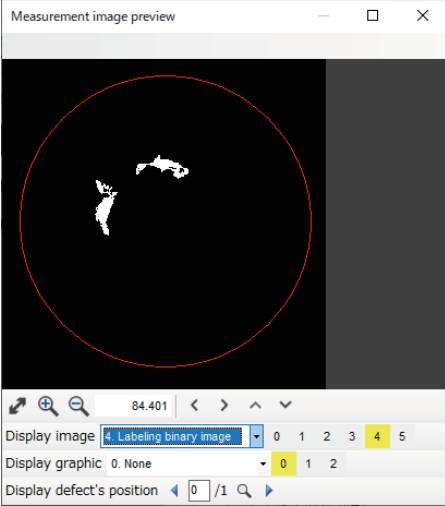
Item	Description
Labeling binary image	<p>Image in which pixels that belong to labels outside the <i>Extraction area</i> are made black by performing the labeling processing on the <i>Binary difference image</i> according to the <i>Filling up holes</i> and <i>Mode</i> settings.</p> 

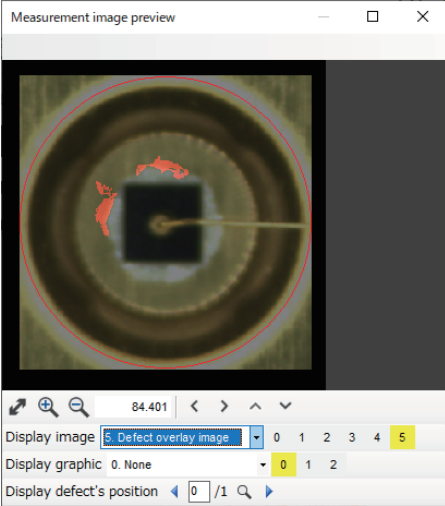
Defect overlay image	<p>Image in which the <i>Labeling binary image</i> is superimposed on the <i>Measurement image</i>. The Defect overlay color setting can be changed on the <i>Input parameters</i> tab.</p> 
----------------------	--

Display graphic

Item	Description
None	-

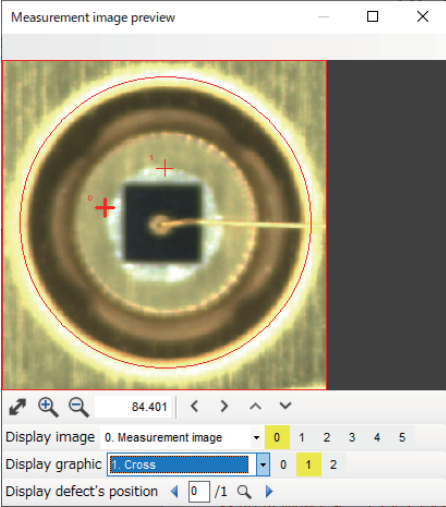
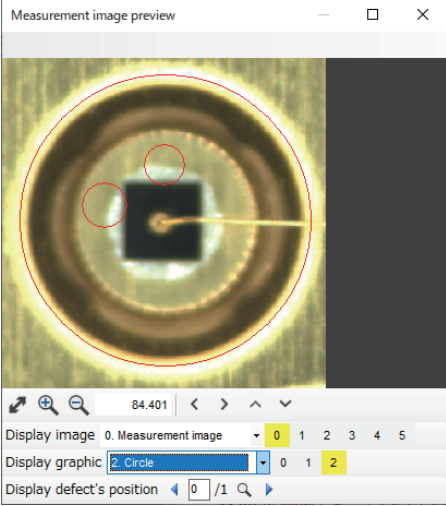
Item	Description
Cross	<p>Image in which a crosshair cursor is superimposed on the detected defect position.</p> 
Circle	<p>Image in which a circle is superimposed on the detected defect position.</p> 

Display defect's position

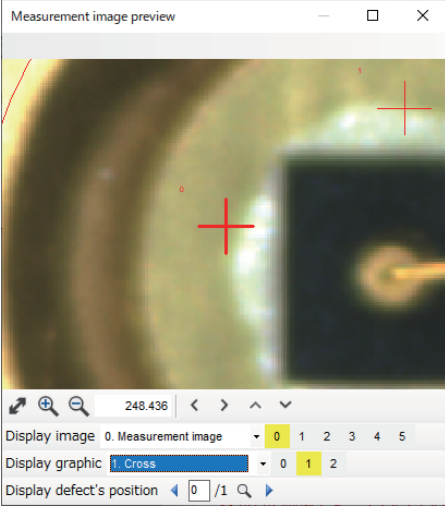
Item	Description
0 to Number of defects detected minus 1	<p>The specified detection position is displayed in the center of the Measurement image preview screen.</p>  <p>Click the arrow icon (↶) to return to the whole view.</p>

- 4 Select the pattern to be reflected in the measurement parameters and click **OK** in the **Optimization result confirmation** dialog.
When you click **OK** in the **Confirm optimization result** dialog, the parameter values of the selected pattern are reflected in the measurement parameters. The **Judgment condition** will be the default value.

- **If a False detection occurs for the OK image: Add a Training image.**

If a False detection occurs for the OK image, an appropriate OK image is added as a training image from the Optimization results.

- 1 Check the images to be added as Training images based on the optimization result score of OK image.
Add the images with the highest scores to the Training image.
The higher the score, the more characteristics of the image that differ from the current trained model.

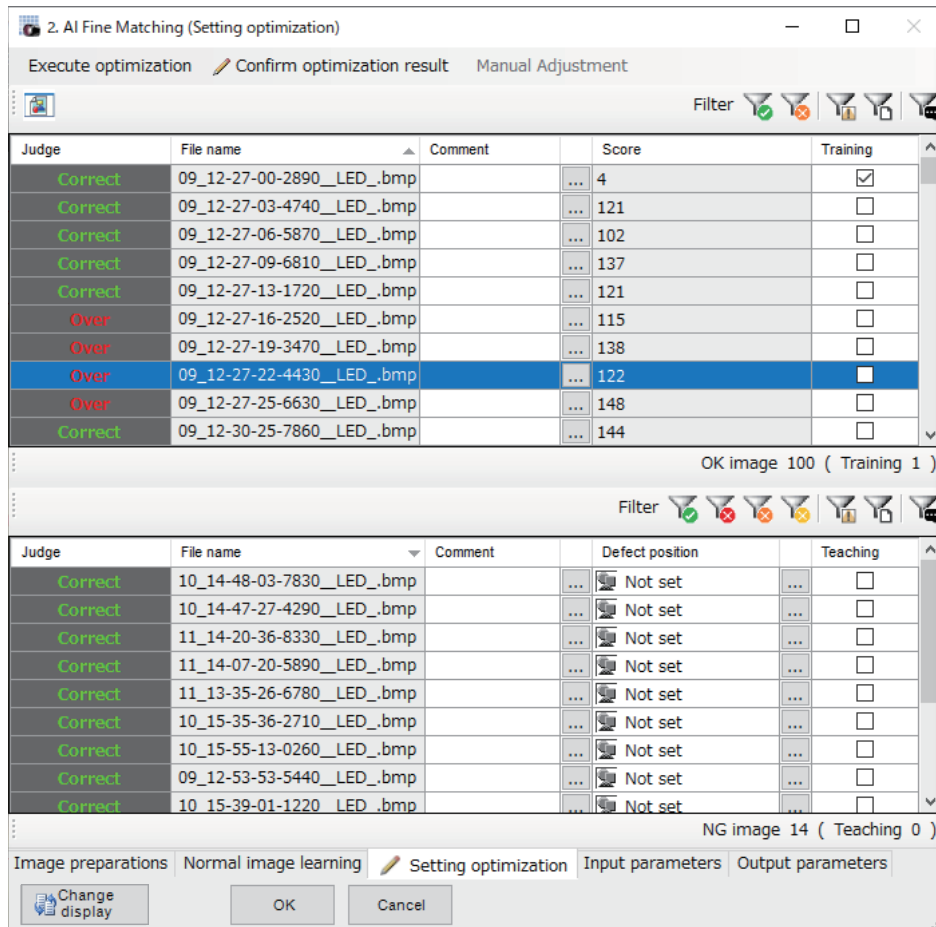

2 Once you have decided which Training images to add, start Learning again.
Refer to 2-36-3 *Normal image learning* on page 2-585.

3 After Training, run Optimization again.
Refer to 2-36-4 *Setting optimization* on page 2-593.

- **If Defect detection cannot be performed on the defect position to be detected in an NG image: Use that defect position in Optimization.**

If the defect cannot be detected at the Defect position to be detected in the NG image, the defect position is selected and optimization is performed

1 For the NG image for which you want to specify the Defect position, click the  icon for the Defect position to set it.
Refer to *Defect position setting* on page 2-581.

2 Check *Teaching* for the image on which the Defect position is set and execute optimization.
Refer to *Execute optimization* on page 2-596.

- **If Defect detection cannot be performed on the defect position to be detected in an NG image: Adjust measurement parameters. [Manual Adjustment]**

1 Click the **Manual Adjustment**

The *Manual Adjustment* dialog are displayed.

- 2 On the *Setting optimization* screen, select the result row for which no defects were detected.
- 3 Adjust the input parameters and click *Test Measurement* in the *Manual Adjustment* dialog. Make adjustments until defects are detected. The *Output parameters* are updated. Refer to 2-36-5 *Input Parameters (AI Fine Matching)* on page 2-610, 2-36-6 *Output parameters (AI Fine Matching)* on page 2-614.
- 4 If there are multiple images for which no defects were detected, continue repeating Steps 2 and 3. You can also click *Batch measurement* to perform re-measurement for all images. The result of the batch re-measurement is displayed in *Batch measurement result*.

2-36-5 Input Parameters (AI Fine Matching)

On the setting screen, click the **Input parameters** tab to display a list of measurement parameters. Set the input parameters. You can change parameter values and assign variables

Measurement

Set the conditions for measurement.

Image Subtraction

Setting Item	Setting value [Factory default]	Description
Trained model's file name	-	Select the trained model file to use. The measurement process is performed on the Measurement region that was set in the Trained model when Normal image learning was performed.
Defect brightness (monochrome image only)	<ul style="list-style-type: none"> • [Light and Dark] • Light • Dark 	Select the lightness of the defect you wish to extract (in relation to its background). If you want to detect both light and dark defects, select <i>Light and Dark</i> .
Normalization	<ul style="list-style-type: none"> • ON • [OFF] 	Select whether to perform normalization according to the lightness of image when training. If <i>ON</i> is selected, even if the lightness of the entire image changes, matching is performed after correcting the density, making it less susceptible to lighting fluctuations. If you perform normalization on a measurement object that has little or no pattern, the overall lightness will change, and you will not be able to perform measurement correctly.
Boundary inspection		
Active	<ul style="list-style-type: none"> • [ON] • OFF 	When <i>ON</i> , defects near the boundary where the color changes can also be detected. Contours that are the same as the contours of the model image are not judged as defects. Select this when inspecting for defects that appear on the boundary, such as chipping. Within the pixel range of a Contour \pm Boundary level image, scratches in a different direction from the contours of the model image are detected. When <i>OFF</i> , boundary parts are excluded from inspection. Although this will help prevent mis-detections due to any shifting of the measured object position, defects near the boundary cannot be detected. The number of pixels near the boundary to exclude from inspection is set by Boundary level .
Boundary level	0 to 9 [3]	Sets the degree to which boundary variations are absorbed in pixels. The role this plays differs depending on whether Boundary inspection is enabled.
Difference	0 to 255 [50]	Set the reference gradation level when taking the difference between the restored OK image and the measured image. Pixels that have a difference equal to or greater than the Difference judgment value are converted to white. All others are converted to black. Only the defects converted to white will be measured.
High sensitivity defect extraction	<ul style="list-style-type: none"> • [ON] • OFF 	When <i>ON</i> , small defects can be detected. Select <i>OFF</i> if noise is erroneously detected.

**Precautions for Correct Use**

When a variable is assigned to the **Trained model's file name** and used, a measurement time delay may occur during measurement execution.

Labeling

Setting Item	Setting value [Factory default]	Description
Filling up holes	<ul style="list-style-type: none"> • ON • [OFF] 	Select how to process the part surrounding the defect. When set to <i>ON</i> , it will be processed as the defect.

Setting Item	Setting value [Factory default]	Description
Mode	<ul style="list-style-type: none"> • 4-Neighbor • [8-Neighbor] 	Specify the conditions to use for defects. <ul style="list-style-type: none"> • 4-Neighbor: The contiguous parts at the top, bottom, left and right of the target pixel are processed as the same defect. • 8-Neighbor: Parts in the diagonal direction are added to the contiguous parts at the top, bottom, left and right of the target pixel to be processed as the same defect.
Extraction area	[0] to [999,999,999.9999]	Set the range of the area to be extracted as a defect.
Label No.	[0] to 2,499	Set the label number for the defect displayed in the measurement results. The defect numbers are sorted in descending order of area.

Judgement condition

Set the judgement conditions for measurement results.

Setting Item	Setting value [Factory default]	Description
Count	0 to 9,999 [0] to [0]	Set the number range for OK.
Defect area	[0] to [999,999,999.9999]	Set the range of Areas judged as OK.
Defect position X	[-99,999.9999] to [99,999.9999]	Set the range of X Coordinates judged as OK.
Defect position Y	[-99,999.9999] to [99,999.9999]	Set the range of Y Coordinates judged as OK.

Options

Setting Item	Setting value [Factory default]	Description
Working folder	-	Saves temporary data for Normal image learning and Setting optimization . If left blank, use RAMDisk as the Working folder.
Fixed phrase of Comment	-	Set the text to be displayed with this button. Text up to the line feed is registered as one fixed phrase.

Output

Select how to handle the output as the measurement result. Change this item as needed. Normally, the factory default values can be used.



Precautions for Correct Use

After setting up the measurement parameters, changing the output parameters will cause measurement results to vary accordingly. If the output parameters have been changed, set the measurement parameters again or try performing Setting optimization.

Setting item	Setting value [Factory default]	Description
Output coordinates	<ul style="list-style-type: none"> • [After scroll] • Before scroll 	As measurement results, select whether to output coordinate values to external devices before or after the position deflection correction is applied.
Calibration	<ul style="list-style-type: none"> • ON • [OFF] 	Select whether to reflect the calibration in the values output to the external device as measurement results. <ul style="list-style-type: none"> • ON: Output the coordinates converted into actual dimensions. • OFF: Output the camera coordinate values.
Reflect to overall judgment	<ul style="list-style-type: none"> • [ON] • OFF 	Enables choosing whether or not the judgement results of this processing unit is reflected in the scene overall judgment.



Additional Information

For output coordinates and calibration, refer to *Appendixes Measurement Mechanism Handling Coordinates* in the *Vision System FH/FHV Series User's Manual (Cat. No. Z365)*.

Output image

Setting Item	Setting value [Factory default]	Description
Active	<ul style="list-style-type: none"> • ON • [OFF] 	When ON , the image type specified in Image kind becomes the measurement image of the processing unit in the flow after this processing unit.
Image kind	<ul style="list-style-type: none"> • [Binary difference image] • Grayscale difference image • Restored image • Labelling binary image 	<ul style="list-style-type: none"> • Binary difference image: For <i>Grayscale difference image</i>, an image in which pixels with a difference greater than or equal to the Difference value are white, and pixels with no difference greater than the Difference value are black. This image are used in combination with Labeling and Precise Defect to inspect features and defect levels for things such as rectangles. • Grayscale difference image: Image in which the pixel value is the density difference between <i>Measurement image</i> and <i>Restored image</i>. This image are used in combination with Labeling and Precise Defect to inspect features and defect levels for things such as rectangles. • Restored image: Image in which defects are removed from <i>Measurement image</i> using the Trained model. It is used to check the features included in the Trained model when defects are undetected. • Labelling binary image Image in which pixels that belong to labels outside the <i>Extraction area</i> are made black by performing the labeling processing on the <i>Binary difference image</i> according to the <i>Filling up holes</i> and <i>Mode</i> settings.
Create labeling binary image	<ul style="list-style-type: none"> • ON • [OFF] 	Select whether to generate a labeling binary image. If ON is selected, a labeling binary image can be used as the output image, but the measurement processing time will be longer than when OFF is selected.

Display image

Setting Item	Setting value [Factory default]	Description
Defect overlay color	<ul style="list-style-type: none"> • [Red] • Green • Blue 	You can set the display color of the <i>Defect overlay image</i> .

2-36-6 Output parameters (AI Fine Matching)

On the setting screen, click the **Output parameters** tab to display a list of Output parameters. Display the measurement results that can be output. You can assign variables for parameters. The following values can be output using processing items related to result output. It is also possible to reference measurement values from calculation expressions and other processing units.

Measurement items	Character string	Description
Judge	JG	Judgment result 0: No judgment (unmeasured) 1: Judgment result OK -1: Judgment result NG -10: Error (image format mismatch) -11: Error (unregistered model) -12: Error (insufficient memory) -20: Error (other errors)
Count	DA	Output the number of defects detected.
Defect area	AR	Defect area of defect selected by <i>Label No.</i> Output the defect with the largest surface area if <i>Label No.</i> is the default value.
Defect position X	X	Defect position of defect selected by <i>Label No.</i>
Defect position Y	Y	Output the position of the defect with the largest surface area if <i>Label No.</i> is the default value.

2-36-7 Key Points for Test Measurement and Adjustment (AI Fine Matching)

The following content is displayed in the *Detail result* area as text.

Displayed item	Description
Judge	Judgment result 0: No judgment (unmeasured) 1: Judgment result OK -1: Judgment result NG -10: Error (image format mismatch) -11: Error (unregistered model) -12: Error (insufficient memory) -20: Error (other errors)
Quantity	Number of defects
Defect area	Defect area
Defect coordinate X	X Coordinate of measured defect position
Defect coordinate Y	Y coordinate of measured defect position

The image specified in the Sub-image number in the image display setting is displayed in the *Image Display* area.

Sub-image number	Description of image to be displayed
0	Measurement image Label No. of defect
1	Binary difference image Label No. of defect For <i>Grayscale difference image</i> , an image in which pixels with a difference greater than or equal to the Difference value are white, and pixels with no difference greater than the Difference value are black. This image are used in combination with Labeling and Precise Defect to inspect features and defect levels for things such as rectangles.
2	Grayscale difference image Label No. of defect Image in which the pixel value is the density difference between <i>Measurement image</i> and <i>Restored image</i> . This image are used in combination with Labeling and Precise Defect to inspect features and defect levels for things such as rectangles.
3	Restored image Label No. of defect Image in which defects are removed from <i>Measurement image</i> using the Trained model. It is used to check the features included in the Trained model when defects are undetected.
4	Labeling binary image Label No. of defect Image in which pixels that belong to labels outside the <i>Extraction area</i> are made black by performing the labeling processing on the <i>Binary difference image</i> according to the <i>Filling up holes</i> and <i>Mode</i> settings.
5	Defect overlay image Label No. of defect Image in which the <i>Labeling binary image</i> is superimposed on the <i>Measurement image</i> .
20	Measurement image Circle around Defect position
21	Binary difference image Circle around Defect position
22	Grayscale difference image Circle around Defect position
23	Restored image Circle around Defect position
24	Labeling binary image Circle around Defect position
25	Defect overlay image Circle around Defect position
30	Measurement image Circle around all Defect position
31	Binary difference image Circle around all Defect position
32	Grayscale difference image Circle around all Defect position

Sub-image number	Description of image to be displayed
33	Restored image Circle around all Defect position
34	Labeling binary image Circle around all Defect position
35	Defect overlay image Circle around all Defect position

Key Points for Adjustment (AI Fine Matching)

Adjust the setting parameters referring to the following points.

● When the measurement results are unstable

Parameter to be adjusted	Remedy
Measurement parameter	Due to a factor such as "variations in the position of the inspection object", it is possible that parts other than those with a defect are detected near the boundary between the inspection object and the background. Increase the Boundary level .
	It is possible that parts other than those with a defect have been detected due to a factor such as "brightness variations between measurement images". Set Normalization to ON.
Measurement region	If the position of the image is corrected using Position Compensation, a Position Compensation failure has caused the trained model in the measurement region to include either a "non-inspection part" or a "part outside the image". This invalid data has either been generated or included in measurement. Adjust the settings of the measurement processing items referenced by Position Compensation so that "only the inspection target part" is included in the Measurement region.
Trained model	If no defect is detected, check the Restored image. If defects remain in the Restored image, features of the defects may have been included in the Trained model. Check the images used for Normal image learning, remove any images that may be close to that of defective product, and try performing Normal image learning again.

● When you fail to Learning

Parameter to be adjusted	Remedy
Image preparations, Normal image learning	If the error message "Failed to perform training. No training image selected." appears, no learning image is selected. Select one or more learning images.
	If the error message "Failed to perform training. No training image found in specified path." appears, a reference error may have occurred in the learning images. Check the image reference method.
	If the error message "Failed to perform training. Inconsistent training image format." appears, the selected learning images may contain a mixture of monochrome and color images. Consistently use one or the other image format.
	If the error message "Failed to perform training. Inconsistent training image size." appears, the selected learning images may contain a mixture of multiple resolution images. Consistently use one image resolution.

Parameter to be adjusted	Remedy
Measurement region	<p>If the error message "Training failed because the figure for the measurement area has not been set." appears, the figure for the measurement area has not been set. Set the figure for the measurement area.</p> <p>If the error message "Training failed because the size of the measurement area figure is larger than the upper limit." appears, set the size of the figure for the measurement area to 2,448 x 2,048 or less.</p> <p>If the error message "Training failed because the size of the measurement area figure is smaller than the lower limit." appears, set the size of the figure for the measurement area to 128 x 128 or more.</p>
-	<p>Failed to prepare training images. The following are possible causes.</p> <ul style="list-style-type: none"> • Insufficient memory for work folder path • The work folder path is write-protected <p>" appears, the work folder may have not be created because the work folder is the default value (RAMDisk) causing insufficient memory, the external storage is write-protected, etc. Check the status of the save destination and ensure the available free space, etc.</p>
-	<p>If the error message "Failed to save trained model. The following are possible causes.</p> <ul style="list-style-type: none"> • Insufficient memory for the Save destination. • The Save destination is write-protected. <p>" appears, check the save destination and ensure the available free space, etc.</p>
-	<p>If the error message "Failed to perform learning processing. Insufficient memory." appears, perform the learning processing again.</p>

● When you run out of memory during Learning

Parameter to be adjusted	Remedy
Options	Change the path to the Working folder. (The default Save destination is RAM-Disk.)

● When the measurement result is NG (model not registered) even though the trained model is set.

Parameter to be adjusted	Remedy
-	The external storage set for Trained model save destination may not be recognized. Check that the external storage device is correctly inserted and that no cable has become disconnected.

● When you fail to perform Optimization

Parameter to be adjusted	Remedy
Image preparations tab	If the error message “Failed to perform optimization. Either OK image or NG image does not exist. Set both OK images and NG images in the Image preparations tab. appears, one or more OK or NG images may not be selected. Select one or more OK or NG images.
	If the error message “Failed to perform Optimization. No image in the specified path.” appears, a reference error may have occurred in the OK or NG images. Check the image reference method.
	If the error message “Failed to perform Optimization. Inconsistent image formats.” appears, the selected OK or NG images may contain a mixture of monochrome and color images. Consistently use one or the other image format.
	If the error message “Failed to perform Optimization. Inconsistent image sizes.” appears, the selected OK or NG images may contain a mixture of multiple resolution images. Consistently use one image resolution.
	If the error message “Failed to perform optimization. The following are possible causes. <ul style="list-style-type: none"> • Insufficient memory for work folder path • The work folder path is write-protected ” appears, the work folder may have not be created because the work folder is the default value (RAMDisk) causing insufficient memory, the external storage is write-protected, etc. Check the status of the save destination and ensure the available free space, etc.

2-36-8 External reference data (AI Fine Matching)

No.	Data name	Data ident	Set/Get	Data range
None	Trained model's file name	filterParam.learning-DataFileName	Set/Get	-
None	Normalization	filterParam.normalizationEnabled	Set/Get	0:OFF, 1:ON
None	Boundary inspection Active	filterParam.boundaryInspection.enabled	Set/Get	0:OFF, 1:ON
None	Boundary inspection Boundary level	filterParam.boundaryInspection.level	Set/Get	0 to 9
None	High sensitivity defect extraction	filterParam.sensitivityModeEnabled	Set/Get	0:OFF, 1:ON
None	Defect brightness (monochrome image only)	filterParam.defect-Brightness	Set/Get	0: Light and Dark, 1: Light, 2: Dark
None	Difference	filterParam.difference	Set/Get	0 to 255
None	Filling up holes	measureParam.fillin-gUpHolesEnabled	Set/Get	0:OFF, 1:ON
None	Mode	measureParam.neighborhood-Mode	Set/Get	0: 4-neighbor, 1: 8-neighbor
None	Extraction area (Lower)	measureParam.ex-tractionArea.lower	Set/Get	0 to 999,999,999.9999

No.	Data name	Data ident	Set/Get	Data range
None	Extraction area (Upper)	measureParam.extractionArea.upper	Set/Get	0 to 999,999,999.9999
None	Label No.	measureParam.labelNo	Set/Get	0 to 2,499
None	Working folder	workFolderName	Set/Get	-
None	Count (Lower)	judgeParam.count.lower	Set/Get	0 to 9,999
None	Count (Upper)	judgeParam.count.upper	Set/Get	0 to 9,999
None	Defect area (Lower)	judgeParam.defectArea.lower	Set/Get	0 to 999,999,999.9999
None	Defect area (Upper)	judgeParam.defectArea.upper	Set/Get	0 to 99,9999,999.9999
None	Lower limit of defect position X	judgeParam.defectX.lower	Set/Get	-99,999.9999 to 99,999.9999
None	Upper limit of defect position X	judgeParam.defectX.upper	Set/Get	-99,999.9999 to 99,999.9999
None	Lower limit of defect position Y	judgeParam.defectY.lower	Set/Get	-99,999.9999 to 99,999.9999
None	Upper limit of defect position Y	judgeParam.defectY.upper	Set/Get	-99,999.9999 to 99,999.9999
None	Fixed phrase of Comment	fixedCommentList	Set/Get	-
None	Output coordinates	outputCoordinate	Set/Get	0: After scroll, 1: Before scroll
None	Calibration	calibrationEnabled	Set/Get	0: OFF, 1: ON
None	Reflect to overall judgement	overallJudgeEnabled	Set/Get	0: ON, 1: OFF
None	Output image Active	outputImage.enabled	Set/Get	0:OFF, 1:ON
None	Output image Image type	outputImage.type	Set/Get	0: Binary difference image, 1: Grayscale difference image, 2: Restored image, 3: Labeling binary image
None	Create labeling binary image	imageData.labelingBinaryImageEnabled	Set/Get	0:OFF, 1:ON
None	Defect overlay color	displayImage.displayOverlayColor	Set/Get	0:Red, 1:Green 2:Blue
None	Judge	judge	Get only	0: No judgment (unmeasured), 1: Judgment result OK, -1: Judgment result NG, -10: Error (image format mismatch), -11: Error (unregistered model), -12: Error (insufficient memory), -20: Error (other errors)
None	Count	count	GET only	0 to 9,999
None	Defect area	defectArea	Get only	0 to 999,999,999.9999
None	Defect position X	defectX	Get only	-99,999.9999 to 99,999.9999
None	Defect position Y	defectY	Get only	-99,999.9999 to 99,999.9999

3

Compensate Image

This chapter describes how to apply positional compensation for measurement objects on the input image to measure accurately.

3-1	Position Compensation	3-3
3-1-1	Region Settings (Position Compensation)	3-4
3-1-2	Scroll Method (Position Compensation)	3-5
3-1-3	Key Points for Test Measurement and Adjustment (Position Compensation).....	3-6
3-1-4	Measurement Results for Which Output Is Possible (Position Compensation).....	3-6
3-1-5	External Reference Tables (Position Compensation)	3-7
3-2	Filtering	3-9
3-2-1	Filtering Parameters (Filtering)	3-10
3-2-2	Region Settings (Filtering)	3-12
3-2-3	External Reference Tables (Filtering)	3-13
3-3	Background Suppression	3-14
3-3-1	Filter Settings (Background Suppression)	3-15
3-3-2	Region Settings (Background Suppression).....	3-16
3-3-3	Measurement Results for Which Output Is Possible (Background Suppression)	3-16
3-3-4	External Reference Tables (Background Suppression)	3-17
3-4	Brightness Correct Filter	3-19
3-4-1	Filter Settings (Brightness Correct Filter).....	3-20
3-4-2	Region Settings (Brightness Correct Filter)	3-21
3-4-3	External Reference Tables (Brightness Correct Filter)	3-22
3-5	Color Gray Filter	3-24
3-5-1	Filter Settings (Color Gray Filter)	3-24
3-5-2	External Reference Tables (Color Gray Filter).....	3-26
3-6	Extract Color Filter	3-28
3-6-1	Color Specification (Extract Color Filter).....	3-28
3-6-2	Region Settings (Extract Color Filter)	3-31
3-6-3	Output Image (Extract Color Filter).....	3-31
3-6-4	Key Points for Test Measurement and Adjustment (Extract Color Filter).....	3-31
3-6-5	Measurement Results for Which Output Is Possible (Extract Color Filter) ...	3-31
3-6-6	External Reference Tables (Extract Color Filter)	3-32
3-7	Anti Color Shading	3-35
3-7-1	Filter Setting (Anti Color Shading)	3-35
3-7-2	Region Settings (Anti Color Shading)	3-37

3-7-3	Key Points for Test Measurement and Adjustment (Anti Color Shading)	3-37
3-7-4	Measurement Results for Which Output Is Possible (Anti Color Shading) ...	3-38
3-7-5	External Reference Tables (Anti Color Shading)	3-38
3-8	Stripes Removal Filter II	3-40
3-8-1	Filter Setting (Stripes Removal Filter II).....	3-41
3-8-2	Region Settings (Stripes Removal Filter II).....	3-43
3-8-3	Key Points for Test Measurement and Adjustment (Stripes Removal Filter II)	3-43
3-8-4	External Reference Tables (Stripes Removal Filter II).....	3-44
3-9	Polar Transformation	3-45
3-9-1	Region Settings (Polar Transformation).....	3-45
3-9-2	Key Points for Test Measurement and Adjustment (Polar Transformation) ..	3-47
3-9-3	Measurement Results for Which Output Is Possible (Polar Transformation)	3-47
3-9-4	External Reference Tables (Polar Transformation).....	3-47
3-10	Trapezoidal Correction	3-49
3-10-1	Conversion Method (Trapezoidal Correction).....	3-49
3-10-2	Region Settings (Trapezoidal Correction).....	3-55
3-10-3	Key Points for Test Measurement and Adjustment (Trapezoidal Correction)	3-55
3-10-4	Measurement Results for Which Output Is Possible (Trapezoidal Correction).....	3-55
3-10-5	External Reference Tables (Trapezoidal Correction).....	3-56
3-11	Machine Simulator	3-58
3-11-1	Settings Flow (Machine Simulator)	3-58
3-11-2	Machine Setting (Machine Simulator).....	3-59
3-11-3	Actual Setting (Machine Simulator)	3-60
3-11-4	Movement Setting (Machine Simulator).....	3-61
3-11-5	Key Points for Test Measurement and Adjustment (Machine Simulator).....	3-62
3-11-6	Measurement Results for Which Output Is Possible (Machine Simulator) ...	3-63
3-11-7	External Reference Tables (Machine Simulator)	3-64
3-12	Image Subtraction	3-66
3-12-1	Settings Flow (Image Subtraction).....	3-66
3-12-2	Operation Mode (Image Subtraction)	3-67
3-12-3	Model (Image Subtraction)	3-68
3-12-4	Disp. Image Sub. (Image Subtraction).....	3-69
3-12-5	Color (Image Subtraction).....	3-70
3-12-6	Key Points for Adjustment (Image Subtraction).....	3-71
3-12-7	Measurement Results for Which Output Is Possible (Image Subtraction)....	3-71
3-12-8	External Reference Tables (Image Subtraction)	3-72
3-13	Advanced Filter	3-73
3-13-1	Settings Flow (Advanced Filter).....	3-74
3-13-2	Filtering Settings (Advanced Filter).....	3-75
3-13-3	Region Settings (Advanced Filter)	3-118
3-13-4	Output Image Settings (Advanced Filter).....	3-118
3-13-5	Key Points for Test Measurement and Adjustment (Advanced Filter)	3-119
3-13-6	Measurement Results for Which Output Is Possible (Advanced Filter)	3-121
3-13-7	External Reference Tables (Advanced Filter)	3-121
3-14	Panorama	3-137
3-14-1	Camera Arrangement (Panorama)	3-140
3-14-2	Image Combination (Panorama).....	3-141
3-14-3	Key Points for Test Measurement and Adjustment (Panorama).....	3-144
3-14-4	Measurement Results for Which Output Is Possible (Panorama)	3-145
3-14-5	External Reference Tables (Panorama).....	3-145

3-1 Position Compensation

The positional deviation of measurement objects can be compensated using measured values held by other processing units. Compare the measured coordinates with the reference coordinates of the applicable processing unit, and move the image by the amount of the difference.

Used in the Following Case

Even with different positions for the same measurement object, correct measurement can still be performed by compensating the position of the input image. There is no need to reposition the measurement object itself.

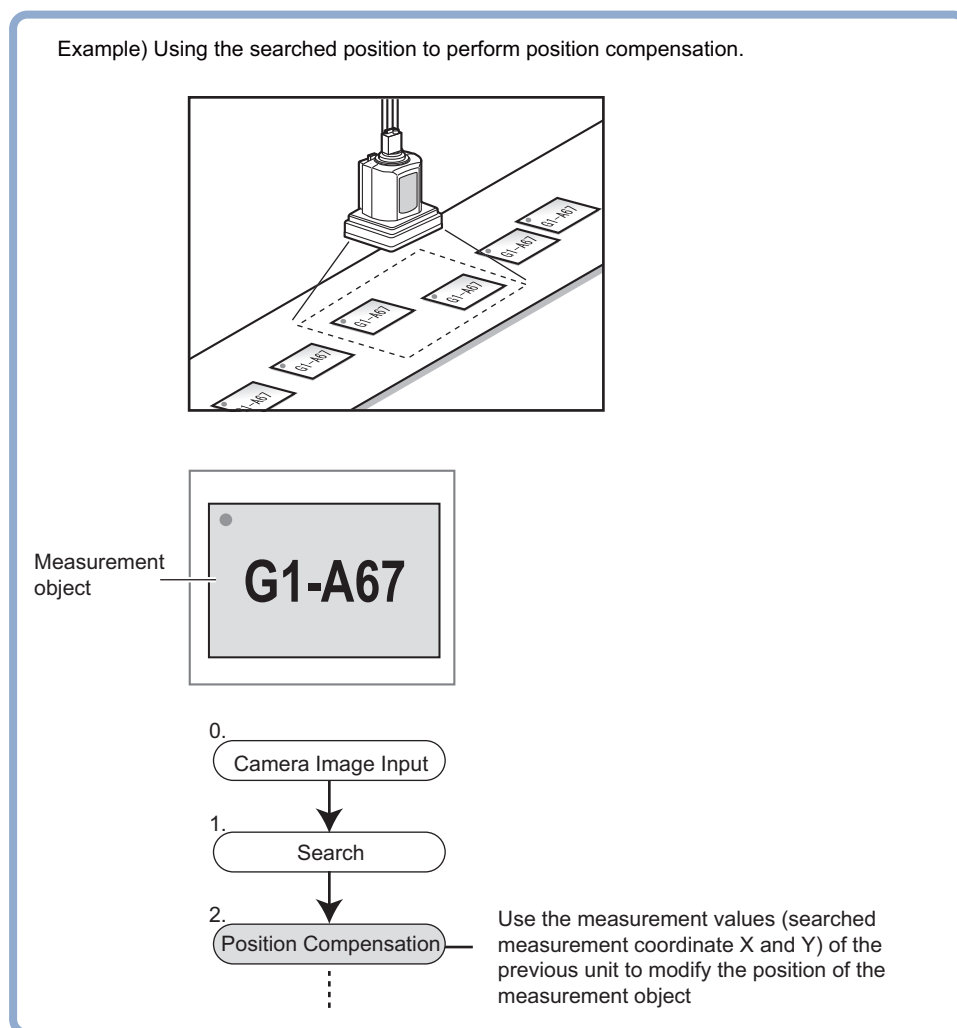

Precautions for Correct Use

- Processing is different for color images and monochrome images. When the camera type used in the previous setup was changed to color or monochrome type, perform the settings again.
- In the measurement flow, if the processing unit that generates the calibration data is set after the processing unit that corrects the image, the output coordinates that can be acquired by the processing unit after the processing unit that generates the calibration data are only the coordinates after image correction.

Processing Units That can be Combined with Position Compensation

Position Compensation compensates positions according to measured values (coordinates) from the immediately preceding processing unit. Combining the following processing unit(s) with Position Compensation is effective.

Processing unit type	Processing item name
Processing units performing search or matching (Hereafter, <i>Search processing unit</i>)	<ul style="list-style-type: none"> • 2-1 <i>Search</i> on page 2-8 • 2-3 <i>Flexible Search</i> on page 2-39 • 2-5 <i>ECM Search</i> on page 2-67 • 2-33 <i>OCR</i> on page 2-498
Processing units detecting edge positions (Hereafter, <i>Edge position processing unit</i>)	<ul style="list-style-type: none"> • 2-12 <i>Edge Position</i> on page 2-178 • 2-14 <i>Scan Edge Position</i> on page 2-202
Processing units detecting the center of gravity (Hereafter, <i>Processing unit for gravity center detection</i>)	<ul style="list-style-type: none"> • 2-20 <i>Gravity and Area</i> on page 2-297 • 2-21 <i>Labeling</i> on page 2-317



Precautions for Correct Use

- When the position correction method (**Method**) is set to *1 unit scroll*, *2 unit scroll*, the Position Compensation will not be performed correctly if units other than the above unit(s) are present immediately before the **Position correction** unit within the scene.
- For processing units used in combination with Position correction, set **Calibration** to *OFF* in **Output parameter**.
- The position correction method causes some processing items to be NG when areas outside the image are included within the region.
(Edge Position / Number of Edge Pins / Fine Matching / Defects and Contamination / High-precision Defects and Contamination Detection / Area Gravity Center / Labeling / Sophisticated Labeling+ / Color Average and Deviation / Scan Edge Position / Scan Edge Width / Circular Shape Angle Acquisition)

3-1-1 Region Settings (Position Compensation)

When position compensation is applied, the position is shifted by exactly the amount of the compensation, then measurement is performed. Restricting the region in which the image is moved can shorten the processing time.

- 1** In the Item tab area, click **Region setting**.
- 2** Click **Edit**.
The *Figure setting* area is displayed.
- 3** Use the Drawing tools to specify the measurement region.
- 4** Click **OK** in the *Figure setting* area.
 - **OK**: Changes the settings and returns to the previous menu.
 - **Cancel**: Changes are discarded and returns to the previous menu.
 - **Apply**: Updates the settings without leaving the current window.

3-1-2 Scroll Method (Position Compensation)

Set the compensation method for position compensation.

- 1 In the Item Tab area, click **Scroll method**.
- 2 Set each parameter.

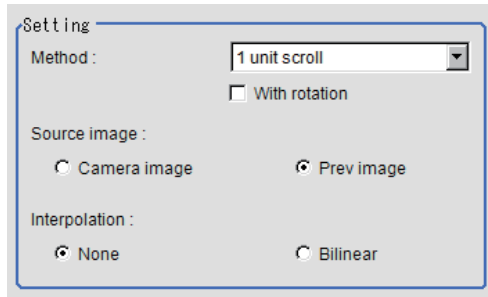

Setting item	Setting value [Factory default]	Description
Method	<ul style="list-style-type: none"> • [1 unit scroll] • 2 unit scroll • Calculation • Reset scroll 	<ul style="list-style-type: none"> • 1 unit scroll: This performs a position correction by referring to the coordinates measured with the Search processing unit*¹ or Edge Position processing unit immediately before the Position correction (automatic processing unit). This moves the image by the difference between the measured coordinates and the reference coordinates of the referring search processing unit or edge position processing unit. • 2 unit scroll: This performs a position correction by referring to the coordinates measured with the search processing unit or edge position processing unit*¹ immediately before or two units before the Position correction (automatic processing unit). • Calculation: Sets whichever position correction you prefer. Set the reference coordinates and measurement coordinates. • Reset scroll: The image for the immediately preceding image input (Camera Image Input/Camera Switching) is displayed. When Position correction has been performed, the status returns to that from before position correction. If Filtering or Color Gray Filter had been performed, the original image with Filtering or Color Gray Filter released is displayed.
With rotation	<ul style="list-style-type: none"> • Checked • [Unchecked] 	When <i>1 unit scroll</i> or <i>2 unit scroll</i> is selected as the <i>setting method</i> , place a check when executing position correction in the rotation direction in addition to the X and Y directions.

Setting item	Setting value [Factory default]	Description
Source image	<ul style="list-style-type: none"> • Camera image • [Prev. unit image] 	<ul style="list-style-type: none"> • Camera image: The camera input image that has not been subject to filtering is subject to correction as is. • Prev. unit image: Images to which filtering and position correction processing are applied in units even before the Position correction being set are the targets.
Interpolation	<ul style="list-style-type: none"> • [None] • Bilinear 	<ul style="list-style-type: none"> • None: Position correction is performed in pixels. • Bilinear: This option ties multiple points with a line to find a desired approximate value. The image will become smoother.

*1. Refer to *Processing Units That can be Combined with Position Compensation* on page 3-4.

- 3** When you choose the *Calculation* option. Using expressions, specify the *Reference* and *Position* which are used to determine the position compensation. Differences between the respective values in the *Reference* and *Position* areas give the amount of position compensation to be performed. Refer to *4-3-3 Layout of Setting Expression Window (Calculation)* on page 4-12.

3-1-3 Key Points for Test Measurement and Adjustment (Position Compensation)

The image specified in the Sub-image number in the image display setting is displayed in the *Image Display* area.

Sub-image number	Description of image to be displayed
0	Image after compensation
1	Image before compensation

3-1-4 Measurement Results for Which Output Is Possible (Position Compensation)

The following values can be output using processing items related to result output. It is also possible to reference measurement values from calculation expressions and other processing units.

Measurement items	Character string	Description
Judge	JG	Judgment results 0: No judgment (unmeasured) 1: Judgment result OK -1: Judgment result NG -10: Error (image format mismatch) -11: Error (unregistered model) -12: Error (insufficient memory) -20: Error (other errors)
Scroll X	DX	Scroll X
Scroll Y	DY	Scroll Y
Scroll θ	DT	Position compensation θ
Position X	X	Meas. X coordinate
Position Y	Y	Meas. Y coordinate
Angle θ	TH	Angle θ
Ref. position X	SX	Ref. X coordinate
Ref. position Y	SY	Ref. Y coordinate
Reference angle θ	ST	Ref. angle

3-1-5 External Reference Tables (Position Compensation)

No.	Data name	Data ident	Set/Get	Data range
0	Judge	judge	Get only	0: No judgment (unmeasured), 1: Judgment result OK, -1: Judgment result NG, -10: Error (image format mismatch), -11: Error (unregistered model), -12: Error (insufficient memory), -20: Error (other errors)
5	Scroll X	moveX	Get only	-99,999.9999 to 99,999.9999
6	Scroll Y	moveY	Get only	-99,999.9999 to 99,999.9999
7	Scroll theta	moveAngl	Get only	-999.9999 to 999.9999
8	Position X	measPosX	Get only	0 to 99,999.9999
9	Position Y	measPosY	Get only	0 to 99,999.9999
10	Measurement theta	measAngl	Get only	-999.9999 to 999.9999
11	Reference X	stdPosX	Get only	-99,999.9999 to 99,999.9999
12	Reference Y	stdPosY	Get only	-99,999.9999 to 99,999.9999
13	Reference theta	stdAngl	Get only	-999.9999 to 999.9999
120	Interpolation	compensation	Set/Get	0: None, 1: Bilinear
121	Method	setupMode	Set/Get	0: 1 unit scroll, 1: 2 unit scroll, 2: Expression, 3: Re-set scroll
122	Scroll target	targetImage	Set/Get	0: Camera image 1: Prev. unit image
123	With rotation	rotation	Set/Get	0: OFF, 1: ON
124	Reference position X	setDataRefX	Set/Get	Exp. character string
125	Reference position Y	setDataRefY	Set/Get	Exp. character string
126	Reference angle	setDataRefAngl	Set/Get	Exp. character string

No.	Data name	Data ident	Set/Get	Data range
127	Measurement position X	setDataPosX	Set/Get	Exp. character string
128	Measurement position Y	setDataPosY	Set/Get	Exp. character string
129	Measurement angle	setDataAngl	Set/Get	Exp. character string
90,000	figure0 Count	figArea0_count	Set/Get	1
90,001	figure0 Type	figArea0_fig0_type	Set/Get	8: Rectangle
90,002	figure0 mode	figArea0_fig0_mode	Set/Get	0: OR
90,014	figure0 Rectangle Upper left position X	figArea0_fig0_box_X0	Set/Get	-99,999 to 99,999
90,015	figure0 Rectangle Upper left position Y	figArea0_fig0_box_Y0	Set/Get	-99,999 to 99,999
90,016	figure0 Rectangle Lower right position X	figArea0_fig0_box_X1	Set/Get	-99,999 to 99,999
90,017	figure0 Rectangle Lower right position Y	figArea0_fig0_box_Y1	Set/Get	-99,999 to 99,999
90,099	figure0 Update	figArea0_update	Set only	1: Update

3-2 Filtering

Process the images acquired from cameras to make them easier to measure.

Used in the Following Case

- Cutting out unnecessary background images to exclude them from the measurement region:

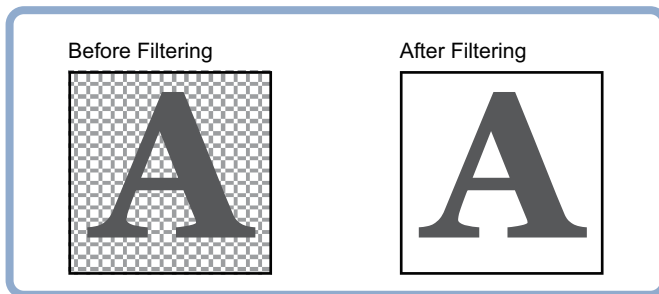

- When noise is to be removed:

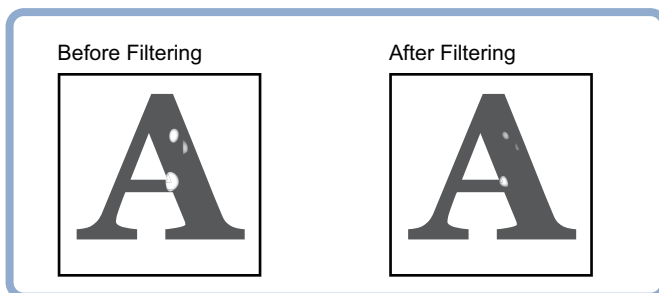

- When the edges of marks you want to find cannot be found even though other edges have been clearly extracted:

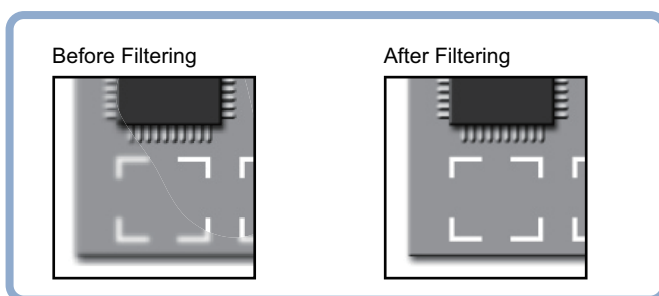

Precautions for Correct Use

Processing is different for color images and monochrome images. When the camera type used in the previous setup was changed to color or monochrome type, perform the settings again.

3-2-1 Filtering Parameters (Filtering)

Treat the images loaded from the camera in order to make them easier to measure. You can select from 10 filtering methods to match the image state.

- 1 In the Item Tab area, click **Filter parameter**.
- 2 Set each item while checking the image.

Setting item	Setting value [Factory default]	Description
Display	<ul style="list-style-type: none"> • Through image • [Freeze image] 	<ul style="list-style-type: none"> • Through image: The latest image is always loaded from the camera and displayed. • Freeze image: The image loaded in the immediately preceding measurement is displayed.
Target for filtering	<ul style="list-style-type: none"> • [Camera image] • Previous image 	<ul style="list-style-type: none"> • Camera image Filtering is applied to the images input from the camera set before this unit (Filtering) in the scene. Filtering is not performed. • Previous image Filtering is applied to the images which have been processed by the Position correction and Filtering processing units set before this unit (Filtering) in the scene.
Order of filtering	<ul style="list-style-type: none"> • [Filtering → BGS] • BGS → Filtering 	Selects the sequence of background suppression filtering.
Filtering	<ul style="list-style-type: none"> • [OFF] • Weak smoothing • Strong smoothing • Dilate • Erosion • Median • Extract edges • Extract horizontal edges • Extract vertical edges • Enhance edges 	Selects the type of filtering. For details, refer to <i>Filtering Options and Examples on page 3-11</i> .
Mask size	<ul style="list-style-type: none"> • [3×3] • 5×5 	Selects whether to use information from several surrounding pixels. With <i>Filter size</i> , the larger the setting value, the more of the surrounding pixel variation that can be assimilated.
BGS level	0 to 255 [0] to [255]	While looking at the image, specify the upper and lower limits for RGB to suppress as the background. For details, refer to <i>Background Suppression Level on page 3-12</i> .

Filtering Options and Examples

Treat the images loaded from the camera in order to make them easier to measure.

Types of filtering	The problems to be treated	Filtering description	Example
Weak smoothing Strong smoothing	Small flecks on the measurement object	Makes flecks less visible	Makes stable searching possible and stable area measurement possible.
Dilate	Dark noise exists	This filtering removes dark noise by enlarging brighter areas.	Removing noise from measurement objects
Erosion	Brighter noise exists	This filtering removes brighter noise by shrinking brighter areas.	
Median	Small flecks on the measurement object	This filtering keeps the profile and weakens flecks.	Edge positioning (Accuracy is not reduced)
Extract edges	Due to a comparatively lower image contrast, defects are difficult to extract	Extracts the boundary lines of the image (light and shade).	Defect inspection
Extract vertical edges	Due to a comparatively lower image contrast, defects are difficult to extract	Extracts the boundary lines vertical to the image (light and shade).	
Extract horizontal edges	Due to a comparatively lower image contrast, defects are difficult to extract	Extracts the boundary lines horizontal to the image (light and shade).	
Enhance edges	The measurement object is blurry (due to changes such as lighting fluctuation).	Clearly delineates the boundary lines between the light and dark in the image.	Edge positioning

Notes on Filtering Setting

If filtering is applied to the image, the area around the image frame will become unstable. When the *Filtering* processing item has been set in the scene, note that measurement ranges such as *Region Setting* for other processing items should not include the area around the image frame.

The width not included in the measurement range will vary depending on the filter size setting.

- Filter size: 5×5

Set the width of two pixels around the image frame not to be included in the measurement range.

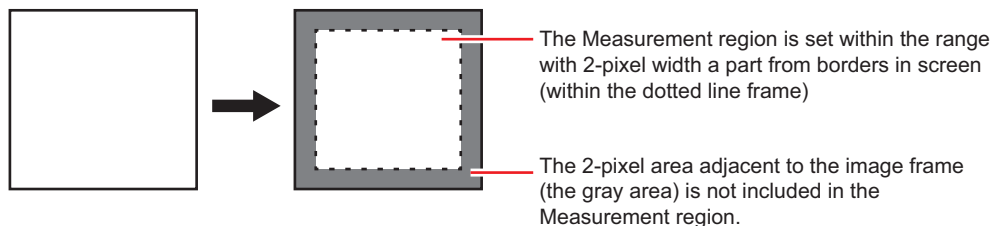

- Filter size: 3×3

Set the width of one pixel around the image frame not to be included in the measurement range.

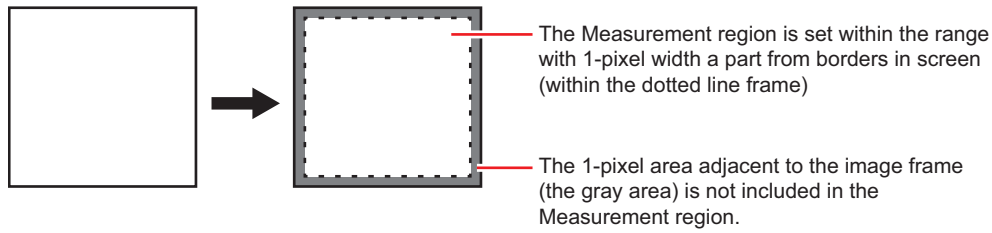

③ When a partial scan is used to limit the load range:

Set so as to not include the image loading range surroundings.

The width that will not be included in the measurement range is the same as the above. (In the following figure, filter size: 5×5).

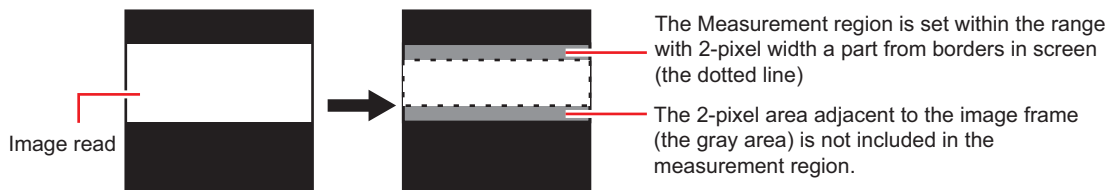

Background Suppression Level

Brightness is adjusted to the lower or upper limit when that of an image is below the lower limit or above the upper limit.

Example) lower limit: 100 upper limit: 220

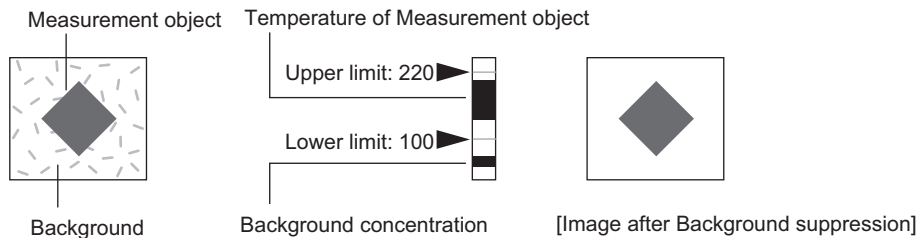

Only images with a density of 100 to 220 will be the measurement targets.

3-2-2 Region Settings (Filtering)

It is possible to target the entire screen, but restricting the range can shorten the processing time.

- 1** In the Item tab area, click **Region setting**.
- 2** Click **Edit**.
The *Figure setting* area is displayed.
- 3** Use the Drawing tools to specify the measurement region.
- 4** Click **OK** in the *Figure setting* area.
 - **OK**: Changes the settings and returns to the previous menu.
 - **Cancel**: Changes are discarded and returns to the previous menu.
 - **Apply**: Updates the settings without leaving the current window.

3-2-3 External Reference Tables (Filtering)

No.	Data name	Data ident	Set/Get	Data range
0	Judge	judge	Get only	0: No judgment (unmeasured), 1: Judgment result OK, -1: Judgment result NG, -10: Error (image format mismatch), -11: Error (unregistered model), -12: Error (insufficient memory), -20: Error (other errors)
120	Target	targetImage	Set/Get	0: Camera image 1: Prev. unit image
121	Filtering	filter	Set/Get	0 to 9
122	Order of filtering	order	Set/Get	0: Filtering -> BGS 1: BGS -> Filtering
123	Mask size	maskSize	Set/Get	0: 3x3, 1: 5x5
124	BGS level Min.	backLower	Set/Get	0 to 255
125	BGS level Max.	backUpper	Set/Get	0 to 255

3-3 Background Suppression

Specifying a brightness range to be used for measurements eliminates areas outside of the range as background.

Moreover, since the extracted range is converted to a value of 0 to 255, the contrast can be emphasized.

Used in the Following Case

Extracting a specific brightness range enables you to improve the image contrast or to eliminate unnecessary background.

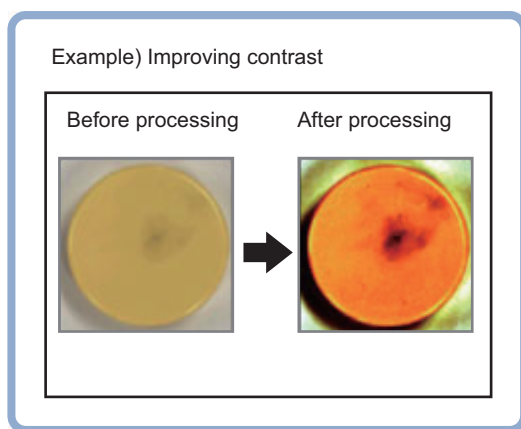

- Basic concept of background suppression:

Because input values from 0 to *Lower* are converted to level 0 and values from *Upper* to 255 are converted to level 255, the background in this range is eliminated.

Together with this, only *Lower* to *Upper* from the input values 0 to 255 are taken and those are converted to output values of 0 to 255, so the contrast within this range is emphasized.

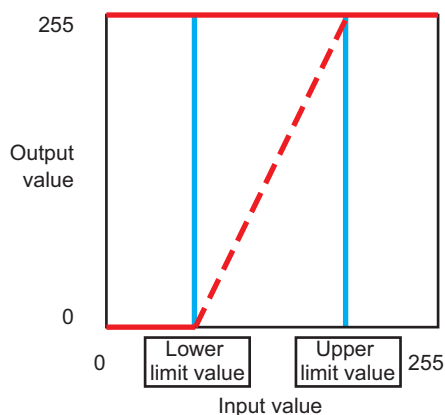

Precautions for Correct Use

Processing is different for color images and monochrome images. When the camera type used in the previous setup was changed to color or monochrome type, perform the settings again.

3-3-1 Filter Settings (Background Suppression)

This item sets the filter.

- 1 In the Item tab area, click **Filter**, and then click **Filter setting**.
- 2 In the *Display* area, click **Change display** to switch between camera image types.

Setting item	Setting value [Factory default]	Description
Display	<ul style="list-style-type: none"> • Through image • [Freeze image] 	<ul style="list-style-type: none"> • Through image: The latest image is always loaded from the camera and displayed. • Freeze image: The image loaded in the immediately preceding measurement is displayed.

- 3 Set the background suppression level.
There are two setting methods: specifying the section in the image to emphasize the contrast, specifying the extracting range with numeric values.
 - For color cameras:

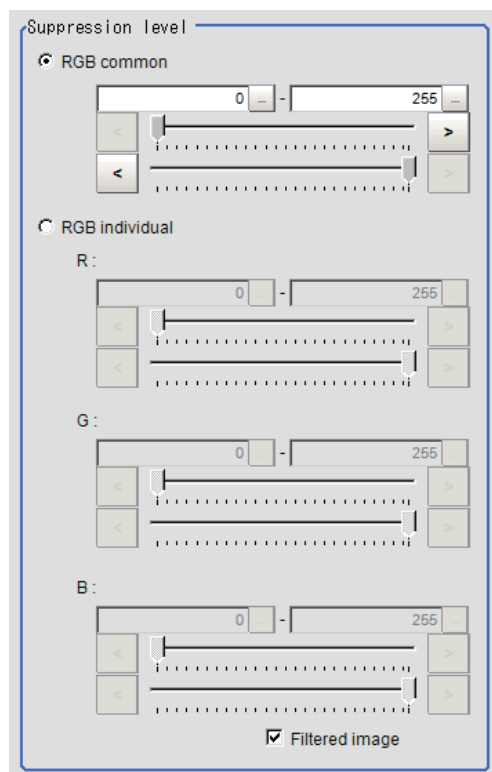

Setting item	Setting value [Factory default]	Description
Suppression level	<ul style="list-style-type: none"> • RGB common 0 to 255 • RGB individual 0 to 255 	<ul style="list-style-type: none"> • RGB common Sets the upper and lower values for the background suppression level. The range set from the minimum to the maximum values is converted to 0 to 255. • RGB individual Sets the upper and lower values for the background suppression level individually. The range set from the minimum to the maximum values is converted to 0 to 255.

- For monochrome cameras:

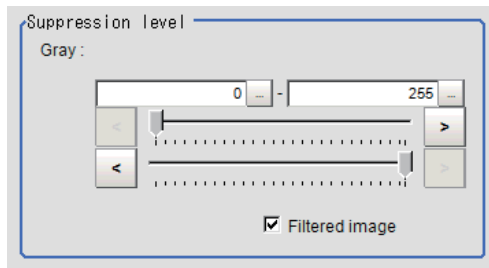

Setting item	Setting value [Factory default]	Description
Gray	0 to 255	The set range is converted to 0 to 255.

- 4 Set the display image as necessary.

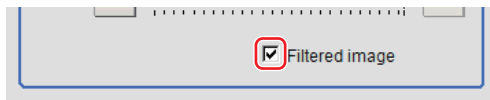

3-3-2 Region Settings (Background Suppression)

It is possible to target the entire screen, but restricting the range can shorten the processing time.

- 1 In the Item tab area, click **Region setting**.
- 2 Click **Edit**.
The *Figure setting* area is displayed.
- 3 Use the Drawing tools to specify the measurement region.
- 4 Click **OK** in the *Figure setting* area.
 - **OK**: Changes the settings and returns to the previous menu.
 - **Cancel**: Changes are discarded and returns to the previous menu.
 - **Apply**: Updates the settings without leaving the current window.

3-3-3 Measurement Results for Which Output Is Possible (Background Suppression)

The following values can be output using processing items related to result output. It is also possible to reference measurement values from calculation expressions and other processing units.

Measurement items	Character string	Description
Judge	JG	Judgment results 0: No judgment (unmeasured) 1: Judgment result OK -1: Judgment result NG -10: Error (image format mismatch) -11: Error (unregistered model) -12: Error (insufficient memory) -20: Error (other errors)

3-3-4 External Reference Tables (Background Suppression)

No.	Data name	Data ident	Set/Get	Data range
0	Judge	judge	Get only	0: No judgment (unmeasured), 1: Judgment result OK, -1: Judgment result NG, -10: Error (image format mismatch), -11: Error (unregistered model), -12: Error (insufficient memory), -20: Error (other errors)
121	Color setting mode	colorMode	Set/Get	0: RGB common 1: RGB individual
122	Lower limit for common colors	lowCommon	Set/Get	0 to 255
123	Upper limit for common colors	uppCommon	Set/Get	0 to 255
124	MIN R	lowRed	Set/Get	0 to 255
125	MAX R	uppRed	Set/Get	0 to 255
126	MIN G	lowGreen	Set/Get	0 to 255
127	MAX G	uppGreen	Set/Get	0 to 255
128	MIN B	lowBlue	Set/Get	0 to 255
129	MAX B	uppBlue	Set/Get	0 to 255
130	Lower limit for shading	lowGray	Set/Get	0 to 255
131	Upper limit for shading	uppGray	Set/Get	0 to 255
132	Filtered image	highContrastImage	Set/Get	0: Image prior to transfer 1: Image after transfer
200	Transfer source image number	srcImageNo	Set/Get	0 to 9
201	Transfer destination image number	destImageNo	Set/Get	0 to 9
6,002	Format	cameraColor	Set/Get	1: Monochrome camera 2: Color camera
90,000	figure0 Count	figArea0_count	Set/Get	1
90,001	figure0 Type	figArea0_fig0_type	Set/Get	8: Rectangle
90,002	figure0 mode	figArea0_fig0_mode	Set/Get	0: OR

No.	Data name	Data ident	Set/Get	Data range
90,014	figure0 Rectangle Upper left position X	figAr- ea0_fig0_box_X0	Set/Get	-99,999 to 99,999
90,015	figure0 Rectangle Upper left position Y	figAr- ea0_fig0_box_Y0	Set/Get	-99,999 to 99,999
90,016	figure0 Rectangle Lower right position X	figAr- ea0_fig0_box_X1	Set/Get	-99,999 to 99,999
90,017	figure0 Rectangle Lower right position Y	figAr- ea0_fig0_box_Y1	Set/Get	-99,999 to 99,999
90,099	figure0 Update	figArea0_update	Set only	1: Update

3-4 Brightness Correct Filter

The filter can be used to correct the effect of the material and shape of the lighting and the measurement object.

Used in the Following Case

This is used when the image is non-uniform due to the effect of the material and shape of the lighting and the measurement object.

• Brightness correction

Even if the brightness of the measurement object changes due to the impact of the surrounding environment, consistent measurement results can be obtained by applying correction to a certain brightness.

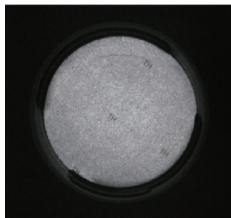

Dark input image

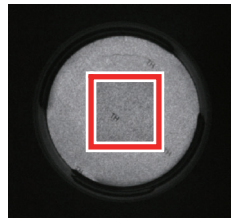

Brightness correction result

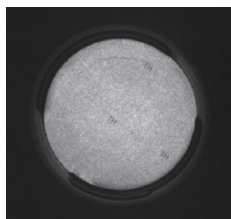

Bright input image

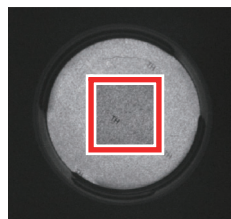

Brightness correction result

 Setting region

• Unevenness removal

If the image is uneven due to the influence of the shape, material, or the like of the measurement object, this function can be used to remove the unevenness and make defects easier to detect.

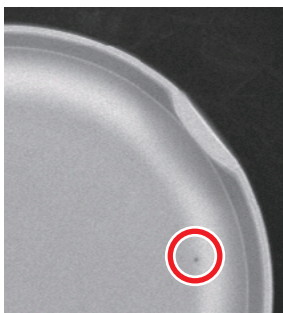

Input image

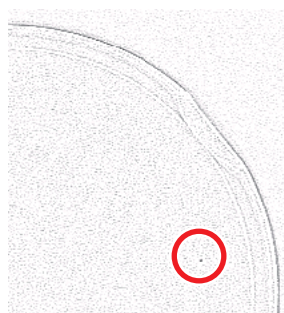

Unevenness removal



Precautions for Correct Use

- This processing item is specialized for monochrome images. When using a color camera, insert the *Color Gray Filter* processing item before this one. If a color image is input, this item becomes NG (incompatible image).
- Processing is different for color images and monochrome images. When the camera type used in the previous setup was changed to color or monochrome type, perform the settings again.

3-4-1 Filter Settings (Brightness Correct Filter)

This item sets the filter.

- 1 In the Item Tab area, click **Filter** and then click **Filter setting**.
- 2 In the *Display* area, click **Change display** to switch between camera image types. The displayed contents in the *Image display* area will be switched.

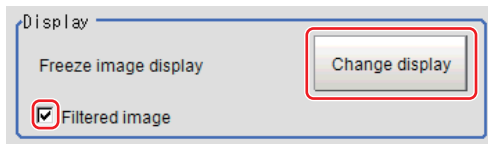

Setting item	Setting value [Factory default]	Description
Display	<ul style="list-style-type: none"> • Through image • [Freeze image] 	<ul style="list-style-type: none"> • Through image: The latest image is always loaded from the camera and displayed. • Freeze image: The image loaded in the immediately preceding measurement is displayed.
Filtered image	<ul style="list-style-type: none"> • [Checked] • Unchecked 	Unchecks this to display the original image.

- 3 Set the target image.

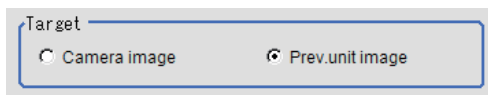

Setting item	Setting value [Factory default]	Description
Target	<ul style="list-style-type: none"> • Camera image • [Prev. unit image] 	<ul style="list-style-type: none"> • Camera image: The camera input image that has not been subject to filtering is subject to correction as is. • Prev. unit image: Images to which processing was applied in a processing unit prior to the Brightness Correct Filter being set are the targets.

- 4 Set the correction method.

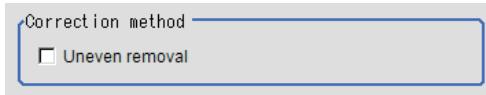

Setting item	Setting value [Factory default]	Description
Uneven removal	<ul style="list-style-type: none"> • Checked • [Unchecked] 	Places a check here, unevenness removal is performed in addition to brightness correction.

5 Specify the filtering setting (only for *Uneven removal*).

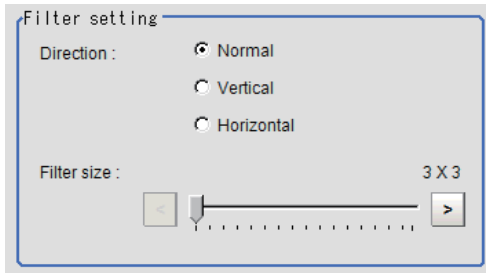

Setting item	Setting value [Factory default]	Description
Direction	<ul style="list-style-type: none"> • [Normal] • Vertical • Horizontal 	Usually, sets this to <i>Normal</i> . When the direction of change of the unevenness is one direction, select a perpendicular direction for that.
Filter size	3 to 255 [3]	Increases this value to fit the size of defects to extract. Only an odd value is acceptable.

6 Set the details.

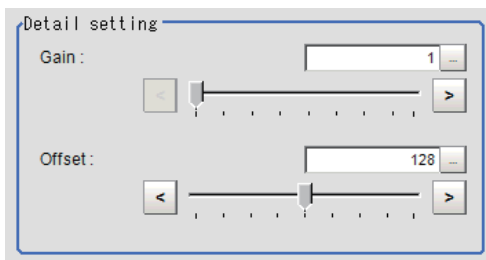

Setting item	Setting value [Factory default]	Description
Gain	1 to 63 [1]	Adjusts the contrast of an image after correction. Increasing the value emphasizes the concentration differences in images.
Offset	0 to 255 [128]	Adjusts the brightness of an image after correction. Increasing the value makes images brighter.

3-4-2 Region Settings (Brightness Correct Filter)

It is possible to target the entire screen, but restricting the range can shorten the processing time.

- 1** In the Item tab area, click **Region setting**.
- 2** Click **Edit**.
The *Figure setting* area is displayed.
- 3** Use the Drawing tools to specify the measurement region.
- 4** Click **OK** in the *Figure setting* area.
 - **OK**: Changes the settings and returns to the previous menu.
 - **Cancel**: Changes are discarded and returns to the previous menu.
 - **Apply**: Updates the settings without leaving the current window.

3-4-3 External Reference Tables (Brightness Correct Filter)

No.	Data name	Data ident	Set/Get	Data range
0	Judge	judge	Get only	0: No judgment (unmeasured), 1: Judgment result OK, -1: Judgment result NG, -10: Error (image format mismatch), -11: Error (unregistered model), -12: Error (insufficient memory), -20: Error (other errors)
120	Uneven removal(Method)	unevenRemoval	Set/Get	0: Without uneven removal (Brightness correction), 1: Uneven removal
121	Filter direction	direction	Set/Get	0: H&V, 1: Horizontal, 2: Vertical
122	Filter size	filterSize	Set/Get	3 to 255, N: Odd only
123	Gain	gain	Set/Get	1 to 63
124	Offset	offset	Set/Get	0 to 255
200	Conversion former image	srcImageNo	Set/Get	0 to 9
201	Destination image No.	destImageNo	Set/Get	0 to 9
202	Target image	targetImage	Set/Get	0: Camera image 1: Prev. unit image
203	display image	filteredImage	Set/Get	0: Display Input image 1: Display filtered image
90,000	figure0 Count	figArea0_count	Set/Get	1
90,001	figure0 Type	figArea0_fig0_type	Set/Get	8: Rectangle
90,002	figure0 mode	figArea0_fig0_mode	Set/Get	0: OR
90,014	figure0 Rectangle Upper left position X	figArea0_fig0_box_X0	Set/Get	-99,999 to 99,999
90,015	figure0 Rectangle Upper left position Y	figArea0_fig0_box_Y0	Set/Get	-99,999 to 99,999
90,016	figure0 Rectangle Lower right position X	figArea0_fig0_box_X1	Set/Get	-99,999 to 99,999

No.	Data name	Data ident	Set/Get	Data range
90,017	figure0 Rectangle Lower right position Y	figAr- ea0_fig0_box_Y1	Set/Get	-99,999 to 99,999
90,099	figure0 Update	figArea0_update	Set only	1: Update

3-5 Color Gray Filter

This item converts color images input from a color camera to monochrome ones.

Available filters are a *Primary color filter (RGB)*, *Complementary color filter (CMY)*, *Brightness filter*, and *HSV filter*.

This processing item does not accept monochrome images. If applied, the result will be *Judgement NG* (incompatible image).



Additional Information

The settings of processing items followed by this filter are the same ones as a monochrome camera is connected.

Used in the Following Case

When converting color images to monochrome images with specific colors emphasized:

Example) To obtain a monochrome image with the dark red area enhanced

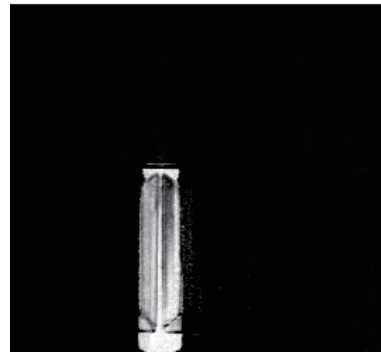

3-5-1 Filter Settings (Color Gray Filter)

This item sets the filter.

- 1 In the Item tab area, click **Filter**, and then click **Filter setting**.
- 2 In the *Display* area, click **Change display** to switch between camera image types. The displayed contents in the *Image display* area will be switched.

Setting item	Setting value [Factory default]	Description
Display	<ul style="list-style-type: none"> • Through image • [Freeze image] 	<ul style="list-style-type: none"> • Through image: The latest image is always loaded from the camera and displayed. • Freeze image: The image loaded in the immediately preceding measurement is displayed.

3 Select the type of filter in the *Filter type* area.



Setting item	Setting value [Factory default]	Description
Filter type	<ul style="list-style-type: none"> [RGB filter] HSV filter 	<ul style="list-style-type: none"> RGB filter: Specifies the color extraction range with R, G, B. HSV filter: Specifies the color extraction range with hue and color chroma.

③ When RGB is selected:

4 Select the type of color filter in *RGB filter* area.

When *Custom filter* is selected, set *Gain (Red)*, *Gain (Green)*, and *Gain (Blue)* as necessary.

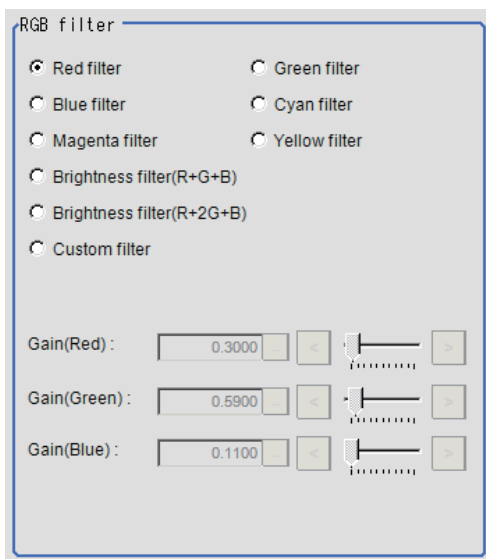

Setting item	Setting value [Factory default]	Description
RGB filter	<ul style="list-style-type: none"> [Red filter] Green filter Blue filter Cyan filter Magenta filter Yellow filter Brightness filter (R+G+B) Brightness filter (R+2G+B) Custom filter 	This item produces the same effects as using the selected optical filters.
Gain (Red)	0.0001 to 9.9999 [0.3000]	RGB gain values when processing with a custom filter. The density of the color component increases as the value increases. Enabled when <i>Custom filter</i> is selected for RGB filter.
Gain (Green)	0.0001 to 9.9999 [0.5900]	
Gain (Blue)	0.0001 to 9.9999 [0.1100]	

③ When HSV is selected:

5 Select the type of filter in the *HSV filter* area.

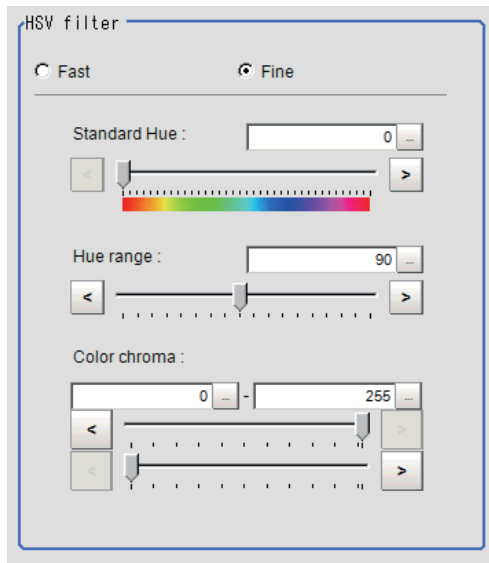

Setting item	Setting value [Factory default]	Description
HSV filter	<ul style="list-style-type: none"> Fast [Fine] 	<ul style="list-style-type: none"> Fast: The color extraction range is set only by hue. Fine: Extraction is set by standard hue, hue range, and color chroma.
Standard Hue	0 to 359 [0]	Decreases as the difference in hue from the standard hue (difference in tone) increases.
Hue range	10 to 180 [90]	Specifies the hue range (difference in tone) of the HSV filter. The hue difference is obtained by dividing the specified hue range into 255 sub-ranges with the standard hue as the center sub-range. the density of the hue outside the hue range is 0. Enabled when <i>Fine</i> is selected.
Color chroma	0 to 255 [0] to [255]	Specifies the upper and lower limits for saturation (vividness). Enabled when <i>Fine</i> is selected.

3-5-2 External Reference Tables (Color Gray Filter)

No.	Data name	Data ident	Set/Get	Data range
0	Judge	judge	Get only	0: No judgment (unmeasured), 1: Judgment result OK, -1: Judgment result NG, -10: Error (image format mismatch), -11: Error (unregistered model), -12: Error (insufficient memory), -20: Error (other errors)
100	Filter kind	kind	Set/Get	0: RGB filter, 1: HSV filter

No.	Data name	Data ident	Set/Get	Data range
101	RGB filter kind	kindColor	Set/Get	0: Red filter, 1:Green filter, 2: Blue filter, 3: Cyan filter, 4: Magenta filter, 5: Yellow filter, 6: Brightness filter (R+G+B), 7: Brightness filter (R+2G+B), 8: Custom filter
102	Gain(Red)	gainR	Set/Get	0.0001 to 9.9999
103	Gain(Green)	gainG	Set/Get	0.0001 to 9.9999
104	Gain(Blue)	gainB	Set/Get	0.0001 to 9.9999
105	HSV filter	kindColorGray	Set/Get	0: Fast, 1: Fine
106	Standard Hue	standardH	Set/Get	0 to 359
107	Hue range	hueRange	Set/Get	10 to 180
108	Upper Limit for Saturation	upperS	Set/Get	0 to 255
109	Lower Limit for Saturation	lowerS	Set/Get	0 to 255
200	Before conversion image	srcImageNo	Set/Get	0 to 9
201	After conversion image	destImageNo	Set/Get	0 to 9

3-6 Extract Color Filter

The color image is extracted by color. Up to 8 ranges can be set.
However, this processing item cannot be used with monochrome images.

Used in the Following Case

When extracting a target object with different color.

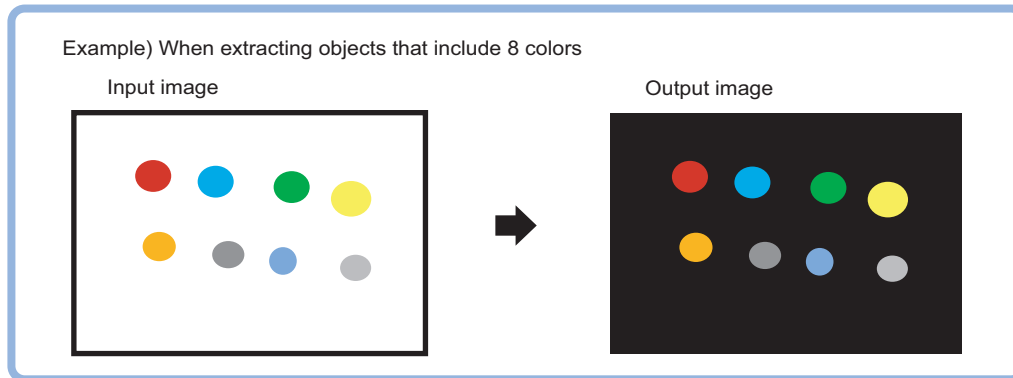

Precautions for Correct Use

Processing is different for color images and monochrome images. When the camera type used in the previous setup was changed to color or monochrome type, perform the settings again.

3-6-1 Color Specification (Extract Color Filter)



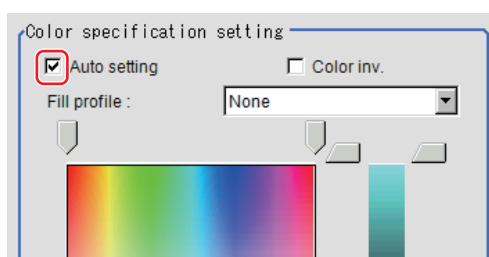

When connecting a color camera, specify the color to be measured. There are two specification methods: specifying the color to be extracted in the image or specifying the color with the hue, saturation, and brightness values.

This section describes how to specify colors in an image and gives an example of the procedure for finely adjusting with numeric input afterwards.

- 1** In the Item Tab area, click **Color setting**.
- 2** Place a check at *Auto setting*.
- 3** In the *Image display* area, specify the color range you want to detect by dragging the cursor from the upper left corner to the lower right corner of that area.
The color of the specified area is automatically set.



4 Select *Fill profile* as necessary.

Setting item	Setting value [Factory default]	Description
Fill profile	<ul style="list-style-type: none"> • [None] • Fill outline • Filling up holes 	<p>Selects the fill profile method.</p> <ul style="list-style-type: none"> • None The empty section in the center is not filled in. • Fill outline In the measurement region, the part between the extracted-color start point and end point in the X-axis direction is measured as having the extracted color. Since filling is applied only to the X-axis direction, the processing is faster than filling up holes. <div style="display: flex; justify-content: space-around; align-items: center;"> <div style="text-align: center;"> <p>Input image</p>  </div> <div style="text-align: center;"> <p>Image after filling up hole</p>  </div> </div> <ul style="list-style-type: none"> • Filling up holes The part surrounded by the extracted color, like a doughnut hole, is filled with the extracted color. <div style="display: flex; justify-content: space-around; align-items: center;"> <div style="text-align: center;"> <p>Input image</p>  </div> <div style="text-align: center;"> <p>Fill profile image</p>  </div> </div>

5 Finely adjust the hue, saturation, and brightness as necessary. Adjust either by adjusting on the color chart or by inputting numbers.

Setting item	Setting value [Factory default]	Description
H	0 to 359	Specify the color phase (difference of color hues).
S	0 to 255	Specify color saturation (difference of color saturation).
V	0 to 255	Specify the brightness (difference of brightness).
Auto setting	<ul style="list-style-type: none"> • Checked • [Unchecked] 	Specifying the color to be measured on the image automatically sets the hue, saturation, and brightness.
Color inv.	<ul style="list-style-type: none"> • Checked • [Unchecked] 	Everything other than the specified color becomes the measurement target.

- Color charts:

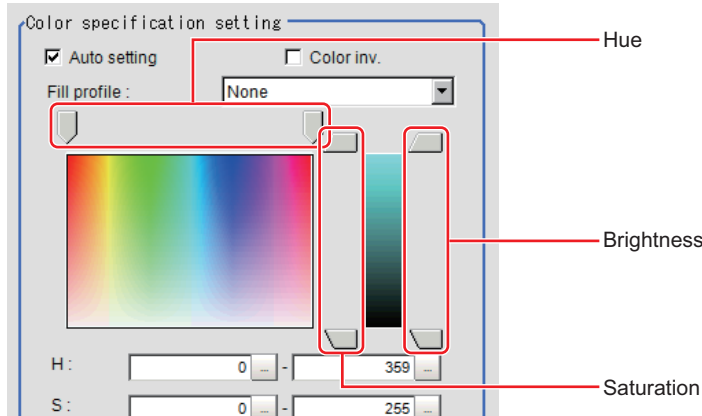

6 When specifying multiple colors, place a check at *More ranges of color extraction*.

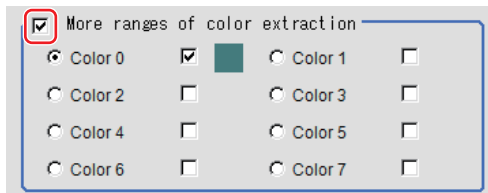

Setting item	Setting value [Factory default]	Description
More ranges of color extraction	<ul style="list-style-type: none"> Checked [Unchecked] 	Places a check at this allows you to set up to eight colors.

7 Set the display conditions for displayed images as necessary.

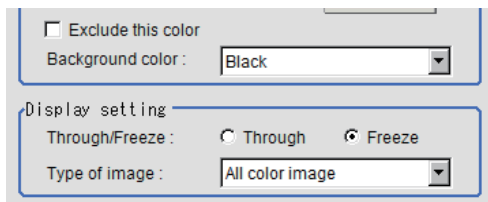

Setting item	Setting value [Factory default]	Description
Exclude this color	<ul style="list-style-type: none"> Checked [Unchecked] 	Places a check at this one excludes pixels within the set HSV range from color extraction. The priority order for the extraction is that the higher color extraction range numbers are given priority. This setting is disabled when <i>More ranges of color extraction</i> is unchecked.
Background color	<ul style="list-style-type: none"> [Black] White Red Green Blue 	The background part other than the extraction image is filled with the specified colors. The settable background colors depend on the display settings. When <i>Color selected image</i> is selected, the background color can be set for each selected color. When <i>All color image</i> is selected, the background color for color extraction range 0 is used.

Setting item	Setting value [Factory default]	Description
Through/Freeze	<ul style="list-style-type: none"> Through [Freeze] 	For <i>Through</i> , the latest image from the camera is always displayed, for <i>Freeze</i> , the image that was scanned in the immediately preceding measurement is displayed.
Type of image	<ul style="list-style-type: none"> Measurement image [All color image] color selected image Binary image 	Sets the state of the image to display.

3-6-2 Region Settings (Extract Color Filter)

Use a rectangle to specify the area where the model is searched. It is possible to target the entire screen, but restricting the range can shorten the processing time.

- 1** In the Item tab area, click **Region setting**.
- 2** Click **Edit**.
The *Figure setting* area is displayed.
- 3** Use the Drawing tools to specify the measurement region.
- 4** Click **OK** in the *Figure setting* area.
 - **OK**: Changes the settings and returns to the previous menu.
 - **Cancel**: Changes are discarded and returns to the previous menu.
 - **Apply**: Updates the settings without leaving the current window.

3-6-3 Output Image (Extract Color Filter)

Setting item	Setting value [Factory default]	Description
Output image setting	<ul style="list-style-type: none"> [Binary image] All color image 	Sets the state of the image to output.

3-6-4 Key Points for Test Measurement and Adjustment (Extract Color Filter)

The image specified in the Sub-image number in the image display setting is displayed in the *Image Display* area.

Sub-image number	Description of image to be displayed
0	Color extraction image
1	Measurement image

3-6-5 Measurement Results for Which Output Is Possible (Extract Color Filter)

The following values can be output using processing items related to result output. It is also possible to reference measurement values from calculation expressions and other processing units.

Measurement items	Character string	Description
Judge	JG	Judgment results 0: No judgment (unmeasured) 1: Judgment result OK -1: Judgment result NG -10: Error (image format mismatch) -11: Error (unregistered model) -12: Error (insufficient memory) -20: Error (other errors)

3-6-6 External Reference Tables (Extract Color Filter)

No.	Data name	Data ident	Set/Get	Data range
0	Judge	JG	Get only	0: No judgment (unmeasured), 1: Judgment result OK, -1: Judgment result NG, -10: Error (image format mismatch), -11: Error (unregistered model), -12: Error (insufficient memory), -20: Error (other errors)
120	Fill profile	fill	Set/Get	0: OFF, 1: Fill profile, 2: Filling up holes
121	Inverse area presence	invert	Set/Get	0: OFF, 1: ON
122	Image kind	imageKind	Set/Get	0: Measurement image, 1: All color image, 2: Selection color image, 3: Binary image
123	Multiple selections	multiSelect	Set/Get	0: Multiple selections disabled, 1: Multiple selections enabled
124	Output image	outputImage	Set/Get	0: Binary image 1: All color image
130+N×10 (N=0 to 7)	Usage flag	flag0 to flag7	Set/Get	0: Not used, 1: Used
131+N×10 (N=0 to 7)	OR/NOT setting	orNot0 to orNot7	Set/Get	0: OR, 1: NOT
132+N×10 (N=0 to 7)	Register the max. color hue	upperH0 to upperH7	Set/Get	0 to 359
133+N×10 (N=0 to 7)	Register the min. color hue	lowerH0 to lowerH7	Set/Get	0 to 359
134+N×10 (N=0 to 7)	Register the max. color saturation	upperS0 to upperS7	Set/Get	0 to 255
135+N×10 (N=0 to 7)	Register the min. color saturation	lowerS0 to lowerS7	Set/Get	0 to 255
136+N×10 (N=0 to 7)	Register the max. color brightness	upperV0 to upperV7	Set/Get	0 to 255

No.	Data name	Data ident	Set/Get	Data range
137+N×10 (N=0 to 7)	Register the min. color brightness	lowerV0 to lowerV7	Set/Get	0 to 255
138+N×10 (N=0 to 7)	Register the BG color	backGround0 to backGround7	Set/Get	0: Black, 1: White, 2: Red, 3: Green, 4: Blue
90,000	figure0 Count	figArea0_count	Set/Get	1 to 8
90,001	figure0 Type	figArea0_fig0_type	Set/Get	8: Rectangle, 16: Ellipse, 64: Circumference, 256: Wide arc, 512: Polygon
90,002	figure0 mode	figArea0_fig0_mode	Set/Get	0: OR, 1: NOT
90,014	figure0 Rectangle Upper left position X	figArea0_fig0_box_X0	Set/Get	-99,999 to 99,999
90,015	figure0 Rectangle Upper left position Y	figArea0_fig0_box_Y0	Set/Get	-99,999 to 99,999
90,016	figure0 Rectangle Lower right position X	figArea0_fig0_box_X1	Set/Get	-99,999 to 99,999
90,017	figure0 Rectangle Lower right position Y	figArea0_fig0_box_Y1	Set/Get	-99,999 to 99,999
90,018	figure0 Ellipse Center Position X	figArea0_fig0_ellipse_CX	Set/Get	-99,999 to 99,999
90,019	figure0 Ellipse Center Position Y	figArea0_fig0_ellipse_CY	Set/Get	-99,999 to 99,999
90,020	figure0 Ellipse RadiusX	figArea0_fig0_ellipse_RX	Set/Get	1 to 99,999
90,021	figure0 Ellipse RadiusY	figArea0_fig0_ellipse_RY	Set/Get	1 to 99,999
90,025	figure0 Circumference Center Position X	figArea0_fig0_circleW_X	Set/Get	-99,999 to 99,999
90,026	figure0 Circumference Center Position Y	figArea0_fig0_circleW_Y	Set/Get	-99,999 to 99,999
90,027	figure0 Circumference Radius	figArea0_fig0_circleW_R	Set/Get	0 to 99,999
90,028	figure0 Circumference Width	figArea0_fig0_circleW_W	Set/Get	0 to 99,999
90,034	figure0 Wide arc Center Position X	figArea0_fig0_arcW_X	Set/Get	-99,999 to 99,999
90,035	figure0 Wide arc Center Position Y	figArea0_fig0_arcW_Y	Set/Get	-99,999 to 99,999
90,036	figure0 Wide arc Radius	figArea0_fig0_arcW_R	Set/Get	0 to 99,999
90,037	figure0 Wide arc Start angle	figArea0_fig0_arcW_SA	Set/Get	-180 to 180
90,038	figure0 Wide arc End angle	figArea0_fig0_arcW_EA	Set/Get	-180 to 180
90,039	figure0 Wide arc Width	figArea0_fig0_arcW_W	Set/Get	0 to 99,999
90,040	figure0 Polygon Point Count	figArea0_fig0_polygon_count	Set/Get	3 to 10

No.	Data name	Data ident	Set/Get	Data range
90,041	figure0 Polygon Point1 Position X	figArea0_fig0_poly- gon_x0	Set/Get	-99,999 to 99,999
90,042	figure0 Polygon Point1 Position Y	figArea0_fig0_poly- gon_y0	Set/Get	-99,999 to 99,999
90,043	figure0 Polygon Point2 Position X	figArea0_fig0_poly- gon_x1	Set/Get	-99,999 to 99,999
90,044	figure0 Polygon Point2 Position Y	figArea0_fig0_poly- gon_y1	Set/Get	-99,999 to 99,999
90,045	figure0 Polygon Point3 Position X	figArea0_fig0_poly- gon_x2	Set/Get	-99,999 to 99,999
:	:	:	:	:
90,059	figure0 Polygon Point10 Position X	figArea0_fig0_poly- gon_x9	Set/Get	-99,999 to 99,999
90,060	figure0 Polygon Point10 Position Y	figArea0_fig0_poly- gon_y9	Set/Get	-99,999 to 99,999
90,099	figure0 Update	figArea0_update	Set only	1:Update
90,101	figure1 Type	figArea0_fig1_type	Set/Get	8: Rectangle, 16: Ellipse, 64: Circumference, 256: Wide arc, 512: Polygon
:	:	:	:	:
90,201	figure2 Type	figArea0_fig2_type	Set/Get	8: Rectangle, 16: Ellipse, 64: Circumference, 256: Wide arc, 512: Polygon
:	:	:	:	:
90,301	figure3 Type	figArea0_fig3_type	Set/Get	8: Rectangle, 16: Ellipse, 64: Circumference, 256: Wide arc, 512: Polygon
:	:	:	:	:
90,401	figure4 Type	figArea0_fig4_type	Set/Get	8: Rectangle, 16: Ellipse, 64: Circumference, 256: Wide arc, 512: Polygon
:	:	:	:	:
90,501	figure5 Type	figArea0_fig5_type	Set/Get	8: Rectangle, 16: Ellipse, 64: Circumference, 256: Wide arc, 512: Polygon
:	:	:	:	:
90,601	figure6 Type	figArea0_fig6_type	Set/Get	8: Rectangle, 16: Ellipse, 64: Circumference, 256: Wide arc, 512: Polygon
:	:	:	:	:
90,701	figure7 Type	figArea0_fig7_type	Set/Get	8: Rectangle, 16: Ellipse, 64: Circumference, 256: Wide arc, 512: Polygon
:	:	:	:	:
90,760	figure7 Polygon Point10 Position Y	figArea0_fig7_poly- gon_y9	Set/Get	-99,999 to 99,999

3-7 Anti Color Shading

This item eliminates color unevenness in images. Unevenness is eliminated either by converting the two specified colors toward the color midway between them or by converting one of the two specified colors to approach the other. However, this item is unavailable for monochrome images.

Used in the Following Case

This is used when a work that would be expected to have uniform color has a non-uniform image due to the effect of tilting, uneven paint, or the like.

By making the pixels of the two specified colors the same color, color irregularities and patterns on the workpiece are eliminated.

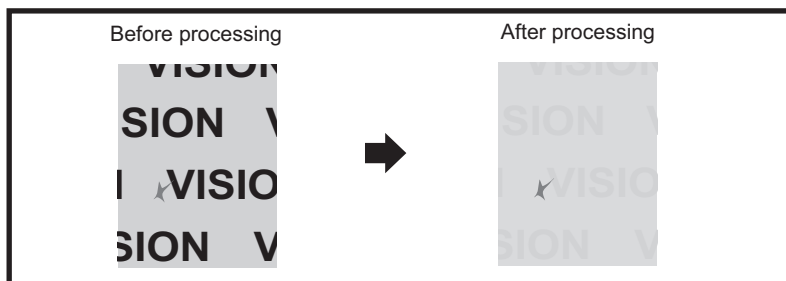

Precautions for Correct Use

Processing is different for color images and monochrome images. When the camera type used in the previous setup was changed to color or monochrome type, perform the settings again.

3-7-1 Filter Setting (Anti Color Shading)

This item sets the filter.

- 1** In the Item tab area, click **Filter**, and then click **Filter setting**.
- 2** In the *Display* area, click **Change display** to switch between camera image types. The display of the *Image display* area will be switched.

Setting item	Setting value [Factory default]	Description
Display	<ul style="list-style-type: none"> • Through image • [Freeze image] 	<ul style="list-style-type: none"> • Through image: The latest image is always loaded from the camera and displayed. • Freeze image: The image loaded in the immediately preceding measurement is displayed.

- 3** Enclose the part with color unevenness in the image. The image without the color unevenness is displayed.



- 4** Adjust the color, conversion direction, and level of Anti Color Shading as necessary. Two picked up colors are displayed at **Color 1** and **Color 2**. Moreover, fine adjustments are also possible with each value of R, G, and B or on the color charts.

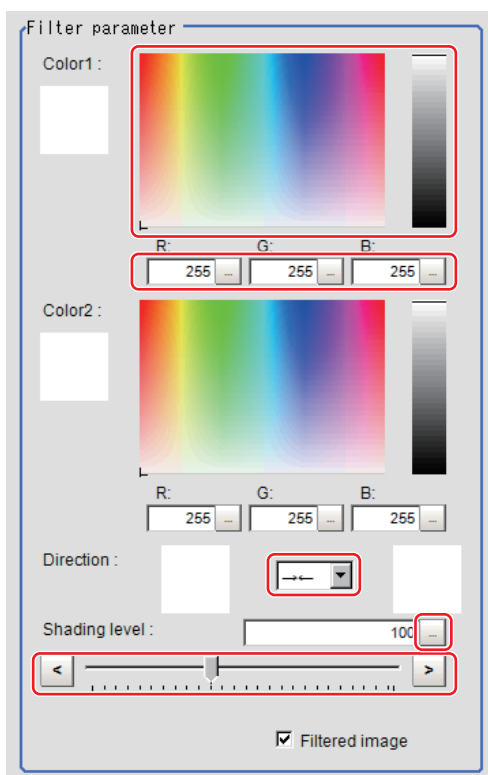

Setting item	Setting value [Factory default]	Description
Color 1	<ul style="list-style-type: none"> • R 0 to 255 [255] • G 0 to 255 [255] • B 0 to 255 [255] 	The most separate two colors are picked up from the specified region. The parts corresponding to these colors in the region are converted to the color midway between the two.
Color 2	<ul style="list-style-type: none"> • R 0 to 255 [255] • G 0 to 255 [255] • B 0 to 255 [255] 	

Setting item	Setting value [Factory default]	Description
Direction	<ul style="list-style-type: none"> • [→←] • → • ← 	Selects the conversion method from the set <i>Color 1</i> and <i>Color 2</i> . <ul style="list-style-type: none"> • →←: Color 1 and Color 2 are converted to the color midway between the two. • →: Color 1 is converted to Color 2 • ←: Color 2 is converted to Color 1
Shading level	0 to 255 [100]	Sets the level of suppressing color unevenness. The larger this value, the less the color unevenness.

5 Set the display image as necessary.



Setting item	Setting value [Factory default]	Description
Filtered image	<ul style="list-style-type: none"> • [Checked] • Unchecked 	Uncheck this to display the original image.

3-7-2 Region Settings (Anti Color Shading)

It is possible to target the entire screen, but restricting the range can shorten the processing time.

- 1** In the Item tab area, click **Region setting**.
- 2** Click **Edit**.
The *Figure setting* area is displayed.
- 3** Use the Drawing tools to specify the measurement region.
- 4** Click **OK** in the *Figure setting* area.
 - **OK**: Changes the settings and returns to the previous menu.
 - **Cancel**: Changes are discarded and returns to the previous menu.
 - **Apply**: Updates the settings without leaving the current window.

3-7-3 Key Points for Test Measurement and Adjustment (Anti Color Shading)

The following content is displayed in the *Detail result* area as text.

Displayed item	Description
Judge	Judgment results 0: No judgment (unmeasured) 1: Judgment result OK -1: Judgment result NG -10: Error (image format mismatch) -11: Error (unregistered model) -12: Error (insufficient memory) -20: Error (other errors)

3-7-4 Measurement Results for Which Output Is Possible (Anti Color Shading)

The following values can be output using processing items related to result output. It is also possible to reference measurement values from calculation expressions and other processing units.

Measurement items	Character string	Description
Judge	JG	Judgment results 0: No judgment (unmeasured) 1: Judgment result OK -1: Judgment result NG -10: Error (image format mismatch) -11: Error (unregistered model) -12: Error (insufficient memory) -20: Error (other errors)

3-7-5 External Reference Tables (Anti Color Shading)

No.	Data name	Data ident	Set/Get	Data range
0	Judge	judge	Get only	0: No judgment (unmeasured), 1: Judgment result OK, -1: Judgment result NG, -10: Error (image format mismatch), -11: Error (unregistered model), -12: Error (insufficient memory), -20: Error (other errors)
100	Specified color R1	colorR1	Set/Get	0 to 255
101	Specified color G1	colorG1	Set/Get	0 to 255
102	Specified color B1	colorB1	Set/Get	0 to 255
103	Specified color R2	colorR2	Set/Get	0 to 255
104	Specified color G2	colorG2	Set/Get	0 to 255
105	Specified color B2	colorB2	Set/Get	0 to 255
106	Direction	mode	Set/Get	0: Color 1 →← Color 2, 1: Color 1 → Color 2, 2: Color 1 ← Color 2
107	Shading level	evenLevel	Set/Get	0 to 255
108	Filtered image	evenImage	Set/Get	0: OFF, 1: ON
90,000	figure0 Count	figArea0_count	Set/Get	1
90,001	figure0 Type	figArea0_fig0_type	Set/Get	8: Rectangle

No.	Data name	Data ident	Set/Get	Data range
90,002	figure0 mode	figArea0_fig0_mode	Set/Get	0: OR
90,014	figure0 Rectangle Upper left position X	figAr- ea0_fig0_box_X0	Set/Get	-99,999 to 99,999
90,015	figure0 Rectangle Upper left position Y	figAr- ea0_fig0_box_Y0	Set/Get	-99,999 to 99,999
90,016	figure0 Rectangle Lower right position X	figAr- ea0_fig0_box_X1	Set/Get	-99,999 to 99,999
90,017	figure0 Rectangle Lower right position Y	figAr- ea0_fig0_box_Y1	Set/Get	-99,999 to 99,999
90,099	figure0 Update	figArea0_update	Set only	1: Update

3-8 Stripes Removal Filter II

This item stably extracts only defects by eliminating striped patterns or other background.

Used in the Following Case

When eliminating vertical or horizontal stripes from target objects

• Thin stripe pattern suppression filter

○ When the filter size is larger than the stripes and the defects are larger than the filter size, vertical filter stripes can be removed.

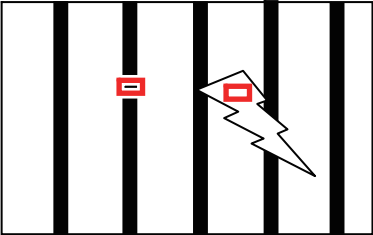

Filter shape (size)

✗ If the filter size is smaller than the stripes, the stripes cannot be removed.

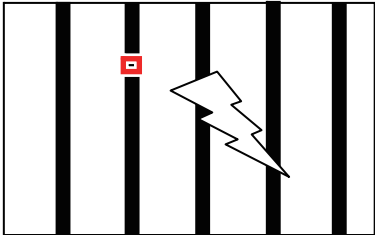

Defect

• Thick stripe pattern suppression filter

○ If defects are larger than the filter size and smaller than the stripe width, the stripes can be removed.

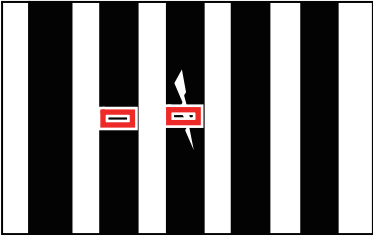

Filter shape (size)

✗ If the filter size is larger than the stripe width, the stripes cannot be removed.

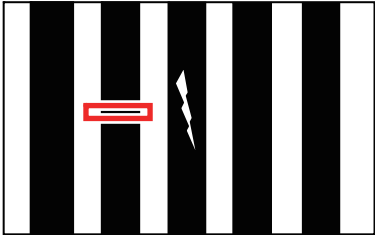

Defect



Precautions for Correct Use

- This processing item is specialized for monochrome images. When using a color camera, insert the *Color Gray Filter* processing item before this one. If a color image is input, this item becomes NG (incompatible image).
- Processing is different for color images and monochrome images. When the camera type used in the previous setup was changed to color or monochrome type, perform the settings again.

3-8-1 Filter Setting (Stripes Removal Filter II)

This item sets the filter.

- 1 In the Item tab area, click **Filter**, and then click **Filter setting**.
- 2 In the *Display* area, click **Change display** to switch between camera image types. The display on the *Image display* area will be switched.

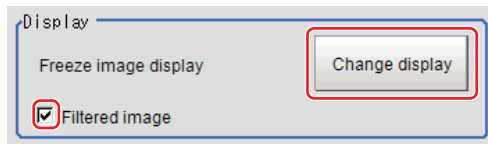

Setting item	Setting value [Factory default]	Description
Display	<ul style="list-style-type: none"> • Through image • [Freeze image] 	<ul style="list-style-type: none"> • Through image: The latest image is always loaded from the camera and displayed. • Freeze image: The image loaded in the immediately preceding measurement is displayed.
Filtered image	<ul style="list-style-type: none"> • [Checked] • Unchecked 	Unchecks this to display the original image.

- 3 Set the target image.

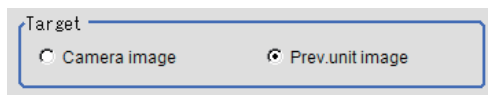

Setting item	Setting value [Factory default]	Description
Target	<ul style="list-style-type: none"> • Camera image • [Prev. unit image] 	<ul style="list-style-type: none"> • Camera image: The camera input image that has not been subject to filtering is subject to correction as is. • Prev. unit image: Images to which processing was applied in a processing unit prior to the Brightness Correct Filter being set are the targets.

- 4 Set the correction method.

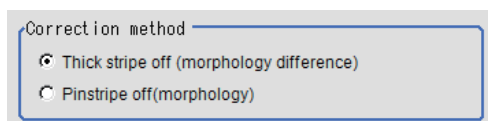

Setting item	Setting value [Factory default]	Description
Method	<ul style="list-style-type: none"> • [Thick stripe off] • Pinstripe off 	<ul style="list-style-type: none"> • Thick stripe off Sets the filter size based on the size of the expected defect and removes the striped patterns. • Pinstripe off Sets the filter size based on the width of the stripes and removes the striped patterns.



Precautions for Correct Use

When changing this setting, the filter and detail settings will be reset to the factory default.

5 Set the filter.

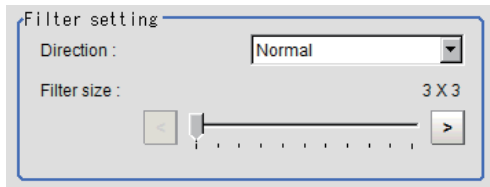

Setting item	Setting value [Factory default]	Description
Direction	<ul style="list-style-type: none"> • [Normal] • Vertical • Horizontal • Upper right • Lower right 	Specifies the filter direction.
Filter size	3 to 63 [3]	Specifies this value based on the size of the defect to extract or the size of the stripes. Only an odd value is available. Pinstripe off: Select a filter size larger than the width of the striped pattern. Thick stripe off: Select a filter size larger than the defect to detect.

6 Set the details.

Correction method: For *Thick stripe off*

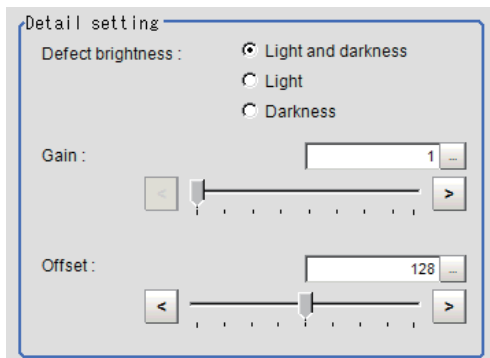

Setting item	Setting value [Factory default]	Description
Defect brightness	<ul style="list-style-type: none"> [Light and darkness] Light Darkness 	Sets the brightness of defects to extract from the background. When detecting both white and black defects, select <i>Light and darkness</i> .
Gain	1 to 63 [1]	Adjusts the contrast of an image after the pattern suppression. Increasing the value emphasizes the concentration differences in images.
Offset	0 to 255 [128]	Adjusts the brightness of an image after the pattern suppression. Increasing the value makes images brighter.

Correction method: For *Pinstripe off*

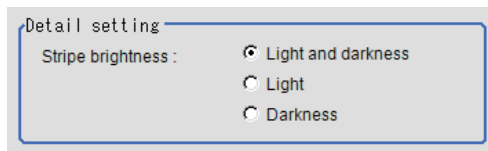

Setting item	Setting value [Factory default]	Description
Stripe brightness	<ul style="list-style-type: none"> [Light and darkness] Light Darkness 	Selects the color of the stripes to be deleted.

3-8-2 Region Settings (Stripes Removal Filter II)

It is possible to target the entire screen, but restricting the range can shorten the processing time.

- 1** In the Item tab area, click **Region setting**.
- 2** Click **Edit**.
The *Figure setting* area is displayed.
- 3** Use the Drawing tools to specify the measurement region.
- 4** Click **OK** in the *Figure setting* area.
 - **OK**: Changes the settings and returns to the previous menu.
 - **Cancel**: Changes are discarded and returns to the previous menu.
 - **Apply**: Updates the settings without leaving the current window.

3-8-3 Key Points for Test Measurement and Adjustment (Stripes Removal Filter II)

The image specified in the Sub-image number in the image display setting is displayed in the *Image Display* area.

Sub-image number	Description of image to be displayed
0	Post-conversion image

3-8-4 External Reference Tables (Stripes Removal Filter II)

No.	Data name	Data ident	Set/Get	Data range
0	Judge	judge	Get only	0: No judgment (unmeasured), 1: Judgment result OK, -1: Judgment result NG, -10: Error (image format mismatch), -11: Error (unregistered model), -12: Error (insufficient memory), -20: Error (other errors)
120	Method	correctionMethod	Set/Get	0: Thick stripe cut 1: Thin stripe cut
121	Filter direction	direction	Set/Get	0: H&V, 1: Horizontal, 2: Vertical, 3: Diagonal (upper right), 4: Diagonal (lower right)
122	Filter size	filterSize	Set/Get	3 to 63
123	Brightness	defectBrightness	Set/Get	0:Light and Dark1:Light2:Dark
124	Gain	gain	Set/Get	1 to 63
125	Offset	offset	Set/Get	0 to 255
200	Conversion former image	srcImageNo	Set/Get	0 to 9
201	Destination image No.	destImageNo	Set/Get	0 to 9
202	Target image	targetImage	Set/Get	0: Camera image 1: Prev. unit image
203	display image	filteredImage	Set/Get	0: Display Input image 1: Display filtered image
90,000	figure0 Count	figArea0_count	Set/Get	1
90,001	figure0 Type	figArea0_fig0_type	Set/Get	8: Rectangle
90,002	figure0 mode	figArea0_fig0_mode	Set/Get	0: OR
90,014	figure0 Rectangle Upper left position X	figArea0_fig0_box_X0	Set/Get	-99,999 to 99,999
90,015	figure0 Rectangle Upper left position Y	figArea0_fig0_box_Y0	Set/Get	-99,999 to 99,999
90,016	figure0 Rectangle Lower right position X	figArea0_fig0_box_X1	Set/Get	-99,999 to 99,999
90,017	figure0 Rectangle Lower right position Y	figArea0_fig0_box_Y1	Set/Get	-99,999 to 99,999
90,099	figure0 Update	figArea0_update	Set only	1: Update

3-9 Polar Transformation

Wide circle and fan shape images are transformed in polar coordinates and converted into orthogonal coordinate images. The converted image is a measurement object for processing units in later stages.

Used in the Following Case

This item judges characters printed around the circumference of caps and the like:

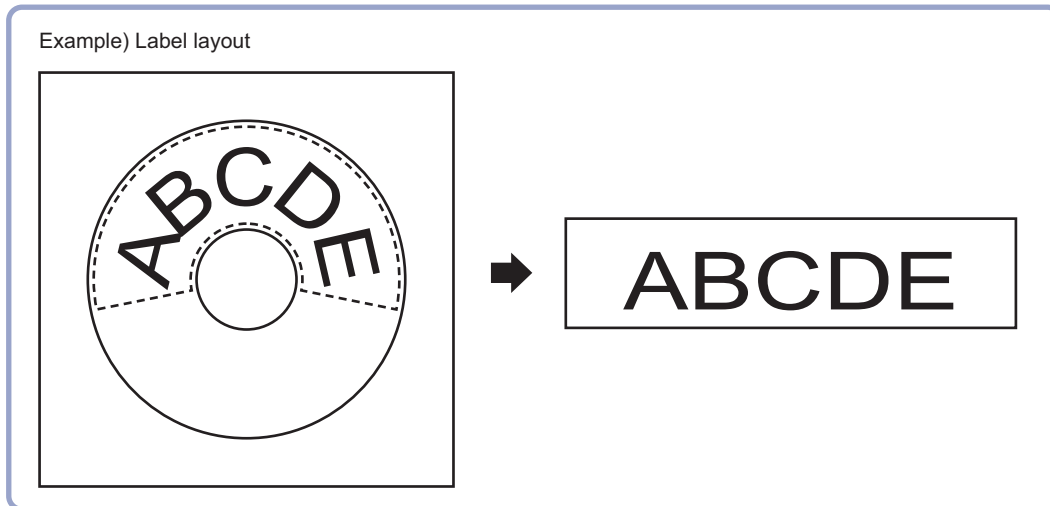

Precautions for Correct Use

- When using polar transformation and a position list, display with *Polar Transformation*. If the image is displayed with *Camera Image Input* or the like before the *Polar Transformation*, the graphic is not displayed correctly.
- *Polar Transformation* is always performed in a clockwise direction regardless of *Region settings*.
- Processing is different for color images and monochrome images. When the camera type used in the previous setup was changed to color or monochrome type, perform the settings again.
- In the measurement flow, if the processing unit that generates the calibration data is set after the processing unit that corrects the image, the output coordinates that can be acquired by the processing unit after the processing unit that generates the calibration data are only the coordinates after image correction.

3-9-1 Region Settings (Polar Transformation)

Set a region enclosing the character string that is lined up along a circle. Polar Transformation's Region setting includes Circumference and Wide arc selections.

- 1** Use the Drawing tools to specify the measurement region.
- 2** Enclose the characters on the image.



3 Click **ON**.

- **OK**: Changes the settings and returns to the previous menu.
- **Cancel**: Changes are discarded and returns to the previous menu.
- **Apply**: Updates the settings without leaving edit window.

The measurement region is registered and displayed in the *Image display* area.

4 When *Circumference* is selected, set the items in the *Circle setting* area.
When *Wide arc* is selected, detailed settings are not required.

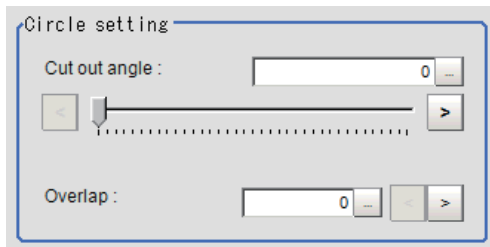

Setting item	Setting value [Factory default]	Description
Cut out angle	0 to 359 [0]	Sets the angle for starting extraction when the figure is a wide circle.
Overlap	0 to 180 [0]	Sets the angle for overlap when the figure is a wide circle. The overlap angle indicates the end angle of the measurement range. This is set to measure extra overlapping from the start angle. Basically, set this larger than the <i>extraction angle</i> .

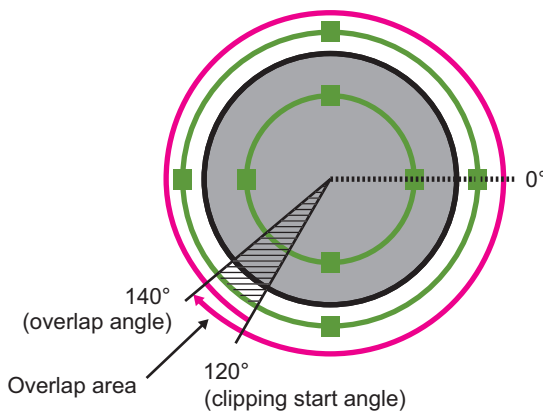

5 Place a check at *Disp transferred image*.

The polar transformed image is displayed in the image window.

The vertical and horizontal image sizes (in pixels) are displayed with overlapped.

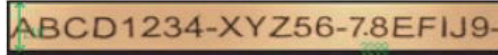
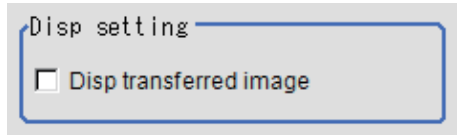

3-9-2 Key Points for Test Measurement and Adjustment (Polar Transformation)

The image specified in the Sub-image number in the image display setting is displayed in the *Image Display* area.

Sub-image number	Description of image to be displayed
0	Post-conversion image
1	Measurement image

3-9-3 Measurement Results for Which Output Is Possible (Polar Transformation)

The following values can be output using processing items related to result output. It is also possible to reference measurement values from calculation expressions and other processing units.

Measurement items	Character string	Description
Judge	JG	Judgment results 0: No judgment (unmeasured) 1: Judgment result OK -1: Judgment result NG -10: Error (image format mismatch) -11: Error (unregistered model) -12: Error (insufficient memory) -20: Error (other errors)

3-9-4 External Reference Tables (Polar Transformation)

No.	Data name	Data ident	Set/Get	Data range
0	Judge	judge	Get only	0: No judgment (unmeasured), 1: Judgment result OK, -1: Judgment result NG, -10: Error (image format mismatch), -11: Error (unregistered model), -12: Error (insufficient memory), -20: Error (other errors)
120	Cut out angle	cutOutAngle	Set/Get	0 to 359
122	Overlap	overlapEnd	Set/Get	0 to 360
123	Disp transferred image	dispTransImage	Set/Get	0: Image prior to transfer 1: Image after transfer

No.	Data name	Data ident	Set/Get	Data range
6,002	Format	cameraColor	Set/Get	1: Monochrome camera 2: Color camera
90,000	figure0 Count	figArea0_count	Set/Get	0 to 1
90,001	figure0 Type	figArea0_fig0_type	Set/Get	64: Circumference 256: Wide arc
90,002	figure0 mode	figArea0_fig0_mode	Set/Get	0: OR
90,025	figure0 Circumference Center Position X	figArea0_fig0_circleW_X	Set/Get	-99,999 to 99,999
90,026	figure0 Circumference Center Position Y	figArea0_fig0_circleW_Y	Set/Get	-99,999 to 99,999
90,027	figure0 Circumference Radius	figArea0_fig0_circleW_R	Set/Get	0 to 99,999
90,028	figure0 Circumference Width	figArea0_fig0_circleW_W	Set/Get	0 to 99,999
90,034	figure0 Wide arc Center Position X	figArea0_fig0_arcW_X	Set/Get	-99,999 to 99,999
90,035	figure0 Wide arc Center Position Y	figArea0_fig0_arcW_Y	Set/Get	-99,999 to 99,999
90,036	figure0 Wide arc Radius	figArea0_fig0_arcW_R	Set/Get	0 to 99,999
90,037	figure0 Wide arc Start angle	figArea0_fig0_arcW_SA	Set/Get	-180 to 180
90,038	figure0 Wide arc End angle	figArea0_fig0_arcW_EA	Set/Get	-180 to 180
90,039	figure0 Wide arc Width	figArea0_fig0_arcW_W	Set/Get	0 to 99,999
90,099	figure0 Update	figArea0_update	Set only	1: Update

3-10 Trapezoidal Correction

This item converts the input image to orthogonal coordinates when performing a measurement in a state of the measurement object tilted or the camera tilted.

Used in the Following Case

When processing a trapezoidal image shot with slant angle to make an inspection easy:

Perform processing so that a trapezoid-shaped image in which the object is displayed diagonally can be more easily inspected.

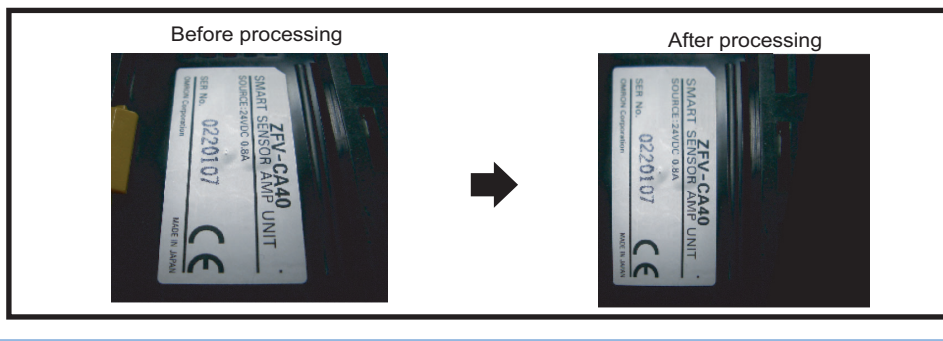

Precautions for Correct Use

- Processing is different for color images and monochrome images. When the camera type used in the previous setup was changed to color or monochrome type, perform the settings again.
- In the measurement flow, if the processing unit that generates the calibration data is set after the processing unit that corrects the image, the output coordinates that can be acquired by the processing unit after the processing unit that generates the calibration data are only the coordinates after image correction.

3-10-1 Conversion Method (Trapezoidal Correction)

This sets the input image conversion method.

- 1 In the Item Tab area, click **Conv. method**.
When making a new setting, do not need to click **Conv. method**.
- 2 Set the parameters as necessary.

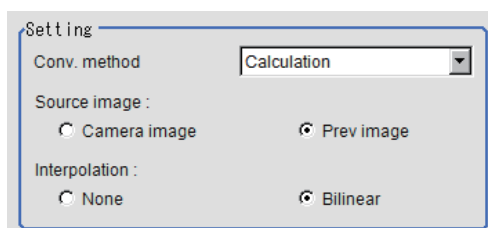

Setting item	Setting value [Factory default]	Description
Conv. method	<ul style="list-style-type: none"> 4-unit reference [Calculation] 	<p>Selects the expression used for image conversion.</p> <p>4-unit reference: The parameters are set by referencing the reference coordinates and measurement coordinates for the immediately preceding 4-unit. Check that the unit arrangement is according to the upper left coordinate, lower left coordinate, lower right coordinate and upper right coordinate.</p> <p>Selects <i>Calculation</i> when modifying calculations for the reference and measurement positions set by 4-unit reference.</p>
Source image	<ul style="list-style-type: none"> Camera image [Prev. unit image] 	Selects the image to compensate.
Interpolation	<ul style="list-style-type: none"> [None] Bilinear 	<p>Selects the interpolation between pixels for image conversion.</p> <p>Set <i>None</i> when reducing the conversion time rather than increasing correction accuracy.</p>

3 Set the reference positions.

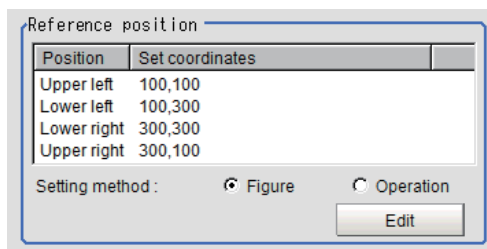

Setting item	Setting value [Factory default]	Description
Setting method	<ul style="list-style-type: none"> [Figure] Calculation 	<p>Select the method for setting the reference position.</p> <p>When <i>Figure</i> (fixed values) is selected, specify the vertex positions on the image.</p> <p>When the setting is changed to <i>Figure</i> after setting with an expression, the expression result is reflected as the value of <i>Figure</i>.</p>

③ When *Operation* is selected:

- 1) Click **Edit**.
- 2) Click ... to set the expression.
For details, refer to 4-3-3 *Layout of Setting Expression Window (Calculation)* on page 4-12.

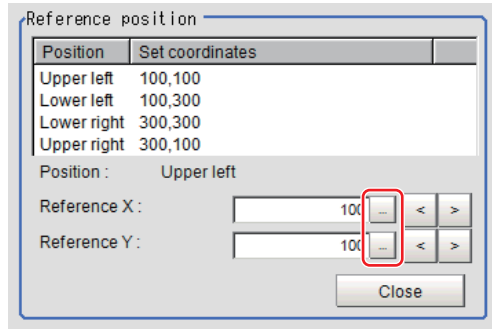

4 Set the measurement positions.

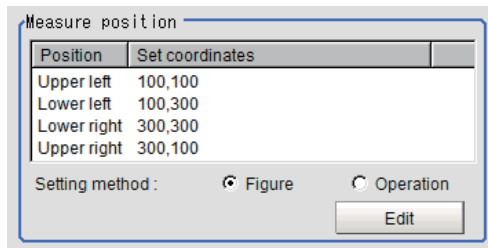

Setting item	Setting value [Factory default]	Description
Setting method	<ul style="list-style-type: none"> [Figure] Calculation 	Select the method for setting the reference position. When <i>Figure</i> (fixed values) is selected, specify the vertex positions on the image. When the setting is changed to <i>Figure</i> after setting with an expression, the expression result is reflected as the value of <i>Figure</i> .

5 Set the display setting as necessary.

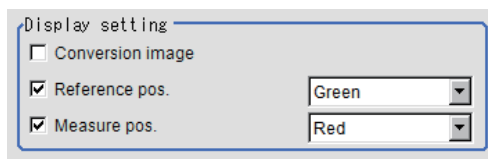

Example of Setting

The following is the setting examples for the reference positions and measurement positions.

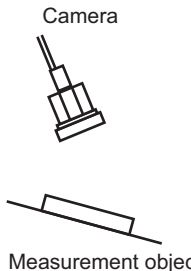
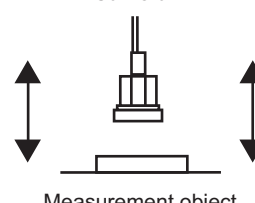
Setting item	Pattern 1	Pattern 2
	Camera: Fixed tilt workpiece: No chatter 	Camera: Fixed vertical Workpiece: Chatter 
Reference position	Figure	Figure

Setting item	Pattern 1	Pattern 2
Measurement position	Figure	Calculation

- Pattern 1:
The camera is installed with slanted and there is no chatter in the workpiece.
For details, refer to *Setting Example for When There Is No Chatter in the Work* on page 3-52.
- Pattern 2:
The camera is installed vertically and there is chatter in the workpiece.
For details, refer to *Setting Example for When There Is Chatter in the Work* on page 3-53.

Setting Example for When There Is No Chatter in the Work

Even when there is a mechanical structure and the camera cannot be installed from the front, 4-point position information enables distorted images to be compensated.

When specifying four points for distortion compensation and setting their correct positions as the reference positions, parameters for distortion compensation are automatically set. Distortions are automatically compensated based on the parameters whenever measurements are performed.

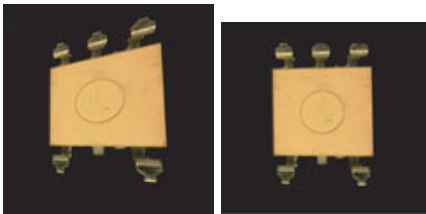

Crooked image

After revision

- 1 Select *Figure* and then click **Edit**.

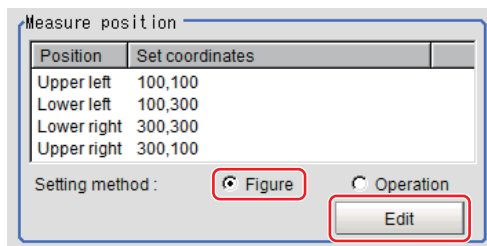

- 2 Specify four points on the image, whose information is used to compensate distortion.



- 3 Select *Figure* for the reference positions and then click **Edit**.

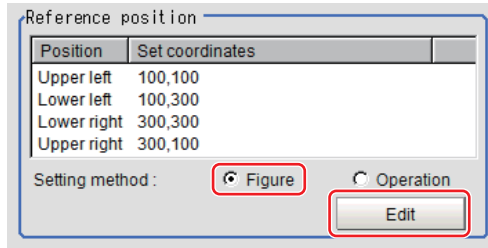

- 4** Specify the information of the four points in the correct positions on the image, which information is used to compensate distortion. When concrete coordinate positions are known or accurate positions are required by measurement, it is also possible to substitute measurement values of other processing units by setting *Operation*.



- 5** Place a check at *Conversion image* in the "Display settings" and check the image in which the distortion has been compensated.

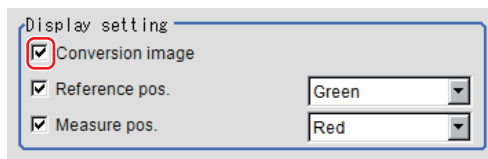

Setting Example for When There Is Chatter in the Work

Even when there is chatter in workpieces during transportation and errors are generated in the distance between the workpieces and the camera, 4-point position information can be used to compensate distortion in the image.

Set the correct positions for the four points as the reference position and set them to other units to get the position information of four points whenever a measurement is done. Compensate distorted images by fitting the position information to the reference position at measurement. With this setting, position deviation in three-dimensional directions can be compensated.

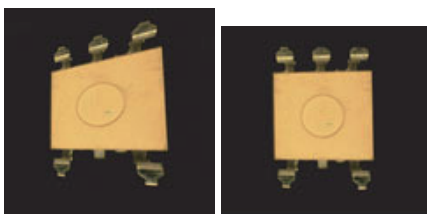

Crooked image

After revision

- 1** Select *Operation* for the measurement position and click **Edit**.

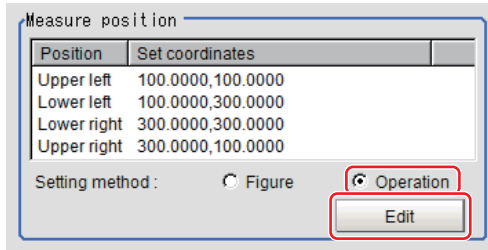

- 2** Specify which four points information to use for distortion compensation with expression. Set the processing unit for getting the positions prior to this processing unit.

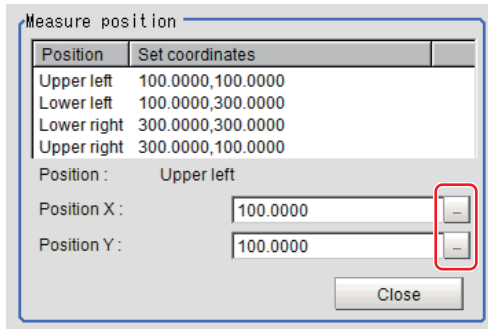

- 3** Select *Figure* for the reference position and then click **Edit**.

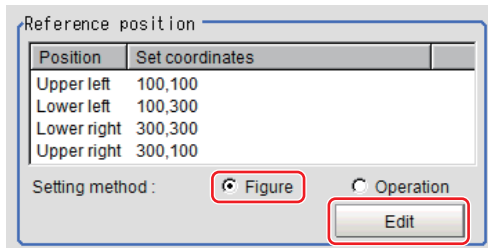

- 4** Specify the information of the four points in the correct positions on the image, which information is used to compensate distortion. When concrete coordinate positions are known or accurate positions are required by measurement, it is also possible to substitute measurement values of other processing units by setting *Operation*.



- 5** Place a check at *Conversion image* in the "Display settings" and check the image in which the distortion has been compensated.

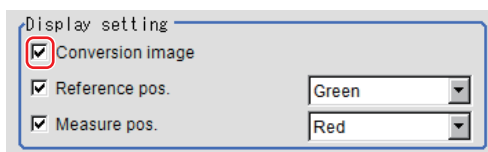

3-10-2 Region Settings (Trapezoidal Correction)

Specify as a rectangle the range for compensating in the image. It is possible to target the entire screen, but restricting the range can shorten the processing time.

- 1** In the Item tab area, click **Region setting**.
- 2** Click **Edit**.
The *Figure setting* area is displayed.
- 3** Use the Drawing tools to specify the measurement region.
- 4** Click **OK** in the *Figure setting* area.
 - **OK**: Changes the settings and returns to the previous menu.
 - **Cancel**: Changes are discarded and returns to the previous menu.
 - **Apply**: Updates the settings without leaving the current window.

3-10-3 Key Points for Test Measurement and Adjustment (Trapezoidal Correction)

The following content is displayed in the *Detail result* area as text.

Displayed item	Description
Judge	Judgment results 0: No judgment (unmeasured) 1: Judgment result OK -1: Judgment result NG -10: Error (image format mismatch) -11: Error (unregistered model) -12: Error (insufficient memory) -20: Error (other errors)

The image specified in the Sub-image number in the image display setting is displayed in the *Image Display* area.

Sub-image number	Description of image to be displayed
0	Post-conversion image

3-10-4 Measurement Results for Which Output Is Possible (Trapezoidal Correction)

The following values can be output using processing items related to result output. It is also possible to reference measurement values from calculation expressions and other processing units.

Measurement items	Character string	Description
Judge	JG	Judgment results 0: No judgment (unmeasured) 1: Judgment result OK -1: Judgment result NG -10: Error (image format mismatch) -11: Error (unregistered model) -12: Error (insufficient memory) -20: Error (other errors)

3-10-5 External Reference Tables (Trapezoidal Correction)

No.	Data name	Data ident	Set/Get	Data range
0	Judge	judge	Get only	0: No judgment (unmeasured), 1: Judgment result OK, -1: Judgment result NG, -10: Error (image format mismatch), -11: Error (unregistered model), -12: Error (insufficient memory), -20: Error (other errors)
120	Compensation mode	compensation	Set/Get	0 to 1
121	Setting method	setupMode	Set/Get	0 to 1
122	Source image	targetImage	Set/Get	0 to 1
123	Reference position setting method	refPosSetMethod	Set/Get	0 to 1
124	Measurement position setting method	measPosSetMethod	Set/Get	0 to 1
125	Reference position display	referenceDisp	Set/Get	0 to 1
126	Reference position display color	referenceDispColor	Set/Get	0: Black, 1: White, 2: Red, 3: Green, 4: Blue
127	Display coordinates	measureDisp	Set/Get	0 to 1
128	Color of the display coordinates	measureDispColor	Set/Get	0: Black, 1: White, 2: Red, 3: Green, 4: Blue
129	Conversion image	convertImageDisp	Set/Get	0 to 1
200	Set data reference Upper left position X	setDataRefX0	Set/Get	Exp. character string
201	Set data reference Lower left position X	setDataRefX1	Set/Get	Exp. character string
202	Set data reference Lower right position X	setDataRefX2	Set/Get	Exp. character string
203	Set data reference Upper right position X	setDataRefX3	Set/Get	Exp. character string
300	Set data reference Upper left position Y	setDataRefY0	Set/Get	Exp. character string
301	Set data reference Lower left position Y	setDataRefY1	Set/Get	Exp. character string

No.	Data name	Data ident	Set/Get	Data range
302	Set data reference Lower right position Y	setDataRefY2	Set/Get	Exp. character string
303	Set data reference Upper right position Y	setDataRefY3	Set/Get	Exp. character string
400	Set data measurement Upper left position X	setDataMeasX0	Set/Get	Exp. character string
401	Set data measurement Lower left position X	setDataMeasX1	Set/Get	Exp. character string
402	Set data measurement Lower right position X	setDataMeasX2	Set/Get	Exp. character string
403	Set data measurement Upper right position X	setDataMeasX3	Set/Get	Exp. character string
500	Set data measurement Upper left position Y	setDataMeasY0	Set/Get	Exp. character string
501	Set data measurement Lower left position Y	setDataMeasY1	Set/Get	Exp. character string
502	Set data measurement Lower right position Y	setDataMeasY2	Set/Get	Exp. character string
503	Set data measurement Upper right position Y	setDataMeasY3	Set/Get	Exp. character string
90,000	figure0 Count	figArea0_count	Set/Get	1
90,001	figure0 Type	figArea0_fig0_type	Set/Get	8: Rectangle
90,002	figure0 mode	figArea0_fig0_mode	Set/Get	0: OR
90,014	figure0 Rectangle Upper left position X	figArea0_fig0_box_X0	Set/Get	-99,999 to 99,999
90,015	figure0 Rectangle Upper left position Y	figArea0_fig0_box_Y0	Set/Get	-99,999 to 99,999
90,016	figure0 Rectangle Lower right position X	figArea0_fig0_box_X1	Set/Get	-99,999 to 99,999
90,017	figure0 Rectangle Lower right position Y	figArea0_fig0_box_Y1	Set/Get	-99,999 to 99,999
90,099	figure0 Update	figArea0_update	Set only	1: Update

3-11 Machine Simulator

This item is not available in the FHV series.

You can simulate the movement of an alignment mark and verify the operation of alignment-related processing items without an actual stage or robot. Actual coordinate system conditions (origin position, magnification, axis angle) can be set as desired in this processing item group. For the origin position, set the rotating center of the stage.

Used in the Following Case

- Check alignment operations before connecting the stage:
- Create scene data before connecting the stage:

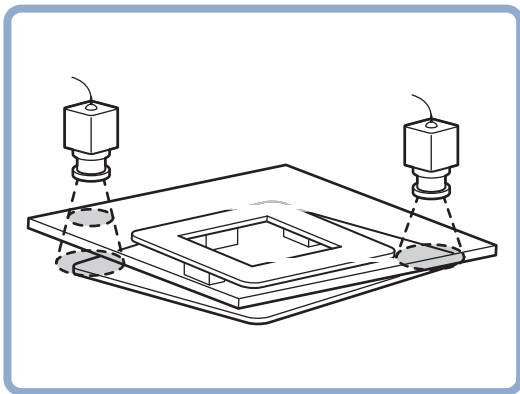

3-11-1 Settings Flow (Machine Simulator)

Set up the machine simulator with the following steps.

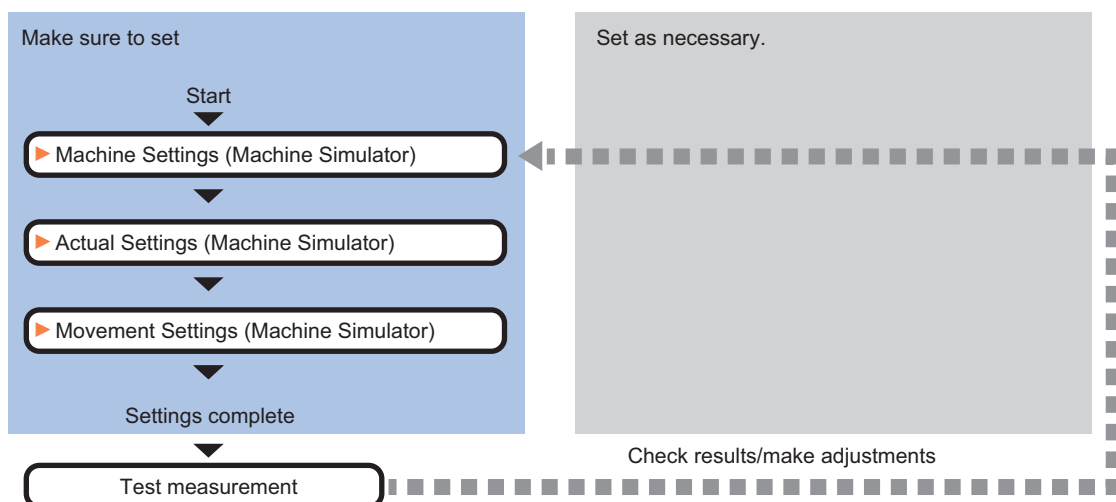

List of Machine Simulator Items

Item	Description
Machine setting	Selects a processing item such as <i>Stage Data</i> or <i>Robot Data</i> under which external device information needed for calculation travel distance of the actuator is held. <i>3-11-2 Machine Setting (Machine Simulator)</i> on page 3-59
Actual setting	Sets the conditions for the real coordinate system such as origin position, magnification, and the axis angle. Set the coordinate system of the stage or robot used as the conditions. <i>3-11-3 Actual Setting (Machine Simulator)</i> on page 3-60
Movement setting	Sets the movement amount of each axis needed to move the image. When simulating a movement from other than the origin return position, set the current axis position too. <i>3-11-4 Movement Setting (Machine Simulator)</i> on page 3-61

3-11-2 Machine Setting (Machine Simulator)

Select a processing item such as *Stage Data* or *Robot Data* under which external device information needed for calculation of axis movement amount of the actuator is held.

- 1 In the Item tab area, click **Machine setting**.
- 2 Select a processing unit holding the external device information.
The information of the selected processing unit is displayed in the *Reference data display* area. Displayed contents vary depending on the selected type of robot or stage.

Machine setting data

Reference scene No. : Present scene

Reference unit No. : 2 Stage data

Reference data

Stage type : XY stage

Setting item	Setting value [Factory default]	Description
Reference scene No.	[Present scene] Scene 0 to 127	Selects the scene number including a processing item such as <i>Stage Data</i> or <i>Robot Data</i> under which the external device information needed for calculating the axis movement amount of the actuator is held.
Reference No.	-	From among the referenced scene numbers, selects a processing item such as <i>Stage Data</i> or <i>Robot Data</i> under which the external device information needed for calculating the axis movement amount of the actuator is held.
Reference data	-	Displays the settings of <i>Stage Data</i> or <i>Robot Data</i> processing item.



Additional Information

When the number of scenes is increased with the scene group conversion tool, the upper limit value that is selectable in *Reference scene No.* is changed.

3-11-3 Actual Setting (Machine Simulator)

Set the conditions of the actual coordinate system such as origin position, magnification, and axis angle as camera coordinate system. Set the coordinate system of stage or robot used as the conditions. The camera coordinate system is the one for images captured with a camera and the unit is in pixels. Its origin is upper left of the camera. The X-axis is from left to right horizontal direction and its value increases from left to right. The Y-axis is from top to bottom direction and its value increases from top to bottom.

- 1 In the Item Tab area, click **Actual setting**.
- 2 Set the conditions for the actual coordinate system in the *Actual setting* area.
When changing the settings, the compensation result is displayed in the *Image display* area.

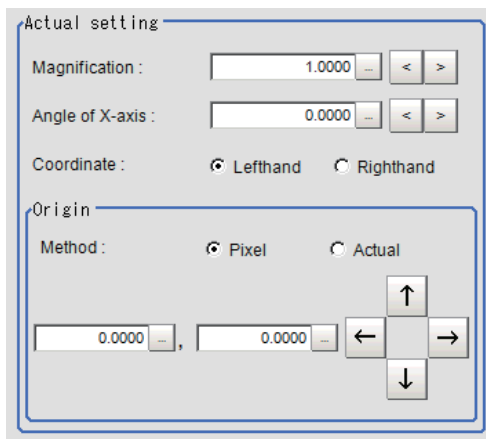

Setting item	Setting value [Factory default]	Description
Magnification	0.0001 to 9.9999 [1.0000]	Specifies the ratio of one pixel to the actual dimensions. When one pixel in the camera coordinate system corresponds to 1 mm in actual dimension, set 1. When it corresponds to 0.1 mm in actual dimension, set 0.1.
X Angle of X-axis	-180.0000 to 180.0000 [0.0000]	When the movement amount of each axis is 0, set X-axis angle in the actual coordinate system of the camera coordinate system.
Coordinate	<ul style="list-style-type: none"> • [Lefthand] • Righthand 	Selects the coordinate system to use. <ul style="list-style-type: none"> • Lefthand The clockwise is forward when setting the coordinates. • Righthand The counter-clockwise is forward when setting the coordinates.

Setting item	Setting value [Factory default]	Description
Setting method	<ul style="list-style-type: none"> [pixel] Actual 	Sets the specification method for the rotation center position (origin) of the stage returned to the origin. <ul style="list-style-type: none"> Pixel: Specifies the pixel value for the origin in the camera coordinate system. Actual: Specifies the origin with the value on the actual coordinate system and not the pixel value on the camera image.
X Y	-99,999.9999 to 99,999.9999 [0.0000]	Sets the coordinates with the method specified in the <i>Method</i> .

3-11-4 Movement Setting (Machine Simulator)

Set the movement amount for each axis needed to move images. When simulating a movement from a position other than the origin return position, set the current axis position too.

- 1 In the Item Tab area, click **Movement setting**.
- 2 In the *Source image* area, select the target image to move.

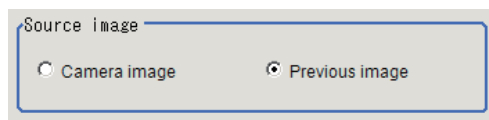

Setting item	Setting value [Factory default]	Description
Source image	<ul style="list-style-type: none"> Camera image [Prev. unit image] 	<ul style="list-style-type: none"> Camera image: The target image to move is the unfiltered camera input image. Prev. image: The target image to move is an image filtered by a processing unit prior to Machine Simulator currently in process.

- 3 Set the current position of each axis in the *Current setting* area. The setting items vary depending on the type of stage or robot.

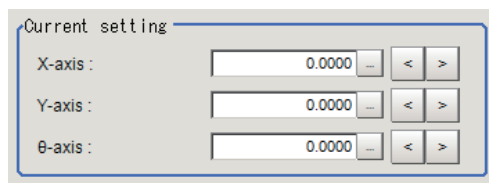

Setting item	Setting value [Factory default]	Description
X	-99,999.9999 to 99,999.9999 [0.0000]	Sets the current position of each axis of stage or robot.
Y	-99,999.9999 to 99,999.9999 [0.0000]	
θ	-180.0000 to 180.0000 [0.0000]	

- 4** In the *Axis movement* area, set the movement amount of each axis.
The setting items vary depending on the type of stage or robot.

Setting item	Setting value [Factory default]	Description
X axis movement	-99,999.9999 to 99,999.9999 [0.0000]	Sets the movement amount of each axis stage or robot.
Y axis movement	-99,999.9999 to 99,999.9999 [0.0000]	
θ axis movement	-360.0000 to 360.0000 [0.0000]	

3-11-5 Key Points for Test Measurement and Adjustment (Machine Simulator)

The image specified in the Sub-image number in the image display setting is displayed in the *Image Display* area.

Sub-image number	Description of image to be displayed
0, 2 to 31	Measurement image (Same when a list of positions is displayed)
1	Input image

Key Points for Adjustment (Machine Simulator)

Adjust the setting parameters referring to the following points.

● The image is not compensated correctly

Parameter to be adjusted	Remedy
Actual setting	When the corrected image is completely different, the conditions for the actual coordinate system (origin position, magnification, axis angle) may not have been set correctly. Check for input errors. In factory default, the real coordination system is the same as the camera's one.
Movement setting	When the corrected image is slightly different, The current axis position may not have been set correctly. Set this condition when simulating a movement from other than the origin return position. The current axis position is a parameter required for accurate calculation of the travel distance of the actuator.

● Others

Parameter to be adjusted	Remedy
Machine setting	<p>When the reference unit number is <None> and cannot be selected, check if the reference scene number is selected correctly.</p> <p>Check if stage data processing items or robot data processing items are registered in the selected reference scene.</p> <p>The reference unit number does not change during flow editing, which is the specifications.</p> <p>While a scene other than the current scene is referenced, the reference unit number does not change according to the editing of the flow. Change the flow so that the current scene will be referenced, or set the reference unit number again.</p>

3-11-6 Measurement Results for Which Output Is Possible (Machine Simulator)

The following values can be output using processing items related to result output. It is also possible to reference measurement values from calculation expressions and other processing units.

Measurement items	Character string	Description
Judge	JG	Judgment results 0: No judgment (unmeasured) 1: Judgment result OK -1: Judgment result NG -10: Error (image format mismatch) -11: Error (unregistered model) -12: Error (insufficient memory) -20: Error (other errors)

3-11-7 External Reference Tables (Machine Simulator)

No.	Data name	Data ident	Set/Get	Data range
0	Judge	judge	Get only	0: No judgment (unmeasured), 1: Judgment result OK, -1: Judgment result NG, -10: Error (image format mismatch), -11: Error (unregistered model), -12: Error (insufficient memory), -20: Error (other errors)
120	Reference scene No.	sceneNo	Set/Get	-1: Current scene referred 0 to 9,999: Pointed scene referred
121	Reference unit No.	unitNo	Set/Get	-1: No reference 0 to 9,999: Pointed unit referred
122	Magnification	scale	Set/Get	0.0001 to 9.9999
123	Angle of X-axis	angle	Set/Get	-180 to 180
124	Coordinate	coordinate	Set/Get	0: Lefthand, 1: Righthand
125	Origin X(pix)	centerX	Set/Get	-99,999.9999 to 99,999.9999
126	Origin Y(pix)	centerY	Set/Get	-99,999.9999 to 99,999.9999
127	Source image	targetImage	Set/Get	0: Camera image 1: Previous image
128	X-axis movement	moveX	Set/Get	-99,999.9999 to 99,999.9999
129	Y-axis movement	moveY	Set/Get	-99,999.9999 to 99,999.9999
130	θ -axis movement	moveTheta	Set/Get	-360 to 360
131	θ -axis (linear drive)	moveLinearTheta	Set/Get	-99,999.9999 to 99,999.9999
132	U-axis movement	moveU	Set/Get	-99,999.9999 to 99,999.9999
133	V-axis movement	moveV	Set/Get	-99,999.9999 to 99,999.9999
134	W-axis movement	moveW	Set/Get	-99,999.9999 to 99,999.9999
135	R-axis movement	moveR	Set/Get	-99,999.9999 to 99,999.9999
136	Current X-axis movement	currentPosX	Set/Get	-99,999.9999 to 99,999.9999
137	Current Y-axis movement	currentPosY	Set/Get	-99,999.9999 to 99,999.9999
138	Current θ -axis movement	currentPosTheta	Set/Get	-180 to 180
139	Current θ -axis (linear drive)	currentPosLinear-Theta	Set/Get	-99,999.9999 to 99,999.9999
140	Current U-axis movement	currentPosU	Set/Get	-99,999.9999 to 99,999.9999
141	Current V-axis movement	currentPosV	Set/Get	-99,999.9999 to 99,999.9999
142	Current W-axis movement	currentPosW	Set/Get	-99,999.9999 to 99,999.9999
143	Current R-axis movement	currentPosR	Set/Get	-99,999.9999 to 99,999.9999
144	Origin X(Actual)	originX	Set/Get	-99,999.9999 to 99,999.9999
145	Origin Y(Actual)	originY	Set/Get	-99,999.9999 to 99,999.9999

No.	Data name	Data ident	Set/Get	Data range
146	Setting method of origin	originSetting	Set/Get	0: Pixel 1: Actual

3-12 Image Subtraction

This item compares a measurement image with the model registered image and converts only pixels with differences to an image extracted.

Used in the Following Case

When extracting only target parts to inspect from the image

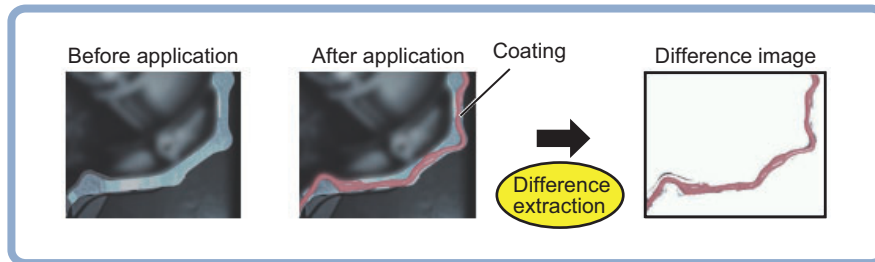

Precautions for Correct Use

- Processing is different for color images and monochrome images. When the camera type used in the previous setup was changed to color or monochrome type, perform the settings again.
- Even if the image before applying this processing is a monochrome image, this will convert it to a color image after applied.

3-12-1 Settings Flow (Image Subtraction)

To set Image Subtraction, follow the steps below.

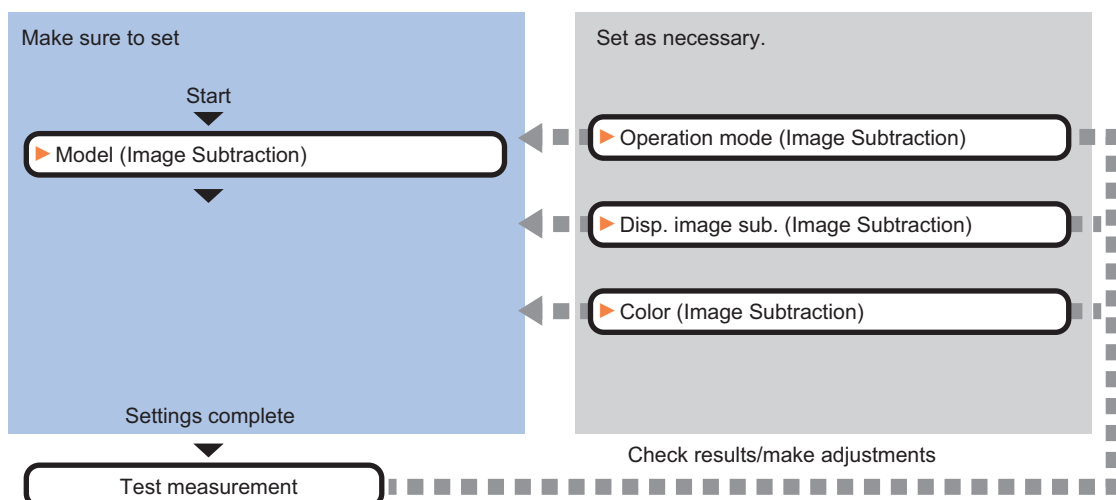

List of Image Subtraction Items

Item	Description
Operation mode	Sets the operation mode during measurement. 3-12-2 <i>Operation Mode (Image Subtraction)</i> on page 3-67

Item	Description
Model	Registers model images. <i>3-12-3 Model (Image Subtraction)</i> on page 3-68
Disp. image sub.	Sets the method for extracting the difference images. <i>3-12-4 Disp. Image Sub. (Image Subtraction)</i> on page 3-69
Color setting	Sets the background color of the difference images. <i>3-12-5 Color (Image Subtraction)</i> on page 3-70

3-12-2 Operation Mode (Image Subtraction)

Set how to switch the model registration and difference extraction at measurement.

- 1** In the Item Tab area, click **Operation mode**.
- 2** In the *Operation mode* area, set each item.

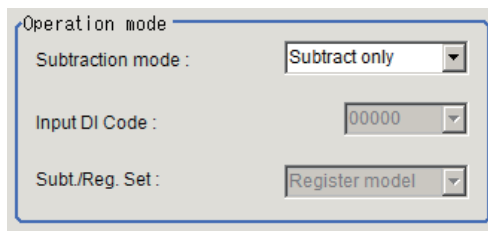

Setting item	Setting value [Factory default]	Description
Subtraction mode	<ul style="list-style-type: none"> • [Subtract only] • DI Register • Subt./Reg. 	<ul style="list-style-type: none"> • Subtract only Always use the initially registered model image to perform the difference extraction processing. The model registration is performed in the setting mode. The difference extraction processing is always performed to measurement target images captured in the operation mode. • DI Register The DI input (4 to 0) is checked during measurement processing. The model registration is performed only to signal input of patter set in <i>Input DI Code</i>. In other case, the difference extraction processing is performed. A model image is captured and registered during operation, after that, the difference extraction processing is performed. • Sub./Reg. The model registration and difference extraction are switched whenever performing a measurement. Select this when performing re-measurement with logging images. Since the model image and measurement image can be loaded alternately, the processing of the model registration and measurement can be done offline.
Input DI Code (4 to 0)	00000 to 11111(binary numbers) [00000]	Sets the DI input pattern to use for model registration. Enabled when <i>DI Register</i> is set to <i>Subtraction mode</i> .
Sub./Reg. Set	<ul style="list-style-type: none"> • [Register model] • Subtract 	Selects which one, model registration or difference extraction, should be performed at the next measurement. Enabled when <i>Subtraction mode</i> is set to <i>Subt./Reg.</i>



Precautions for Correct Use

When the operation mode is Double Speed Multi-input mode or Non-stop Adjustment mode, *Subtraction mode: Subt./Reg.* is not available.

- 3 Click **OK**.

3-12-3 Model (Image Subtraction)

Register the region to compare as a model. Usually, the background image (an image without objects to extract at measurement) is registered as the model.

- 1 In the Item Tab area, click **Model**.
- 2 In the *Model parameter* area, set model parameters.

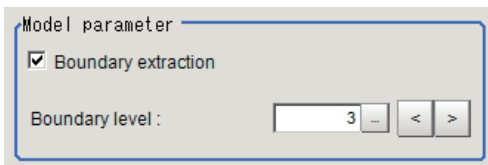

Setting item	Setting value [Factory default]	Description
Boundary inspection	<ul style="list-style-type: none"> • [Checked] • Unchecked 	<ul style="list-style-type: none"> • Checked: The different image is used as is. When the registered model and coated object can be captured at the exactly same position, there is no shift of images and therefore noises will not be generated due to difference extraction. In this case, more accurate measurement is possible when the difference image is used directly. • Unchecked Pixels corresponding to specified values are deleted from the outline of the extracted difference image. Set this to remove the noise generated by shifts between images when the inspection target object or camera slightly moves. As information of several pixels is deleted from the difference image, the coating width is finely measured compared to actual. <div style="text-align: center;"> <p>Measurement image</p> <p>If the measurement object moves up slightly, its difference with the model will be detected as the edge part.</p> <p>When setting Edge Measurement to "Disabled", the range of the "Model edge ± Boundary level" will be outside of the measurement object. Example) When "Edge level" is 3, the range with a width of 6 pixels will not be outside of the measurement object.</p> </div>

Setting item	Setting value [Factory default]	Description
Boundary level	0 to 9 [3]	Sets the degree of assimilation of variations around boundaries. The meaning varies depending on the <i>Boundary inspection</i> .



- 3 Click **Edit**.
- 4 Set the model registration range with the drawing tool.
- 5 Click **OK**.
 - **OK**: Changes the settings and returns to the previous menu.
 - **Cancel**: Changes are discarded and returns to the previous menu.
 - **Apply**: Updates the settings without leaving the edit window.

3-12-4 Disp. Image Sub. (Image Subtraction)

Set the method for extracting the difference images. Set this option when the difference cannot be extracted correctly such as when there are a lot of noises.

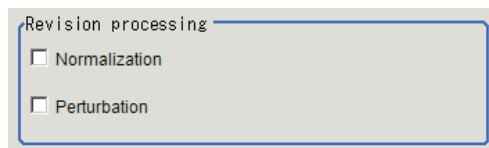
- 1 In the Item Tab area, click **Disp. image sub..**
- 2 In the *Revision processing* area, set each item.



Setting item	Setting value [Factory default]	Description
Normalization	<ul style="list-style-type: none"> • Checked • [Unchecked] 	<p>Select whether to perform normalization based on the brightness at the model registration.</p> <ul style="list-style-type: none"> • Checked Since the density is adjusted before difference extraction, the result is not affected by the lighting fluctuations or changes in the total image brightness. If normalization is performed on an objects with no pattern, the total image brightness is changed. Therefore, an image is not correctly extracted. <p style="text-align: center;">Model image</p> <div style="text-align: center;">  </div> <p style="text-align: center;">Measurement image (When the whole image turns dark)</p> <div style="display: flex; align-items: center; justify-content: center;"> <div style="text-align: center;">  </div> <div style="margin: 0 10px;"> Normalization processing → </div> <div style="text-align: center;">  </div> </div>

Setting item	Setting value [Factory default]	Description
Perturbation	<ul style="list-style-type: none"> • Checked • [Unchecked] 	<ul style="list-style-type: none"> • Checked Difference extraction is performed after correction, so that slight position deviation of measurement objects are not detected as error. However, the processing time becomes longer.

- 3** In the *Subtract parameter* area, set the difference judgement value.

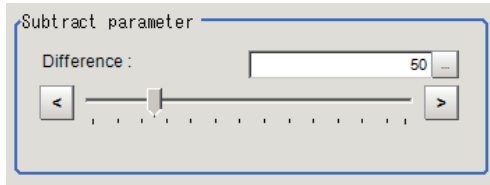

Setting item	Setting value [Factory default]	Description
Difference	0 to 255 [50]	Sets the reference grayscale used for calculating differences between the model and inspection target images. Pixels with a difference equal to or greater than <i>Difference</i> are converted to white and other pixels are converted to black, so that only defects are converted to white and measured.

3-12-5 Color (Image Subtraction)

Set the background color of the difference image (color of the parts not recognized as difference). Set this as necessary, such as the background color is similar to the extraction target object color and hard to find differences.

- 1** In the Item Tab area, click **Color**.
- 2** Specify the background color on the color chart.

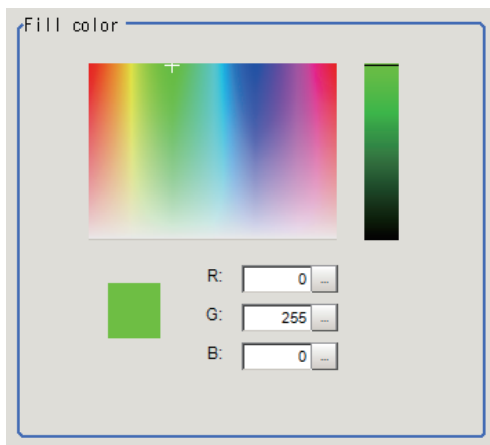

- 3** Finely adjust R, G, and B as necessary.

Setting item	Setting value [Factory default]	Description
R	0 to 255 [0]	Set a value for R (red).
G	0 to 255 [0]	Set a value for G (green).
B	0 to 255 [0]	Set a value for B (blue).

3-12-6 Key Points for Adjustment (Image Subtraction)

Adjust the setting parameters referring to the following points.

Affected by lighting fluctuation

Parameter to be adjusted	Remedy
Disp. image sub.	When affected by lighting change, turn ON the normalization. The density is adjusted before difference extraction, so that the extraction is not affected by changes in the total image brightness or the lighting fluctuation.

When the processing speed is slow

Parameter to be adjusted	Remedy
Model registration	Make the area to register as the model as small as possible.
Diff. image disp.	Turn OFF the perturbation processing.

When judgement is NG (insufficient memory)

Parameter to be adjusted	Remedy
Model registration	When the judgement is NG (insufficient memory), make the area to register as the model as small as possible.

3-12-7 Measurement Results for Which Output Is Possible (Image Subtraction)

The following values can be output using processing items related to result output. It is also possible to reference measurement values from calculation expressions and other processing units.

Measurement items	Character string	Description
Judge	JG	Judgment results 0: No judgment (unmeasured) 1: Judgment result OK -1: Judgment result NG -10: Error (image format mismatch) -11: Error (unregistered model) -12: Error (insufficient memory) -20: Error (other errors)

3-12-8 External Reference Tables (Image Subtraction)

No.	Data name	Data ident	Set/Get	Data range
0	Judge	judge	Get only	0: No judgment (unmeasured), 1: Judgment result OK, -1: Judgment result NG, -10: Error (image format mismatch), -11: Error (unregistered model), -12: Error (insufficient memory), -20: Error (other errors)
120	Boundary inspection	boundaryInspection	Set/Get	0: OFF, 1: ON
121	Boundary level	boundaryLevel	Set/Get	0 to 9
122	Normalization	normalization	Set/Get	0: OFF, 1: ON
123	Perturbation	perturbation	Set/Get	0: OFF, 1: ON
124	Difference	difference	Set/Get	0 to 255
125	Model Register Flag	modelRegister	Get only	0: OFF, 1: ON
126	Fill color R	colorR	Set/Get	0 to 255
127	Fill color G	colorG	Set/Get	0 to 255
128	Fill color B	colorB	Set/Get	0 to 255
130	Measure mode	modekind	Set/Get	0: Normal mode, 1: DI mode, 2: Changing mode
131	DI Register	DIcode	Set/Get	0 to 31
132	Changing Mode	changingmodekind	Set/Get	0: Register model 1: Difference extract
6,002	Format	cameraColor	Set/Get	1: Monochrome camera 2: Color camera

3-13 Advanced Filter

This item filters images captured from the camera to facilitate measurement. With advanced filter, up to 16 image filter libraries such as *Filtering*, *Color/Gray Filter*, and *Background Suppression* can be set and used in a single processing item. By combining image filters, highly flexible filter processing can be performed, and custom filters can be used to create your own customized filtering.

Used in the Following Cases

- When eliminating unnecessary background images from the measurement target:

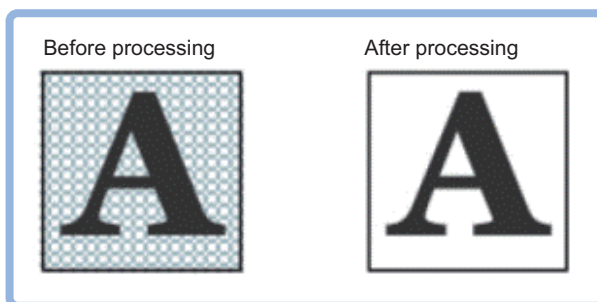

- When removing noise, uneven color, and image non-uniformity from the measurement target:

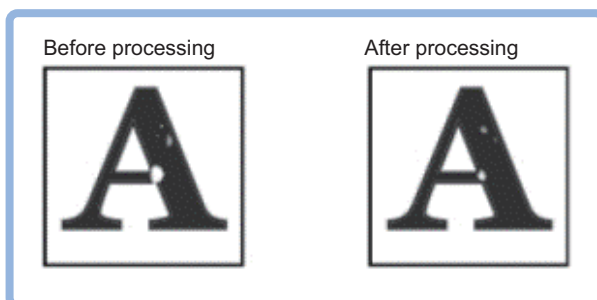

- When extracting only the measurement target object:

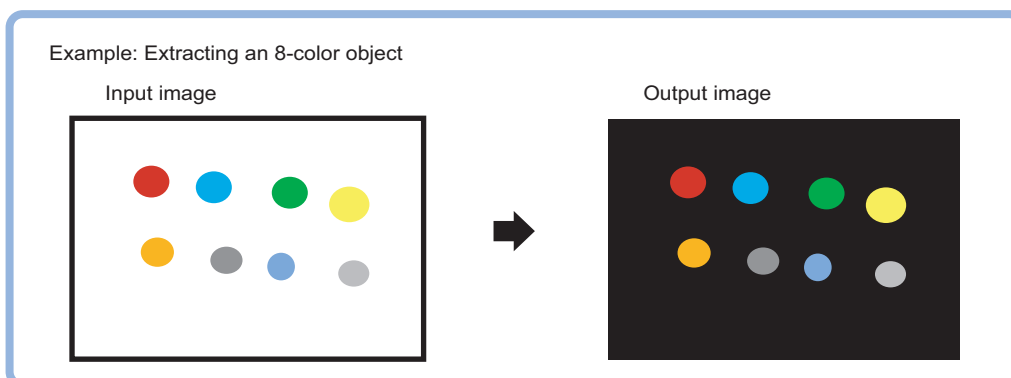

Precautions for Correct Use

Processing is different for color images and monochrome images. When the camera type used in the previous setup was changed to color or monochrome type, perform the settings again.

3-13-1 Settings Flow (Advanced Filter)

To set Advanced Filter, follow the steps below.

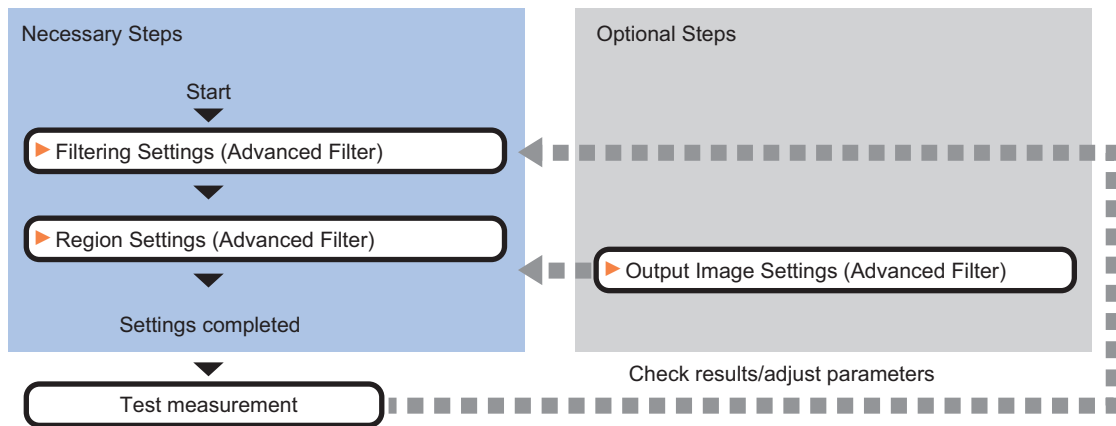





List of Advanced Filter Items

Item	Description
Filter setting	Filter images captured from the camera to facilitate measurement. The filtering method is selectable based on image conditions. <i>3-13-2 Filtering Settings (Advanced Filter) on page 3-75</i>
Region setting	Sets the measurement area. It is possible to target the entire screen, but restricting the range can shorten the processing time. <i>3-13-3 Region Settings (Advanced Filter) on page 3-118</i>
Output image	Set this when changing the output image settings. Specify an image to output as the measurement result. The specified image is available as the measurement image on other processing units in the measurement flow. <i>3-13-4 Output Image Settings (Advanced Filter) on page 3-118</i>

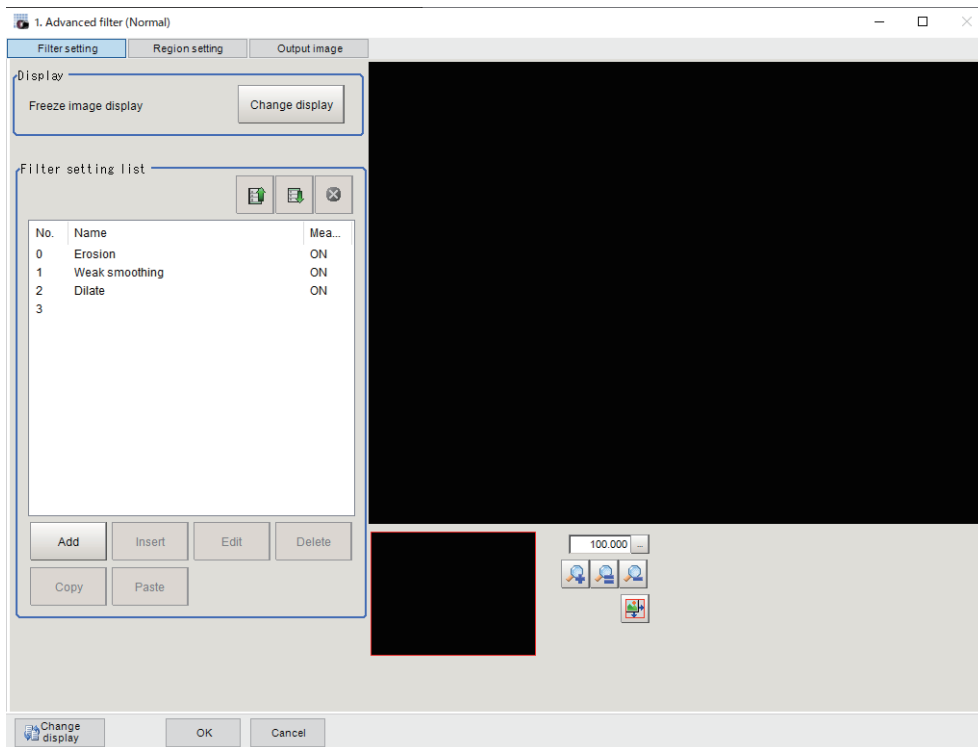
3-13-2 Filtering Settings (Advanced Filter)

Filter images captured from the camera to facilitate measurement. The filtering method is selectable for the image conditions.



Icon/Button	Function	Description
	Move UP	Moves the selected filter up one position.
	Move DOWN	Move the selected filter down one position.
	ON/OFF	Switch measurement ON or OFF for the selected filter.
Add button	Add	Add new filter to the end of the list.
Insert button	Insert	Insert new filter in to the selected position in the list.
Edit button	Edit	Edit the settings for the selected filter.
Delete button	Delete	Delete the selected filter.
Copy button	Copy	Copy the selected filter.
Paste button	Paste	Paste the copied filter in to the selected position in the list.

Adding a Filter

Select and add image filtering methods from the filter list.



Additional Information

Up to 16 filters can be added to the filter setting list.

- 1 In the Item Tab area, click **Filter setting**.
- 2 In the *Display* area, click **Change display** and select the type of camera image.
The display contents in the *Display* area is switched.

Setting item	Setting value [Factory default]	Description
Display	<ul style="list-style-type: none"> • Through image • [Freeze image] 	<ul style="list-style-type: none"> • Through image: The latest image is always loaded from the camera and displayed. • Freeze image: The image loaded in the immediately preceding measurement is displayed.

● Adding/Inserting filters selected from the List

When adding a filter newly, select and add the filter from the list.

- 1 In the *Filter setting list* area, click **Add**.
When inserting a filter in a selected position in the list, click **Insert**.
The *Select filter* screen is displayed.
- 2 In the *Select filter* screen, select the filter details to add.

Filter	Description
Weak smoothing	Same function as the weak smoothing filter in the <i>Filtering</i> processing item. Smoothes the image to reduce unevenness. Refer to <i>Changing the Filter Settings</i> on page 3-82.
Strong smoothing	Same function as the strong smoothing filter in the <i>Filtering</i> processing item. Smoothes the image to reduce unevenness. Refer to <i>Changing the Filter Settings</i> on page 3-82.
Guided Filter	Smoothing is performed while leaving edges. Refer to <i>Changing the Guided Filter Settings</i> on page 3-84.
Dilate	Same function as the dilate filter in the <i>Filtering</i> processing item. Dilates bright areas to reduce dark noise. Refer to <i>Changing the Filter Settings</i> on page 3-82.
Erosion	Same function as the erosion filter in the <i>Filtering</i> processing item. contract bright areas to reduce bright noise. Refer to <i>Changing the Filter Settings</i> on page 3-82.
Median	Same function as the median filter in the <i>Filtering</i> processing item. Reduces unevenness which maintaining the outline. Refer to <i>Changing the Filter Settings</i> on page 3-82.
Extract edges	Same function as the edge extraction filter in the <i>Filtering</i> processing item. Extracts edges (bright-dark) in images. Refer to <i>Changing the Filter Settings</i> on page 3-82.
Extract horizontal edges	Same function as the extract horizontal edges filter in the <i>Filtering</i> processing item. Extracts horizontal edges (bright-dark) in images. Refer to <i>Changing the Filter Settings</i> on page 3-82.
Extract vertical edges	Same function as the extract vertical edges filter in the <i>Filtering</i> processing item. Extracts vertical edges (bright-dark) in images. Refer to <i>Changing the Filter Settings</i> on page 3-82.

Filter	Description
Enhance edges	Same function as the enhance edges filter in the <i>Filtering</i> processing item. Enhances bright-dark edges in images. Refer to <i>Changing the Filter Settings</i> on page 3-82.
Prewitt	Edge filter similar to the extract edges filter in the <i>Filtering</i> processing item. Suppresses noise and extracts edges (bright-dark) in images. Refer to <i>Changing the Edge Filter Settings</i> on page 3-86.
Roberts	Edge filter similar to the extract edges filter in the <i>Filtering</i> processing item. Suppresses noise and extracts diagonal edges (bright-dark) in the image. Refer to <i>Changing the Edge Filter Settings</i> on page 3-86.
Laplacian	Edge filter similar to the extract edges filter in the <i>Filtering</i> processing item. Uniformly extracts edges (bright-dark) in the image. Refer to <i>Changing the Edge Filter Settings</i> on page 3-86.
LoG Filter	Filter specialized for monochrome images. This is a linear filter combining the functions of Smoothing and Edge detection, which can process stronger noise compared to the conventional edge detection filter. Refer to <i>Changing the LoG Filter Settings (Monochrome Images Only)</i> on page 3-87.
Background Suppression	Same function as the background suppression filter in the <i>Background Suppression</i> processing item. Parts of the image that are outside the specified bright-dark range are treated as background and suppressed. Refer to <i>Changing the Background Suppression Filter Settings</i> on page 3-89.
Brightness Correct Filter	Filter specialized for monochrome images. Same function as the brightness correct filter in the <i>Brightness Correct Filter</i> processing item. Compensates the effects of lighting as well as properties of measurement objects such as material and shape. Refer to <i>Changing the Brightness Correct Filter Settings (Monochrome Images Only)</i> on page 3-91.
Stripes Removal Filter II	Filter specialized for monochrome images. Same function as the stripes removal filter in the <i>Stripes Removal Filter II</i> processing item. Removes a striped background. Refer to <i>Changing the Stripes Removal Filter II Settings (Monochrome Images Only)</i> on page 3-92.
Labeling Filter	Binarizes images based on the same extraction conditions as the Labeling processing item. Refer to <i>Changing the Labeling Filter Settings</i> on page 3-93.
Custom Linear Filter	Sets the custom filter coefficients. Selects a filter count, filter size, offset, and so on for filtering. Refer to <i>Changing the Custom Linear Filter Settings</i> on page 3-99.
Custom Rank Filter	Sets the custom filter coefficients. Selects a filter count, filter size, offset, and so on for filtering. Refer to <i>Changing the Custom Rank Filter Settings</i> on page 3-100.
Image Operation	Converts images by calculating pixel values. Refer to <i>Changing the Image Operation Filter Settings</i> on page 3-101.
2 Images Operation	Converts images by calculating the paired pixel values of two images. Refer to <i>Changing the Image Operation Filter Settings</i> on page 3-101.

Filter	Description
Binary Filter	Filter specialized for monochrome images. Binarizes images. Refer to <i>Changing the Binary Filter Settings (Monochrome Images Only)</i> on page 3-105.
Color Gray Filter	Filter specialized for color images. Same function as the color gray filter in the <i>Color Gray Filter</i> processing item. Converts color images to monochrome images. Refer to <i>Changing the Color Gray Filter Settings (Color Images Only)</i> on page 3-106.
Extract Color Filter	Filter specialized for color images. Same function as the extract color filter in the <i>Extract Color Filter</i> processing item. Extracts color from color images. Refer to <i>Changing the Extract Color Filter Settings (Color Images Only)</i> on page 3-107.
Anti-Color Shading	Filter specialized for color images. Same function as the anti-color shading filter in the <i>Anti-Color Filter</i> processing item. Removes uneven color in images. Refer to <i>Changing the Anti-Color Shading Filter Settings (Color Images Only)</i> on page 3-109.
Emphasis Defect	Filter specialized for monochrome images. Emphasizes defects by comparing pixels at the center with surrounding area. Changes the defect filter settings. Refer to <i>Changing the Emphasis Defect Filter Settings (Monochrome Images Only)</i> on page 3-110.
Emphasis Unevenness	Filter specialized for monochrome images. Generates an image with the high brightness contrast from an input image and emphasizes unevenness. Refer to <i>Changing the Emphasis Unevenness Filter Settings (Monochrome Images Only)</i> on page 3-113.
Emphasis Line Defect	Filter specialized for monochrome images. Emphasizes line defects of low brightness. Changes the emphasis line defect filter settings. Refer to <i>Changing the Emphasis Line Defect Filter Settings (Monochrome Images Only)</i> on page 3-114.
Emphasis Circle Defect	Filter specialized for monochrome images. Emphasizes circular defects of low brightness. Changes the emphasis circle defect filter settings. Refer to <i>Changing the Emphasis Circle Defect Filter Settings (Monochrome Images Only)</i> on page 3-116.

- 3** Click **OK**.
The selected filter is added to the end of list in the *Filter setting list* area.
When adding the filter by clicking **Insert**, the filter is inserted to the selected position in the list.
- 4** Select the filter in the list in the *Filter setting list* area.
- 5** Click **Edit**.
For details, refer to *Changing the Filter Settings* on page 3-80.

● Adding a copy of an already-set filter

When using filter settings of a filter that has been added in the list of the *Filter setting list* area, copy the settings and add the filter.

- 1** In the list of the *Filter setting list* area, select the filter to copy.
- 2** Click **Copy**.
Paste is enabled.
- 3** In the list of the *Filter setting list* area, select the filter number to insert.
- 4** Click **Paste**.
The copied filter is inserted in the list of the *Filter setting list* area.

Changing the order of a filter

Change the order of a filter displayed in the *Filter setting list* area.

- 1** In the *Filter setting list* area, select the filter you wish to change the order for.
- 2** Click the **Move UP** icon or the **Move DOWN** icon.
The selected filter is moved by one position.

Disabling a filter

Disable a filter selected in the *Filter setting list* area.

- 1** In the *Filter setting list* area, select the filter you wish to disable.
- 2** Click the **ON/OFF** icon.
The **Measure** column for the selected filter changes to **OFF**.
- 3** If you wish to enable measurement for the filter, click the **ON/OFF** icon again.
The **Measure** column for the selected filter changes to **ON**. The filter is enabled.

Deleting a Filter

Delete a filter that has been added to the list.

- 1** In the list of the *Filter setting list* area, select the filter to delete.
- 2** Click **Delete**.
The *Deletion confirmation* dialog is displayed.
- 3** In the *Deletion confirmation* dialog, click **OK**.

The selected filter is deleted from the **Filter setting list**.

Changing the Filter Settings

Changes the added filter settings.

The setting screen varies dependin on the filter.

- 1** In the list of the *Filter setting list* area, select the filter to change the settings.
- 2** Click **Edit**.
The filter edit screen is displayed.
- 3** In the **Filter target** area, set the target image(s).
 - Normal filter setting screen:

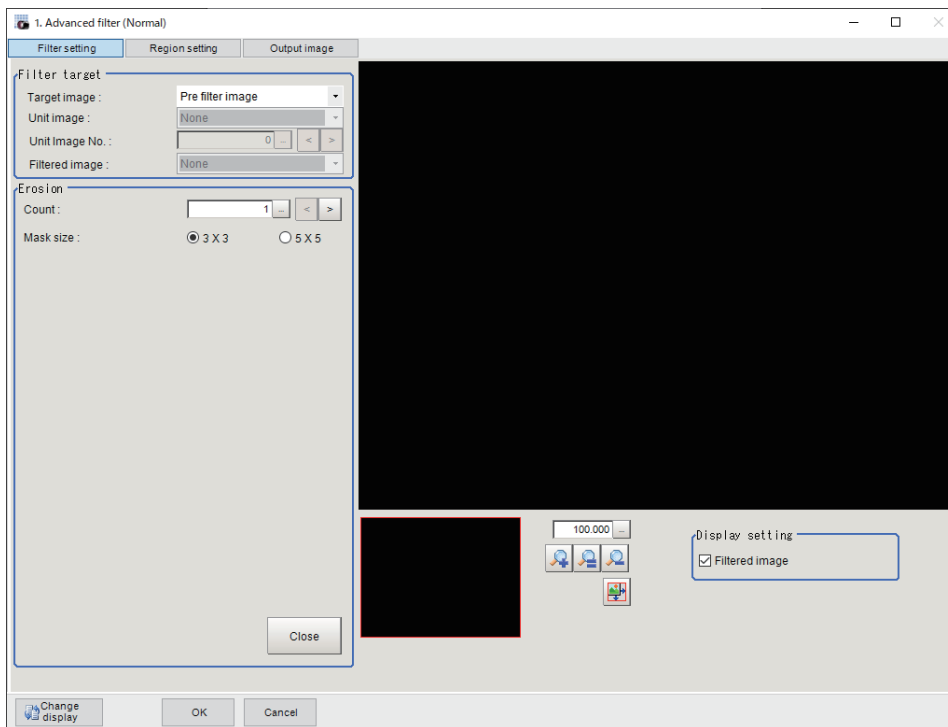

Setting item	Setting value [Factory default]	Description
Target image	<ul style="list-style-type: none"> • Measurement image • [Prev. filter image] • Other unit image • Filtered image 	<p>Sets which images are filtered as the <i>Target image</i>.</p> <ul style="list-style-type: none"> • Measurement image Filters the measurement image for the processing unit. • Prev. filter image Filters the previously processed image. • Other unit image Filters a processing unit image held by another processing unit. • Filtered image Filters the filtered processing image specified by the filter number in the filter setting list.

Setting item	Setting value [Factory default]	Description
Unit image	<ul style="list-style-type: none"> [None] 0 to 9,999 	<p>This one is available when <i>Other unit image</i> is selected in the <i>Target image</i>.</p> <p>Sets the processing unit that holds the image to be used as the target image. A processing unit in Image Input or Image Conversion related processing items is selectable. If the selected processing unit does not hold an image, it becomes an invalid image and a black image is displayed.</p>
Unit image number	0 to 3 [0]	<p>This one is available when <i>Other unit image</i> is selected in the <i>Target image</i>.</p> <p>Sets the image number of the image to use as the target image. If the processing unit does not hold the image set by the image number, it becomes an invalid image and a black image is displayed.</p>
Filtered image	<ul style="list-style-type: none"> [None] 0 to 14 	<p>Enabled when <i>Filtered image</i> is selected in the <i>Target image</i>.</p> <p>Sets the processing unit to hold the image to be used as the target image. Selects a processing unit prior to this processing unit in the measurement flow.</p>

- 2 images operation filter setting screen:

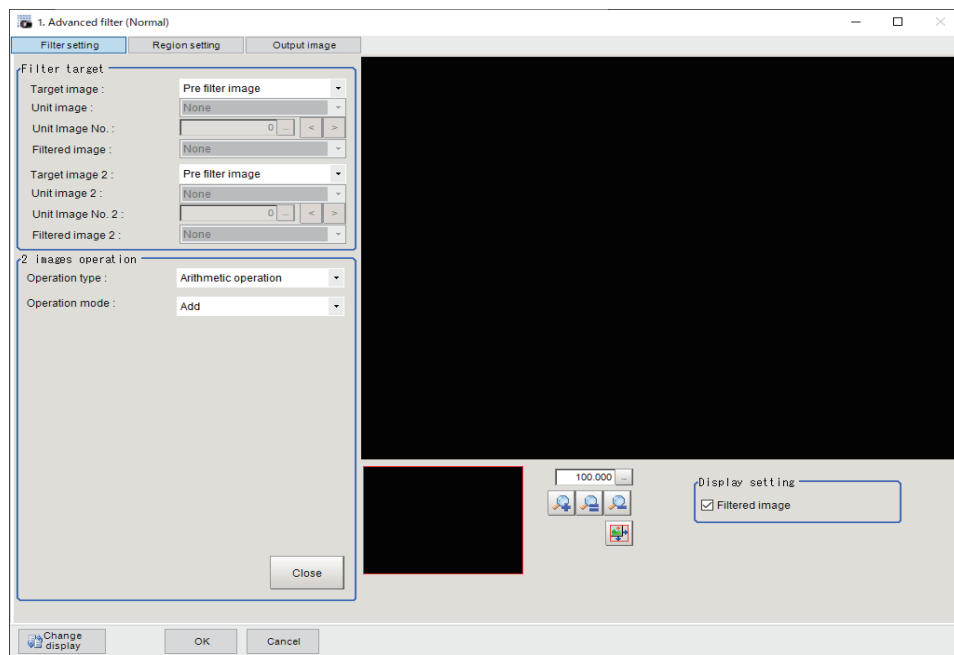

Setting item	Setting value [Factory default]	Description
Target image2	<ul style="list-style-type: none"> Measurement image [Prev. filter image] Other unit image Filtered image 	<p>Enabled when <i>2 images operation filter</i> is selected in <i>Filter Setting</i>.</p> <p>As target image 2, set which image is used for operating with the target image.</p> <p>The selectable value is the same as <i>Target image</i>.</p>

Setting item	Setting value [Factory default]	Description
Unit image2	<ul style="list-style-type: none"> [None] 0 to 9,999 	Enabled when <i>Filter setting</i> is <i>2 images operation filter</i> and <i>Processing unit image</i> is selected in <i>Target image 2</i> . Sets the processing unit holding an image used as target image 2. Sets the processing unit that holds the image to be used as the target image. A processing unit in Image Input or Image Conversion related processing items is selectable. If the selected processing unit does not hold an image, it becomes an invalid image and a black image is displayed.
Unit image number 2	0 to 3 [0]	Enabled when <i>Filter setting</i> is <i>2 images operation filter</i> and <i>Processing unit image</i> is selected in <i>Target image 2</i> . Sets the image number of the image used as target image 2. If the processing unit does not hold the image set by the image number, it becomes an invalid image and a black image is displayed.
Filtered image 2	<ul style="list-style-type: none"> [None] 0 to 14 	This option is available when <i>Filter setting</i> is <i>2 Images Operation Filter</i> and <i>Filtered image</i> is selected in <i>Target image 2</i> . Sets the processing unit holding the image used as target image 2. Selects a processing unit prior to this processing unit in the measurement flow.

4 In the filter edit area, set each filter parameters.

● Changing the Filter Settings

Change the settings of a filter equivalent to the *Filtering* processing item.

Weak smoothing, Strong smoothing, Dilate, Erosion, Median, Extract edges, Extract horizontal edges, Extract vertical edges, or Enhance edges filter settings are edited.

For details, refer to *Filtering Options and Examples* on page 3-11 in the *3-2 Filtering* on page 3-9.

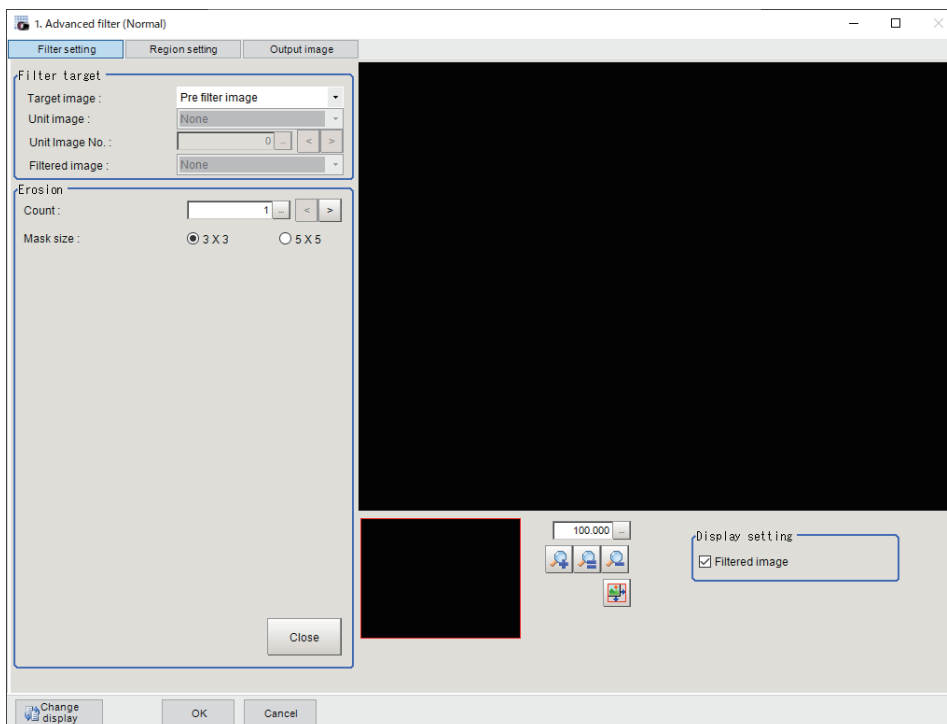

Setting item	Setting value [Factory default]	Description
Count	1 to 9 [1]	Sets the number of times that the filter is applied.
Mask size	<ul style="list-style-type: none"> • [3×3] • 5×5 	<p>Sets the mask size of the filter.</p> <p>When the variation in the brightness of peripheral pixels is large, increase the <i>Mask size</i> setting.</p>
Filtered image	<ul style="list-style-type: none"> • [Checked] • Unchecked 	Checked: Displays the filtered image.

● **Changing the Guided Filter Settings**

Perform smoothing processing while leaving edges. Smooth non-edge parts strongly while judging edges.

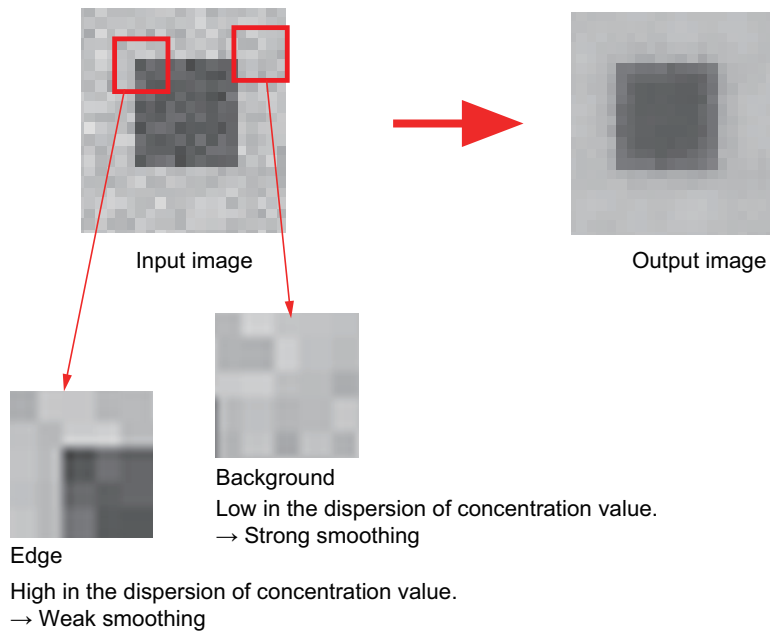

Adjust parameters while checking edges you want to keep.

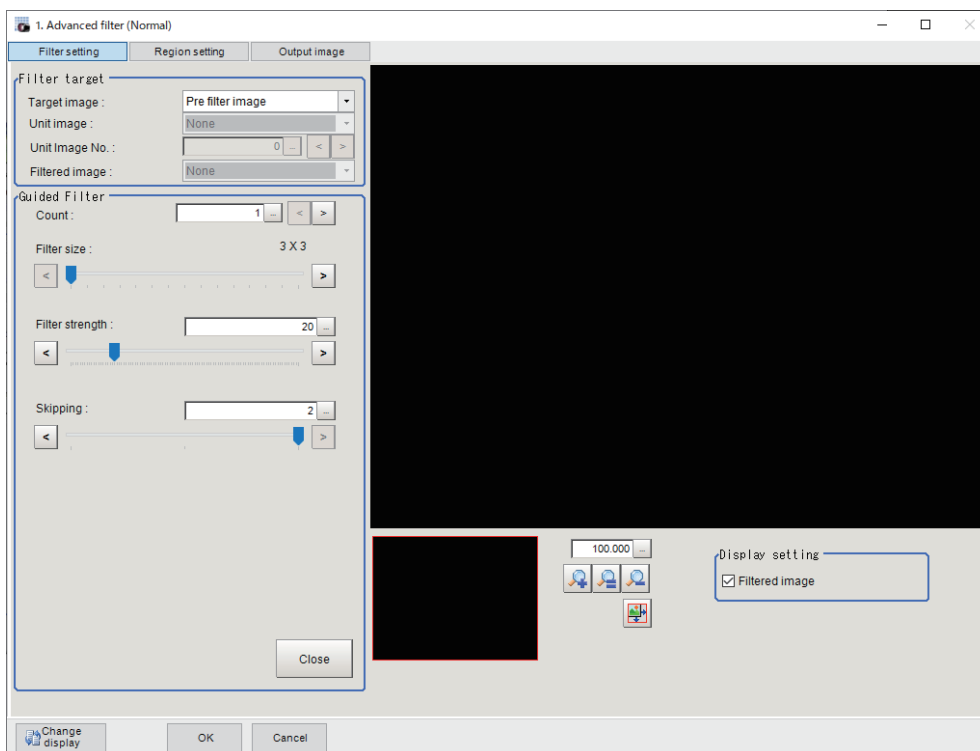

Setting item	Setting value [Factory default]	Description
Count	1 to 9 [1]	Sets the number of times that the filter is applied. The filter is applied for the number of times specified.

Setting item	Setting value [Factory default]	Description
Filter size	3×3 to 31×31 [3×3]	With the number of pixels, set the Filter size. Increasing the value makes the effect of smoothing bigger but the processing time is longer.
Filter strength	1 to 100 [20]	Adjust the degree to leave edges. Increasing the value makes edges smooth too. Setting this to 100 gives almost same effect as normal smoothing filter.
Skipping	0 to 2 [2]	Adjust the degree to speed up the processing speed. Increasing the value shortens the processing time, but fine edges might not remain even if the Filter strength was set to low.
Filtered image	<ul style="list-style-type: none"> • [Checked] • Unchecked 	Checked: Displays the filtered image.



Additional Information

- In the end of a measuring region, the filtering is not executed and an input image is output. When you want to narrow the non-processing area, decrease the **Filter size** value.
- To shorten the processing time, do the following.
 - Reduce the measuring region
 - Reduce the **Filter size** value
 - Increase the **Skipping** value

● Changing the Edge Filter Settings

Change the settings of a edge filter similar to the extract edges filter in the *Filtering* processing item. (3-2 *Filtering* on page 3-9)

The following setting screen appears when the settings of *Prewitt*, *Roberts*, or *Laplacian* are edited.

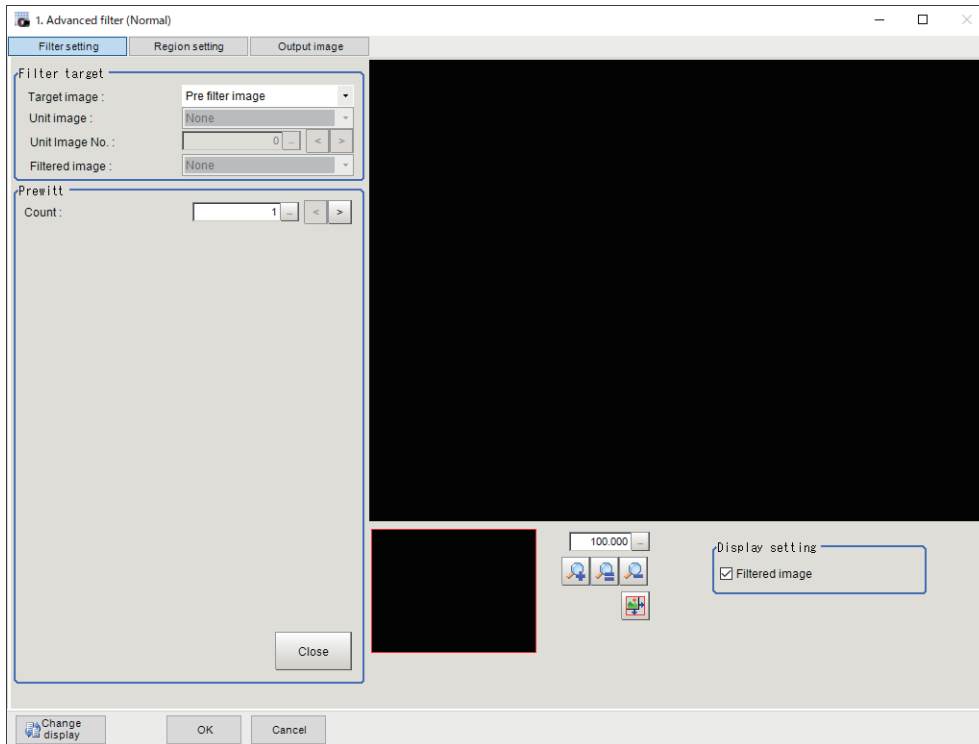

Setting item	Setting value [Factory default]	Description
Count	1 to 9 [1]	Sets the number of times that the filter is applied.
Filtered image	<ul style="list-style-type: none"> • [Checked] • Unchecked 	Checked: Displays the filtered image.

● Changing the LoG Filter Settings (Monochrome Images Only)

The LoG (Laplacian of Gaussian) filter is a type of edge emphasis filters.

The LoG filter is a linear filter combining functions of Smoothing (Gaussian filter) and Edge detection (Laplacian filter), which can process stronger noise compared to the conventional edge detection filters.

The Gaussian filter is a smoothing filter making the smoothing weight larger the closer it is to the target pixel.

The Laplacian filter is a edge detection filter using the second derivative.

Edges are extracted by the Laplacian filter after reducing noise by the Gaussian filter.

The LoG filter reduces noise with a Gaussian filter and then extracts edges with a Laplacian filter.

Adjust parameters while checking edge strength to extract.

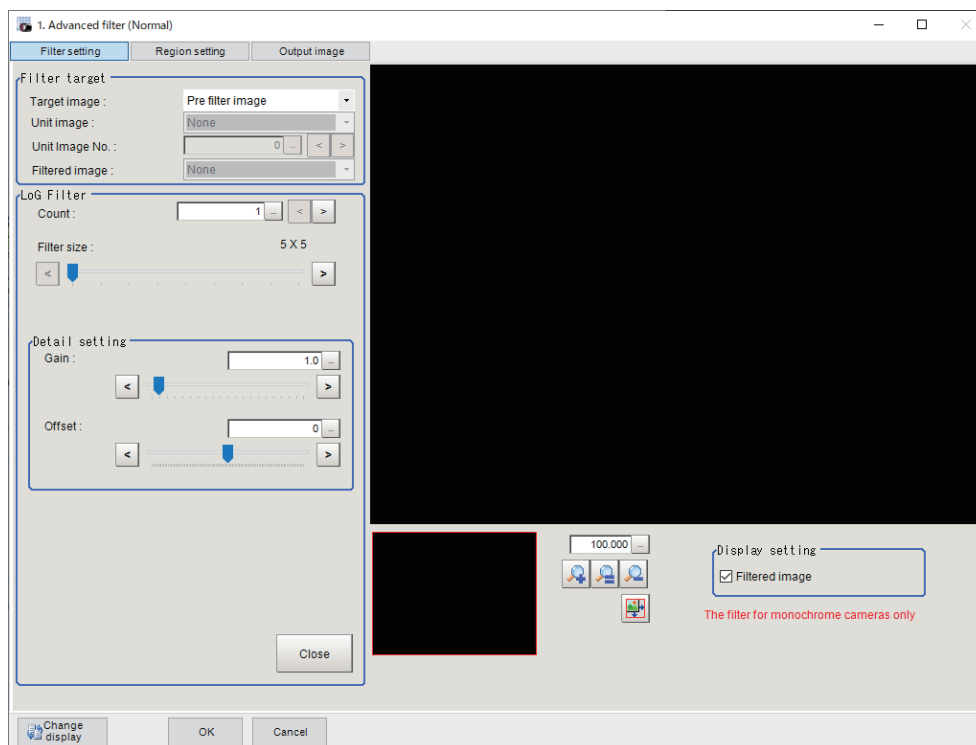

Setting item	Setting value [Factory default]	Description
Count	1 to 9 [1]	Sets the number of times that the filter is applied. The filter is applied for the number of times specified.
Filter size	5×5 to 21×21 [5×5]	With the number of pixels, set the Filter size. Increasing the value makes the effect of smoothing bigger but the processing time is longer.
Gain	0.1 to 20.0 [1.0]	Set the image brightness using magnification. Make the dark region in the image easier to see by increasing the value.
Offset	-255 to 255 [0]	Add brightness (concentration value) to an image. Increasing the value lightens an image.
Filtered image	<ul style="list-style-type: none"> • [Checked] • Unchecked 	Checked: Displays the filtered image.



Additional Information

- In the end of a measuring region, the filtering is not executed and an input image is output. When you want to narrow the non-processing area, decrease the **Filter size** value.
 - If it is loading an image from a color camera, the input image is not displayed. When filtering an image of a color camera, add the *Color Gray Filter* and then apply this filter to it after converting the image.
 - To shorten the processing time, do the following.
 - Reduce the measuring region
 - Reduce the **Filter size** value
-

● Changing the Background Suppression Filter Settings

Change the settings of a filter equivalent to *Background Suppression* processing item. (3-3 *Background Suppression* on page 3-14)

- For color images:

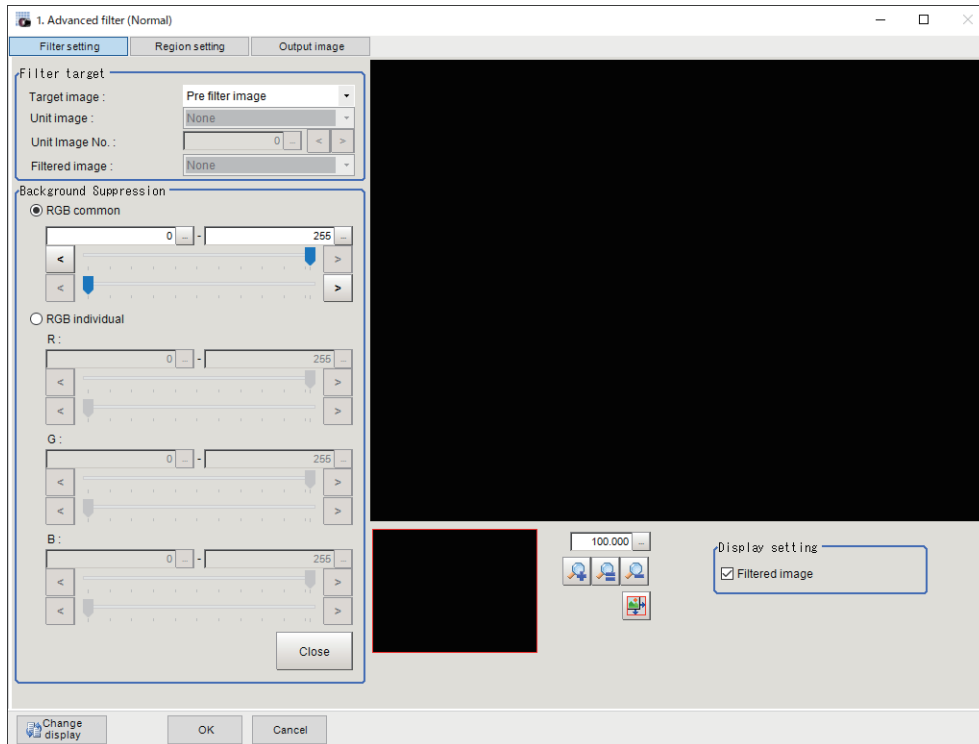

Setting item	Setting value [Factory default]	Description
RGB common/ RGB individual	<ul style="list-style-type: none"> • [RGB common] • RGB individual 	Selects whether to set the upper and lower limits of RGB as RGB common or RGB individual.
RGB common	0 to 255 [0] to [255]	Enabled when <i>RGB common</i> is selected in <i>RGB common/RGB individual</i> Sets the upper and lower values for the background suppression level. The range set from the minimum to the maximum values is converted to 0 to 255.
RGB individual	0 to 255 [0] to [255]	Enabled when <i>RGB individual</i> is selected in <i>RGB common/RGB individual</i> Sets the upper and lower values for the background suppression level individually. The range set from the minimum to the maximum values is converted to 0 to 255.
Filtered image	<ul style="list-style-type: none"> • [Checked] • Unchecked 	Checked: Displays the filtered image.

- For monochrome images:

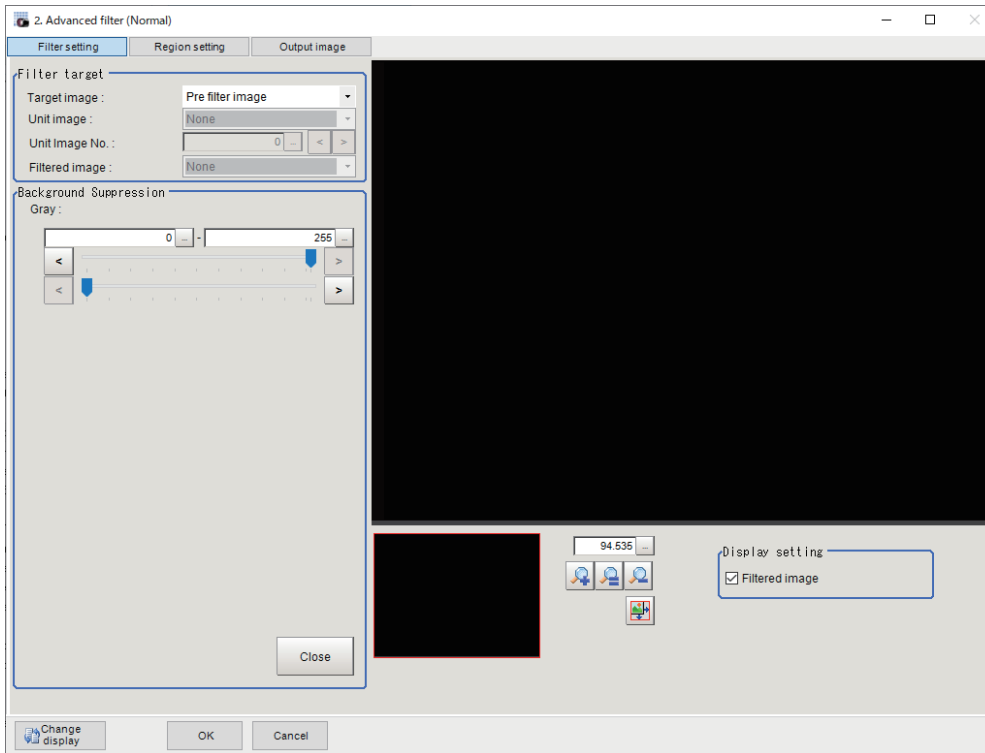

Setting item	Setting value [Factory default]	Description
Gray	0 to 255 [0] to [255]	Sets the upper and lower limit values of the density in the background suppression level. The set range from the lower to upper limits is converted to 0 to 255 gradation levels.
Filtered image	<ul style="list-style-type: none"> • [Checked] • Unchecked 	Checked: Displays the filtered image.

● Changing the Brightness Correct Filter Settings (Monochrome Images Only)

Change the settings of a filter equivalent to *Brightness Correct* processing item. (3-3 Background Suppression on page 3-14)

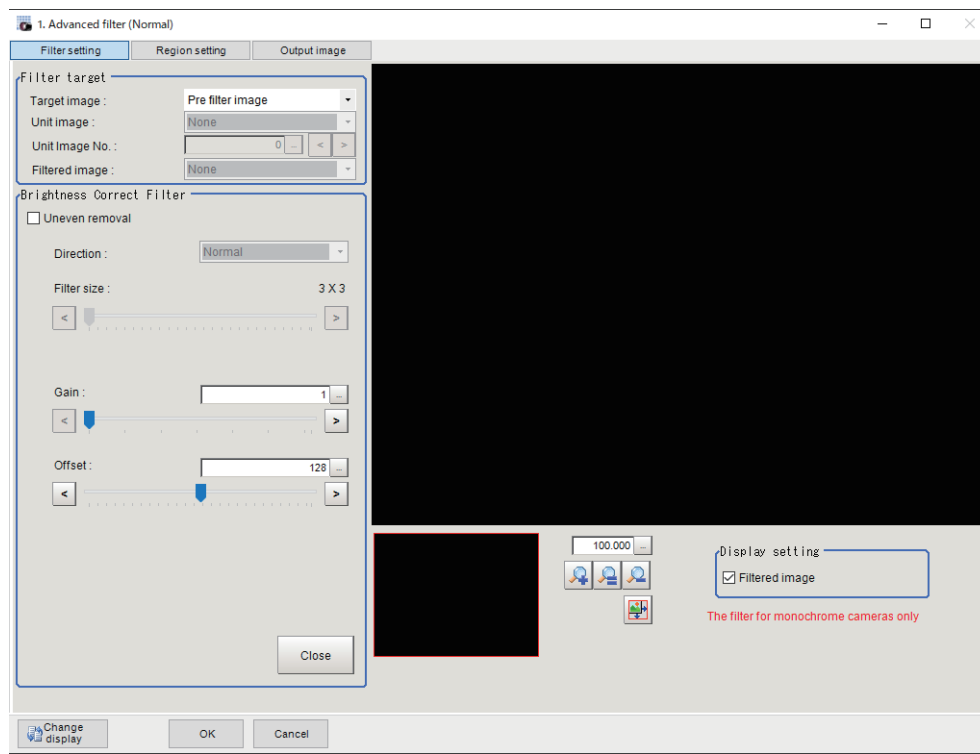

Setting item	Setting value [Factory default]	Description
Uneven removal	<ul style="list-style-type: none"> • Checked • [Unchecked] 	Places a check to <i>Uneven removal</i> when removing dark/bright unevenness with brightness correction.
Direction	<ul style="list-style-type: none"> • [Normal] • Vertical • Horizontal 	Enabled when the checkbox of <i>Uneven removal</i> is checked. Sets the direction to filter images. Set the filter direction as perpendicular to the direction of the changes in the darkness and brightness of the unevenness.
Filter size	3×3 to 255×255 [3×3]	Enabled when the checkbox of <i>Uneven removal</i> is checked. Sets the size of filter mask with an odd numeric value. Increase the <i>Filter size</i> when the size of the unevenness is large.
Gain	1 to 63 [1]	Adjusts the contrast of an image after correction. Increasing the value emphasizes the concentration differences in images.
Offset	0 to 255 [128]	Adjusts the brightness of an image after correction. Increasing the value makes images brighter.
Filtered image	<ul style="list-style-type: none"> • [Checked] • Unchecked 	Checked: Displays the filtered image.

● Changing the Stripes Removal Filter II Settings (Monochrome Images Only)

Change the settings of a filter equivalent to *Stripes Removal Filter II* processing item. (3-8 *Stripes Removal Filter II* on page 3-40)

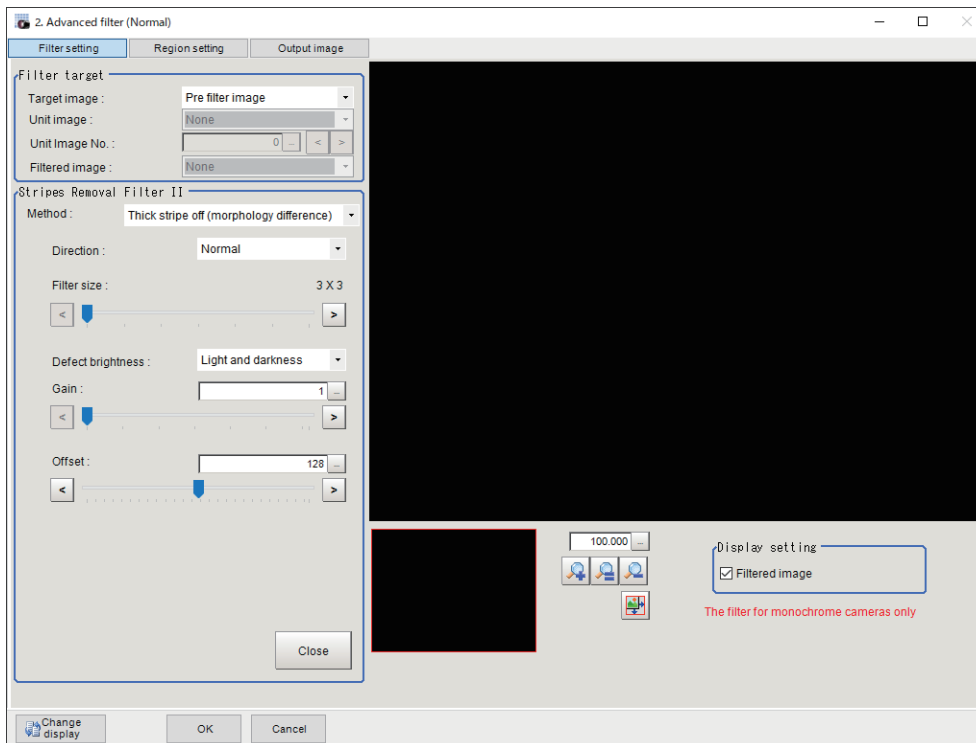

Setting item	Setting value [Factory default]	Description
Method	<ul style="list-style-type: none"> [Thick stripe off(morphology difference)] Pinstripe off(morphology) 	<p>Sets the correction method.</p> <ul style="list-style-type: none"> Thick stripe off(morphology difference) Sets the filter size based on the size of the expected defect and removes the striped patterns. Pinstripe off(morphology) Sets the filter size based on the width of the stripes and removes the striped patterns.
Direction	<ul style="list-style-type: none"> [Normal] Vertical Horizontal Upper right Lower right 	<p>Sets the direction to filter images.</p> <p>Set the filter direction as perpendicular to the direction of the changes in the darkness and brightness of the unevenness.</p>
Filter size	3×3 to 63×63 [3×3]	<p>Sets an odd numeric value for the size to filter stripes and defects.</p> <p>Thick stripe off (morphology difference): Set the <i>Filter size</i> larger than that of stripes and defects to detect.</p> <p>Pinstripe off (morphology): Set the <i>Filter size</i> larger than the width of the striped pattern to detect.</p>
Defect brightness	<ul style="list-style-type: none"> [Light and darkness] Light Darkness 	<p>Enabled when <i>Thick stripe off (morphology difference)</i> is selected in the <i>Correction method</i>.</p> <p>Sets the brightness of defects to be extracted from the background of it.</p> <p>When detecting both white and black defects, select <i>Light and darkness</i>.</p>

Setting item	Setting value [Factory default]	Description
Stripe brightness	<ul style="list-style-type: none"> [Light and darkness] Light Darkness 	Enabled when <i>Pinstripe off (morphology)</i> is selected in the <i>Correction method</i> . Sets the brightness of the stripes to cut. Set <i>Light</i> when the stripes are brighter than the background.
Gain	1 to 63 [1]	Enabled when <i>Thick stripe off (morphology difference)</i> is selected in the <i>Correction method</i> . Adjusts the contrast of an image after correction. Increasing the value emphasizes the concentration differences in images.
Offset	0 to 255 [128]	Enabled when <i>Thick stripe off (morphology difference)</i> is selected in the <i>Correction method</i> . Adjusts the brightness of an image after correction. Increasing the value makes images brighter.
Filtered image	<ul style="list-style-type: none"> [Checked] Unchecked 	Checked: Displays the filtered image.

● Changing the Labeling Filter Settings

Change the settings of a filter binarizing images with the same extraction conditions as the *Labeling* processing item. (2-21 *Labeling* on page 2-317)

- Color extraction settings screen for color images:

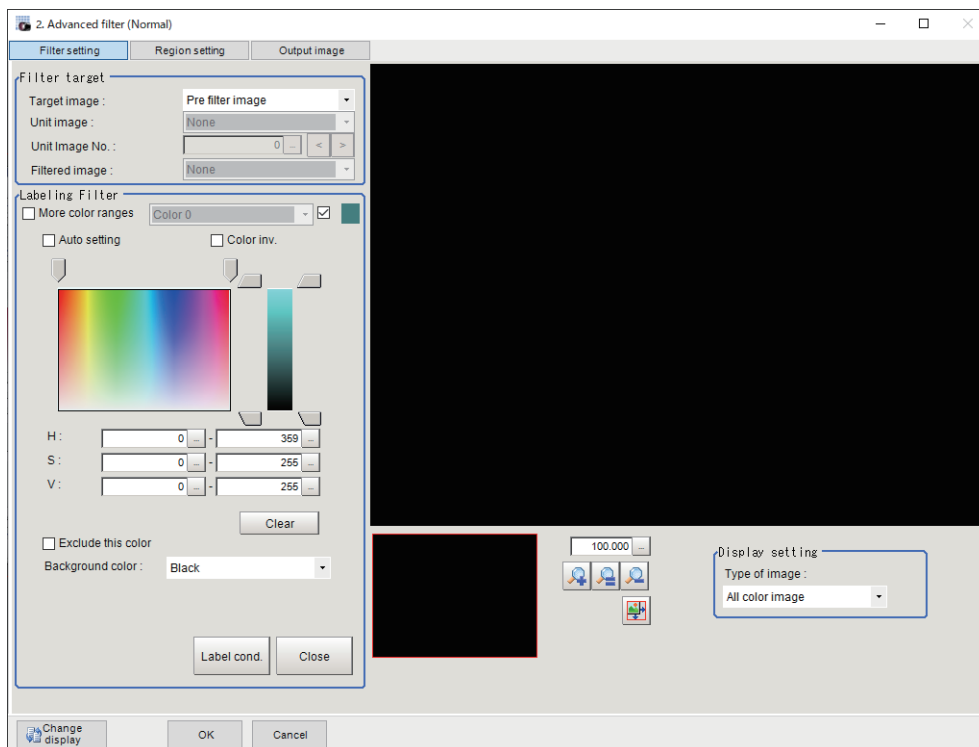

Setting item	Setting value [Factory default]	Description
More color ranges	<ul style="list-style-type: none"> Checked [Unchecked] 	Places a check to the <i>More color ranges</i> when extracting multiple colors.
Color extraction range	Color 0 to Color 7 [Color 0]	Enabled when <i>More color ranges</i> are checked. Sets the color ranges to extract.

Setting item	Setting value [Factory default]	Description
Select	<ul style="list-style-type: none"> • [Checked] • Unchecked 	Enabled when <i>More color ranges</i> are checked. Places a check to the <i>Select</i> when extracting color using the range selected in the <i>Color extraction range</i> .
Automatic	<ul style="list-style-type: none"> • Checked • [Unchecked] 	Places a check to the <i>Auto setting</i> when setting color specified on an image as the measurement target color.
Color inv.	<ul style="list-style-type: none"> • Checked • [Unchecked] 	Places a check to the <i>Color inv.</i> when measuring color other than the color specified.
H	0 to 359 [0] to [359]	Sets the hue (difference in hue).
S	0 to 255 [0] to [255]	Sets the saturation (difference in saturation).
V	0 to 255 [0] to [255]	Sets the vividness (difference in vividness).
Clear button	-	Restores the color set in the above parameters to the default when clicking this button.
Exclude this color	<ul style="list-style-type: none"> • Checked • [Unchecked] 	Places a check to the <i>Exclude this color</i> when excluding the color range selected in <i>Color extraction range</i> from the extracting target.
Background color	<ul style="list-style-type: none"> • [Black] • White • Red • Green • Blue 	Sets the color used to fill background color parts other than the color to be extracted. When <i>Color selected image</i> is selected in <i>Type of image</i> , the background color can be set for each selected color. When <i>All color image</i> is selected in <i>Type of image</i> , the background color parts are filled with the background color of Color 0.
Type of image	<ul style="list-style-type: none"> • Measurement image • [All color image] • color selected image • Binary image 	Sets the image to display in the settings screen.

- Binarization settings screen for monochrome images:

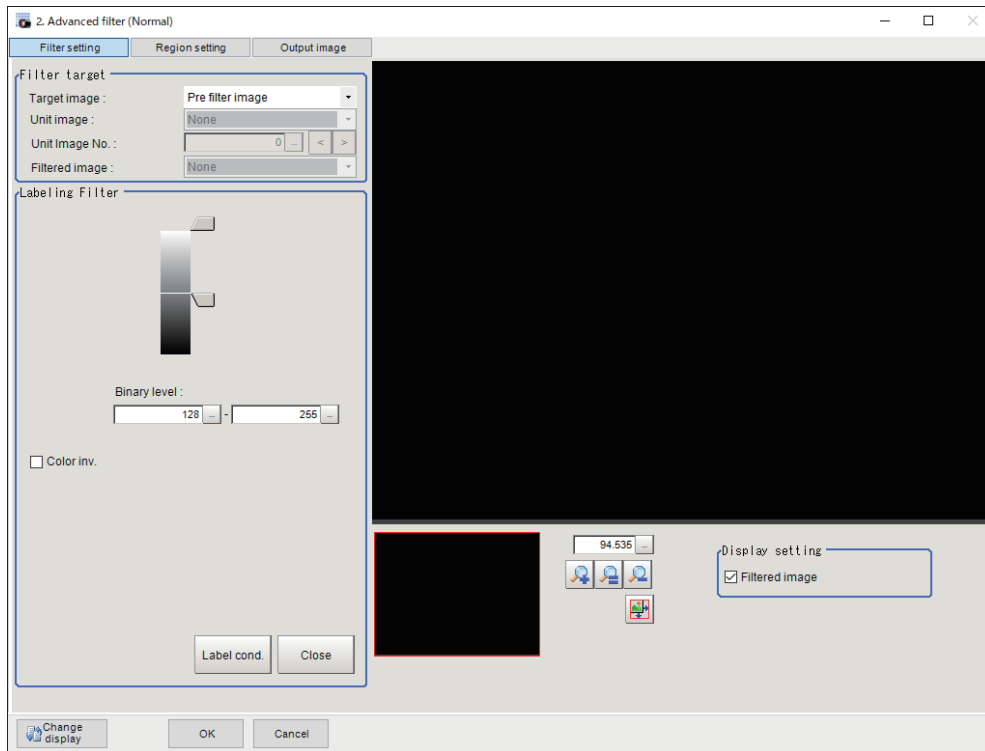

Setting item	Setting value [Factory default]	Description
Binary level	0 to 255 [128] to [255]	Sets a level to convert 256-gradation images to binary images. Set <i>Binary level</i> so that the measurement object becomes white pixels.
Color inv.	<ul style="list-style-type: none"> • Checked • [Unchecked] 	Places a check to <i>Color inv.</i> when reversing white and black.
Filtered image	<ul style="list-style-type: none"> • [Checked] • Unchecked 	Checked: Displays the filtered image.

- Label condition settings screen for color images

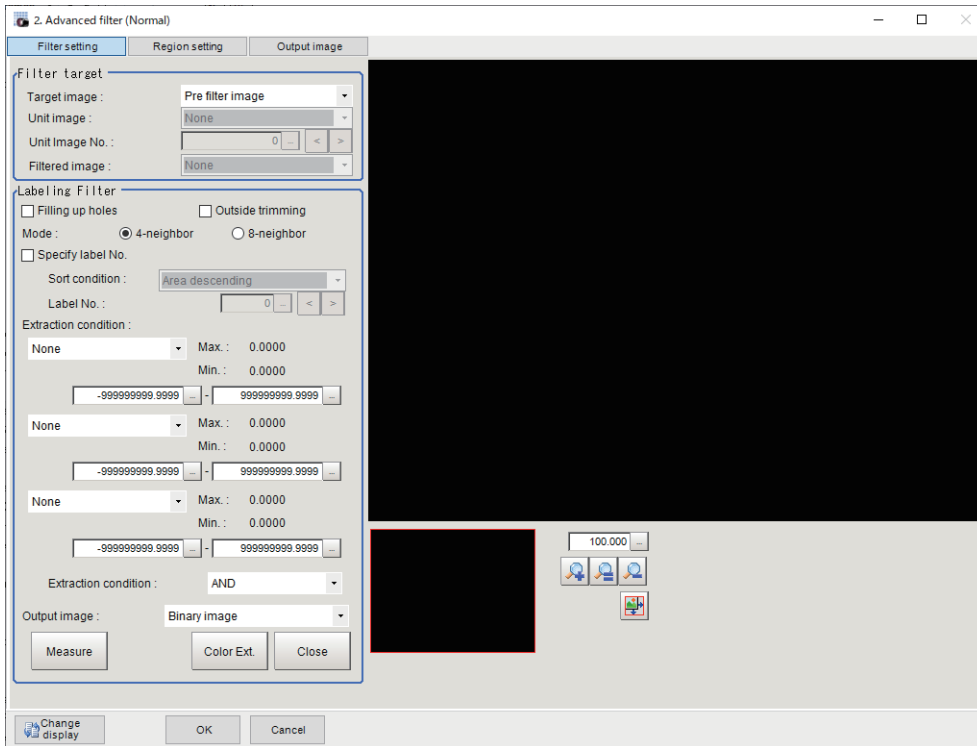

- Label condition settings screen for monochrome images

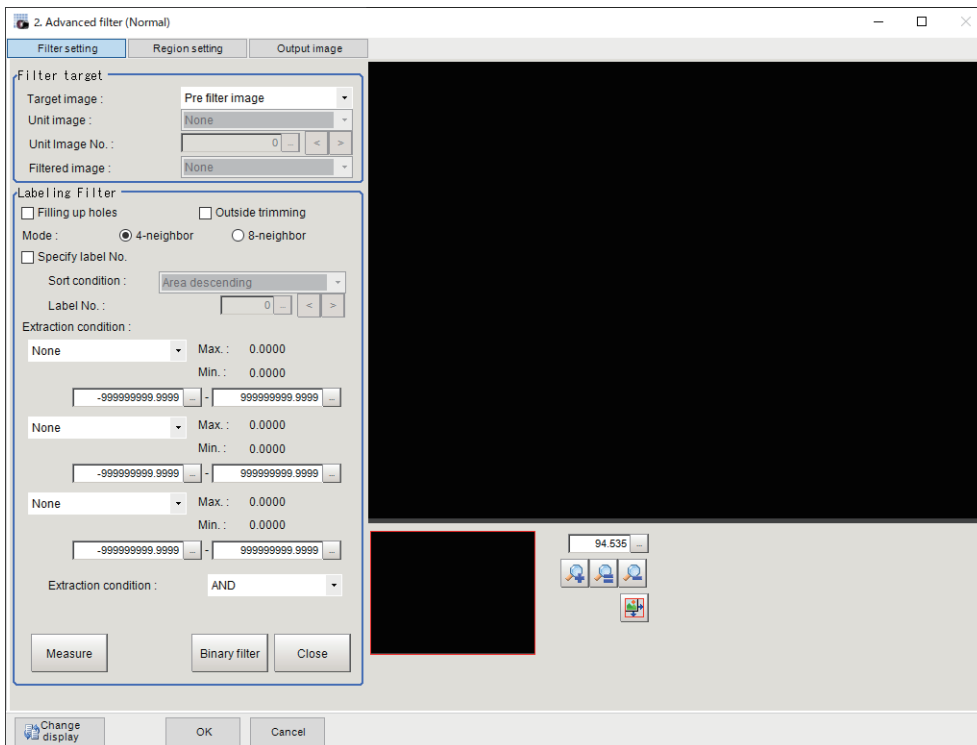

Setting item	Setting value [Factory default]	Description
Filling up holes	<ul style="list-style-type: none"> • Checked • [Unchecked] 	Places a check to Filling up holes, when filling a blank part surrounded by the extracted color (like a donut) using the extracted color.

Setting item	Setting value [Factory default]	Description
Outside trimming	<ul style="list-style-type: none"> • Checked • [Unchecked] 	Places a check <i>Outside trimming</i> , when there is a part not needed to measure in the extracted color inside the measurement region.
Mode	<ul style="list-style-type: none"> • [Cross] • Square 	<p>Specifies the connection conditions for labeling.</p> <ul style="list-style-type: none"> • Cross Processes contiguous parts up, down, left, and right of the target pixel as the same label. • Square Add oblique directions to the <i>Cross</i> processing.
Specify label No.	<ul style="list-style-type: none"> • Checked • [Unchecked] 	Places a check to <i>Specify label No.</i> when targeting only the specified label to extract.

Setting item	Setting value [Factory default]	Description
Sort condition	<ul style="list-style-type: none"> • Area ascending • [Area descending] • X ascending • X descending • Y ascending • Y descending • Elliptic major axis ascending • Elliptic major axis descending • Elliptic minor axis ascending • Elliptic minor axis descending • Elliptic ratio ascending • Elliptic ratio descending • Rectangle width ascending • Rectangle width descending • Rectangle height ascending • Rectangle height descending • Rectangle X ascending • Rectangle X descending • Rectangle Y ascending • Rectangle Y descending • Perimeter ascending • Perimeter descending • Circularity ascending • Circularity descending • Fit rect major axis ascending • Fit rect major axis descending • Fit rect minor axis ascending • Fit rect minor axis descending • Fit rect ratio ascending • Fit rect ratio descending • Inscribed circle X ascending • Inscribed circle X descending • Inscribed circle Y ascending • Inscribed circle Y descending • Inscribed circle R ascending • Inscribed circle R descending • Circum. circle X ascending • Circum. circle X descending • Circum. circle Y ascending • Circum. circle Y descending • Circum. circle R ascending • Circum. circle R descending • Number of holes ascending • Number of holes descending 	<p>Enabled when the <i>Specify label No.</i> is checked.</p> <p>Set the sorting condition to specify a label.</p>
Label No.	0 to 2,499 [0]	<p>Enabled when the <i>Specify label No.</i> is checked.</p> <p>Set the label No. to specify.</p>

Setting item	Setting value [Factory default]	Description
Extraction condition	<ul style="list-style-type: none"> • [None] • Area • X • Y • Elliptic major axis • Elliptic minor axis • Elliptic ratio • Rectangle width • Rectangle height • Rectangle X • Rectangle Y • Perimeter • Circularity • Fit rect major axis • Fit rect minor axis • Inscribed circle R • Circum. circle R • Number of holes 	Sets the conditions to extract a label. <i>Extraction condition</i> can be set up to three.
Extraction condition upper/lower limit	-999,999,999.9999 to 999,999,999.9999 [-999,999,999.9999] to [999,999,999.9999]	Sets the upper and lower limits of the condition to extract a label.
Extraction condition setting	<ul style="list-style-type: none"> • [AND] • OR 	Sets the combining condition for <i>Extraction condition</i> . <ul style="list-style-type: none"> • AND: Labels meeting all extraction conditions set in <i>Extraction condition</i>. • OR: Labels meeting any one of extraction conditions set in <i>Extraction condition</i>.
Output image	<ul style="list-style-type: none"> • [Binary image] • All color image 	Appears when the settings are for a color image. Sets the image to output as the image filtered by the labeling filter.
Measure button	-	Clicking this performs the test measurement and updates the display for <i>Max. / Min.</i> measurement values.
Color Ext button	-	Appears in color image settings. Clicking this switches to <i>Color extract</i> setting screen.
Binary filter button	-	Appears in monochrome image settings. Clicking this switches to <i>Binary</i> setting screen.

● Changing the Custom Linear Filter Settings

Change the settings of the Linear Filter that allows you to set filter coefficients freely. Click **Setting** when setting the filter coefficients.

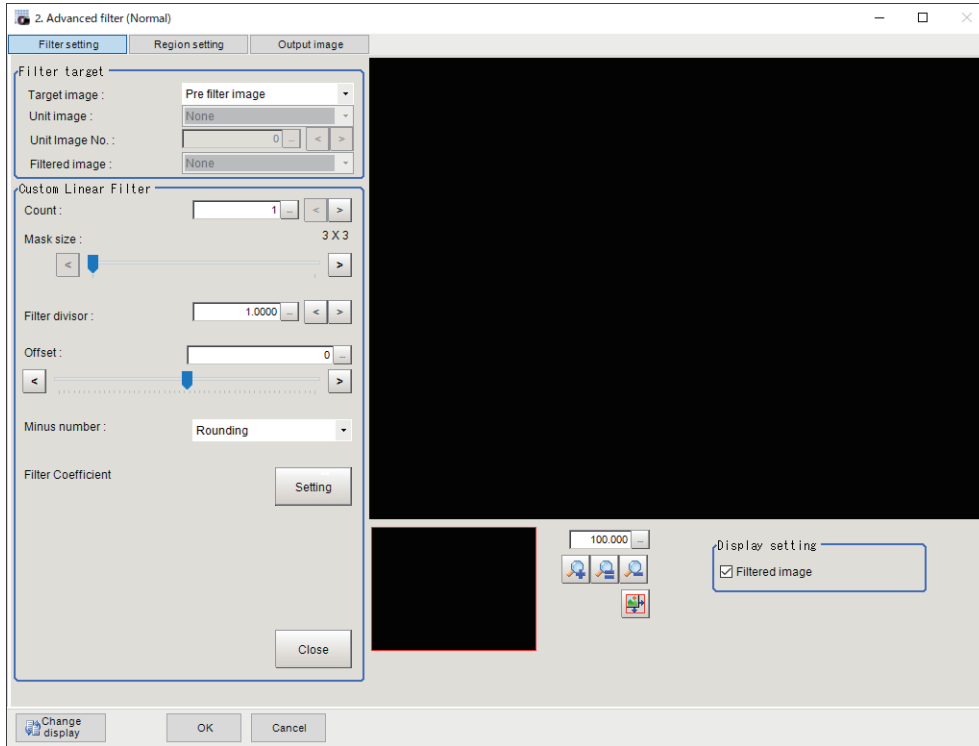

Setting item	Setting value [Factory default]	Description
Count	1 to 9 [1]	Sets the number of times that the filter is applied.
Mask size	3×3 to 21×21 [3×3]	Sets the size of filter mask with an odd numeric value. When the variation in the brightness of peripheral pixels is large, increase the <i>Mask size</i> setting.
Filter divisor	0.0001 to 99,999.9999 [1.0000]	Sets the divisor for pixel values after filter masking. The value resulted from dividing the results of the filter by <i>Filter divisor</i> and adding <i>Offset</i> is the pixel value after filtering. Set this together with the <i>Filter coefficient</i> .
Offset	-255 to 255 [0]	Sets the offset value for the pixel value after filtering. The value resulted from dividing the results of the filter by <i>Filter divisor</i> and adding <i>Offset</i> is the pixel value after filtering.
Minimum number	<ul style="list-style-type: none"> [Rounding] Absolute 	Sets the processing to perform when the pixel value after filtering resulted in a negative value. <ul style="list-style-type: none"> Rounding: Rounds the pixel value to 1. Absolute: Uses the absolute value of the pixel value.
Set all	<ul style="list-style-type: none"> Checked [Unchecked] 	Places a check to <i>Set all</i> when setting all filter values at once.
Filter coefficient	-128 to 127 [0]	Sets the coefficient for the pixel value in filter masking up to the number of filter masking sizes. Set this together with the <i>Filter divisor</i> .
Filtered image	<ul style="list-style-type: none"> [Checked] Unchecked 	Checked: Displays the filtered image.

● Changing the Custom Rank Filter Settings

Change the settings of the Rank Filter that allows you to set filter coefficients freely.

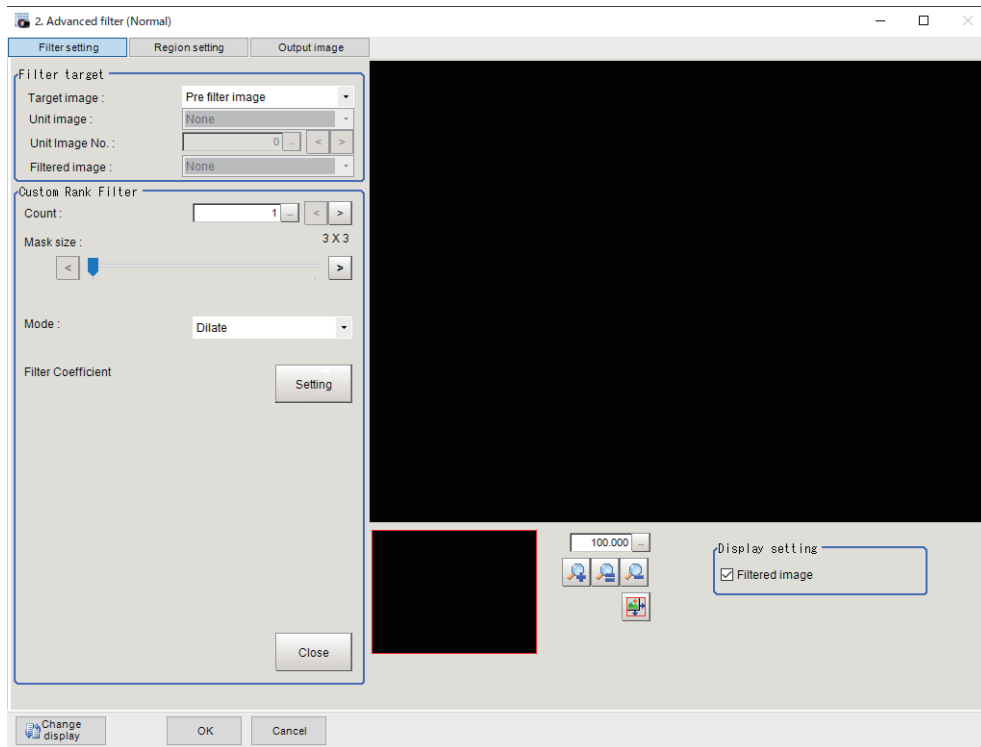

Setting item	Setting value [Factory default]	Description
Count	1 to 9 [1]	Sets the number of times that the filter is applied.
Mask size	3×3 to 21×21 [3×3]	Sets the size of filter mask with an odd numeric value. When the variation in the brightness of peripheral pixels is large, increase the <i>Mask size</i> setting.
Mode	<ul style="list-style-type: none"> [dilate] Erosion 	Sets the filtering method.
Set all	<ul style="list-style-type: none"> Checked [Unchecked] 	When clicking Setting, <i>Filter coefficient</i> dialog is displayed. Places a check to <i>Set all</i> when setting all filter values at once.
Filter coefficient	0 to 1 [1]	Sets the shape to dilate or erode in filter masking. Sets the number of coefficients up to the number of filter masking sizes.
Filtered image	<ul style="list-style-type: none"> [Checked] Unchecked 	Checked: Displays the filtered image.

● Changing the Image Operation Filter Settings

Change the settings of the filter converting each pixel value in one image.

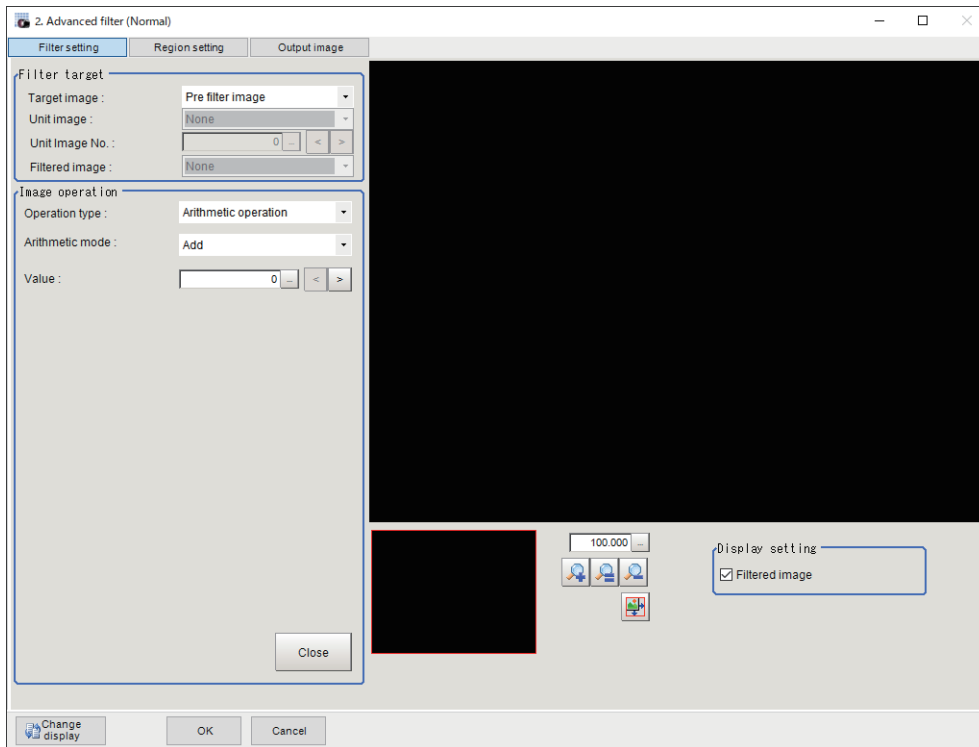

Setting item	Setting value [Factory default]	Description
Operation type	<ul style="list-style-type: none"> • [Arithmetic operation] • bit operation • Bit shift • Change pixel value 	Sets the type of operation used for image operation.
Arithmetic mode	<ul style="list-style-type: none"> • [Add] • Subtraction • Subtraction (absolute) • Multiplication 	Enabled when <i>Arithmetic operation</i> is selected in <i>Operation type</i> . Sets the operation method.
Value	0 to 255 [0]	Enabled when <i>Arithmetic operation</i> is selected in <i>Operation type</i> . Sets the value used to convert the pixel value. The result operated by the operation method specified in the <i>Arithmetic mode</i> will be the converted pixel value.
Bit operation mode	<ul style="list-style-type: none"> • [NOT] • AND • OR • XOR • NAND • NOR • XNOR 	Enabled when <i>Bit operation</i> is selected in <i>Operation type</i> . Sets the operation method for the bit operation.
Value	0 to 255 [0]	Enabled when <i>Bit operation</i> is selected in <i>Operation type</i> . Sets the bit operation value used to convert the pixel value. The result operated by the operation method specified in the <i>Operation mode</i> will be the converted pixel value.

Setting item	Setting value [Factory default]	Description
Bit shift mode	<ul style="list-style-type: none"> [Right bit shift] Left bit shift 	Enabled when <i>Bit shift</i> is selected in the <i>Operation type</i> . Sets the bit shift method. <ul style="list-style-type: none"> Right bit shift: Shifts bits to the right. This makes the pixel values smaller and the image darker. Left bit shift: Shifts bits to the left. This makes the pixel values larger and the image brighter
Shift value	1 to 8 [1]	Enabled when <i>Bit shift</i> is selected in the <i>Operation type</i> . Sets the bit shift value used to convert the pixel values. The result of the pixel value shifted, up to the number of the specified bit shift values, by the bit shift method specified in the <i>Bit shift mode</i> will be the converted pixel value.
Change mode	<ul style="list-style-type: none"> [Change inside bounds] Change outside bounds 	Enabled when <i>Change pixel value</i> is selected in the <i>Operation type</i> . Sets the conversion method for the pixel values. <ul style="list-style-type: none"> Change inside bounds: Converts the pixel values inside the range set in the <i>Change bounds</i> to that of <i>Change value</i>. Change outside bounds: Converts the pixel values outside the range set in the <i>Change bounds</i> to that of <i>Change value</i>.
Change value	1 to 255 [128]	Enabled when <i>Change pixel value</i> is selected in the <i>Operation type</i> . Sets the value used to convert the pixel values. The pixel values for the conversion target specified in the <i>Change mode</i> will be converted to that of <i>Change value</i> .
Change bounds	1 to 255 [1] to [255]	Enabled when <i>Change pixel value</i> is selected in the <i>Operation type</i> . Sets the range of the pixel values to be converted.
Filtered image	<ul style="list-style-type: none"> [Checked] Unchecked 	Checked: Displays the filtered image.

Example: Pixel calculation when arithmetical operations are performed

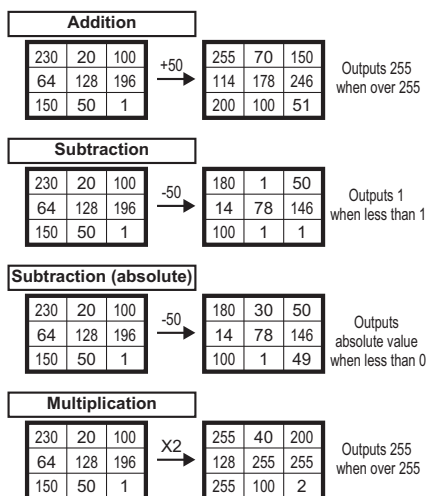

Example: Pixel calculation when bit operations are performed

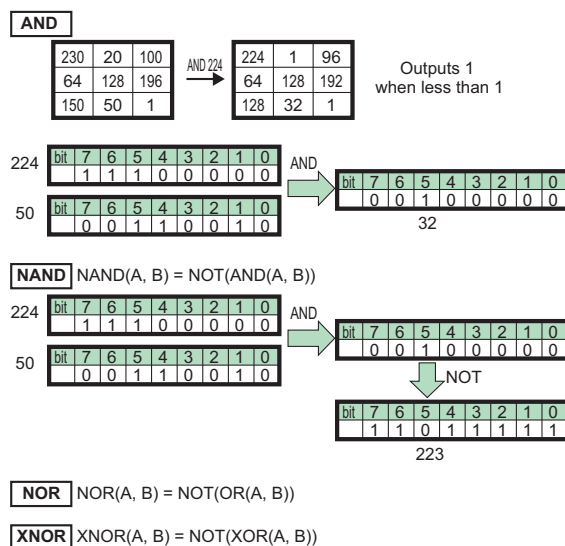

● Changing the 2 Images Operation Settings

Change the settings of a filter to operate paired pixel values of two images.

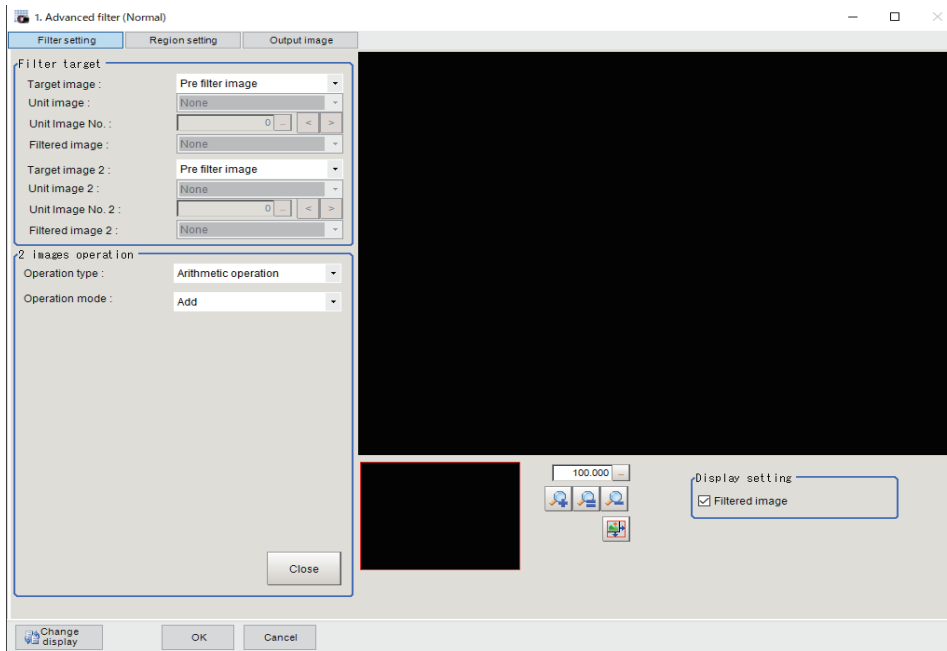

Setting item	Setting value [Factory default]	Description
Operation type	<ul style="list-style-type: none"> • [Arithmetic operation] • Bit operation 	Selects the type of operation for <i>2 Images Operation Filter</i> .
Operation mode	<ul style="list-style-type: none"> • [Add] • Subtraction • Subtraction (Absolute) • Multiplication • Multiplication (Normalization) • Average • Maximum • Minimum 	This option is available when <i>Arithmetic operation</i> is selected in <i>Operation type</i> . Sets the operation method.
Bit operation mode	<ul style="list-style-type: none"> • [AND] • OR • XOR • NAND • NOR • XNOR 	Enabled when <i>Bit operation</i> is selected in <i>Operation type</i> . Sets the operation method for the bit operation.
Filtered image	<ul style="list-style-type: none"> • [Checked] • Unchecked 	Checked: Displays the filtered image.



Additional Information

The Output coordinates (Before/After scroll and Calibration ON/OFF) of the measurement unit for the image after performing 2 images operation are calculated with the image selected in *Target image* of 2 images operation as the reference.

Example:
Image operation in Operation mode

Target image			Target image1		
230	20	100	30	10	50
64	128	196	120	240	60
150	50	1	100	150	200

Add

255	30	150
184	255	255
250	200	201

Subtraction

200	10	50
1	1	136
50	1	1

When exceed 255,
outputs 255.

Subtraction (Absolute)

200	10	50
56	112	136
50	100	199

Multiplication

255	200	255
255	255	255
255	255	200

When less than 1,
outputs 1.

Multiplication (Normalization)

57	1	41
63	255	97
124	62	1

Average

130	15	75
92	184	128
125	100	101

For Multiplication (Normalization),
normalizes the maximum pixel
values of result within the
measurement region to 255.

Maximum

230	20	100
120	240	196
150	150	200

Minimum

30	10	50
64	128	60
100	50	1

Rounds after the decimal
point of result.

Example:
Image operation in Bit operation mode

Target image			Target image1		
230	20	100	255	255	255
64	128	196	1	1	1
150	50	1	255	255	255

AND

230	20	100
1	1	1
150	50	1

OR

255	255	255
65	129	197
255	255	255

XOR

230	20	100
190	126	58
150	50	1

NAND

25	235	155
255	255	255
105	205	254

NOR

1	1	1
190	126	58
1	1	1

XNOR

25	235	155
65	129	197
105	205	254

● Changing the Binary Filter Settings (Monochrome Images Only)

Change the settings of a filter to binarize images.

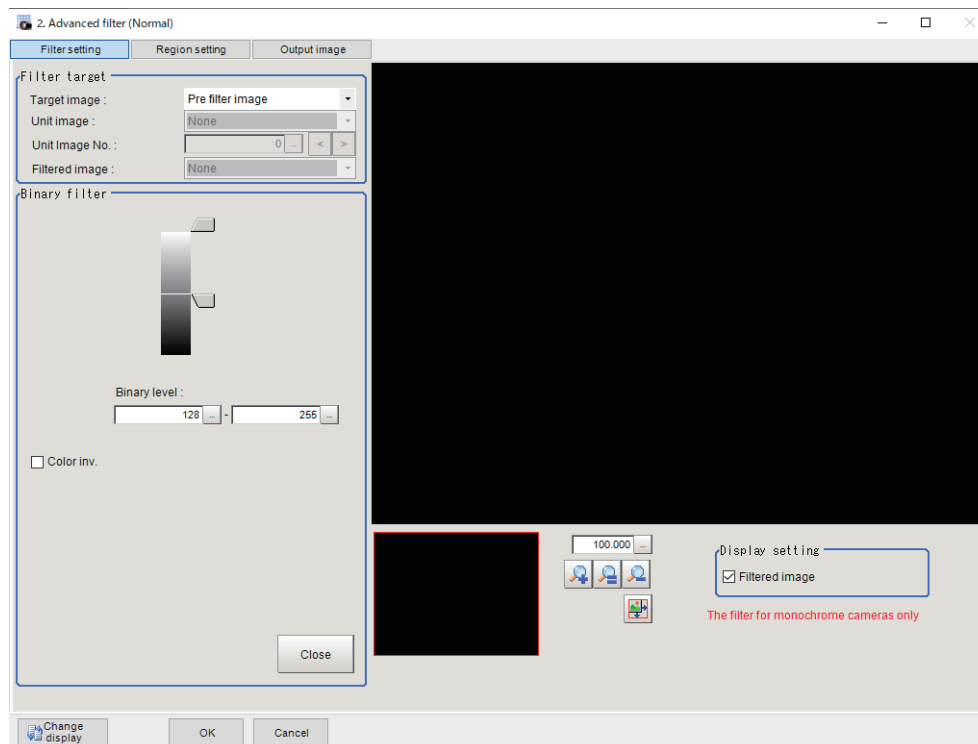

Setting item	Setting value [Factory default]	Description
Binary level	0 to 255 [128] to [255]	Sets a level to convert 256-gradation images to binary images. Set <i>Binary level</i> so that the measurement object becomes white pixels.
Color inv.	<ul style="list-style-type: none"> • Checked • [Unchecked] 	Places a check to <i>Color inv.</i> when reversing white and black.
Filtered image	<ul style="list-style-type: none"> • [Checked] • Unchecked 	Checked: Displays the filtered image.

● **Changing the Color Gray Filter Settings (Color Images Only)**

Change the settings of a filter equivalent to *Color Gray Filter* processing item. (3-5 *Color Gray Filter* on page 3-24)

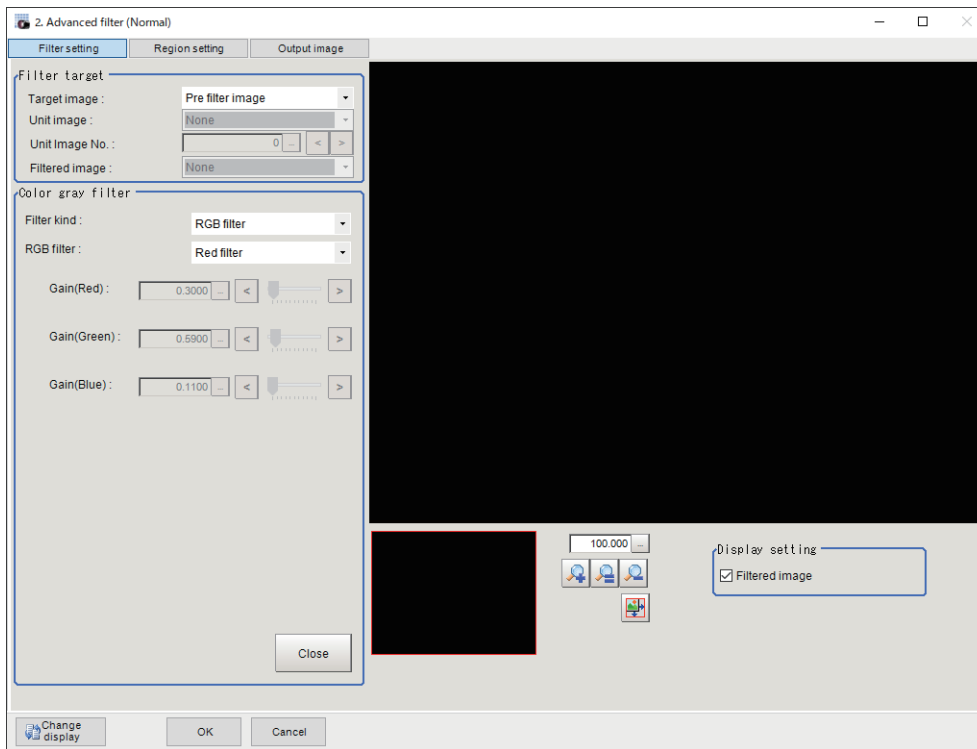

Setting item	Setting value [Factory default]	Description
Filter type	<ul style="list-style-type: none"> • [RGB filter] • HSV filter 	Sets the filter type. <ul style="list-style-type: none"> • RGB filter: Sets the color extraction range with R, G, and B. • HSV filter: Sets the color extraction range with H, S, and V.

Setting item	Setting value [Factory default]	Description
RGB filter	<ul style="list-style-type: none"> • [Red filter] • Green filter • Blue filter • Cyan filter • Magenta filter • Yellow filter • Brightness filter (R+G+B) • Brightness filter (R+2G+B) • Custom filter 	Enabled when <i>RGB filter</i> is selected in <i>Filter type</i> . Sets the type of filter used as the Color Gray filter.
Gain (Red)	0.0001 to 9.9999 [0.3000]	Enabled when <i>Custom filter</i> is selected in <i>RGB filter</i> . Sets the gain of R, G, and B. When there is an RGB component need to emphasize, increase the gain value of the components.
Gain (Green)	0.0001 to 9.9999 [0.5900]	
Gain (Blue)	0.0001 to 9.9999 [0.1100]	
HSV filter	<ul style="list-style-type: none"> • Fast • [Fine] 	Enabled when <i>HSV filter</i> is selected in <i>Filter type</i> . Sets the type of filter used as the Color Gray filter. <ul style="list-style-type: none"> • Fast: Sets the color extraction range only using <i>Standard Hue</i>. • Fine Sets the color extraction range in detail using <i>Standard Hue</i>, <i>Hue range</i>, <i>Color chroma</i>.
Standard Hue	0 to 359 [0]	Enabled when <i>HSV filter</i> is selected in <i>Filter type</i> . Sets the standard hue (tone). Decreases as the difference in hue from the standard hue (difference in tone) increases.
Hue range	10 to 180 [90]	Enabled when <i>Fine</i> is selected in <i>HSV filter</i> . Sets the hue (tone) range. The difference in hue is calculated using a hue range of 255 divisions centered on the <i>Standard Hue</i> . Hues outside the hue range have a density value of 0.
Color chroma	0 to 255 [0] to [255]	Enabled when <i>Fine</i> is selected in <i>HSV filter</i> . Specifies the upper and lower limits for saturation (vividness).
Filtered image	<ul style="list-style-type: none"> • [Checked] • Unchecked 	Checked: Displays the filtered image.

● Changing the Extract Color Filter Settings (Color Images Only)

Change the settings of a filter equivalent to *Extract Color Filter* processing item. (3-6 *Extract Color Filter* on page 3-28)

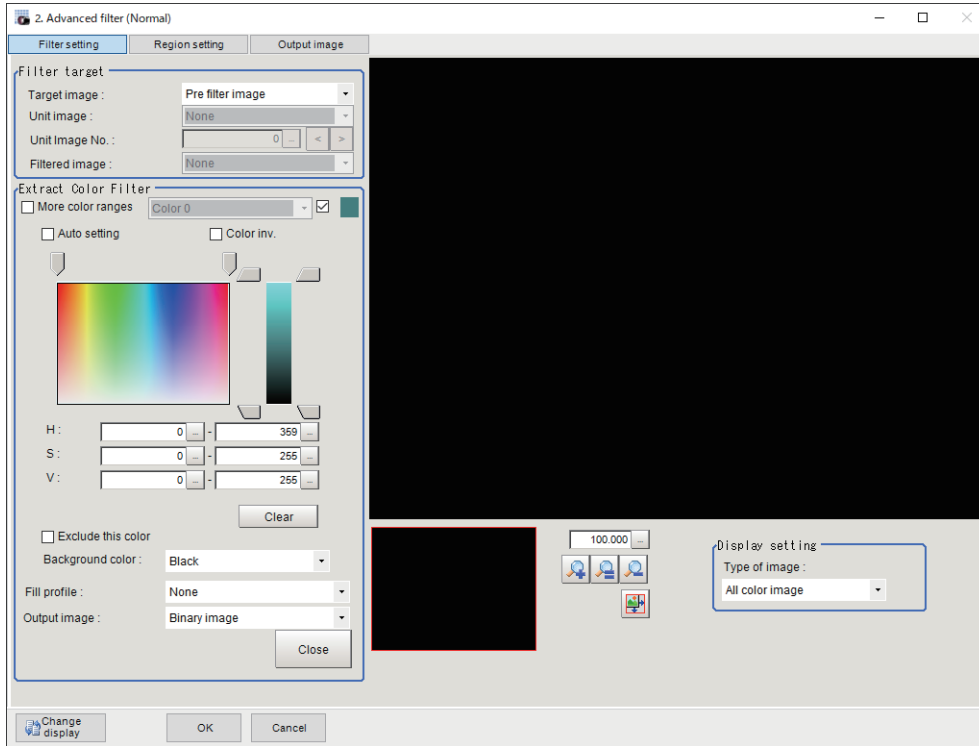

Setting item	Setting value [Factory default]	Description
More color ranges	<ul style="list-style-type: none"> • Checked • [Unchecked] 	Places a check to the <i>More color ranges</i> when extracting multiple colors.
Color extraction range	Color 0 to Color 7 [Color 0]	Enabled when <i>More color ranges</i> are checked. Sets the color ranges to extract.
Select	<ul style="list-style-type: none"> • [Checked] • Unchecked 	Enabled when <i>More color ranges</i> are checked. Places a check to the <i>Select</i> when extracting color using the range selected in the <i>Color extraction range</i> .
Automatic	<ul style="list-style-type: none"> • Checked • [Unchecked] 	Places a check to the <i>Auto setting</i> when setting color specified on an image as the measurement target color.
Color inv.	<ul style="list-style-type: none"> • Checked • [Unchecked] 	Places a check to the <i>Color inv.</i> when measuring color other than the color specified.
H	0 to 359 [0] to [359]	Sets the hue (difference in hue).
S	0 to 255 [0] to [255]	Sets the saturation (difference in saturation).
V	0 to 255 [0] to [255]	Sets the vividness (difference in vividness).
Clear button	-	Restores the color set in the above parameters to the default when clicking this button.
Exclude this color	<ul style="list-style-type: none"> • Checked • [Unchecked] 	Places a check to the <i>Exclude this color</i> when excluding the color range selected in <i>Color extraction range</i> from the extracting target.
Background color	<ul style="list-style-type: none"> • [Black] • White • Red • Green • Blue 	Sets the color used to fill background color parts other than the color to be extracted. When <i>Color selected image</i> is selected in <i>Type of image</i> , the background color can be set for each selected color. When <i>All color image</i> is selected in <i>Type of image</i> , the background color parts are filled with the background color of Color 0.

Setting item	Setting value [Factory default]	Description
Fill profile	<ul style="list-style-type: none"> • [None] • Fill outline • Filling up holes 	<p>Sets the method to fill a central blank part of an image.</p> <ul style="list-style-type: none"> • None The empty section in the center is not filled in. • Fill outline In the measurement region, the part between the extracted-color start point and end point in the X-axis direction is measured as having the extracted color. Since filling is applied only to the X-axis direction, the processing is faster than filling up holes. • Filling up holes The part surrounded by the extracted color, like a doughnut hole, is filled with the extracted color.
Output image	<ul style="list-style-type: none"> • [Binary image] • All color image 	Sets the image that is output after filtering by the Extract Color filter.
Type of image	<ul style="list-style-type: none"> • Measurement image • [All color image] • color selected image • Binary image 	Sets the image to display in the settings screen.

● Changing the Anti-Color Shading Filter Settings (Color Images Only)

Change the settings of a filter equivalent to *Anti-Color Shading Filter* processing item. (3-7 *Anti Color Shading* on page 3-35)

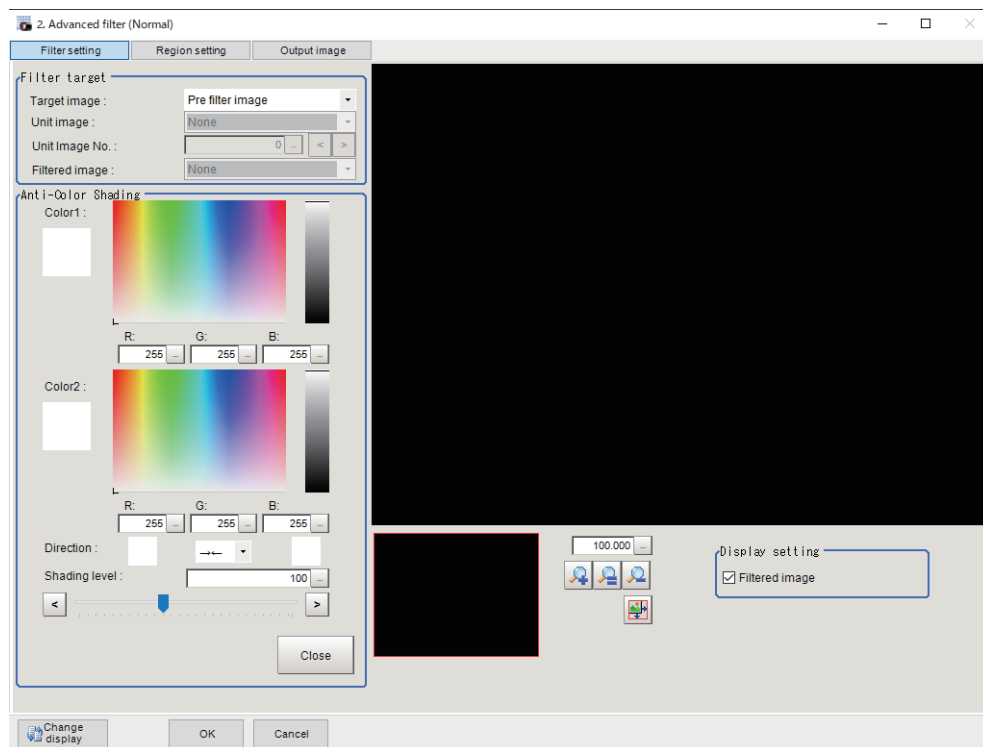

Setting item	Setting value [Factory default]	Description
Color 1RGB	0 to 255 [255]	The most separate two colors are picked up from the specified region.
Color 2RGB	0 to 255 [255]	

Setting item	Setting value [Factory default]	Description
Direction	<ul style="list-style-type: none"> • [→←] • → • ← 	Selects the conversion method from the set <i>Color 1</i> and <i>Color 2</i> . <ul style="list-style-type: none"> • →←: Color 1 and Color 2 are converted to the color midway between the two. • →: Color 1 is converted to Color 2 • ←: Color 2 is converted to Color 1
Shading level	0 to 255 [100]	Sets the level of suppressing color unevenness. The larger this value, the less the color unevenness.
Filtered image	<ul style="list-style-type: none"> • [Checked] • Unchecked 	Unchecks the <i>Filtered image</i> when displaying the original image.

● Changing the Emphasis Defect Filter Settings (Monochrome Images Only)

By dividing a measurement region to small regions (an element), emphasize defects using concentration values in elements.

By regarding defects as a region with concentration differences from the surroundings, emphasize defects by comparing concentration values between surrounding elements and the target element.

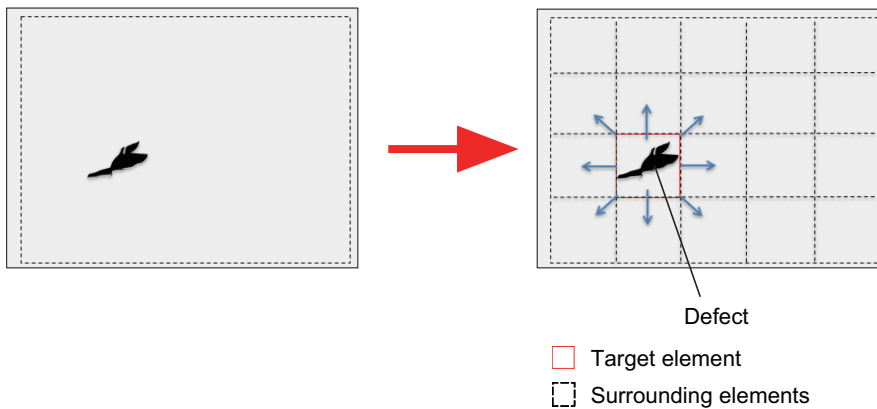

Adjust parameters while checking a size of the defect and concentration differences between the defect and the surroundings.

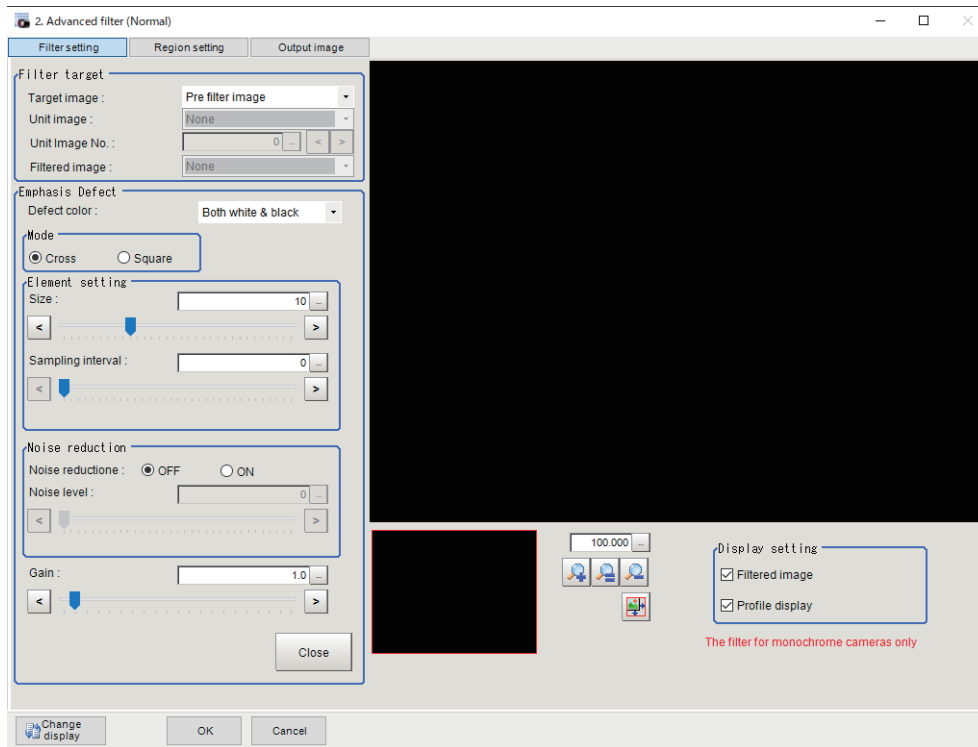

Setting item	Setting value [Factory default]	Description
Detect color	<ul style="list-style-type: none"> White Black [White/Black] 	<ul style="list-style-type: none"> White: Selects this when detecting defects looking brighter than the background. Black: Selects this when detecting defects looking darker than the background. White and Black: Selects this when the brightness of defects are not identified.
Mode	<ul style="list-style-type: none"> [Cross] Square 	<p>Set the position of elements to compare concentration values. When setting this to <i>Square</i>, the defect shape is maintained better than <i>Cross</i>.</p> <ul style="list-style-type: none"> Cross <div data-bbox="801 1451 1038 1688" data-label="Image"> </div> Square <div data-bbox="801 1771 1038 2009" data-label="Image"> </div>

Setting item	Setting value [Factory default]	Description
Size	1 to 32 [10]	With the number of pixels, set the size of elements to compare concentration values. The detection performance is improved when setting the size to fit the minimum defect size.
Sampling interval	0 to 32 [0]	With the number of pixels, set the sampling interval to compare concentration values. Smaller the size, longer the processing time period.
Noise reduction	<ul style="list-style-type: none"> • [OFF] • ON 	Sets whether or not to perform noise reduction. When the detection color is white, it will be considered as noise if surrounding elements having higher concentration values than that of the target element.
Noise removal level	0 to 128 [0]	Sets the level to remove noise. Enabled when <i>Noise reduction</i> is set to <i>ON</i> .
Gain	0.1 to 20.0 [1.0]	Set the image brightness using magnification. Make the dark region in the image easier to see by increasing the value.
Filtered image	<ul style="list-style-type: none"> • [Checked] • Unchecked 	Checked: Displays the filtered image.
Profile display	<ul style="list-style-type: none"> • [Checked] • Unchecked 	Checked: Displays the image profile.



Additional Information

- In the end of a measuring region, the filtering is not executed and an input image is output. When you want to narrow the non-processing area, decrease the **Size** value or the **Sampling interval** value.
- If it is loading an image from a color camera, the input image is not displayed. When filtering an image of a color camera, add the *Color Gray Filter* and then apply this filter to it after converting the image.
- To shorten the processing time, do the following.
 - Reduce the measuring region
 - Increase the **Size** value
 - Increase the **Sampling interval** value

● **Changing the Emphasis Unevenness Filter Settings (Monochrome Images Only)**

Generates an image with the high brightness contrast from an input image and emphasizes unevenness.

The Emphasis Unevenness Filter adds the concentration on the pixels in the mask range while considering the position relationship with the target element. Generate a high gradation image by calculating concentration per mask.

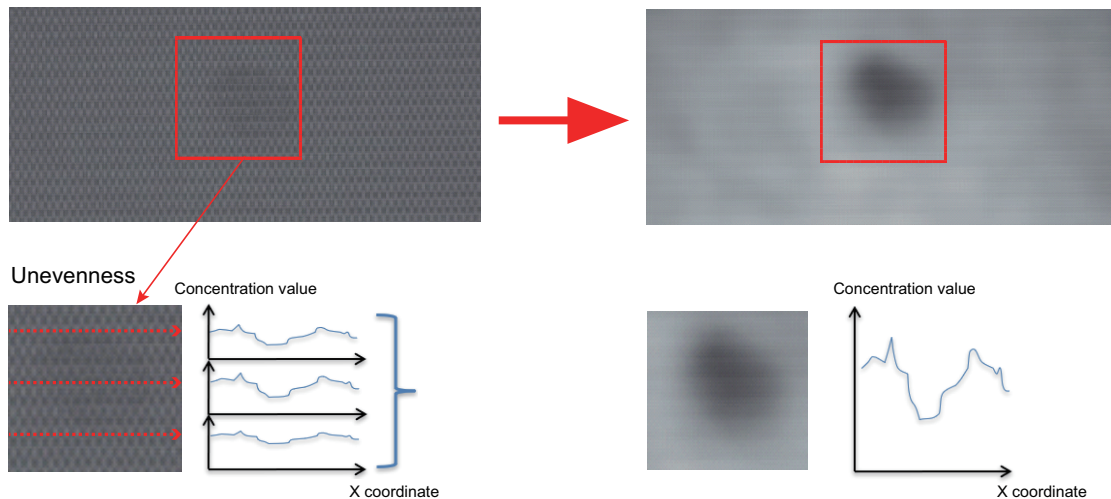

Adjust parameters while checking a size and contrast of unevenness to emphasize.

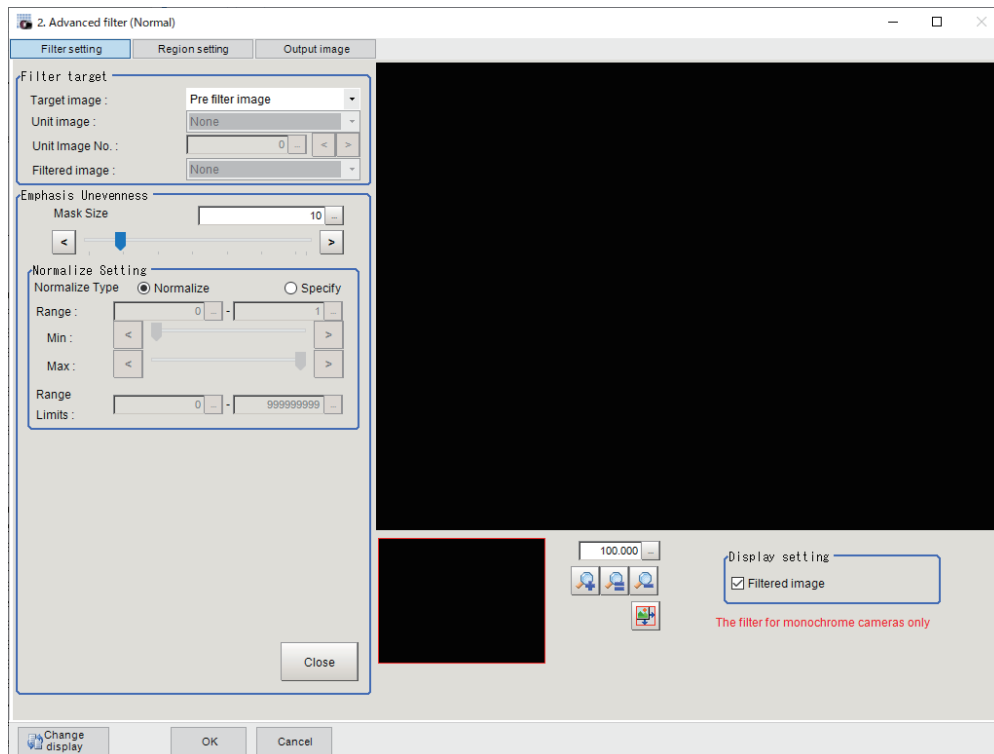

Setting item	Setting value [Factory default]	Description
Mask size	1 to 64 [10]	With the number of pixels, set the size of elements to filter. The detection performance is improved when setting this to a size around double of the target unevenness. Increasing the value blurs edges. Decreasing the value emphasizes edges.

Setting item	Setting value [Factory default]	Description
Normalize type	<ul style="list-style-type: none"> [Normalize] Specify 	Set a range to normalize the overlapped brightness values. Select <i>Specify</i> when a range of specific brightness values needs to convert. <ul style="list-style-type: none"> Normalize: Normalization is performed based on the maximum and minimum values of the overlapped brightness values. Specify: Normalization is performed based on the maximum and minimum values of the Range values.
Range (Min.)	0 to 999,998 Up to the Range (Max.) -1.	Set the range to normalize the overlapped brightness value. When Normalize type is set to <i>Normalize</i> , the maximum and minimum values of the overlapped brightness values are automatically set.
Range (Max.)	1 to 999,999 More than the Range (Min.) +1	
Filtered image	<ul style="list-style-type: none"> [Checked] Unchecked 	Checked: Displays the filtered image.



Additional Information

- In the end of a measuring region, the filtering is not executed and an input image is output. When you want to narrow the non-processing area, decrease the **Mask size** value.
- If it is loading an image from a color camera, the input image is not displayed. When filtering an image of a color camera, add the *Color Gray Filter* and then apply this filter to it after converting the image.
- To shorten the processing time, do the following.
 - Reduce the measuring region
 - Reduce the **Mask size** value

● **Changing the Emphasis Line Defect Filter Settings (Monochrome Images Only)**

Emphasize line defects with low brightness.

Filter an image so that the position relationship of elements with specific concentration differences is linear. Emphasize concentration of the pixels in the mask range linearly.

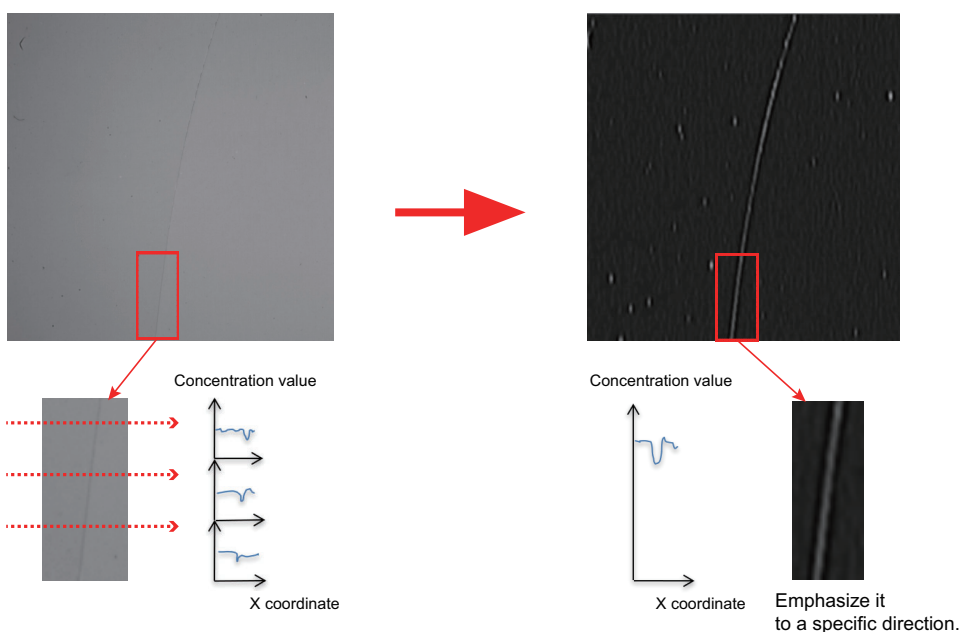

Adjust parameters while checking thickness and width of a line defect to emphasize.

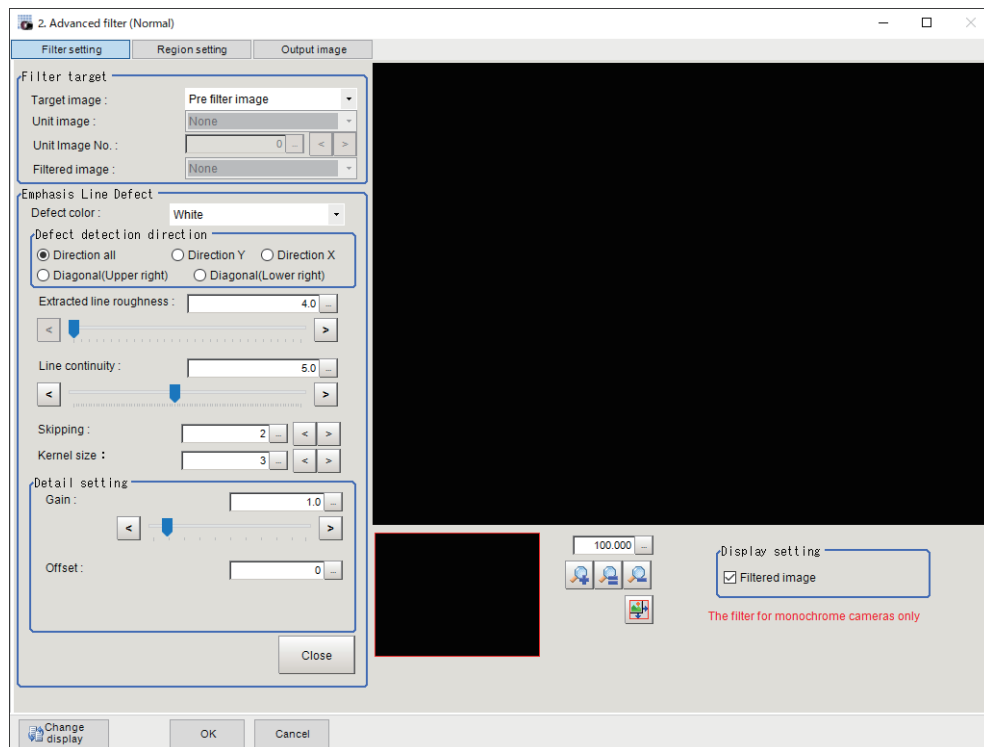

Setting item	Setting value [Factory default]	Description
Detect color	<ul style="list-style-type: none"> Black [White] 	Set the color of a defect to emphasize. <ul style="list-style-type: none"> Black: Selects this when detecting defects looking darker than the background. White: Selects this when detecting defects looking brighter than the background.
Detection	<ul style="list-style-type: none"> Direction all Direction X Direction Y Diagonal (Upper right) Diagonal (Lower right) 	Set the direction of a line defect to emphasize.
Extracted line roughness	4.0 to 10.0 [4.0]	Set the roughness of a line to extract. Increasing the value causes fine features not to be extracted.
Line continuity	1.0 to 10.0 [5.0]	Set this when a broken line needs to be detected. Decreasing the value allow the broken line to be detected easier.
Skipping	0 to 4 [2]	Sets the skipping interval.(0: No skipping) Increasing the value shortens the processing time, but thin lines are deleted.
Kernel size	2 to 5 [3]	With the number of pixels, set the size to filter. Bigger the value, longer the processing time period.
Gain	0.1 to 10.0 [1.0]	Set the image brightness using magnification. Make the dark region in the image easier to see by increasing the value.
Offset	-255 to 255 [0]	Add brightness (concentration value) to an image. Increasing the value lightens an image.

Setting item	Setting value [Factory default]	Description
Filtered image	<ul style="list-style-type: none"> [Checked] Unchecked 	Checked: Displays the filtered image.



Additional Information

- In the end of a measuring region, the filtering is not executed and an input image is output. When you want to narrow the non-processing area, decrease the **Kernel size** value.
- If it is loading an image from a color camera, the input image is not displayed. When filtering an image of a color camera, add the *Color Gray Filter* and then apply this filter to it after converting the image.
- To shorten the processing time, do the following.
 - Reduce the measuring region
 - Increase the **Skipping** value
 - Reduce the **Kernel size** value

● Changing the Emphasis Circle Defect Filter Settings (Monochrome Images Only)

Emphasize circular defects with low brightness.

Filter an image so that the position relationship of pixels with specific concentration values is circular. Emphasize concentration value on the pixels in the mask range circularly.

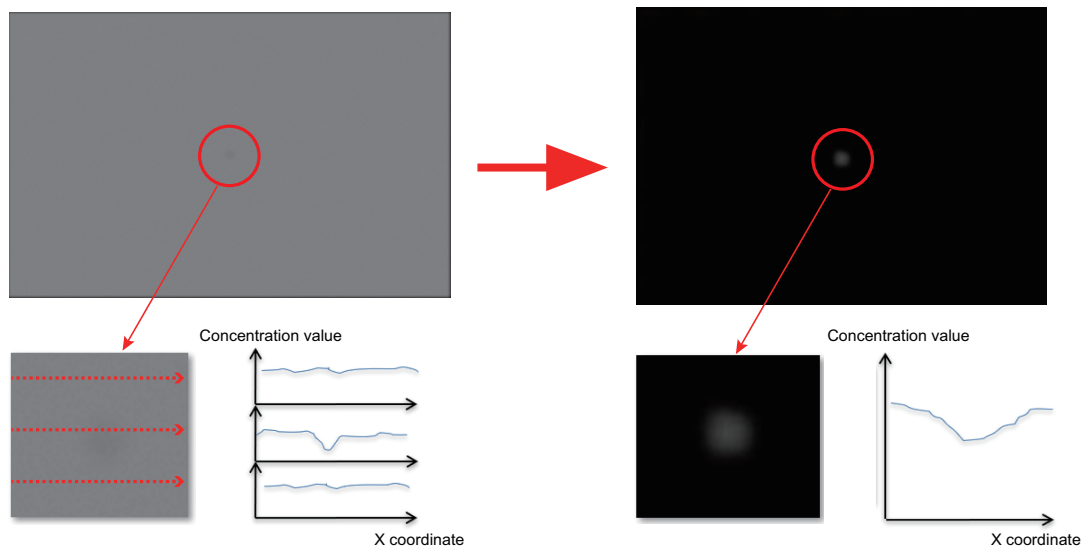

Adjust parameters while checking size and brightness of a circle defect to emphasize.

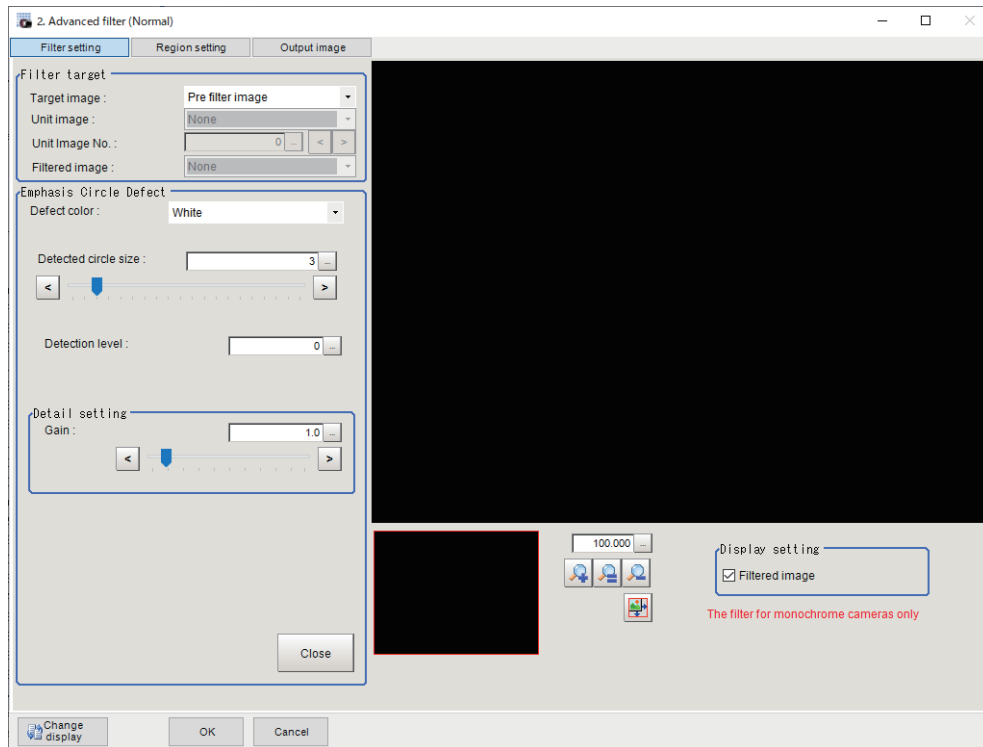

Setting item	Setting value [Factory default]	Description
Detect color	<ul style="list-style-type: none"> • [Black] • White 	Set the color of a defect to emphasize. <ul style="list-style-type: none"> • Black: Selects this when detecting defects looking darker than the background. • White: Selects this when detecting defects looking brighter than the background.
Detected circle size	1 to 20 [3]	Adjust the degree to speed up the processing speed. Increasing the value shortens the processing time, but the circle defect might not remain.
Detection level	0 to 255 [0]	Sets the threshold level to detect. Smaller the value, higher circles with low concentration are detectable.
Gain	0.1 to 10.0 [1.0]	Set the image brightness using magnification. Make the dark region in the image easier to see by increasing the value.
Filtered image	<ul style="list-style-type: none"> • [Checked] • Unchecked 	Checked: Displays the filtered image.



Additional Information

- In the end of a measuring region, the filtering is not executed and an input image is output. When you want to narrow the non-processing area, decrease the **Detected circle size** value.
- If it is loading an image from a color camera, the input image is not displayed. When filtering an image of a color camera, add the *Color Gray Filter* and then apply this filter to it after converting the image.
- To shorten the processing time, do the following.
 - Reduce the measuring region
 - Increase the **Detected circle size** value

3-13-3 Region Settings (Advanced Filter)

It is possible to target the entire screen, but restricting the range can shorten the processing time.

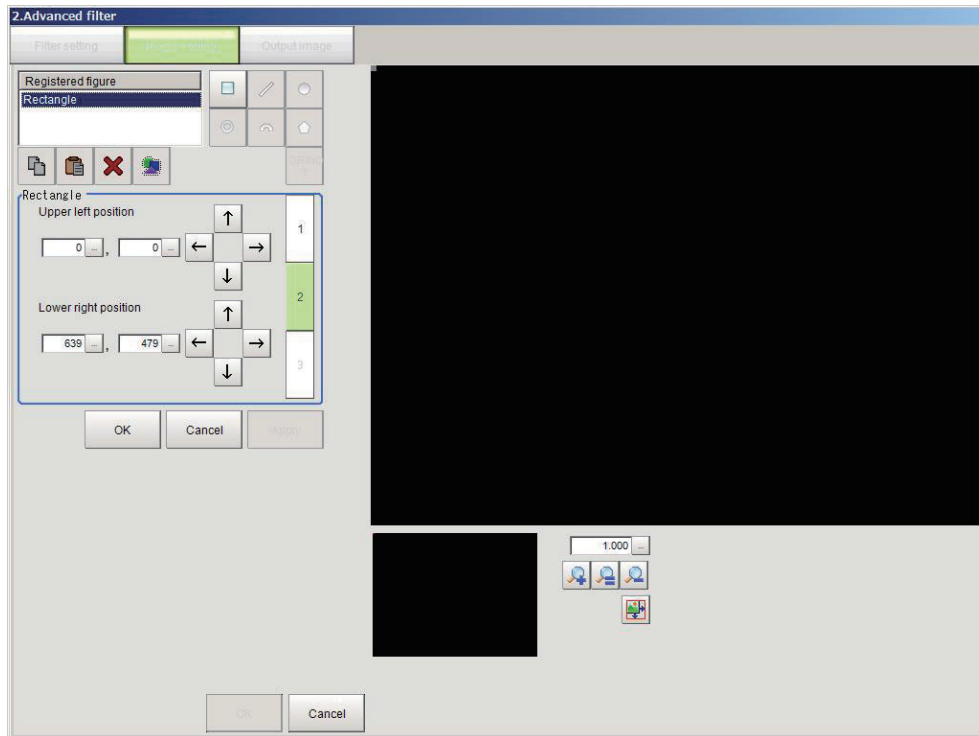

- 1** In the Item tab area, click **Region setting**.
- 2** Click **Edit**.
The *Figure setting* area is displayed.
- 3** Set the area to be filtered.
- 4** Click **OK** in the *Figure setting* area.
 - **OK**: Changes the settings and returns to the previous menu.
 - **Cancel**: Changes are discarded and returns to the previous menu.
 - **Apply**: Updates the settings without leaving the current window.

3-13-4 Output Image Settings (Advanced Filter)

Set this when changing the output image settings.

This item sets images to be output as the measurement processing result. The image set as the output image is available to use as the measurement image on other processing units in the measurement flow.

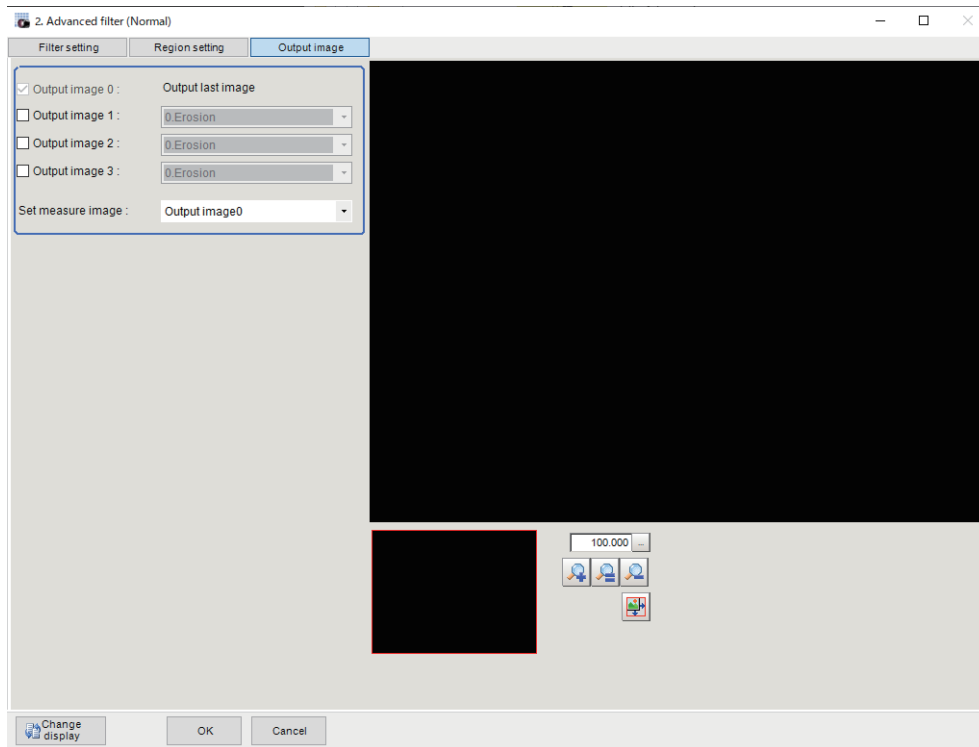

Setting item	Setting value [Factory default]	Description
Output image 0	<ul style="list-style-type: none"> [Checked] Unchecked 	As the final image, sets the image to which all added filters have been applied.
Output image 1	<ul style="list-style-type: none"> Checked 	Places a check this when outputting an image filtered by a specific filter. When <i>Output image</i> is selected, sets the number of the filter to output the image.
Output image 2	<ul style="list-style-type: none"> [Unchecked] 	
Output image 3		
Set measure image	<ul style="list-style-type: none"> [Output image 0] Output image 1 Output image 2 Output image 3 	Sets the image used as the advanced filter image among the output images. The image set in the <i>Set measure image</i> is available to use as the measurement image for measurement in the processing units followed by this unit.

3-13-5 Key Points for Test Measurement and Adjustment (Advanced Filter)

The following content is displayed in the *Detail result* area as text.

Displayed item	Description
Judge	Judgment results 0: No judgment (unmeasured) 1: Judgment result OK -1: Judgment result NG -10: Error (image format mismatch) -11: Error (unregistered model) -12: Error (insufficient memory) -20: Error (other errors)

The image specified in the Sub-image number in the image display setting is displayed in the *Image Display* area.

Sub-image number	Description of image to be displayed
0	Advanced filter image
1	Output image 0
2	Output image 1
3	Output image 2
4	Output image 3
5	Measurement image

Key Points for Adjustment (Advanced Filter)

Adjust the setting parameters referring to the following points.

● When the processing speed is slow

Parameter to be adjusted	Remedy
Region setting	The measurement processing time might take longer because the measurement region is broad. Set the measurement region as narrow as possible.

Notes on Advanced Filter

If Advanced Filter is applied to the image, the area around the image frame will become unstable. When the **Filtering** processing item has been set in the scene, ensure that measurement ranges such as *Region Settings* set by other processing items do not include in the area around the image frame. The width not included in the measurement range varies depending on the mask size settings.

• Mask size: 5×5

Sets two-pixel width around the image frame not to be included in the measurement range.

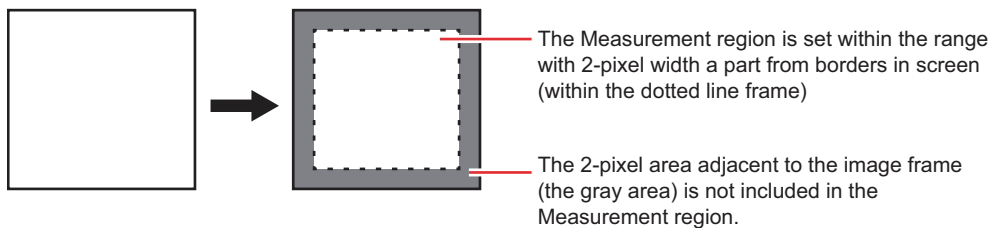

• Mask size: 3×3

Sets one-pixel width around the image frame not to be included in the measurement range.

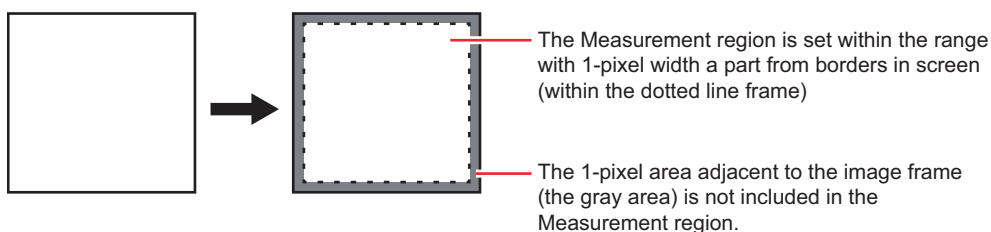

● When a partial scan is used to limit the load range

Set so as not to include the image loading range surroundings.

The width not to be included in the measurement range is the same as the above. (In the following case, the mask size is 5x5.)

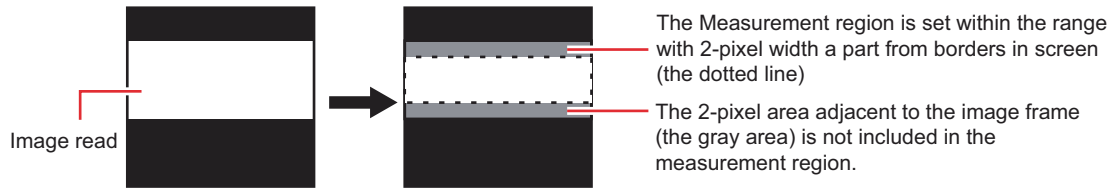

3-13-6 Measurement Results for Which Output Is Possible (Advanced Filter)

There are no measurement results that can be output.

3-13-7 External Reference Tables (Advanced Filter)

No.	Data name	Data ident	Set/Get	Data range
0	Judge	judge	Get only	0: No judgment (unmeasured), 1: Judgment result OK, -1: Judgment result NG, -10: Error (image format mismatch), -11: Error (unregistered model), -12: Error (insufficient memory), -20: Error (other errors)
120	No. of filters	filterNum	Set/Get	0 to 16
121	Set measure image	destImageNo	Set/Get	0 to 3
131	Output image 1	imageOutput1	Set/Get	0: Not output, 1: Output
132	Output image 2	imageOutput2	Set/Get	0: Not output, 1: Output
133	Output image 3	imageOutput3	Set/Get	0: Not output, 1: Output
135	Output image 1 No.	imageOutNo1	Set/Get	0 to 15
136	Output image 2 No.	imageOutNo2	Set/Get	0 to 15
137	Output image 3 No.	imageOutNo3	Set/Get	0 to 15
140	Target image type	targetKind00	Set/Get	0: Measurement image, 1: Pre filter image, 2: Other unit image, 3: Filtered image
:	:	:		
155	Target image type	targetKind15	Set/Get	-1 to 9,999
160	Target Unit	targetUnit00		
:	:	:		
175	Target Unit	targetUnit15	Set/Get	-1 to 15
180	Target Filtering No.	targetNo00		
:	:	:		
195	Target Filtering No.	targetNo15		

No.	Data name	Data ident	Set/Get	Data range
200	Filter type	filterKind00	Set/Get	0: None, 1: Weak smoothing, 2: Strong smoothing, 3: Dilate, 4: Erosion, 5: Median, 6: Extract edges, 7: Extract horizontal edges, 8: Extract vertical edges, 9: Enhance edges, 10: Prewitt, 11: Roberts, 12: Laplacian, 13: Background Suppression, 14: Brightness correct filter, 15: Stripes removal filter II, 16: Labeling filter, 17: Custom linear filter, 18: Custom rank filter, 19: Image operation, 20: 2 images operation, 21: Binary filter, 22: Color gray filter, 23: Extract color filter 24: Anti-color shading, 25: Emphasis defect, 26: Emphasis unevenness, 27: Emphasis line defect, 28: Emphasis circle defect, 29: LoG filter, 30: Guided filter
:	:	:		
215	Filter type	filterKind15		
220	Target Image No.	unitImage00	Set/Get	0 to 9,999
:	:	:		
235	Target Image No.	unitImage15		
280	Filter processing ON/OFF Flag0	filterEnable00	Set/Get	0: OFF, 1: ON
:	:	:		
295	Filter processing ON/OFF Flag15	filterEnable15		
10,200+NN×5,000 (NN=0 to 15)	Filter type: Background Suppression Background Suppression Mode	00_Halation_colorMode to 15_Halation_colorMode	Set/Get	0: RGB common, 1: RGB individual
10,201+NN×5,000 (NN=0 to 15)	Filter type: Background Suppression Lower limit of RGB common	00_Halation_lowCommon to 15_Halation_lowCommon	Set/Get	0 to 255
10,202+NN×5,000 (NN=0 to 15)	Filter type: Background Suppression Upper limit of RGB common	00_Halation_uppCommon to 15_Halation_uppCommon	Set/Get	0 to 255
10,203+NN×5,000 (NN=0 to 15)	Filter type: Background Suppression Lower limit R of RGB individual	00_Halation_lowRed to 15_Halation_lowRed	Set/Get	0 to 255
10,204+NN×5,000 (NN=0 to 15)	Filter type: Background Suppression Upper limit R of RGB individual	00_Halation_uppRed to 15_Halation_uppRed	Set/Get	0 to 255

No.	Data name	Data ident	Set/Get	Data range
10,205+NN×5,000 (NN=0 to 15)	Filter type: Background Suppression Lower limit G of RGB individual	00_Halation_lowGreen to 15_Halation_lowGreen	Set/Get	0 to 255
10,206+NN×5,000 (NN=0 to 15)	Filter type: Background Suppression Upper limit G of RGB individual	00_Halation_uppGreen to 15_Halation_uppGreen	Set/Get	0 to 255
10,207+NN×5,000 (NN=0 to 15)	Filter type: Background Suppression Lower limit B of RGB individual	00_Halation_lowBlue to 15_Halation_lowBlue	Set/Get	0 to 255
10,208+NN×5,000 (NN=0 to 15)	Filter type: Background Suppression Upper limit B of RGB individual	00_Halation_uppBlue to 15_Halation_uppBlue	Set/Get	0 to 255
10,209+NN×5,000 (NN=0 to 15)	Filter type: Background Suppression Lower limit of Gray	00_Halation_lowGray to 15_Halation_lowGray	Set/Get	0 to 255
10,210+NN×5,000 (NN=0 to 15)	Filter type: Background Suppression Upper limit of Gray	00_Halation_uppGray to 15_Halation_uppGray	Set/Get	0 to 255
10,211+NN×5,000 (NN=0 to 15)	Filter type: Background Suppression Filtered image	00_Halation_halationImage to 15_Halation_halationImage	Set/Get	0: Original image, 1: Filtered image
10,300+NN×5,000 (NN=0 to 15)	Filter type: Brightness correct filter Uneven removal	00_Shading_un-evenRemove to 15_Shading_un-evenRemove	Set/Get	0: OFF, 1: ON
10,301+NN×5,000 (NN=0 to 15)	Filter type: Brightness correct filter Filter direction	00_Shading_direction to 15_Shading_direction	Set/Get	0: H&V, 1: Horizontal, 2: Vertical
10,302+NN×5,000 (NN=0 to 15)	Filter size(Odd)	00_Shading_filter-Size to 15_Shading_filterSize	Set/Get	3 to 255
10,303+NN×5,000 (NN=0 to 15)	Gain	00_Shading_gain to 15_Shading_gain	Set/Get	1 to 63
10,304+NN×5,000 (NN=0 to 15)	Offset	00_Shading_offset to 15_Shading_offset	Set/Get	0 to 255
10,305+NN×5,000 (NN=0 to 15)	Filtered image	00_Shading_shadingImage to 15_Shading_shadingImage	Set/Get	0: Original image, 1: Filtered image
10,400+NN×5,000 (NN=0 to 15)	Method	00_Rank2_correct-Method to 15_Rank2_correct-Method	Set/Get	0: Thick stripe off (morphology difference), 1: Pinstripe off (morphology)

No.	Data name	Data ident	Set/Get	Data range
10,401+NN×5,000 (NN=0 to 15)	Filter direction	00_Rank2_direction to 15_Rank2_direction	Set/Get	0: H&V, 1: Horizontal, 2: Vertical, 3: Diagonal (upper right), 4: Diagonal (lower right)
10,402+NN×5,000 (NN=0 to 15)	Filter size(Odd)	00_Rank2_filterSize to 15_Rank2_filterSize	Set/Get	3 to 63
10,403+NN×5,000 (NN=0 to 15)	Brightness	00_Rank2_defect-Bright to 15_Rank2_defect-Bright	Set/Get	0: Light and Dark, 1: Light, 2: Dark
10,404+NN×5,000 (NN=0 to 15)	Gain	00_Rank2_gain to 15_Rank2_gain	Set/Get	1 to 63
10,405+NN×5,000 (NN=0 to 15)	Offset	00_Rank2_offset to 15_Rank2_offset	Set/Get	0 to 255
10,406+NN×5,000 (NN=0 to 15)	Filtered image	00_Rank2_rank2Image to 15_Rank2_rank2Image	Set/Get	0: Original image, 1: Filtered image
10,500+NN×5,000 (NN=0 to 15)	Color inv.	00_Labeling_invert to 15_Labeling_invert	Set/Get	0: OFF, 1: ON
10,501+NN×5,000 (NN=0 to 15)	Upper limit of the binary level	00_Labeling_upperLevel to 15_Labeling_upperLevel	Set/Get	0 to 255
10,502+NN×5,000 (NN=0 to 15)	Lower limit of the binary level	00_Labeling_lowerLevel to 15_Labeling_lowerLevel	Set/Get	0 to 255
10,503+NN×5,000 (NN=0 to 15)	Outside trimming	00_Labeling_cutOut to 15_Labeling_cutOut	Set/Get	0: OFF, 1: ON
10,504+NN×5,000 (NN=0 to 15)	Filling up holes	00_Labeling_holePlug to 15_Labeling_holePlug	Set/Get	0: OFF, 1: ON
10,505+NN×5,000 (NN=0 to 15)	Specify label No.	00_Labeling_labelSelect to 15_Labeling_labelSelect	Set/Get	0: All, 1: Specify No.
10,506+NN×5,000 (NN=0 to 15)	Label No.	00_Labeling_labelNo to 15_Labeling_labelNo	Set/Get	0 to 2,499
10,507+NN×5,000 (NN=0 to 15)	Extraction condition	00_Labeling_extOperant to 15_Labeling_extOperant	Set/Get	0: AND, 1: OR
10,509+NN×5,000 (NN=0 to 15)	Sort condition	00_Labeling_sortMode to 15_Labeling_sortMode	Set/Get	0 to 43
10,510+NN×5,000 (NN=0 to 15)	Output image	00_Labeling_outputImage to 15_Labeling_outputImage	Set/Get	0: Binary image, 1: Extract image

No.	Data name	Data ident	Set/Get	Data range
10,511+NN×5,000 (NN=0 to 15)	Multiple selections	00_Labeling_multiSelect to 15_Labeling_multiSelect	Set/Get	0: Multiselect NG, 1: MultiSelect OK
10,512+NN×5,000 (NN=0 to 15)	ImageKind	00_Labeling_imageKind to 15_Labeling_imageKind	Set/Get	0: Measurement image, 1: All color image, 2: Selection color image, 3: Binary image
10,520+NN×5,000+N (NN=0 to 15, N=0 to 7)	Color	00_Labeling_flag0 to 15_Labeling_flag7	Set/Get	0: Not used, 1: Used
10,530+NN×5,000+N (NN=0 to 15, N=0 to 7)	Flag for OR/NOT	00_Labeling_orNo0 to 1500_Labeling_orNo7	Set/Get	0: OR, 1: NOT
10,540+NN×5,000+N (NN=0 to 15, N=0 to 7)	Min. color difference	00_Labeling_lowH0 to 15_Labeling_lowH7	Set/Get	0 to 359
10,550+NN×5,000+N (NN=0 to 15, N=0 to 7)	Max. color difference	00_Labeling_uppH0 to 15_Labeling_uppH7	Set/Get	0 to 359
10,560+NN×5,000+N (NN=0 to 15, N=0 to 7)	Min. saturation	00_Labeling_lowS0 to 15_Labeling_lowS7	Set/Get	0 to 255
10,570+NN×5,000+N (NN=0 to 15, N=0 to 7)	Max. saturation	00_Labeling_uppS0 to 15_Labeling_uppS7	Set/Get	0 to 255
10,580+NN×5,000+N (NN=0 to 15, N=0 to 7)	Min. brightness	00_Labeling_lowV0 to 15_Labeling_lowV7	Set/Get	0 to 255
10,590+NN×5,000+N (NN=0 to 15, N=0 to 7)	Max. brightness	00_Labeling_uppV0 to 15_Labeling_uppV7	Set/Get	0 to 255
10,600+NN×5,000 (NN=0 to 15)	No. of extraction conditions	00_Labeling_extNum to 15_Labeling_extNum	Set/Get	1 to 8
10,610+NN×5,000+N (NN=0 to 15, N=0 to 7)	Judgement condition	00_Labeling_extKind0 to 15_Labeling_extKind7	Set/Get	0 to 17
10,630+NN×5,000+N (NN=0 to 15, N=0 to 7)	Lower limit for judge condition	00_Labeling_extMin0 to 15_Labeling_extMin7	Set/Get	-999,999,999.9999 to 999,999,999.9999

No.	Data name	Data ident	Set/Get	Data range
10,650+NN×5,00 0+N (NN=0 to 15, N=0 to 7)	Upper limit for judge condition	00_Labeling_ext- tMax0 to 15_Label- ing_extMax7	Set/Get	-999,999,999.9999 to 999,999,999.9999
10,660+NN×5,00 0+N (NN=0 to 15, N=0 to 7)	Background color	00_Labeling_back- ground0 to 15_La- beling_background7	Set/Get	0: Black, 1: White, 2: Red, 3: Green, 4: Blue
10,668+NN×5,00 0 (NN=0 to 15)	Filtered image	00_Labeling_label- ingImage to 15_La- beling_labelingImage	Set/Get	0: Original image, 1: Filtered image
10,675+NN×5,00 0 (NN=0 to 15)	Mode	00_Labeling_neigh- borhoodMode to 15_Labeling_neigh- borhoodMode	Set/Get	0: 4-neighbor, 1: 8-neighbor
10,700+NN×5,00 0 (NN=0 to 15)	Count	00_Custom- Line_count to 15_Custom- Line_count	Set/Get	1 to 9
10,701+NN×5,00 0 (NN=0 to 15)	Mask Size	00_Custom- Line_maskSize to 15_Custom- Line_maskSize	Set/Get	0: 3x3, 1: 5x5 2: 7x7, 3: 9x9, 4: 11x11, 5: 13x13, 6: 15x15, 7: 17x17, 8: 19x19, 9: 21x21
10,702+NN×5,00 0 (NN=0 to 15)	Filter divisor	00_CustomLine_div to 15_Custom- Line_div	Set/Get	0.0001 to 99,999.9999
10,703+NN×5,00 0 (NN=0 to 15)	Offset	00_CustomLine_off- set to 15_Custom- Line_offset	Set/Get	-255 to 255
10,704+NN×5,00 0 (NN=0 to 15)	Minus number	00_CustomLine_kind to 15_Custom- Line_kind	Set/Get	0: Rounding, 1: Absolute
10,710+NN×5,00 0+N (NN=0 to 15, N=0 to 440)	Filter Coefficient	00_CustomLine_co- ef000 to 15_Custom- Line_coef440	Set/Get	-128 to 127
11,151+NN×5,00 0 (NN=0 to 15)	Filtered image	00_CustomLine_cus- tomLineImage to 15_CustomLine_cus- tomLineImage	Set/Get	0: Original image, 1: Filtered image
11,200+NN×5,00 0 (NN=0 to 15)	Count	00_Custom- Rank_count to 15_Custom- Rank_count	Set/Get	1 to 9
11,201+NN×5,00 0 (NN=0 to 15)	Mask Size	00_Custom- Rank_maskSize to 15_Custom- Rank_maskSize	Set/Get	0: 3x3, 1: 5x5, 2: 7x7, 3: 9x9, 4: 11x11, 5: 13x13, 6: 15x15, 7: 17x17, 8: 19x19, 9: 21x21
11,202+NN×5,00 0 (NN=0 to 15)	Mode	00_Custom- Rank_kind to 15_Custom- Rank_kind	Set/Get	0: Dilate, 1: Erosion

No.	Data name	Data ident	Set/Get	Data range
11,210+NN×5,000+N (NN=0 to 15, N=0 to 440)	Filter Coefficient	00_CustomRank_coef000 to 15_CustomRank_coef440	Set/Get	0 to 1
11,651+NN×5,000 (NN=0 to 15)	Filtered image	00_CustomRank_customRank-Image to 15_CustomRank_customRankImage	Set/Get	0: Original image, 1: Filtered image
11,700+NN×5,000 (NN=0 to 15)	Operation type	00_Calc_kind to 15_Calc_kind	Set/Get	0:Arithmetic operation, 1:Bit operation, 2:Bit shift, 3:Change pixel value
11,701+NN×5,000 (NN=0 to 15)	Arithmetic mode	00_Calc_calcMode to 15_Calc_calcMode	Set/Get	0: Add, 1:Subtraction, 2:Subtraction (Absolute), 3: Multiplication
11,702+NN×5,000 (NN=0 to 15)	Arithmetic	00_Calc_calcValue to 15_Calc_calcValue	Set/Get	0 to 255
11,703+NN×5,000 (NN=0 to 15)	Operation mode	00_Calc_bitMode to 15_Calc_bitMode	Set/Get	0: NOT, 1: AND, 2: OR, 3: XOR, 4: NAND, 5: NOR, 6: XNOR
11,704+NN×5,000 (NN=0 to 15)	Value	00_Calc_bitValue to 15_Calc_bitValue	Set/Get	0 to 255
11,705+NN×5,000 (NN=0 to 15)	Bit shift mode	00_Calc_shiftMode to 15_Calc_shiftMode	Set/Get	0: Right Bit shift, 1: Left Bit shift
11,706+NN×5,000 (NN=0 to 15)	Shift value	00_Calc_shiftValue to 15_Calc_shiftValue	Set/Get	1 to 8
11,707+NN×5,000 (NN=0 to 15)	Change mode	00_Calc_transMode to 15_Calc_transMode	Set/Get	0: Change inside bounds, 1: Change outside bounds
11,708+NN×5,000 (NN=0 to 15)	Change value	00_Calc_transValue to 15_Calc_transValue	Set/Get	1 to 255
11,709+NN×5,000 (NN=0 to 15)	Lower limit of Change bounds	00_Calc_transLow to 15_Calc_transLow	Set/Get	1 to 255
11,710+NN×5,000 (NN=0 to 15)	Upper limit of Change bounds	00_Calc_transUpp to 15_Calc_transUpp	Set/Get	1 to 255
11,711+NN×5,000 (NN=0 to 15)	Filtered image	00_Calc_calcImage to 15_Calc_calcImage	Set/Get	0: Original image, 1: Filtered image
11,800+NN×5,000 (NN=0 to 15)	Operation type	00_Multimg_kind to 15_Multimg_kind	Set/Get	0: Arithmetic operation, 1: Bit operation
11,801+NN×5,000 (NN=0 to 15)	Target Image type	00_Multimg_targetKind2 to 15_Multimg_targetKind2	Set/Get	0: Measure image, 1: Pre filter image, 2: Other unit image, 3: Filtered image

No.	Data name	Data ident	Set/Get	Data range
11,802+NN×5,000 (NN=0 to 15)	Unit	00_Multilmg_targetUnit2 to 15_Multilmg_targetUnit2	Set/Get	-1 to 9,999
11,803+NN×5,000 (NN=0 to 15)	Target No.	00_Multilmg_targetNo2 to 15_Multilmg_targetNo2	Set/Get	-1 to 15
11,804+NN×5,000 (NN=0 to 15)	Operation mode	00_Multilmg_calcMode to 15_Multilmg_calcMode	Set/Get	0: Add, 1: Subtraction, 2: Subtraction (Absolute), 3: Multiplication, 4: Multiplication (Normalization), 5: Average, 6: Maximum, 7: Minimum
11,805+NN×5,000 (NN=0 to 15)	bitOperation mode	00_Multilmg_bitMode to 15_Multilmg_bitMode	Set/Get	0: AND, 1: OR, 2: XOR, 3: NAND, 4: NOR, 5: XNOR
11,806+NN×5,000 (NN=0 to 15)	Unit Image No.	00_Multilmg_unitImage2 to 15_Multilmg_unitImage2	Set/Get	0 to 9,999
11,807+NN×5,000 (NN=0 to 15)	Filtered image	00_Multilmg_multilmgImage to 15_Multilmg_multilmgImage	Set/Get	0: Original image, 1: Filtered image
11,900+NN×5,000 (NN=0 to 15)	Color inv.	00_Binary_invert to 15_Binary_invert	Set/Get	0: OFF, 1: ON
11,901+NN×5,000 (NN=0 to 15)	Upper limit of the binary level	00_Binary_upper to 15_Binary_upper	Set/Get	0 to 255
11,902+NN×5,000 (NN=0 to 15)	Lower limit of the binary level	00_Binary_lower to 15_Binary_lower	Set/Get	0 to 255
11,903+NN×5,000 (NN=0 to 15)	Filtered image	00_Binary_binaryImage to 15_Binary_binaryImage	Set/Get	0: Original image, 1: Filtered image
12,000+NN×5,000 (NN=0 to 15)	Sub-Filter type	00_ColorGray_kind to 15_ColorGray_kind	Set/Get	0: RGB filter, 1: HSV filter
12,001+NN×5,000 (NN=0 to 15)	Sub-RGB filter	00_ColorGray_kindColor to 15_ColorGray_kindColor	Set/Get	0: Red filter, 1: Green filter, 2: Blue filter, 3: Cyan filter, 4: Magenta filter, 5: Yellow filter, 6: Brightness filter (R+G+B), 7: Brightness filter (R+2G+B), 8: Custom filter
12,002+NN×5,000 (NN=0 to 15)	Sub-Gain(Red)	00_ColorGray_gain to 15_ColorGray_gain	Set/Get	0.0001 to 9.9999
12,003+NN×5,000 (NN=0 to 15)	Sub-Gain(Green)	00_ColorGray_gain1 to 15_ColorGray_gain1	Set/Get	0.0001 to 9.9999
12,004+NN×5,000 (NN=0 to 15)	Sub-Gain(Blue)	00_ColorGray_gain2 to 15_ColorGray_gain2	Set/Get	0.0001 to 9.9999

No.	Data name	Data ident	Set/Get	Data range
12,005+NN×5,000 (NN=0 to 15)	Sub-HSV filter	00_ColorGray_kind-ColorGray to 15_ColorGray_kindColor-Gray	Set/Get	0:Fast, 1:Fine
12,006+NN×5,000 (NN=0 to 15)	Sub-Standard Hue	00_Color-Gray_standardH to 15_Color-Gray_standardH	Set/Get	0 to 359
12,007+NN×5,000 (NN=0 to 15)	Sub-Hue range	00_Color-Gray_hueRange to 15_Color-Gray_hueRange	Set/Get	10 to 180
12,008+NN×5,000 (NN=0 to 15)	Sub-Upper Limit for Saturation	00_ColorGray_upperS to 15_Color-Gray_upperS	Set/Get	0 to 255
12,009+NN×5,000 (NN=0 to 15)	Sub-Lower Limit for Saturation	00_ColorGray_lowerS to 15_Color-Gray_lowerS	Set/Get	0 to 255
12,010+NN×5,000 (NN=0 to 15)	Filtered image	00_ColorGray_color-GrayImage to 15_ColorGray_color-GrayImage	Set/Get	0: Original image, 1: Filtered image
12,100+NN×5,000 (NN=0 to 15)	Fill profile	00_ColorExt_fill to 15_ColorExt_fill	Set/Get	0: OFF, 1: Fill profile, 2: Filling up holes
12,101+NN×5,000 (NN=0 to 15)	Inverse presence	00_ColorExt_invert to 15_ColorExt_invert	Set/Get	0: OFF, 1: ON
12,102+NN×5,000 (NN=0 to 15)	Image type	00_ColorExt_image-Kind to 15_Color-Ext_imageKind	Set/Get	0 to 3
12,103+NN×5,000 (NN=0 to 15)	Multiple selections	00_ColorExt_multi-Select to 15_Color-Ext_multiSelect	Set/Get	0: Multiselect NG, 1: MultiSelect OK
12,104+NN×5,000 (NN=0 to 15)	Output image	00_ColorExt_output-Image to 15_Color-Ext_outputImage	Set/Get	0: Binary image, 1: All color image
12,110+NN×5,000+N (NN=0 to 15, N=0 to 7)	Usage flag	00_ColorExt_flag0 to 15_ColorExt_flag7	Set/Get	0: Not used, 1: Used
12,118+NN×5,000+N (NN=0 to 15, N=0 to 7)	Flag for OR/NOT	00_ColorExt_orNo0 to 15_ColorExt_or-No7	Set/Get	0: OR, 1: NOT
12,126+NN×5,000+N (NN=0 to 15, N=0 to 7)	Min. color difference	00_ColorExt_lowH0 to 15_Color-Ext_lowH7	Set/Get	0 to 359

No.	Data name	Data ident	Set/Get	Data range
12,134+NN×5,00 0+N (NN=0 to 15, N=0 to 7)	Max. color difference	00_ColorExt_uppH0 to 15_Color- Ext_uppH7	Set/Get	0 to 359
12,142+NN×5,00 0+N (NN=0 to 15, N=0 to 7)	Min. saturation	00_ColorExt_lowS0 to 15_Color- Ext_lowS7	Set/Get	0 to 255
12,150+NN×5,00 0+N (NN=0 to 15, N=0 to 7)	Max. saturation	00_ColorExt_uppS0 to 15_Color- Ext_uppS7	Set/Get	0 to 255
12,158+NN×5,00 0+N (NN=0 to 15, N=0 to 7)	Min. brightness	00_ColorExt_lowV0 to 15_Color- Ext_lowV7	Set/Get	0 to 255
12,166+NN×5,00 0+N (NN=0 to 15, N=0 to 7)	Max. brightness	00_ColorExt_uppV0 to 15_Color- Ext_uppV7	Set/Get	0 to 255
12,174+NN×5,00 0+N (NN=0 to 15, N=0 to 7)	Background color	00_ColorExt_back- ground0 to 15_Color- Ext_background7	Set/Get	0: Black, 1: White, 2: Red, 3: Green, 4: Blue
12,200+NN×5,00 0 (NN=0 to 15)	Colour 1R	00_Even_colorR1 to 15_Even_colorR1	Set/Get	0 to 255
12,201+NN×5,00 0 (NN=0 to 15)	Colour 1G	00_Even_colorG1 to 15_Even_colorG1	Set/Get	0 to 255
12,202+NN×5,00 0 (NN=0 to 15)	Colour 1B	00_Even_colorB1 to 15_Even_colorB1	Set/Get	0 to 255
12,203+NN×5,00 0 (NN=0 to 15)	Colour 2R	00_Even_colorR2 to 15_Even_colorR2	Set/Get	0 to 255
12,204+NN×5,00 0 (NN=0 to 15)	Colour 2G	00_Even_colorG2 to 15_Even_colorG2	Set/Get	0 to 255
12,205+NN×5,00 0 (NN=0 to 15)	Colour 2B	00_Even_colorB2 to 15_Even_colorB2	Set/Get	0 to 255
12,206+NN×5,00 0 (NN=0 to 15)	Reference color 1R	00_Even_col- or1_temp0 to 15_Even_col- or1_temp0	Set/Get	0 to 255
12,207+NN×5,00 0 (NN=0 to 15)	Reference color 1G	00_Even_col- or1_temp1 to 15_Even_col- or1_temp1	Set/Get	0 to 255

No.	Data name	Data ident	Set/Get	Data range
12,208+NN×5,000 (NN=0 to 15)	Reference color 1B	00_Even_color1_temp2 to 15_Even_color1_temp2	Set/Get	0 to 255
12,209+NN×5,000 (NN=0 to 15)	Reference color 2R	00_Even_color2_temp0 to 15_Even_color2_temp0	Set/Get	0 to 255
12,210+NN×5,000 (NN=0 to 15)	Reference color 2G	00_Even_color2_temp1 to 15_Even_color2_temp1	Set/Get	0 to 255
12,211+NN×5,000 (NN=0 to 15)	Reference color 2B	00_Even_color2_temp2 to 15_Even_color2_temp2	Set/Get	0 to 255
12,212+NN×5,000 (NN=0 to 15)	Shading level	00_Even_evenLevel to 15_Even_evenLevel	Set/Get	0 to 255
12,213+NN×5,000 (NN=0 to 15)	Direction	00_Even_mode to 15_Even_mode	Set/Get	0: →←, 1: →, 2: ←
12,214+NN×5,000 (NN=0 to 15)	Filtered image	00_Even_evenImage to 15_Even_evenImage	Set/Get	0 to 1
12,400+NN×5,000 (NN=0 to 15)	Defect color	00_Defect_filterType to 15_Defect_filterType	Set/Get	1: White, 2: Black, 3: Black and White
12,401+NN×5,000 (NN=0 to 15)	Mode	00_Defect_mode to 15_Defect_mode	Set/Get	0: Cross, 1: Square
12,403+NN×5,000 (NN=0 to 15)	Size	00_Defect_maskRadius to 15_Defect_maskRadius	Set/Get	1 to 32
12,404+NN×5,000 (NN=0 to 15)	Sampling interval	00_Defect_maskSpace to 15_Defect_maskSpace	Set/Get	0 to 32
12,405+NN×5,000 (NN=0 to 15)	Noise reduction	00_Defect_noise to 15_Defect_noise	Set/Get	0: OFF, 1: ON
12,406+NN×5,000 (NN=0 to 15)	Noise level	00_Defect_noiseLevel to 15_Defect_noiseLevel	Set/Get	0 to 128
12,407+NN×5,000 (NN=0 to 15)	Gain	00_Defect_gain_double to 15_Defect_gain_double	Set/Get	0.1 to 20
12,408+NN×5,000 (NN=0 to 15)	Filtered image	00_Defect_highContrastImage to 15_Defect_highContrastImage	Set/Get	0: Image prior to transfer, 1: Image after transfer

No.	Data name	Data ident	Set/Get	Data range
12,409+NN×5,000 (NN=0 to 15)	MouseX	00_Defect_mouseX to 15_Defect_mouseX	Set/Get	0 to 99,999
12,410+NN×5,000 (NN=0 to 15)	MouseY	00_Defect_mouseY to 15_Defect_mouseY	Set/Get	0 to 99,999
12,411+NN×5,000 (NN=0 to 15)	Profile display	00_Defect_profile to 15_Defect_profile	Set/Get	0: OFF, 1: ON
12,500+NN×5,000 (NN=0 to 15)	Mask Size	00_EvenEmpha_maskSize to 15_EvenEmpha_maskSize	Set/Get	1 to 64
12,501+NN×5,000 (NN=0 to 15)	Normalize Method	00_EvenEmpha_nor to 15_EvenEmpha_nor	Set/Get	0: Normalization, 1: Specified Value
12,507+NN×5,000 (NN=0 to 15)	Range Min	00_EvenEmpha_lower to 15_EvenEmpha_lower	Set/Get	0 to 999,999,998
12,508+NN×5,000 (NN=0 to 15)	Range Max	00_EvenEmpha_upper to 15_EvenEmpha_upper	Set/Get	1 to 999,999,999
12,509+NN×5,000 (NN=0 to 15)	Filtered image	00_EvenEmpha_image to 15_EvenEmpha_image	Set/Get	0: Original image, 1: Filtered image
12,600+NN×5,000 (NN=0 to 15)	Defect color	00_LineDetector_filterType to 15_LineDetector_filterType	Set/Get	0: Black only, 1: White only
12,601+NN×5,000 (NN=0 to 15)	Direction	00_LineDetector_direction to 15_LineDetector_direction	Set/Get	0: Derection all, 1: DirectionY, 2: DirectionX, 3: Diagonal (Upper right), 4: Diagonal (Lower right)
12,605+NN×5,000 (NN=0 to 15)	Graininess level	00_LineDetector_extractionLevel to 15_LineDetector_extractionLevel	Set/Get	4.0 to 10.0
12,606+NN×5,000 (NN=0 to 15)	Line size	00_LineDetector_lineSize to 15_LineDetector_lineSize	Set/Get	1 to 10
12,607+NN×5,000 (NN=0 to 15)	Skipping	00_LineDetector_thinningNum to 15_LineDetector_thinningNum	Set/Get	0 to 4
12,608+NN×5,000 (NN=0 to 15)	Gain	00_LineDetector_gain to 15_LineDetector_gain	Set/Get	0.1 to 10.0
12,609+NN×5,000 (NN=0 to 15)	Offset	00_LineDetector_offset to 15_LineDetector_offset	Set/Get	-255 to 255

No.	Data name	Data ident	Set/Get	Data range
12,610+NN×5,000 (NN=0 to 15)	Filtered image	00_LineDetector_image to 15_LineDetector_image	Set/Get	0: Original image, 1: Filtered image
12,611+NN×5,000 (NN=0 to 15)	Kernel size	00_LineDetector_filterKernelSize to 15_LineDetector_filterKernelSize	Set/Get	2 to 5
12,700+NN×5,000 (NN=0 to 15)	Defect color	00_CircleDetector_filterType to 15_CircleDetector_filterType	Set/Get	0: Black only, 1: White only
12,701+NN×5,000 (NN=0 to 15)	Skipping	00_CircleDetector_thinningNum to 15_CircleDetector_thinningNum	Set/Get	1 to 20
12,702+NN×5,000 (NN=0 to 15)	Gain	00_CircleDetector_gain to 15_CircleDetector_gain	Set/Get	0.1 to 10.0
12,703+NN×5,000 (NN=0 to 15)	Detection level	00_CircleDetector_offset to 15_CircleDetector_offset	Set/Get	0 to 255
12,704+NN×5,000 (NN=0 to 15)	Filtered image	00_CircleDetector_image to 15_CircleDetector_image	Set/Get	0: Original image, 1: Filtered image
12,800+NN×5,000 (NN=0 to 15)	Count	00_Log_count to 15_Log_count	Set/Get	1 to 9
12,801+NN×5,000 (NN=0 to 15)	Filter size	00_Log_filterSize to 15_Log_filterSize	Set/Get	1 to 9
12,803+NN×5,000 (NN=0 to 15)	Gain	00_Log_gain to 15_Log_gain	Set/Get	0.1 to 20.0
12,804+NN×5,000 (NN=0 to 15)	Offset	00_Log_offset to 15_Log_offset	Set/Get	-255 to 255
12,805+NN×5,000 (NN=0 to 15)	Filtered image	00_Log_image to 15_Log_image	Set/Get	0: Original image, 1: Filtered image
12,900+NN×5,000 (NN=0 to 15)	Count	00_Guided_count to 15_Guided_count	Set/Get	1 to 9
12,901+NN×5,000 (NN=0 to 15)	Filter size	00_Guided_filterSize to 15_Guided_filterSize	Set/Get	0 to 14
12,902+NN×5,000 (NN=0 to 15)	Filter strength	00_Guided_filterStrength to 15_Guided_filterStrength	Set/Get	1 to 100
12,903+NN×5,000 (NN=0 to 15)	Skipping	00_Guided_thinningNum to 15_Guided_thinningNum	Set/Get	0 to 2

No.	Data name	Data ident	Set/Get	Data range
12,906+NN×5,000 (NN=0 to 15)	Filtered image	00_Guided_image to 15_Guided_image	Set/Get	0: Original image, 1: Filtered image
13,000+NN×5,000 (NN=0 to 15)	Mask Size	00_Week-Smooth_maskSize to 15_Week-Smooth_maskSize	Set/Get	0: 3x3, 1: 5x5
13,001+NN×5,000 (NN=0 to 15)	Count	00_Week-Smooth_count to 15_Week-Smooth_count	Set/Get	1 to 9
13,002+NN×5,000 (NN=0 to 15)	Filtered image	00_Week-Smooth_week-smoothImage to 15_Week-Smooth_week-smoothImage	Set/Get	0: Original image, 1: Filtered image
13,100+NN×5,000 (NN=0 to 15)	Mask Size	00_Strong-Smooth_maskSize to 15_Strong-Smooth_maskSize	Set/Get	0: 3x3, 1: 5x5
13,101+NN×5,000 (NN=0 to 15)	Count	00_Strong-Smooth_count to 15_Strong-Smooth_count	Set/Get	1 to 9
13,102+NN×5,000 (NN=0 to 15)	Filtered image	00_Strong-Smooth_image to 15_Strong-Smooth_image	Set/Get	0: Original image, 1: Filtered image
13,200+NN×5,000 (NN=0 to 15)	Mask Size	00_Dilate_maskSize to 15_Dilate_mask-Size	Set/Get	0: 3x3, 1: 5x5
13,201+NN×5,000 (NN=0 to 15)	Count	00_Dilate_count to 15_Dilate_count	Set/Get	1 to 9
13,202+NN×5,000 (NN=0 to 15)	Filtered image	00_Dilate_dilate-Image to 15_Di-late_dilateImage	Set/Get	0: Original image, 1: Filtered image
13,300+NN×5,000 (NN=0 to 15)	Mask Size	00_Erosion_mask-Size to 15_Ero-sion_maskSize	Set/Get	0: 3x3, 1: 5x5
13,301+NN×5,000 (NN=0 to 15)	Count	00_Erosion_count to 15_Erosion_count	Set/Get	1 to 9
13,302+NN×5,000 (NN=0 to 15)	Filtered image	00_Erosion_erosion-Image to 15_Ero-sion_erosionImage	Set/Get	0: Original image, 1: Filtered image
13,400+NN×5,000 (NN=0 to 15)	Mask Size	00_Median_mask-Size to 15_Me-dian_maskSize	Set/Get	0: 3x3, 1: 5x5

No.	Data name	Data ident	Set/Get	Data range
13,401+NN×5,000 (NN=0 to 15)	Count	00_Median_count to 15_Median_count	Set/Get	1 to 9
13,402+NN×5,000 (NN=0 to 15)	Filtered image	00_Median_medianImage to 15_Median_medianImage	Set/Get	0: Original image, 1: Filtered image
13,500+NN×5,000 (NN=0 to 15)	Mask Size	00_ExtractEdges_maskSize to 15_ExtractEdges_maskSize	Set/Get	0: 3x3, 1: 5x5
13,501+NN×5,000 (NN=0 to 15)	Count	00_ExtractEdges_count to 15_ExtractEdges_count	Set/Get	1 to 9
13,502+NN×5,000 (NN=0 to 15)	Filtered image	00_ExtractEdges_image to 15_ExtractEdges_image	Set/Get	0: Original image, 1: Filtered image
13,600+NN×5,000 (NN=0 to 15)	Mask Size	00_ExtractHorizontalEdges_maskSize to 15_ExtractHorizontalEdges_maskSize	Set/Get	0: 3x3, 1: 5x5
13,601+NN×5,000 (NN=0 to 15)	Count	00_ExtractHorizontalEdges_count to 15_ExtractHorizontalEdges_count	Set/Get	1 to 9
13,602+NN×5,000 (NN=0 to 15)	Filtered image	00_ExtractHorizontalEdges_image to 15_ExtractHorizontalEdges_image	Set/Get	0: Original image, 1: Filtered image
13,700+NN×5,000 (NN=0 to 15)	Mask Size	00_ExtractVerticalEdges_maskS to 15_ExtractVerticalEdges_maskS	Set/Get	0: 3x3, 1: 5x5
13,701+NN×5,000 (NN=0 to 15)	Count	00_ExtractVerticalEdges_count to 15_ExtractVerticalEdges_count	Set/Get	1 to 9
13,702+NN×5,000 (NN=0 to 15)	Filtered image	00_ExtractVerticalEdges_image to 15_ExtractVerticalEdges_image	Set/Get	0: Original image, 1: Filtered image
13,800+NN×5,000 (NN=0 to 15)	Mask Size	00_EdgeEmphasis_maskSize to 15_EdgeEmphasis_maskSize	Set/Get	0: 3x3, 1: 5x5
13,801+NN×5,000 (NN=0 to 15)	Count	00_EdgeEmphasis_count to 15_EdgeEmphasis_count	Set/Get	1 to 9
13,802+NN×5,000 (NN=0 to 15)	Filtered image	00_EdgeEmphasis_image to 15_EdgeEmphasis_image	Set/Get	0: Original image, 1: Filtered image

No.	Data name	Data ident	Set/Get	Data range
13,900+NN×5,000 (NN=0 to 15)	Count	00_Prewitt_count to 15_Prewitt_count	Set/Get	1 to 9
13,901+NN×5,000 (NN=0 to 15)	Filtered image	00_Prewitt_prewitt-Image to 15_Prewitt_prewittImage	Set/Get	0: Original image, 1: Filtered image
14,000+NN×5,000 (NN=0 to 15)	Count	00_Roberts_count to 15_Roberts_count	Set/Get	1 to 9
14,001+NN×5,000 (NN=0 to 15)	Filtered image	00_Roberts_roberts-Image to 15_Roberts_robertsImage	Set/Get	0: Original image, 1: Filtered image
14,100+NN×5,000 (NN=0 to 15)	Count	00_Laplacian_count to 15_Laplacian_count	Set/Get	1 to 9
14,101+NN×5,000 (NN=0 to 15)	Filtered image	00_Laplacian_laplacianImage to 15_Laplacian_laplacianImage	Set/Get	0: Original image, 1: Filtered image
90,000	figure0 Count	figArea0_count	Set/Get	1
90,001	figure0 Type	figArea0_fig0_type	Set/Get	8: Rectangle
90,002	figure0 mode	figArea0_fig0_mode	Set/Get	0: OR
90,014	figure0 Rectangle Upper left position X	figArea0_fig0_box_X0	Set/Get	-99,999 to 99,999
90,015	figure0 Rectangle Upper left position Y	figArea0_fig0_box_Y0	Set/Get	-99,999 to 99,999
90,016	figure0 Rectangle Lower right position X	figArea0_fig0_box_X1	Set/Get	-99,999 to 99,999
90,017	figure0 Rectangle Lower right position Y	figArea0_fig0_box_Y1	Set/Get	-99,999 to 99,999
90,099	figure0 Update	figArea0_update	Set only	1: Update

3-14 Panorama

This processing item cannot be used in the FHV series.

Images captured from multiple cameras are combined into one image.

This processing item focuses on the features of images at combining and combines the images by compensating the image positions and angles. This processing item focuses on the features of images at combining, and combines the images after compensating the image positions and angles. Therefore, users can get high-accurate combined images without strictly designing camera installation positions.

This processing item does not support an intelligent Compact Digital Camera, FZ-SQ□□□□.

This processing item supports only the same type of camera images.

Used in the Following Case

When combining multiple camera input images

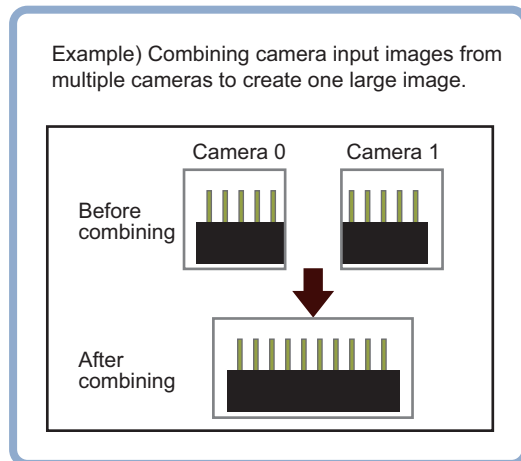

Precautions for Correct Use

- In the same image measurement, the first processing time after the controller started can be longer compared to the second and later processing time.
- Use the image conversion logging processing item to save the images after panorama conversion.
- In the measurement flow, if the processing unit that generates the calibration data is set after the processing unit that corrects the image, the output coordinates that can be acquired by the processing unit after the processing unit that generates the calibration data are only the coordinates after image correction.

Camera Arrangement

For camera arrangement, there are two selectable methods.

Item	Description															
2×2	<p>The arrangement combines images using two images in vertical and two images in horizontal. One pattern.</p> <table border="1" data-bbox="552 517 850 730"> <tr> <td data-bbox="552 517 679 600">Camera allotment number 0</td> <td data-bbox="679 517 722 600"></td> <td data-bbox="722 517 850 600">Camera allotment number 1</td> </tr> <tr> <td data-bbox="552 600 679 645"></td> <td data-bbox="679 600 722 645"></td> <td data-bbox="722 600 850 645"></td> </tr> <tr> <td data-bbox="552 645 679 730">Camera allotment number 2</td> <td data-bbox="679 645 722 730"></td> <td data-bbox="722 645 850 730">Camera allotment number 3</td> </tr> </table>	Camera allotment number 0		Camera allotment number 1				Camera allotment number 2		Camera allotment number 3						
Camera allotment number 0		Camera allotment number 1														
Camera allotment number 2		Camera allotment number 3														
1×4	<p>The arrangement combines images arranged horizontally. There are three patterns: two, three, and 4 images used.</p> <table border="1" data-bbox="552 824 850 954"> <tr> <td data-bbox="552 824 679 954">Camera allotment number 0</td> <td data-bbox="679 824 722 954"></td> <td data-bbox="722 824 850 954">Camera allotment number 1</td> </tr> </table> <table border="1" data-bbox="552 987 1023 1117"> <tr> <td data-bbox="552 987 679 1117">Camera allotment number 0</td> <td data-bbox="679 987 722 1117"></td> <td data-bbox="722 987 850 1117">Camera allotment number 1</td> <td data-bbox="850 987 893 1117"></td> <td data-bbox="893 987 1023 1117">Camera allotment number 2</td> </tr> </table> <table border="1" data-bbox="552 1151 1192 1270"> <tr> <td data-bbox="552 1151 679 1270">Camera allotment number 0</td> <td data-bbox="679 1151 722 1270"></td> <td data-bbox="722 1151 850 1270">Camera allotment number 1</td> <td data-bbox="850 1151 893 1270"></td> <td data-bbox="893 1151 1023 1270">Camera allotment number 2</td> <td data-bbox="1023 1151 1066 1270"></td> <td data-bbox="1066 1151 1192 1270">Camera allotment number 3</td> </tr> </table>	Camera allotment number 0		Camera allotment number 1	Camera allotment number 0		Camera allotment number 1		Camera allotment number 2	Camera allotment number 0		Camera allotment number 1		Camera allotment number 2		Camera allotment number 3
Camera allotment number 0		Camera allotment number 1														
Camera allotment number 0		Camera allotment number 1		Camera allotment number 2												
Camera allotment number 0		Camera allotment number 1		Camera allotment number 2		Camera allotment number 3										

Camera Installation and Image Combination Method

● Camera arrangement (2 × 2 or 2 lines)

1 Set the camera arrangement.

Determine how the cameras should be placed so that the fields of view of adjacent cameras, whose camera numbers are each assigned to a camera assigned number, overlap each other vertically and horizontally by 1/4 or more.

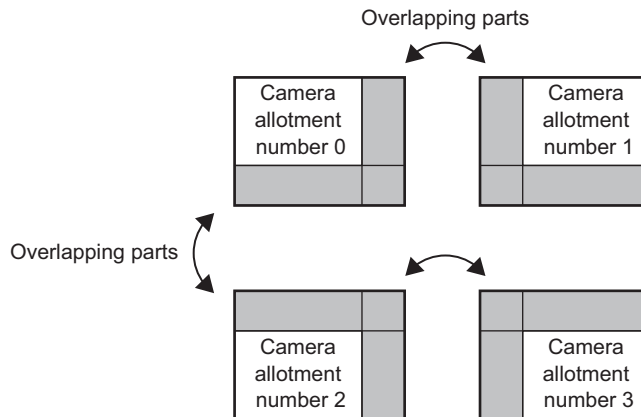

- 2 Adjust the image positions.
Use the Offset X and Y buttons on the setting screen to align the overlapping parts of the adjacent images that are being combined.

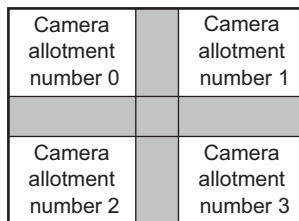

- 3 Combine the images.
Click **Combine** on the setting screen.

● Camera arrangement (1 x 4 or one line)

- 1 Set the camera arrangement
As an example, describe using combining four images.
Determine how the cameras should be placed so that the fields of vision of adjacent cameras, whose camera numbers are each assigned to a camera assigned number, overlap each other vertically and horizontally by 1/4 or more.

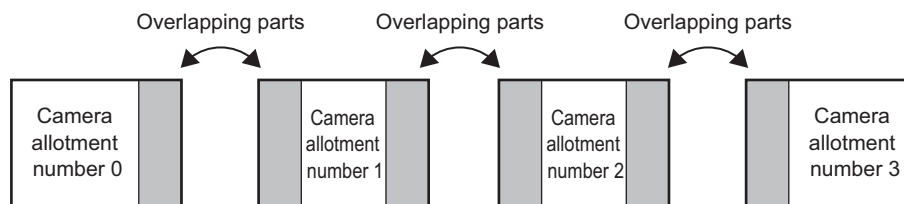

- 2 Adjust the image positions.
Use the Offset X and Y buttons on the setting screen to align the overlapping parts of the adjacent images that are being combined.

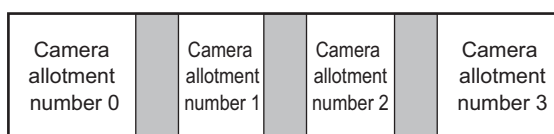

- 3 Combine the images.

Click **Combine** on the setting screen.

3-14-1 Camera Arrangement (Panorama)

Set the camera placement.

- 1** In the Item Tab area, click **Arrangement**.
- 2** In the *Display* area, click **Change display** and then select the type of camera images. The displayed contents of the *Image display* area will be switched.

Setting item	Setting value [Factory default]	Description
Display	<ul style="list-style-type: none"> • Through image • [Freeze image] 	<ul style="list-style-type: none"> • Through image: The latest image is always loaded from the camera and displayed. • Freeze image: The image loaded in the immediately preceding measurement is displayed.

- 3** Set the image count in the *Camera allotment* display area. When setting the image count, the Camera No. is automatically displayed based on the set count.

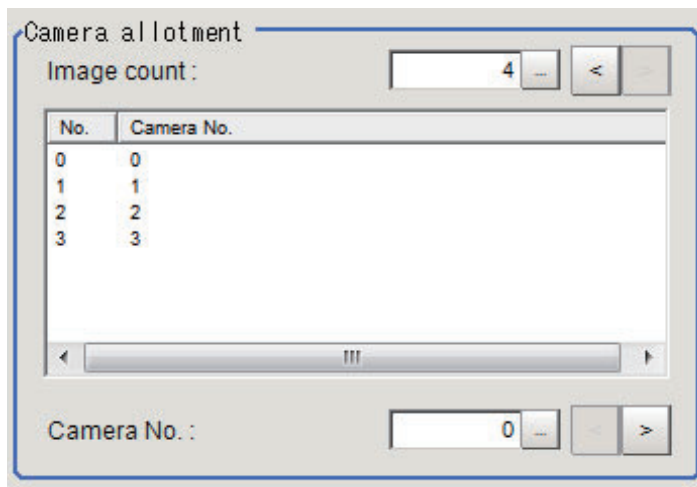

Setting item	Setting value [Factory default]	Description
No. of images	<ul style="list-style-type: none"> • [2] • 3 • 4 	<p>Sets the number of images to be combined.</p> <ul style="list-style-type: none"> • 2: Combines the images of camera allotment numbers 0 and 1. • 3: Combines the images of camera allotment numbers 0, 1, and 2. • 4: Combines the images of camera allotment numbers 0, 1, 2, and 3.

- 4** Set a camera number for each camera allotment number. The camera allotment numbers indicate the positions based on the camera arrangement and are fixed.

Assign the desired camera number to be combined to the camera allotment number.

Setting item	Setting value [Factory default]	Description
Camera number	Camera allotment number 0 • 0 to 7 [0] Camera allotment number 1 • 0 to 7 [1] Camera allotment number 2 • 0 to 7 [2] Camera allotment number 3 • 0 to 7 [3]	Sets the desired camera number to be combined to the camera allotment number.

5 Set the **Camera arrangement**.

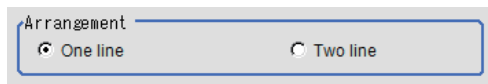

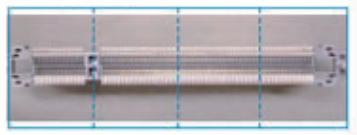
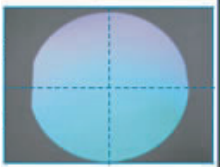
Setting item	Setting value [Factory default]	Description
Arrangement	<ul style="list-style-type: none"> [One line] Two line 	Selects the camera image placement. The camera allotment numbers are arranged as shown below and fixed. (one line) Camera arrangement  Camera allotment number 0 Camera allotment number 1 Camera allotment number 2 Camera allotment number 3 (two line) Camera arrangement  Camera allotment number 0 Camera allotment number 1 Camera allotment number 2 Camera allotment number 3



Precautions for Correct Use

- If the configuration of the connected cameras is changed, the measurement result will be *NG (incompatible image)*. Press **Initialize** and perform the settings again.
- Do not set *Camera Image Input* processing item or *Camera Image Input HDR* processing item after *Panorama* processing item.

3-14-2 Image Combination (Panorama)

Set the image combination method.

1 In the Item Tab area, click **Combine**.

2 In the *Position* area, set each item.

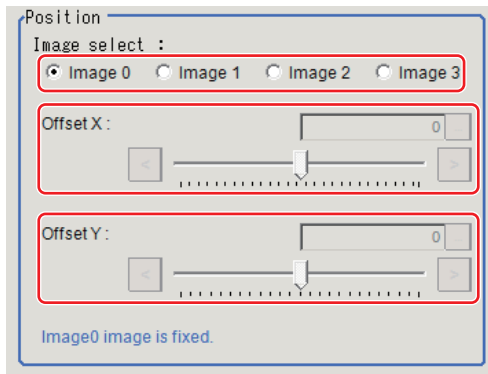

Setting item	Setting value [Factory default]	Description
Image select	<ul style="list-style-type: none"> • [Image 0] • Image 1 • Image 2 • Image 3 	<p>Selects the camera allotment number to adjust the combined position.</p> <p>The camera allotment number 0 is fixed. Adjust the camera allotment number 1 and later so that they are in the position to combine. The selectable camera allotment numbers depend on the number of images of the camera arrangement.</p>
Offset X	<ul style="list-style-type: none"> • FZ-S□ / FZ-SF□ / FZ-SP□ / FH-S□: -640 to 640 [0] • FZ-S□2M: -1,600 to 1,600 [0] • FZ-S□5M3 / FH-S□X05: -2,448 to 2,448 [0] • FH-S□02: -2,040 to 2,040 [0] • FH-S□04: -2,040 to 2,040 [0] • FH-S□12: -4,084 to 4,084 [0] • FH-S□X: -720 to 720 [0] • FH-S□X01: -1,440 to 1,440 [0] • FH-S□X03: -2,046 to 2,046 [0] • FH-S□X12: -4,092 to 4,092 [0] • FH-S□05R: -2,592 to 2,592 [0] • FH-S□21R: -5,544 to 5,544 [0] 	<p>Adjusts the selected camera image in the X direction.</p>

Setting item	Setting value [Factory default]	Description
Offset Y	<ul style="list-style-type: none"> FZ-S□ / FZ-SF□ / FZ-SP□ / FH-S□: -480 to 480 [0] FZ-S□2M: -1,200 to 1,200 [0] FZ-S□5M3 / FH-S□X05: -2,048 to 2,048 [0] FH-S□02: -1,088 to 1,088 [0] FH-S□04: -2,048 to 2,048 [0] FH-S□12: -3,072 to 3,072 [0] FH-S□X: -540 to 540 [0] FH-S□X01: -1,080 to 1,080 [0] FH-S□X03: -1,536 to 1,536 [0] FH-S□X12: -3,000 to 3,000 [0] FH-S□05R: -1,944 to 1,944 [0] FH-S□21R: -3,692 to 3,692 [0] 	Adjust the selected camera image in the Y direction.

3 In the *Combine* setting area, set the combination method.

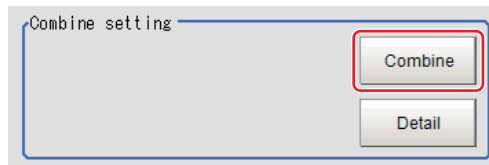

Setting item	Setting value [Factory default]	Description
Combine	-	Detects the same points among camera images (same location on the object as positioned differently on the different images) as the feature points, so that they are overlapped each other to generate panorama combination.

4 Set details as necessary.

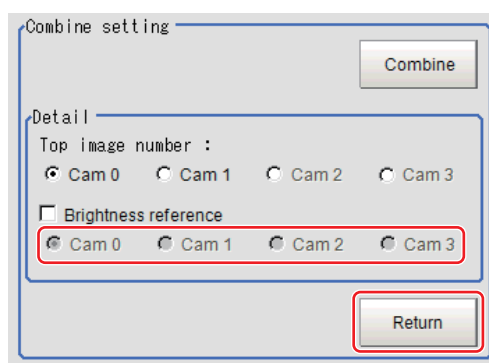

Setting item	Setting value [Factory default]	Description
Top image number	<ul style="list-style-type: none"> [Cam 0] Cam 1 Cam 2 Cam 3 	Selects the number of camera image to display on top. The order of images is changed with the selected number order.

Setting item	Setting value [Factory default]	Description
Brightness refer- ence	<ul style="list-style-type: none"> • Checked • [Unchecked] 	Places a check when there is brightness variation among the camera images.
	<ul style="list-style-type: none"> • [Cam 0] • Cam 1 • Cam 2 • Cam 3 	<p>Sets the number of the camera to be used as a reference for brightness correction.</p> <p>The brightness of the selected camera image is used as the reference to adjust the brightness of other cameras.</p>

- Restoring the settings to the initial states
Click **Initialize** to restore the initial settings.



5 Set the drawing settings as necessary.



Setting item	Setting value [Factory default]	Description
Image frame	<ul style="list-style-type: none"> • [Checked] • Unchecked 	Selects whether or not to display the image frame.
Matching points	<ul style="list-style-type: none"> • [Checked] • Unchecked 	Selects whether or not to display the feature points.

3-14-3 Key Points for Test Measurement and Adjustment (Panorama)

The image specified in the Sub-image number in the image display setting is displayed in the *Image Display* area.

Sub-image number	Description of image to be displayed
0	Post-combination image

Key Points for Adjustment (Panorama)

Adjust the setting parameters referring to the following points.

● If grid point combination fails

Parameter to be adjusted	Remedy
Offset X, Offset Y	When the width of the overlapping part of images is small, set the offset so that one-fourth of each image overlaps with each other. Set the camera so that the one-fourth of the field of views between cameras overlaps with each other.
Input image	When parts of superimposed images have no characteristics, use images with characteristics when setting it.

3-14-4 Measurement Results for Which Output Is Possible (Panorama)

The following values can be output using processing items related to result output. It is also possible to reference measurement values from calculation expressions and other processing units.

Measurement items	Character string	Description
Judge	JG	Judgment results 0: No judgment (unmeasured) 1: Judgment result OK -1: Judgment result NG -10: Error (image format mismatch) -11: Error (unregistered model) -12: Error (insufficient memory) -20: Error (other errors)

3-14-5 External Reference Tables (Panorama)

No.	Data name	Data ident	Set/Get	Data range
0	Judge	judge	Get only	0: No judgment (unmeasured), 1: Judgment result OK, -1: Judgment result NG, -10: Error (image format mismatch), -11: Error (unregistered model), -12: Error (insufficient memory), -20: Error (other errors)

4

Support Inspection and Measurement

This chapter describes how to set calculations and how to get or view data.

4-1	Unit Macro	4-6
4-2	Unit Calculation Macro	4-7
4-2-1	External Reference Tables (Unit Calculation Macro).....	4-7
4-3	Calculation	4-8
4-3-1	Settings (Calculation).....	4-9
4-3-2	Output parameter (Calculation)	4-11
4-3-3	Layout of Setting Expression Window (Calculation)	4-12
4-3-4	Expression Usage Examples (Calculation).....	4-16
4-3-5	Key Points for Test Measurement and Adjustment (Calculation).....	4-19
4-3-6	Measurement Results for Which Output Is Possible (Calculation)	4-20
4-3-7	External Reference Tables (Calculation)	4-20
4-4	Line Regression	4-22
4-4-1	Function Selection (Line Regression).....	4-22
4-4-2	Line 0 (Line Regression).....	4-23
4-4-3	Line 1 (Line Regression).....	4-24
4-4-4	Point (Line Regression)	4-24
4-4-5	Key Points for Test Measurement and Adjustment (Line Regression)	4-25
4-4-6	Measurement Results for Which Output Is Possible (Line Regression)	4-25
4-4-7	External Reference Tables (Line Regression)	4-26
4-5	Circle Regression	4-28
4-5-1	Parameter Settings (Circle Regression)	4-28
4-5-2	Key Points for Test Measurement and Adjustment (Circle Regression)	4-29
4-5-3	Measurement Results for Which Output Is Possible (Circle Regression).....	4-29
4-5-4	External Reference Tables (Circle Regression).....	4-30
4-6	Precise Calibration	4-32
4-6-1	Calibration (Precise Calibration)	4-33
4-6-2	Height Adjustment (Precise Calibration).....	4-39
4-6-3	Image Correction (Precise Calibration).....	4-40
4-6-4	Measurement Results for Which Output Is Possible (Precise Calibration)...	4-40
4-6-5	External Reference Tables (Precise Calibration)	4-41
4-7	User Data	4-42
4-7-1	Settings Flow (User Data).....	4-42
4-7-2	Settings (User Data)	4-43
4-7-3	Key Points for Test Measurement and Adjustment (User Data)	4-44
4-7-4	Measurement Results For Which Output Is Possible (User Data).....	4-44
4-7-5	External Reference Tables (Set User Data).....	4-45

4-8	Set Unit Data	4-46
4-8-1	Parameter Settings (Set Unit Data).....	4-46
4-8-2	Key Points for Test Measurement and Adjustment (Set Unit Data).....	4-48
4-8-3	Measurement Results for Which Output Is Possible (Set Unit Data).....	4-48
4-8-4	External Reference Tables (Set Unit Data).....	4-49
4-9	Get Unit Data	4-50
4-9-1	Parameter Settings (Get Unit Data).....	4-50
4-9-2	Measurement Results for Which Output Is Possible (Get Unit Data).....	4-51
4-9-3	External Reference Tables (Get Unit Data).....	4-52
4-10	Set Unit Figure	4-53
4-10-1	Parameter Settings (Set Unit Figure).....	4-53
4-10-2	Key Points for Test Measurement and Adjustment (Set Unit Figure).....	4-55
4-10-3	Measurement Results for Which Output Is Possible (Set Unit Figure).....	4-55
4-10-4	External Reference Tables (Set Unit Figure).....	4-56
4-11	Get Unit Figure	4-60
4-11-1	Parameter Settings (Get Unit Figure).....	4-60
4-11-2	Key Points for Test Measurement and Adjustment (Get Unit Figure).....	4-60
4-11-3	Measurement Results for Which Output Is Possible (Get Unit Figure).....	4-61
4-11-4	External Reference Tables (Get Unit Figure).....	4-63
4-12	Trend Monitor	4-67
4-12-1	Measurement Values (Trend Monitor).....	4-68
4-12-2	Display Range (Trend Monitor).....	4-68
4-12-3	Judgment (Trend Monitor).....	4-71
4-12-4	Measurement History Display (Trend Monitor).....	4-72
4-12-5	Data Save (Trend Monitor).....	4-74
4-12-6	Output parameter (Trend Monitor).....	4-76
4-12-7	Key Points for Test Measurement and Adjustment (Trend Monitor).....	4-76
4-12-8	Measurement Results for Which Output Is Possible (Trend Monitor).....	4-77
4-12-9	External Reference Tables (Trend Monitor).....	4-78
4-13	Image Logging	4-80
4-13-1	Logging Conditions (Image Logging).....	4-80
4-13-2	Save Destination (Image Logging).....	4-81
4-13-3	Key Points for Test Measurement and Adjustment (Image Logging).....	4-83
4-13-4	Measurement Results for Which Output Is Possible (Image Logging).....	4-83
4-13-5	External Reference Tables (Image Logging).....	4-84
4-14	Image Conversion Logging	4-85
4-14-1	Save Conditions (Image Conversion Logging).....	4-85
4-14-2	Destination (Image Conversion Logging).....	4-87
4-14-3	Area Setting (Image Conversion Logging).....	4-88
4-14-4	Key Points for Test Measurement and Adjustment (Image Conversion Logging).....	4-88
4-14-5	Measurement Results for Which Output Is Possible (Image Conversion Logging).....	4-88
4-14-6	External Reference Tables (Image Conversion Logging).....	4-89
4-15	Data Logging	4-91
4-15-1	Settings (Data Logging).....	4-92
4-15-2	Output Format (Data Logging).....	4-92
4-15-3	Additional Explanation (Data Logging).....	4-95
4-15-4	Measurement Results for Which Output Is Possible (Data Logging).....	4-96
4-15-5	External Reference Tables (Data Logging).....	4-96
4-16	Elapsed Time	4-98
4-16-1	Measurement Results for Which Output Is Possible (Elapsed Time).....	4-99
4-16-2	External Reference Tables (Elapsed Time).....	4-99
4-17	Wait	4-100
4-17-1	Settings (Wait).....	4-100
4-17-2	External Reference Tables (Wait).....	4-100
4-18	Focus	4-101
4-18-1	Measurement Parameters (Focus).....	4-101

4-18-2	Region Setting (Focus)	4-102
4-18-3	Output parameter (Focus)	4-102
4-18-4	Key Points for Test Measurement and Adjustment (Focus).....	4-103
4-18-5	External Reference Tables (Focus)	4-103
4-19	Iris	4-106
4-19-1	Measurement Parameters (Iris)	4-106
4-19-2	Region Setting (Iris)	4-108
4-19-3	Output parameter (Iris)	4-108
4-19-4	Key Points for Test Measurement and Adjustment (Iris).....	4-108
4-19-5	External Reference Tables (Iris)	4-109
4-20	Parallelize	4-112
4-21	Parallelize Task	4-113
4-22	Statistics	4-114
4-22-1	Settings Flow (Statistics)	4-114
4-22-2	Statistical Parameters (Statistics)	4-114
4-22-3	Data Setting (Statistics)	4-115
4-22-4	Data Display (Statistics).....	4-116
4-22-5	Output Parameters (Statistics).....	4-118
4-22-6	Key Points for Test Measurement and Adjustment (Statistics)	4-118
4-22-7	Measurement Results for Which Output Is Possible (Statistics).....	4-119
4-22-8	External Reference Tables (Statistics).....	4-120
4-23	Calibration Data Reference	4-122
4-23-1	Settings Flow (Calibration Data Reference)	4-122
4-23-2	Calibration (Calibration Data Reference).....	4-123
4-23-3	Distortion Correction (Calibration Data Reference)	4-124
4-23-4	Key Points for Test Measurement and Adjustment (Calibration Data Reference).....	4-125
4-23-5	Measurement Results for Which Output Is Possible (Calibration Data Reference).....	4-126
4-23-6	External Reference Tables (Calibration Data Reference).....	4-126
4-24	Position Data Calculation	4-128
4-24-1	Settings Flow (Position Data Calculation).....	4-128
4-24-2	Calculation Setting (Position Data Calculation)	4-129
4-24-3	Output parameter (Position Data Calculation)	4-133
4-24-4	Key Points for Test Measurement and Adjustment (Position Data Calculation)	4-133
4-24-5	Measurement Results for Which Output Is Possible (Position Data Calculation)	4-133
4-24-6	External Reference Tables (Position Data Calculation).....	4-134
4-25	Robot Data	4-137
4-25-1	Data Setting (Robot Data)	4-137
4-25-2	Measurement Results for Which Output Is Possible (Robot Data).....	4-141
4-25-3	External Reference Tables (Robot Data)	4-141
4-26	Vision Master Calibration	4-143
4-26-1	Settings Flow (Vision Master Calibration).....	4-144
4-26-2	Machine Setting (Vision Master Calibration).....	4-144
4-26-3	Calibration (Vision Master Calibration)	4-145
4-26-4	Sampling Setting (Vision Master Calibration)	4-149
4-26-5	Calibration Result (Vision Master Calibration)	4-162
4-26-6	Key Points for Test Measurement and Adjustment (Vision Master Calibration).....	4-168
4-26-7	Measurement Results for Which Output Is Possible (Vision Master Calibration).....	4-170
4-26-8	External Reference Tables (Vision Master Calibration)	4-171
4-27	PLC Master Calibration	4-176
4-27-1	Settings Flow (PLC Master Calibration).....	4-177
4-27-2	Machine Setting (PLC Master Calibration)	4-177
4-27-3	Calibration (PLC Master Calibration).....	4-178
4-27-4	Sampling Setting (PLC Master Calibration).....	4-180

4-27-5	Calibration Result (PLC Master Calibration).....	4-181
4-27-6	Key Points for Test Measurement and Adjustment (PLC Master Calibration).....	4-182
4-27-7	Measurement Results for Which Output Is Possible (PLC Master Calibration).....	4-183
4-27-8	External Reference Tables (PLC Master Calibration).....	4-184
4-28	Transfer Position Data	4-187
4-28-1	Settings Flow (Transfer Position Data).....	4-187
4-28-2	Machine Setting (Transfer Position Data).....	4-188
4-28-3	Transfer Parameter (Transfer Position Data).....	4-189
4-28-4	Output parameter (Transfer Position Data).....	4-194
4-28-5	Key Points for Test Measurement and Adjustment (Transfer Position Data).....	4-194
4-28-6	Measurement Results for Which Output Is Possible (Transfer Position Data).....	4-195
4-28-7	External Reference Tables (Transfer Position Data).....	4-195
4-29	Calc Axis Move	4-197
4-29-1	Settings Flow (Calc Axis Move).....	4-197
4-29-2	Machine Setting (Calc Axis Move).....	4-198
4-29-3	Calc. Parameter (Calc Axis Move).....	4-199
4-29-4	Judgment Condition (Calc Axis Move).....	4-202
4-29-5	Output Parameter (Calc Axis Move).....	4-204
4-29-6	Key Points for Test Measurement and Adjustment (Calc Axis Move).....	4-205
4-29-7	Measurement Results for Which Output Is Possible (Calc Axis Move).....	4-207
4-29-8	External Reference Tables (Calc Axis Move).....	4-209
4-30	Calc Axis Move by Multipoint.....	4-212
4-30-1	Settings Flow (Calc Axis Move by Multipoint).....	4-212
4-30-2	Machine Setting (Calc Axis Move by Multipoint).....	4-213
4-30-3	Calc. Parameter (Calc Axis Move by Multipoint).....	4-214
4-30-4	Judgement Condition (Calc Axis Move by Multipoint).....	4-219
4-30-5	Output Parameter (Calc Axis Move by Multipoint).....	4-222
4-30-6	Key Points for Test Measurement and Adjustment (Calc Axis Move by Multipoint).....	4-222
4-30-7	Measurement Results for Which Output Is Possible (Calc Axis Move by Multipoint).....	4-224
4-30-8	External Reference Tables (Calc Axis Move by Multipoint).....	4-225
4-31	Detection Point.....	4-228
4-31-1	Parameter Setting (Detection Point).....	4-229
4-31-2	Measurement Results for Which Output Is Possible (Detection Point).....	4-229
4-31-3	External Reference Tables (Detection Point).....	4-230
4-32	Manual Position Setting	4-231
4-32-1	Settings Flow (Manual Position Setting).....	4-234
4-32-2	Data Setting (Manual Position Setting).....	4-236
4-32-3	Position Setting (Manual Position Setting).....	4-242
4-32-4	Measurement Results for Which Output Is Possible (Manual Position Setting).....	4-247
4-32-5	External Reference Tables (Manual Position Setting).....	4-247
4-33	Camera Calibration	4-249
4-33-1	Settings Flow (Camera Calibration).....	4-249
4-33-2	Specify Point (Camera Calibration).....	4-250
4-33-3	Value Appointment (Camera Calibration).....	4-251
4-33-4	Sampling (Camera Calibration).....	4-253
4-33-5	Dimension Measure (Camera Calibration).....	4-255
4-33-6	Data Display (Camera Calibration).....	4-258
4-33-7	Measurement Results for Which Output Is Possible (Camera Calibration).....	4-261
4-33-8	External Reference Tables (Camera Calibration).....	4-261
4-34	Data Save	4-265
4-34-1	Setting (Data Save).....	4-265
4-34-2	Key Points for Test Measurement and Adjustment (Data Save).....	4-266
4-34-3	Measurement Results for Which Output Is Possible (Data Save).....	4-267

4-34-4	External Reference Tables (Data Save)	4-267
4-35	Stage Data.....	4-268
4-35-1	Data Setting (Stage Data).....	4-268
4-35-2	Measurement Results for Which Output Is Possible (Stage Data).....	4-290
4-35-3	External Reference Tables (Stage Data)	4-290
4-36	Conveyor Calibration.....	4-293
4-37	Scene.....	4-294
4-37-1	Scene Setting (Scene).....	4-295
4-37-2	External Reference Tables (Scene).....	4-301
4-38	System Information.....	4-302
4-38-1	Usage	4-302
4-38-2	Available System Information (System information)	4-302
4-38-3	External Reference Tables (System information)	4-304

4-1 Unit Macro

This processing item is not available in the FHV series.

User's original measurement processing can be performed.

Unit macros are convenient if you want to build a new measurement processing by combining filters and measurement processing's, create a complex display that cannot be realized with the result display processing items, or write original text in the detail text display.

Used in the Following Case

- When the processing performed by multiple processing items such as looping or branching can be combined into one.
Ex. When performing Search processing after performing filtering several times
 - Using a measurement flow: Combining filters, Calculation, Conditional Branch, and Search processing items.
 - Using unit macros: Defining the processing to perform Search measurement processing after performing filter measurements multiple times by adding filters and Search to a measurement flow. Using unit macros makes a measurement flow structure simple.



Precautions for Correct Use

Unit macros cannot be edited by remote operation.

Regarding the specifications for Unit Macro and items to be set with Unit Macro, refer to *Description of the Setting Screen of the Unit Macro processing item and How to Configure Settings* in the *Vision System FH Series Macro Customize Functions Programming Manual* (Cat. No. 367).

4-2 Unit Calculation Macro

This processing item is not available in the FHV series.

You can perform calculations, as well as setting/acquiring.

This function is convenient when the user wants to calculate a value using an original calculation formula or change the set value or system data of a processing item.

Used in the Following Case

- Possible to combine the processing performed by multiple processing items such as looping or branching into one.
Ex. When using a different calculating equation according to conditions.
 - Using a measurement flow: Combining Conditional Branch and Calculation.
 - Using unit macros: Define a calculating processing with a calculation equation according to the conditions of Unit Calculation Macro processing item.
 Using unit calculation macros makes a measurement flow structure simple.
- Possible to combine the processing done by multiple processing items such as changing settings for multiple processing items according to conditions can be combined into one.
Ex. When changing the extraction conditions for labeling based on the sorting results
 - Using a measurement flow: Combining Conditional Branch, Calculation, and Set Unit Data processing items.
 - Using unit calculation macros: Defining the processing to assign values to the variables according to conditions by registering variables as reference variables for labeling extraction conditions.
 Using unit calculation macros makes a measurement flow structure simple.

Regarding the specifications for Unit Calculation Macro and items to be set with Unit Calculation Macro, refer to *Description of the Setting Screen of the Unit Calculation Macro processing item and How to Configure Settings* in the *Vision System FH Series Macro Customize Functions Programming Manual* (Cat. No. 367).

4-2-1 External Reference Tables (Unit Calculation Macro)

No.	Data name	Data ident	Set/Get	Data range
0	Judge	judge	Get only	0: No judgment (unmeasured), 1: Judgment result OK, -1: Judgment result NG, -10: Error (image format mismatch), -11 :Error (unregistered model), -12: Error (insufficient memory), -20: Error (other errors)
5+N (N=0 to 31)	Calculation result	resultData00 to resultData31	Set/Get	-
37+N (N=0 to 31)	Judgement result	resultJudge00 to resultJudge31	Set/Get	0: No judgment (unmeasured), 1: Judgment result OK, -1: Judgment result NG

4-3 Calculation

Used in the Following Case

- When changing the inspection details using calculation results:

Example) Calculating the width of the measurement object Width calculation can be performed by first calculating two edge positions and setting up the arithmetic expression which is used to calculate the edge position difference.

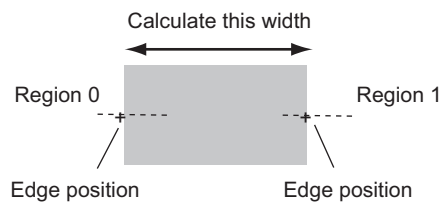

Width = the edge position of Area 0 – the edge position of Area 1

By combining Calculation and Conditional Branch, the following measurement contents can be changed based on the operational result.

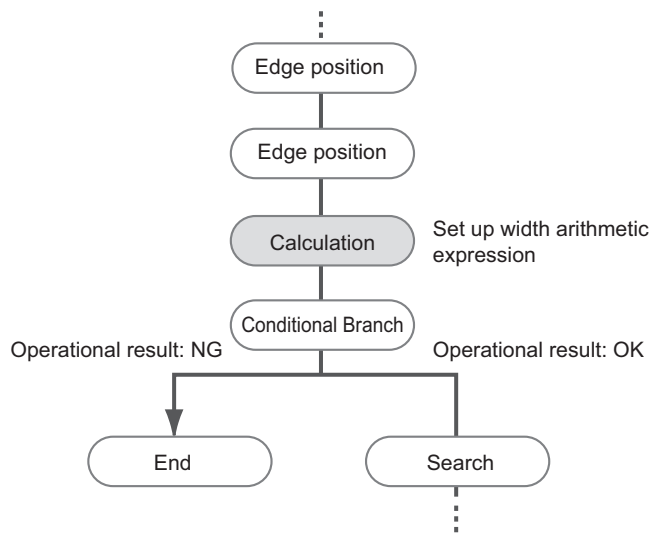

- When performing calculation by using calculation results from other processing units:

4-3-1 Settings (Calculation)

The number of calculation expressions possible to set up in one unit is up to 32. When using more than that, use multiple processing units.

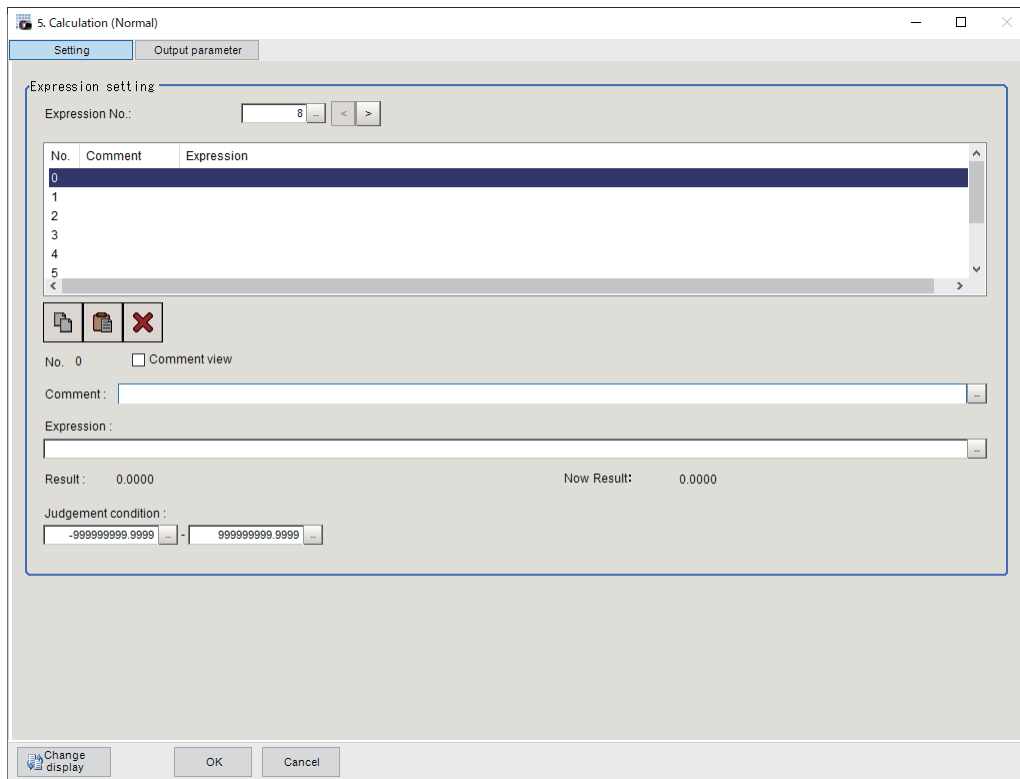

Additional Information

Just setting up calculation expressions does not output calculation results to external devices. When to do so, using the flow editing, set processing items related to *Output Result* after the *Calculation* in the measurement flow. For details, refer to *Section 6 Output Result* on page 6-1.

- 1** In the Item tab area, click **Setting**.
- 2** Set the *Expression No.* to set up.
Expression No. is up to 32. By increasing or decreasing the *number of settings*, the displayed data in the *Expression setting* area follows it.
- 3** Click *No.* to set up the calculation expression from the list in the **Expression setting** area.
The selected number is displayed below the list.

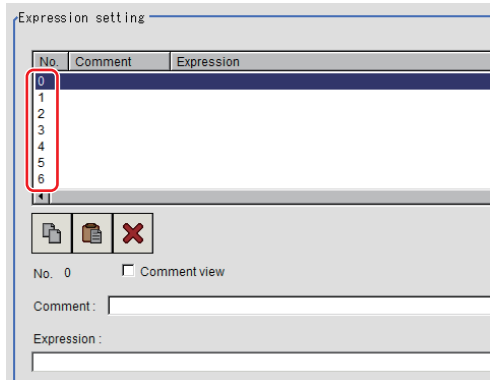

- 4 Click  at the right of the *Expression* text box.
The *Setting expression* dialog is displayed.

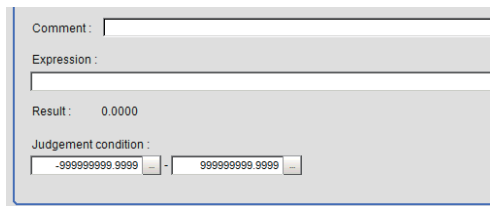

- 5 Set up the calculation expression.
Submenus for the settings are displayed according to processing units and variables. Selecting and clicking an item in the submenu adds it to the calculation expression.
For details, refer to *4-3-3 Layout of Setting Expression Window (Calculation)* on page 4-12.

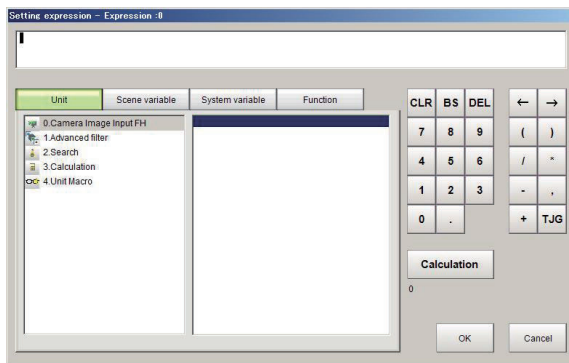

- 6 Click **Calculation** to check the validity of the calculation expression.
When executing it, the calculation result is displayed in black under **Calculation**.
If there is an error, a message of *Error of the expression* is displayed in red.



Additional Information

If an error message is displayed, check the following.

- Unit value, numeric, function, or T.J.G should be set just before or after operators.
- Operators and commas should not be set at the start or end of an expression.
- Operators cannot be set continuously.
- Values and functions of T.J.G and units cannot be set continuously.
- Should use the right and left parentheses () in a pair.
- Make sure to set function arguments.

- 7 After setting up the expression, click **OK**.
The value of *Now result* is updated when the expression was completed.

If clicking **OK** while there is an error in the calculation expression, a dialog of *Error of the expression* is displayed. Correct the calculation expression.

- 8** Click  for the **Comment** to add a description of the calculation expression as necessary. Multilingual is supported.
For details, refer to *Inputting Text* in the *Vision System FH/FHV Series User's Manual* (Cat. No. Z365).

- 9** Place a check to *Comment view* to display it in the **Detail Result Pane** area,

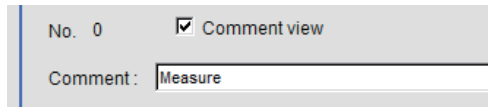

- 10** Set the upper and lower judgment limits in the *Judgment condition*.

Setting item	Setting value	Description
Judgment condition	-999,999,999.9999 to 999,999,999.9999	This judgment condition is for the expression. Set the upper and lower limits to judge OK.

- 11** Repeat step 2 to 8 to set the expression.

4-3-2 Output parameter (Calculation)

Select whether or not to reflect the judgment results of this processing unit to the overall judgment of the scene.

- 1** In the Item tab area, click **Output parameter**.
- 2** Select whether or not to reflect it to the overall judgment in *Reflect to overall judgement* area.

Setting item	Setting value [Factory default]	Description
Reflect to overall judgment	<ul style="list-style-type: none"> • [ON] • OFF 	Enables choosing whether or not the judgement results of this processing unit is reflected in the scene overall judgment.

4-3-3 Layout of Setting Expression Window (Calculation)

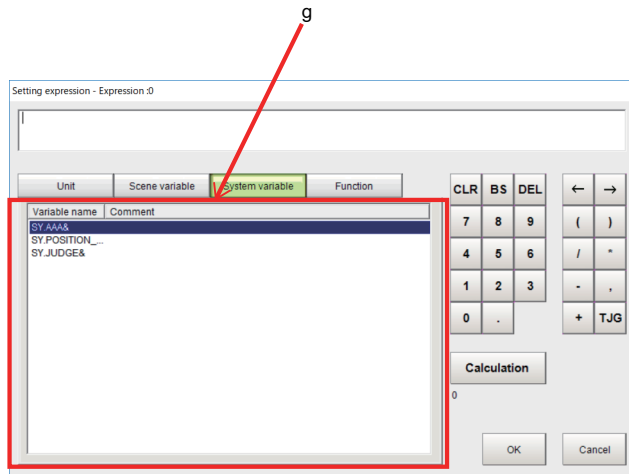
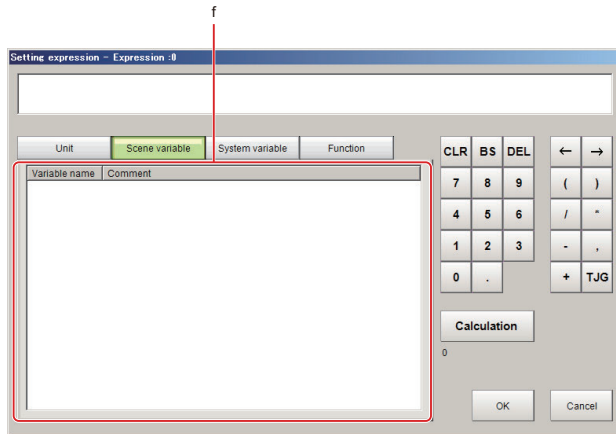
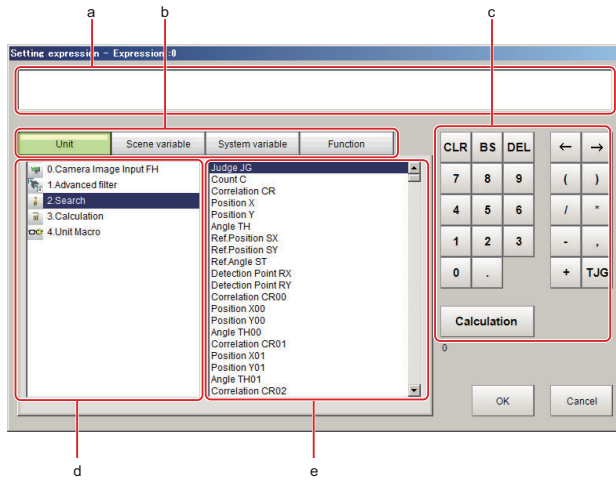

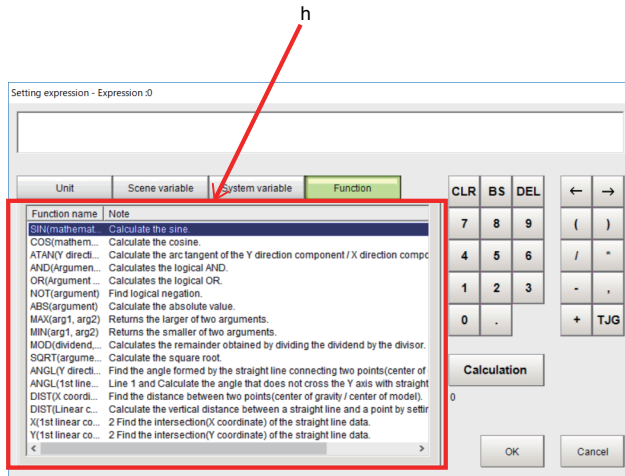

a. Expression Display Area:

This area is for setting expressions. The expressions are displayed in the following manner.

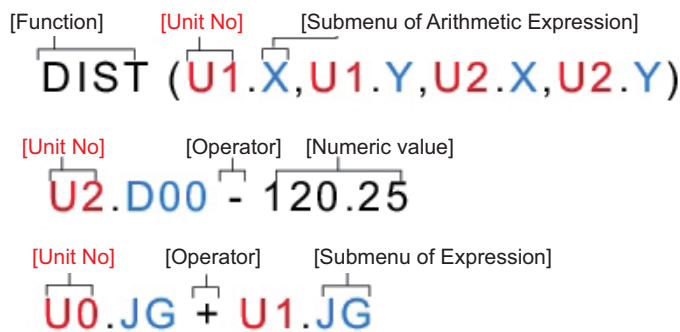

b. Unit/Variable Tab:

Tabs for selecting input objects for expressions: **Unit**, **Scene**, **System**, and **Function**. The Expression Setting window varies depending on the selected object.

- Unit tab: Measurement flow display area and data area
- Scene variable tab: Scene variable list area
- System variable tab: System variable list area
- Function tab: Function list area

c. General Button Area:

These common buttons are required for editing expressions. Numbers and operators can be input here.

Button	Type	Description
CLR	-	Deletes input contents in the expression display area.
BS	-	Deletes the item immediately before the cursor in the expression display area.
DEL	-	Deletes the item immediately follow the cursor in the expression display area.
0 to 9	Numerical number	Numbers will be displayed at the cursor position in the expression display area. The number range that can be set up is from -999,999,999.9999 to 999,999,999.9999.
.	Symbol	A dot "." will be displayed at the cursor position in the expression display area.
←	Movement	The cursor in the expression display area moves one space to the left.

Button	Type	Description
→	Movement	The cursor in the expression display area moves one space to the right.
(Symbol	Used to set off the numerical expression. Used in pairs with ")".
)	Symbol	Used to set off the numerical expression. Used in pairs with "(".
/	Operator	Indicates division for real numbers.
*	Operator	Indicates multiplication
-	Operator	Indicates subtraction.
,	Symbol	A comma "," will be displayed at the cursor position in the expression display area.
+	Operator	Indicates addition.
TJG	-	Acquires the overall judgement result for all units ahead of the unit number in which an expression has been set. Refer to <i>5-1-3 Conditional Branch Settings Examples</i> on page 5-5.
CALCULATION	-	Executes the expression input in the Expression display area. Under the button, the calculation result value or an error message is displayed.

d. Measurement flow display area (Unit tab):

This is displayed when the Unit tab is selected.

Numbers and names of the processing units displayed in the current scene are displayed. When selecting a processing unit, available data for the calculation expression will be displayed in the Data list area.

For details, refer to *Measurement Results for Which Output Is Possible*.

e. Data list area (Unit tab):

This is displayed when the Unit tab is selected.

Available data for the calculation expression of a processing unit selected in the Measurement flow display area is displayed. Clicking data to input is possible to input it to the calculation expression in the Expression display area.

For details, refer to *Measurement Results for Which Output Is Possible*.

f. Scene variable list area (Scene tab):

Scene variables used in the current scene are displayed. Clicking a Scene variable to input is possible to input it to the calculation expression in the Expression display area.

g. System variable list area (System tab):

System variables used in the current scene are displayed. Clicking a System variable to input is possible to input it to the calculation expression in the Expression display area.

h. Function list area (Function tab):

Available functions for the calculation expression are displayed. Clicking a function to input is possible to input it in the Expression display area.

Function	Description
SIN (equation)	Calculates the sine. The calculation result will be returned within the range of -1 to 1. The angle to be set in the equation is set by degrees.
COS (equation)	Calculates the cosine. The calculation result will be returned within the range of -1 to 1. The angle to be set in the equation is set by degrees.

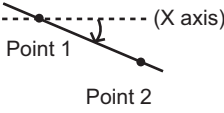
Function	Description
ATAN (Y-axis component, X-axis component)	Calculates the arc tangent of the Y-axis and X-axis components. The calculation result will be returned in radians within the range of $-\pi$ to π . Ex. When calculating the angle between X-axis and a straight line connecting the center of gravity of region 0 and that of region 1: ATAN (R1.Y-R0.Y,R1.X-R0.X) When both arguments are zero, zero will be returned in the calculation result and the judgement will be OK.
AND (rag. 1, rag. 2)	Calculates the logical product. When either one of two arguments is zero, zero will be returned in the calculation result. In other cases, -1 will be returned.
OR (rag. 1, rag. 2)	Calculates the logical sum. When both arguments are zero, zero will be returned in the calculation result. In other cases, -1 will be returned.
NOT (rag.)	Calculates the logical negation. When the argument is zero, -1 will be returned in the calculation result. In other cases, zero will be returned.
ABS (rag.)	Calculates the absolute value.
MAX (rag. 1, rag. 2)	The larger value in two arguments will be returned.
MIN (rag. 1, rag. 2)	The smaller value in two arguments will be returned.
MOD (dividend, divisor)	Calculates the remainder when dividing the dividend with the divisor. When a real number is used in the remainder calculation, the calculation is performed after rounding off the part of the decimal point of the real number. The result will be the remainder after the division of the integer. Ex.: MOD (13,4) Result: 1 (the remainder after dividing 13 by 4) MOD (25.68,6.99) ... Result: 5 (the remainder after dividing 26 by 7)
SQRT (rag.)	Calculates the square root. When an argument is a negative number, zero will be returned in the calculation result and the judgement will be NG.
ANGL (Y-axis component, X-axis component)	Calculates the angle between X-axis and a straight line connecting two points (center of gravity and center of the model). The calculation results will be returned within the range of -180 to 180. (Example) When calculating the angle produced by the straight lines that join the gravity of Area 0 and that Area 1 ANGL (R1.Y-R0.Y, R1.X-R0.X)  When both the two operands are equal to 0, "0" will be returned, and the judge will become NG.

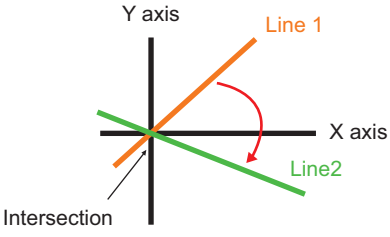
Function	Description
ANGL (1st linear coefficient A, 1st linear coefficient B, 1st linear coefficient C, 2nd linear coefficient A, 2nd linear coefficient B, 2nd linear coefficient C)	<p>Calculates the angle not to cross the Y-axis between Line 1 and Line 2. The same angle can be obtained distinction between both Line 1 and Line 2.</p>  <p>Ex.: When calculating an angle formed by two straight lines using the straight line data of scan edge position 1 and 2 ANGL (U1.A,U1.B,U1.C,U2.A,U2.B,U2.C)</p>
DIST (1st X-coordinate, 1st Y-coordinate, 2nd X-coordinate, 2nd Y-coordinate)	<p>Calculates the distance between two points (center of gravity and center of the model).</p> <p>(Example) When calculating the distance between the gravity of Area 0 and that of Area 1. DIST (R0.X,R0.Y,R1.X,R1.Y) The following calculation will be performed internally.</p> $\sqrt{(R1.X-R0.X)^2 + (R1.Y-R0.Y)^2}$
DIST (linear coefficient A, linear coefficient B, linear coefficient C, X-coordinate, Y-coordinate)	<p>Calculates the vertical distance between a line and a point by specifying the line and point.</p> <p>Ex.: When calculating the distance between the approximate line of the scan edge position 1 and the edge position of the scan edge position 2 DIST (U1.A,U1.B,U1.C,U2.X,U2.Y)</p>
X (1st linear coefficient A, 1st linear coefficient B, 1st linear coefficient C, 2nd linear coefficient A, 2nd linear coefficient B, 2nd linear coefficient C)	<p>Calculates the intersection (X-coordinate) of two straight line data.</p> <p>Ex.: When calculating the intersection X-coordinate of the scan edge position 1 and 2 X (U1.A,U1.B,U1.C,U2.A,U2.B,U2.C)</p>
Y (1st linear coefficient A, 1st linear coefficient B, 1st linear coefficient C, 2nd coefficient A, 2nd coefficient B, 2nd coefficient C)	<p>calculates the intersection (Y-coordinate) of two straight line data.</p> <p>Ex.: When calculating the intersection Y-coordinate of the scan edge position 1 and 2 Y (U1.A,U1.B,U1.C,U2.A,U2.B,U2.C)</p>

4-3-4 Expression Usage Examples (Calculation)

Perform judgement by combining the judgement results of unit 0 and unit 1

- **Example: Perform judgement by combining the judgement results of unit 0 and unit 1**

When both unit 0 and unit 1 were judged as OK, the calculation result will be judged as OK.

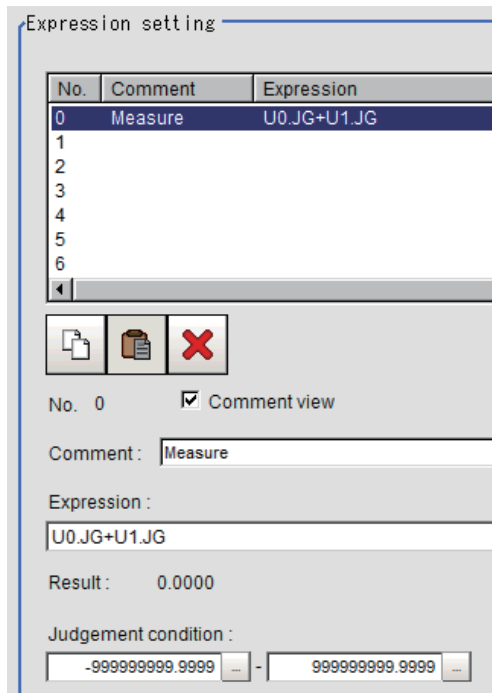

Step 1: Set the sum of the judgement result (U0.JG, U1.JG) of unit 0 and 1 to the calculation expression.

The sum of adding the judgement value (1: OK / -1: NG) based on the unit 0 judgement conditions and that based on the unit 1 judgement conditions is displayed on *Result*.

Step 2: The calculation result of step 1 is judged based on the judgement upper and lower limits. When 2 is set to both the judgement upper and lower limits, the calculation result will be judged as OK when both unit 0 and unit 1 were judged as OK.

Judgement results of unit 0 (Judgement value)	Judgement results of unit 1 (Judgement value)	Calculation expression result (Sum of judgement value for unit 0 and 1)	Judgement result of calculation expression
OK (1)	OK (1)	2	OK
NG (-1)	OK (1)	0	NG
OK (1)	NG (-1)	0	NG
NG (-1)	NG (-1)	-	NG





Using Values of Other Calculation Expressions

Up to 32 calculation expressions are available in one expression unit.

Values of the calculation expression set in the same expression unit are also available.

Since calculation results for the calculation expression to be used are displayed as D00 to D31 and judgement results for the used calculation expression are displayed as J00 to J31, set as *U3, D00* in *Unit number, Calculation results* (results of calculation expression 0 set for a processing item *Calculation* of unit number 3).

For the following scene settings:

	0.Camera Image Input FH
	1.Edge Position
	2.Edge Position
	3.Calculation

- **Example: Calculate the reference position distance and measurement results distance at the edge position and output the difference between the two distance**

Area of Unit 1

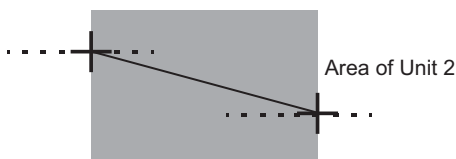

No. 0 Comment view

Comment : _____

Expression :
DIST(U1.SX,U1.SY,U2.SX,U2.SY)

Result : 385.6323

Judgement condition :
 -

No. 1 Comment view

Comment : _____

Expression :
DIST(U1.X,U1.Y,U2.X,U2.Y)

Result : 0.0000

Judgement condition :
 -

No. 2 Comment view

Comment : _____

Expression :
U3.D00-U3.D01

Substitute the operational results of Expression 0 (D00) and Expression 1 (D01)

Set calculation expressions in the following manner.

- Calculation 0: DIST (U1.SX,U1.SY,U2.SX,U2.SY)
This equation calculates the distance between two reference positions of unit 1 and 2. The function *DIST* calculates the distance between two points.
- Calculation 1: DIST (U1.X,U1.Y,U2.X,U2.Y)
This expression calculates the distance between two measurement positions of unit 1 and unit 2. The function *DIST* calculates the distance between two points.
- Calculation 2: U3.D01-U3.D00
(Unit 3: Calculation **Calculation 1** - Unit 3: Calculation **Calculation 0**)
This equation calculates the difference between results of Calculation 1 and Calculation 0 in unit 3 (in this example, **Operation**).



Precautions for Correct Use

Calculating order of calculation expressions:

An expression using results of other calculation expressions must be set with a higher calculation number than the substituted calculation number. If a smaller calculation number than the substituted calculation number were set, the previous calculation results will be set to the substituted calculation number.

Calculating order

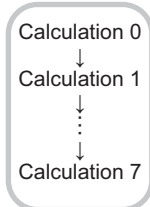

Calculate the distance between the two points in the inspection region in

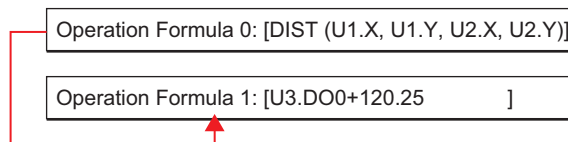

When you substitute these equations with each other

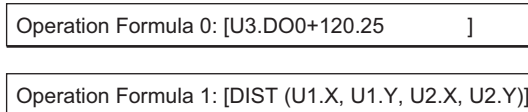

Since the calculation of operation formula 0 is earlier than operation formula 1, the last operation result of operation formula 1 will be substituted into U3 DO1

Counting Number of Measurements

The measurement count is counted by adding 1 to each calculation number 0.



Additional Information

- As calculation results are cleared or the power is turned off, U3.Doo will return to 0, therefore the measurement counts are also reset.
- When resetting the measurement counts per a certain count in a measurement processing, use a processing unit data setting for it.

4-3-5 Key Points for Test Measurement and Adjustment (Calculation)

The following content is displayed in the *Detail result* area as text.

Displayed item	Description
Judge	Judgment results 0: No judgment (unmeasured) 1: Judgment result OK -1: Judgment result NG -10: Error (image format mismatch) -11: Error (unregistered model) -12: Error (insufficient memory) -20: Error (other errors)
Expression 0 to 31	Expression result of Expression 0 to 31

4-3-6 Measurement Results for Which Output Is Possible (Calculation)

The following values can be output using processing items related to result output. It is also possible to reference measurement values from calculation expressions and other processing units.

Measurement items	Character string	Description
Judge	JG	Judgment results 0: No judgment (unmeasured) 1: Judgment result OK -1: Judgment result NG -10: Error (image format mismatch) -11: Error (unregistered model) -12: Error (insufficient memory) -20: Error (other errors)
Data 0 to 31	D00 to 31	Expression result of expression 0 to 31
judgment 0 to 31	J00 to 31	judgment result of expression 0 to 31

4-3-7 External Reference Tables (Calculation)

No.	Data name	Data ident	Set/Get	Data range
0	Judge	judge	Get only	0: No judgment (unmeasured), 1: Judgment result OK, -1: Judgment result NG, -10: Error (image format mismatch), -11: Error (unregistered model), -12: Error (insufficient memory), -20: Error (other errors)
103	Reflect to overall judgement	overallJudge	Set/Get	0: ON, 1: OFF
170	Number of Expression	dataNum	Set/Get	8 to 32
1,000+N (N=0 to 31)	Expression result of Expression	resultData00 to resultData31	Set/Get	-999,999,999.9999 to 999,999,999.9999
1,100+N (N=0 to 31)	Judgement result of Expression	resultJudge00 to resultJudge31	Set/Get	0: Unmeasured, 1: OK, -1: NG
1,200+N (N=0 to 31)	Upper limit for judgement	upperCalc00 to upperCalc31	Set/Get	-999,999,999.9999 to 999,999,999.9999
1,300+N (N=0 to 31)	Lower limit for judgement	lowerCalc00 to lowerCalc31	Set/Get	-999,999,999.9999 to 999,999,999.9999

No.	Data name	Data ident	Set/Get	Data range
1,400+N (N=0 to 31)	Expressions	setupData00 to setupData31	Set/Get	Exp. character string
1,500+N (N=0 to 31)	Expressions comment	comment00 to comment31	Set/Get	Character string
1,600+N (N=0 to 31)	Comment view	commentView00 to commentView31	Set/Get	0: OFF, 1: ON

4-4 Line Regression

Calculates the line that generates the shortest total distance from multiple measurement coordinates (Line Regression).

It can also calculate the intersection and angle between two lines and the distance between a line and a point.

Used in the Following Case

For calculating the intersection and distance of lines by computing lines

• Approximate multiple measurement coordinates with a straight line

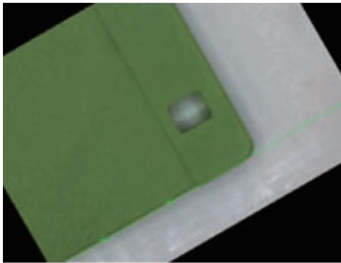

• Calculate the intersection and angles of two lines.

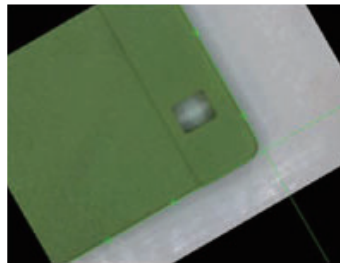

• Calculate the distance from the line to the point

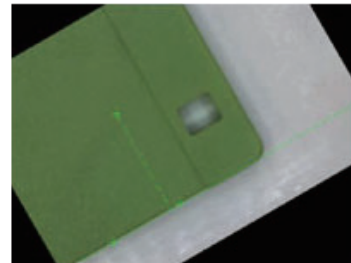

Precautions for Correct Use

Do not set processing units that perform affine transformations such as position correction between Line Regression and a unit that inputs for Line Regression.

4-4-1 Function Selection (Line Regression)

Here, select functions depending on applications.

1 In the Item Tab area, click **Select function**.

2 Select a function in the *Select function* area.

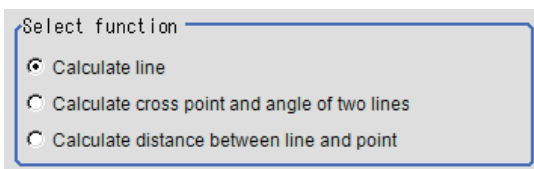

Setting item	Setting value [Factory default]	Description
Select function	<ul style="list-style-type: none"> [Calculate line] Calculate cross point and angle of two lines Calculate distance between line and point 	<ul style="list-style-type: none"> Calculate line Calculates a straight line providing the shortest distance from multiple points (Line Regression). Sets the Line 0 tab. Calculate cross point and angle of two lines Calculates the intersection and angle between two Line Regressions. Set tabs for Line 0 and Line 1. The angle is formed from Line 0 to Line 1 in clockwise order. Calculate distance between line and point Calculates distance between a Line Regression and a point. Set tabs for Line 0 and Line 1.

4-4-2 Line 0 (Line Regression)

- 1 in the Item Tab area, click **Line 0**.
- 2 Set this to remove noise points when calculating straight lines.

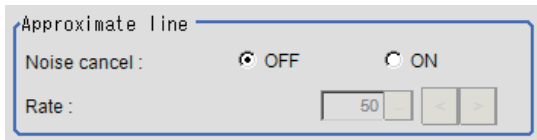

Setting item	Setting value [Factory default]	Description
Noise cancel	<ul style="list-style-type: none"> [OFF] ON 	When placing a check at <i>ON</i> , an approximate line is calculated by excluding the points with large deviation among the measured points.
Rate	0 to 100 [50]	Specify the ratio [%] of the points to exclude as noise.

- 3 Set each item in the *Parameter* area.

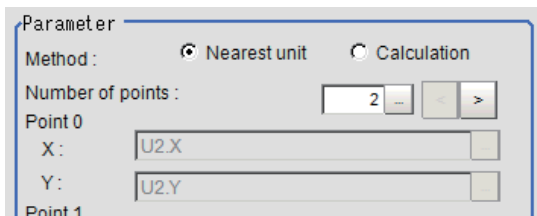

Setting item	Setting value [Factory default]	Description
Method	<ul style="list-style-type: none"> [Nearest unit] Calculation 	<ul style="list-style-type: none"> Nearest unit: Calculated from data of multiple consecutive coordinate measurement processing units just before this processing unit performed. The number of units to reference is set by the <i>Number of points</i>. When units not to measure coordinates are included in the Nearest unit, the calculation is not performed correctly, therefore the measurement result will be NG. Calculation: Calculated from the calculation expression set up. For details, refer to <i>When Calculation is Selected</i> on page 4-24.
Number of points	2 to 8 [2]	Sets the number of coordinate points used for calculation.

4 Click **OK**.

When Calculation is Selected

- Click  at the right of the input text box to set the calculation expression. The *Setting expression* dialog is displayed. For details, refer to 4-3-3 *Layout of Setting Expression Window (Calculation)* on page 4-12.



- After setting up the expression, click **OK**. The expression is confirmed.

4-4-3 Line 1 (Line Regression)

Line 1 is only enabled when *Calculate cross point and angle of two lines* is selected in the Select function.

- The set up method is the same as **Line 0**.
For details, refer to 4-4-2 *Line 0 (Line Regression)* on page 4-23.

4-4-4 Point (Line Regression)

Point is only enabled when *Calculate distance between line and point* is selected in *Select function*.

- In the Item Tab area, click **Point**.
- Click  at the right of the input text box to set the calculation expression. The *Setting expression* dialog is displayed.

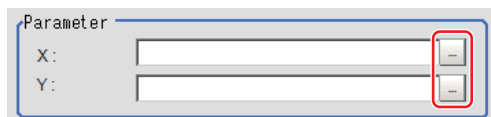

- 3** After setting up the expression, click **OK**.
The expression is confirmed.

4-4-5 Key Points for Test Measurement and Adjustment (Line Regression)

The following content is displayed in the *Detail result* area as text.

Displayed item	Description
Judge	Judgment results 0: No judgment (unmeasured) 1: Judgment result OK -1: Judgment result NG -10: Error (image format mismatch) -11: Error (unregistered model) -12: Error (insufficient memory) -20: Error (other errors)
Line parameter A	Parameter A of line 0
Line parameter B	Parameter B of line 0
Line parameter C	Parameter C of line 0
Line parameter A1	Parameter A of line 1 (only displayed when calculating the intersection of 2 lines)
Line parameter B1	Parameter B of line 1 (only displayed when calculating the intersection of 2 lines)
Line parameter C1	Parameter C of line 1 (only displayed when calculating the intersection of two lines)
Cross point X	X coordinate of intersection (only displayed when calculating the intersection of two lines or calculating the distance between a line and a point)
Cross point Y	Y coordinate of intersection (only displayed when calculating the intersection of two lines or calculating the distance between a line and a point)
Angle	Angle between two lines (only displayed when calculating the intersection of two lines)
Point X	X coordinate of input point (only displayed when calculating the distance between a line and a point)
Point Y	Y coordinate of input point (only displayed when calculating the distance between a line and a point)
Distance	Distance between line 0 and an input point (only displayed when calculating the distance between a line and a point)

4-4-6 Measurement Results for Which Output Is Possible (Line Regression)

The following values can be output using processing items related to result output. It is also possible to reference measurement values from calculation expressions and other processing units.

Measurement items	Character string	Description
Judge	JG	Judgment results 0: No judgment (unmeasured) 1: Judgment result OK -1: Judgment result NG -10: Error (image format mismatch) -11: Error (unregistered model) -12: Error (insufficient memory) -20: Error (other errors)
Line param. 0	A	Parameter A of line 0
Line param. 0	B	Parameter B of line 0
Line param. 0	C	Parameter C of line 0
Line param. 1	A1	Parameter A of line 1
Line param. 1	B1	Parameter B of line 1
Line param. 1	C1	Parameter C of line 1
Cross point X	CX	X coordinate of intersection
Cross point Y	CY	Y coordinate of intersection
Angle	TH	Angle between two lines
Point X	PX	X coordinate of input point
Point Y	PY	Y coordinate of input point
Distance	DS	Distance between line 0 and input point

4-4-7 External Reference Tables (Line Regression)

No.	Data name	Data ident	Set/Get	Data range
0	Judge	judge	Get only	0: No judgment (unmeasured), 1: Judgment result OK, -1: Judgment result NG, -10: Error (image format mismatch), -11: Error (unregistered model), -12: Error (insufficient memory), -20: Error (other errors)
5	Line Param.0 A	paramA	Get only	-99,999.9999 to 99,999.9999
6	Line Param.0 B	paramB	Get only	-99,999.9999 to 99,999.9999
7	Line Param.0 C	paramC	Get only	-99,999.9999 to 99,999.9999
8	Line Param.1 A	paramA1	Get only	-99,999.9999 to 99,999.9999
9	Line Param.1 B	paramB1	Get only	-99,999.9999 to 99,999.9999
10	Line Param.1 C	paramC1	Get only	-99,999.9999 to 99,999.9999
11	Cross point X	crossX	Get only	-99,999.9999 to 99,999.9999
12	Cross point Y	crossY	Get only	-99,999.9999 to 99,999.9999
13	Angle	angle	Get only	0 to 180
14	Point X	pointX	Get only	-99,999.9999 to 99,999.9999
15	Point Y	pointY	Get only	-99,999.9999 to 99,999.9999
16	Distance	distance	Get only	0 to 99,999.9999
101	Output Coordinates	outputCoordinate	Set/Get	0: After scroll 1: Before scroll
102	Calibration	calibration	Set/Get	0: OFF, 1: ON

No.	Data name	Data ident	Set/Get	Data range
120	Function type	functionType	Set/Get	0: Calculate line, 1: Calculate cross point and angle of two lines, 2: Calculate distance between line and point
121	Noise cancel 0	noiseCancel0	Set/Get	0: Noise cancel OFF 1: Noise cancel ON
122	Noise cancel 1	noiseCancel1	Set/Get	0: Noise cancel OFF 1: Noise cancel ON
123	Number of points 0	pointNum0	Set/Get	2 to 8
124	Number of points 1	pointNum1	Set/Get	2 to 8
125	Method 0	method0	Set/Get	0: Nearest unit, 1: Expression
126	Method 1	method1	Set/Get	0: Nearest unit, 1: Expression
130	Expressions(Line0 Point0 coordinateX)	setupData0	Set/Get	Exp. character string
131	Expressions(Line0 Point0 coordinateY)	setupData1	Set/Get	Exp. character string
:	:	:	:	:
144	Expressions(Line0 Point7 coordinateX)	setupData14	Set/Get	Exp. character string
145	Expressions(Line0 Point7 coordinateY)	setupData15	Set/Get	Exp. character string
146	Expressions(Line1 Point0 coordinateX)	setupData16	Set/Get	Exp. character string
147	Expressions(Line1 Point0 coordinateY)	setupData17	Set/Get	Exp. character string
:	:	:	:	:
160	Expressions(Line1 Point7 coordinateX)	setupData30	Set/Get	Exp. character string
161	Expressions(Line1 Point7 coordinateY)	setupData31	Set/Get	Exp. character string
162	Expressions(Point coordinateX)	setupData32	Set/Get	Exp. character string
163	Expressions(Point coordinateY)	setupData33	Set/Get	Exp. character string
164	Rate0	fncRate0	Set/Get	0 to 100
165	Rate1	fncRate1	Set/Get	0 to 100

4-5 Circle Regression

Calculates the circle that generates the shortest total distance from multiple measurement coordinates (Circle Regression).

Used in the Following Case

This is used when calculating the center and radius of a circle.

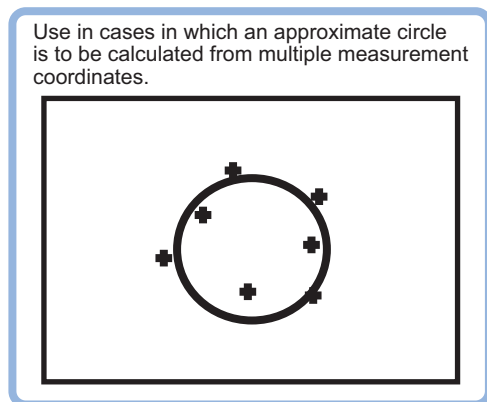

Precautions for Correct Use

Do not set processing units that perform affine transformations such as position correction between Circle Regression and a unit that inputs for Circle Regression.

4-5-1 Parameter Settings (Circle Regression)

1 In the *Parameter* area, set each item.

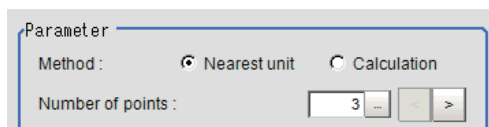

Setting item	Setting value [Factory default]	Description
Method	<ul style="list-style-type: none"> [Nearest unit] Calculation 	<ul style="list-style-type: none"> Nearest unit: Calculated from data of multiple consecutive coordinate measurement processing units just before this processing unit performed. The number of units to reference is set by the <i>Number of points</i>. When units not to measure coordinates are included in the Nearest unit, the calculation is not performed correctly, therefore the measurement result will be NG. Calculation: Calculated from the calculation expression set up. For details, refer to <i>When Calculation is Selected</i> on page 4-24.
Number of points	3 to 8 [3]	Sets the number of coordinate points used for calculation.

2 Click **OK**.

When Calculation is Selected

1 Click  at the right of the input text box to set the calculation expression. The *Setting expression* dialog is displayed.



2 After setting up the expression, click **OK**. The expression is confirmed.

4-5-2 Key Points for Test Measurement and Adjustment (Circle Regression)

The following content is displayed in the *Detail result* area as text.

Displayed item	Description
Judge	Judgment results 0: No judgment (unmeasured) 1: Judgment result OK -1: Judgment result NG -10: Error (image format mismatch) -11: Error (unregistered model) -12: Error (insufficient memory) -20: Error (other errors)
Center coordinate X	Center coordinate X
Center coordinate Y	Center coordinate Y
Radius R	Radius

4-5-3 Measurement Results for Which Output Is Possible (Circle Regression)

The following values can be output using processing items related to result output. It is also possible to reference measurement values from calculation expressions and other processing units.

Measurement items	Character string	Description
Judge	JG	Judgment results 0: No judgment (unmeasured) 1: Judgment result OK -1: Judgment result NG -10: Error (image format mismatch) -11: Error (unregistered model) -12: Error (insufficient memory) -20: Error (other errors)
Center coordinate X	X	Center coordinate X
Center coordinate Y	Y	Center coordinate Y

Measurement items	Character string	Description
Radius	R	Radius

4-5-4 External Reference Tables (Circle Regression)

No.	Data name	Data ident	Set/Get	Data range
0	Judge	judge	Get only	0: No judgment (unmeasured), 1: Judgment result OK, -1: Judgment result NG, -10: Error (image format mismatch), -11: Error (unregistered model), -12: Error (insufficient memory), -20: Error (other errors)
5	Central X	paramX	Get only	-99,999.9999 to 99,999.9999
6	Central Y	paramY	Get only	-99,999.9999 to 99,999.9999
7	Radius	paramR	Get only	0 to 99,999.9999
101	Output Coordinates	outputCoordinate	Set/Get	0: After scroll 1: Before scroll
102	Calibration	calibration	Set/Get	0: OFF, 1: ON
121	Number of points	pointNum	Set/Get	3 to 8
122	Method	method	Set/Get	0: Nearest unit 1: Expression
130	Expressions(Point0 coordinateX)	setupData0	Set/Get	Exp. character string
131	Expressions(Point0 coordinateY)	setupData1	Set/Get	Exp. character string
132	Expressions(Point1 coordinateX)	setupData2	Set/Get	Exp. character string
133	Expressions(Point1 coordinateY)	setupData3	Set/Get	Exp. character string
134	Expressions(Point2 coordinateX)	setupData4	Set/Get	Exp. character string
135	Expressions(Point2 coordinateY)	setupData5	Set/Get	Exp. character string
136	Expressions(Point3 coordinateX)	setupData6	Set/Get	Exp. character string
137	Expressions(Point3 coordinateY)	setupData7	Set/Get	Exp. character string
138	Expressions(Point4 coordinateX)	setupData8	Set/Get	Exp. character string
139	Expressions(Point4 coordinateY)	setupData9	Set/Get	Exp. character string
140	Expressions(Point5 coordinateX)	setupData10	Set/Get	Exp. character string
141	Expressions(Point5 coordinateY)	setupData11	Set/Get	Exp. character string
142	Expressions(Point6 coordinateX)	setupData12	Set/Get	Exp. character string

No.	Data name	Data ident	Set/Get	Data range
143	Expressions(Point6 coordinateY)	setupData13	Set/Get	Exp. character string
144	Expressions(Point7 coordinateX)	setupData14	Set/Get	Exp. character string
145	Expressions(Point7 coordinateY)	setupData15	Set/Get	Exp. character string

4-6 Precise Calibration

This processing item corrects for camera tilt, and also corrects image distortion caused by the camera lens. Moreover, by setting the calibration, the measurement result can be converted and output as actual dimensions.

This processing item also generates a calibration parameter that corrects the X and Y coordinates. However, there is no correction for angle, area, line, and distance.

Make sure to set five or more actual coordinates when you perform this processing item.

Although calibration is also available in Camera Image Input, the calibration data from just prior to the unit referencing calibration data becomes effective.

Used in the Following Case

- Processing trapezoidal images obliquely imaged to make them easier for inspection
- Processing images with lens distortion to make them easier for inspection
- Applying calibration settings for images with lens distortion and/or trapezoidal distortion

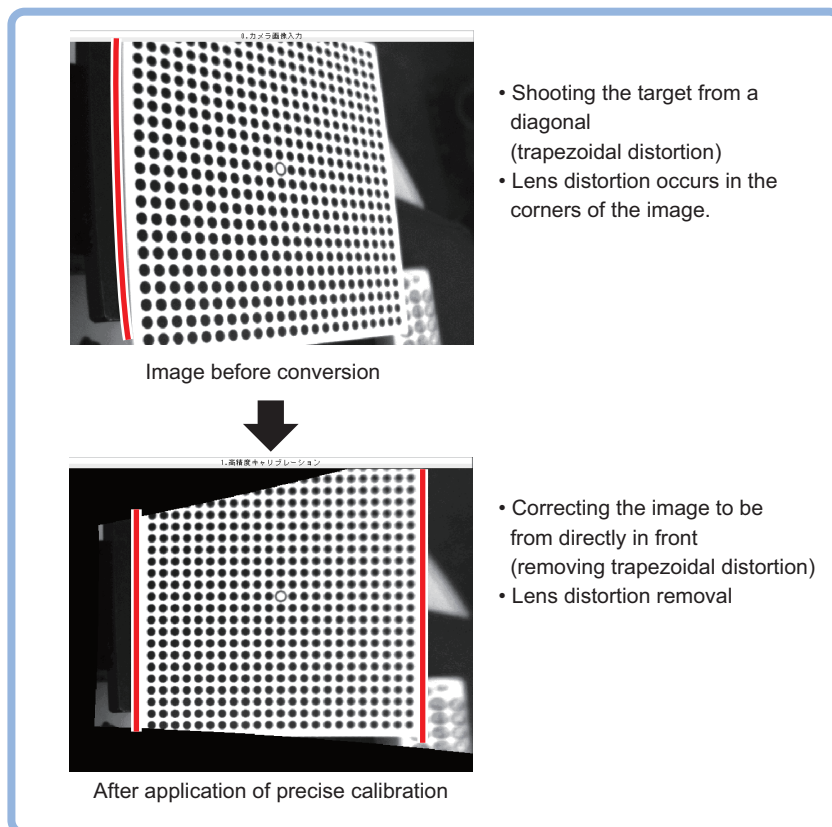



Additional Information

A square-matrix calibration plate pattern (Pattern) printed by the Calibration Plate Print Tool (refer to the *Calibration Plate Print Tool* in the *Vision Sensor FH Series Operation Manual for Sysmac Studio (Cat. No. Z43)*) can be used in this processing item. The accuracy of the calibration will be affected by the accuracy of the Calibration Plate. When the Pattern is printed on paper, the quality of the paper and/or degree of print jitter also affects the accuracy of the calibration.

When sub-pixel level accuracy is required, use OMRON pattern plate (FZD-CAL 3D Calibration Tool).



Precautions for Correct Use

- When this processing item is applied to images to which other processing items are also being applied, the correction may not be done correctly. Always apply this processing item immediately after image input from the camera.
- Make sure that the points taught for calibration are evenly distributed on the screen. If not, the correction may not be done correctly.
- In the measurement flow, if the processing unit that generates the calibration data is set after the processing unit that corrects the image, the output coordinates that can be acquired by the processing unit after the processing unit that generates the calibration data are only the coordinates after image correction.
- About limits on the number of precise calibration used
In the case of the FH/FHV series, the number of precise calibration processing items that can be used in the same scene group is not limited and can be registered as long as there is sufficient free memory. If the amount of used memory increases and the amount of free memory becomes insufficient, it may cause errors in operation mode switching or in adding processing units into the measurement flow. Please check the memory consumption while creating scenes.

4-6-1 Calibration (Precise Calibration)

Set the input image conversion method (calibration parameters). This only calculates parameters to be used for calibration. The actual compensations is performed in the image correction tab.

Setting with the Pattern Plate

The parameters are automatically calculated by imaging the Omron pattern plate (FZD-CAL 3D Calibration tool).

- 1 In the Item tab area, click **Calibration settings**.
- 2 In the *Calibration method* area, select *Plate input*.

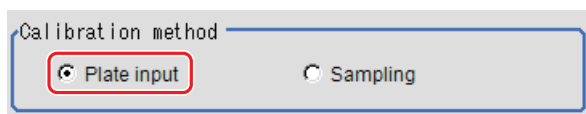

Setting item	Setting value [Factory default]	Description
Calibration method	<ul style="list-style-type: none"> • [Plate input] • Sampling 	Selects the calibration parameter setting method.

- 3** In the *Display* area, click **Change display** to switch between camera image types. The displayed contents of the *Image display* area will be switched.

Setting item	Setting value [Factory default]	Description
Display	<ul style="list-style-type: none"> Through image [Freeze image] 	<ul style="list-style-type: none"> Through image: The latest image is always loaded from the camera and displayed. Freeze image: The image loaded in the immediately preceding measurement is displayed.

- 4** Image the pattern plate and set each item.

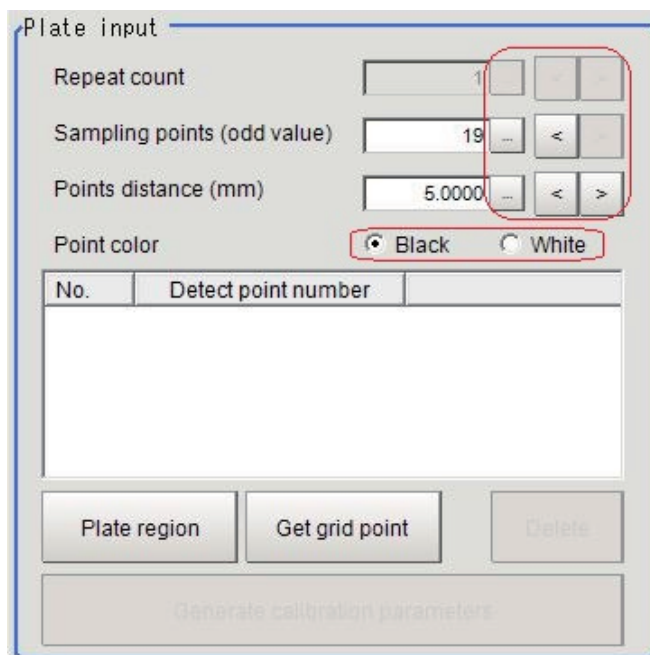

Setting item	Setting value [Factory default]	Description
Repeat count	1 to 10 [1]	Imaging the plate multiple times stably detects grid points even when images with noise is large. Sets the number of repetitions.
Sampling points	5 to 19 [19]	Sets the point string count for the pattern plate.
Points distance	1.0000 to 1,000.0000 [5.0000]	Sets the point interval for the pattern plate. Unit: mm
Point color	<ul style="list-style-type: none"> [Black] White 	Specify the color of the circle marks on the pattern plate.

- 5** Set the plate region as necessary. The initial value has been set to the entire screen.



Additional Information

- Extracting grid points may fail if anything other than the pattern plate were displayed on the image.
In this case, specify the plate region.
- Extracting grid points may fail if the circle marks on the pattern plate were incomplete or unclear.
In this case, exclude the corresponding circle marks from the plate region.
- Extracting grid points may fail if the brightness difference between white and black regions on the pattern plate is small or there is unevenness in brightness.
In this case, adjust lighting and/or camera conditions.

Click **Plate region**.

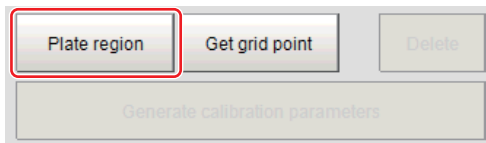

Use the drawing tools to specify the pattern plate range.

Click **OK** in the *Figure setting* area.

- **OK**: Changes the settings and returns to the previous menu.
- **Cancel**: Changes are discarded and returns to the previous menu.
- **Apply**: Updates the settings without leaving the current window.

The pattern platerange is registered.

6 Click **Get grid point**.

The grid points extracted are listed on the *Plate input* area.

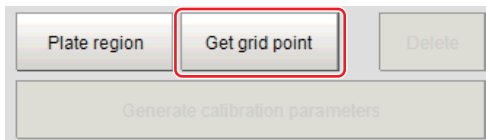

Additional Information

The grid points are extracted multiple times by shifting the plate when the plate is small compared to the field of view. By selecting Through image and repeating step 4 to 6, the information can be obtained from the plates located on different positions.

7 Delete grid points as necessary.



Precautions for Correct Use

- After generating calibration parameters, if deleting grid points or changing the settings, the calibration parameters are deleted. In this case, calibration parameters need to be re-generated.
- The deleted grid points are deleted from the list.

Specify the grid points to delete from the list. Click **Delete**.

Plate input

Repeat count

Sampling points (odd value)

Points distance (mm)

No.	Defect point number
0	(361)

Plate region Get grid point Delete

- 8** Click **Generate calibration parameters**.

Plate region Get grid point Delete

Generate calibration parameters

The calibration parameters are generated.

Calibration status

Calibration parameters have been updated

Precision error	X max. (mm)	0.0973
	Y max. (mm)	0.0463

Setting Calibration through Sampling Measurement (Sampling)

This is a method for setting calibration based on measurement results.

Calibration parameters are automatically calculated by searching a registered model and setting the actual coordinates for the model position.

For the actual coordinates settings, set as two or more straight lines forming straight lines parallel for the X-coordinate and Y-coordinate.

And set each straight line formed with three or more points.

- 1** In the Item tab area, click **Calibration settings**.
- 2** In the *Calibration method* area, select *Sampling*.

Calibration method

Plate input Sampling

- 3** In the *Sampling* area, click **Register model**.

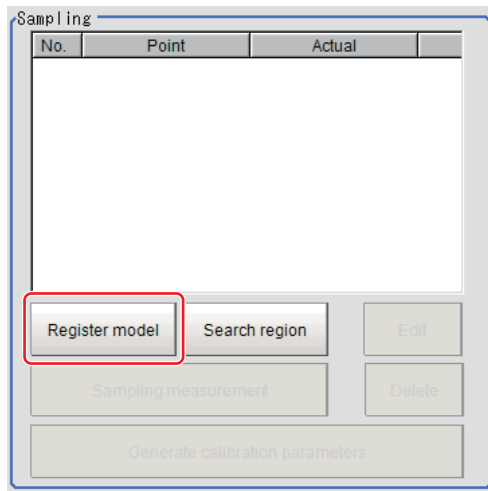

4 Use the Drawing tools to register the model.

5 Adjust the search region as necessary.
The initial value has been set for the entire screen.

Click **Search region**.

Specify the measurement region with the Drawing tools.

Click **OK** in the *Figure setting* area.

- **OK**: Changes the settings and returns to the previous menu.
- **Cancel**: Changes are discarded and returns to the previous menu.
- **Apply**: Updates the settings without leaving the current window.

The target area for filtering is registered.

6 Click **Sampling measurement**.

The measurement is performed.

The search result (crosshair cursor) is displayed in the *Image display* area and the *Sampling coordinate input* window is displayed.

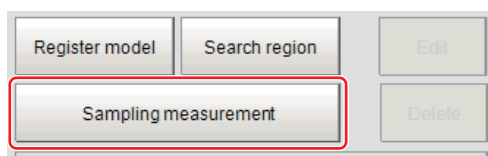

7 In the *Sampling coordinate input* window, set X and Y coordinates.

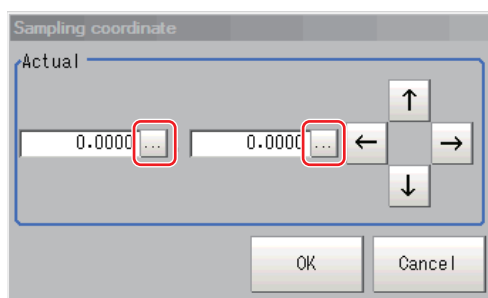

8 Click **OK**.

The point coordinates and the actual coordinates are registered in the *Sampling* area.

9 Move the measurement object and repeat step 3 to 8.

10 Edit or delete coordinates as necessary.



Precautions for Correct Use

- Editing or deleting coordinates after generating calibration parameters updates them.
- The deleted coordinate are deleted from the list.

Set grid points to edit or delete on the list.

Click **Edit** or **Delete**.

Perform the step 7 when clicking **Edit**.

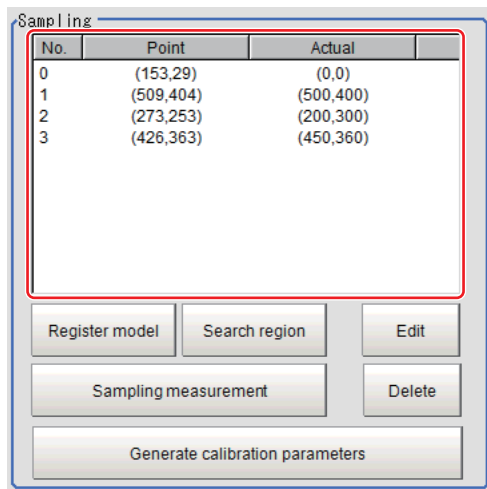

11 Click **Generate calibration parameters**.

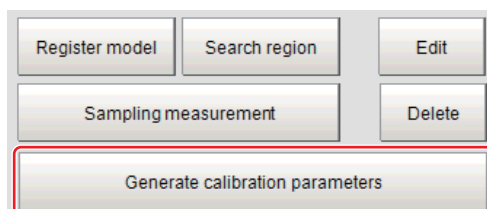

The calibration parameters will be generated.

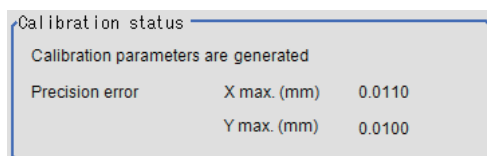

Additional Information

- If the precision for the input grid points were poor, generating parameters may fail. In this case, adjust again so that the grid points are clearly viewed.
- The accuracy evaluation values are just a estimation for calibration and the actual precision is not guaranteed.

4-6-2 Height Adjustment (Precise Calibration)

Even if the plane height is different at calibration and measurement, adjust so that the correct coordinates can be corrected.



Precautions for Correct Use

- The height adjustment is only valid when the camera faces the measurement object in parallel. If the camera is tilted, the correction may not be correctly performed.
- The results of height adjustment are not applied to image correction.

1 In the Item tab area, click **Height adjustment**.

2 In the *Height adjustment* area, select **ON**.

3 Input the numerical values in the *Camera lens adjustment* area.

Setting item	Setting value [Factory default]	Description
Focal length	3.0000 to 200.0000 [16.0000]	Sets the focal distance of the camera used for imaging in mm.
CCD pixel width	1.0000 to 15.0000 [4.7000]	Sets the camera pixel size in μm .

4 Input the numerical values in the *Plate adjustment* area.

Setting item	Setting value [Factory default]	Description
Plate height	-100.0000 to 100.0000 [0.0000]	Sets the plate height in mm.
Workpiece height	-100.0000 to 100.0000 [0.0000]	Sets the measurement object height in mm.



Precautions for Correct Use

The plate settings set the height from the reference surface for placing a workpiece. Sets the plate height from the reference surface and the workpiece height.

4-6-3 Image Correction (Precise Calibration)

This performs actual image correction based on the parameters generated with the **Calibration settings** tab.

- 1 In the Item tab area, click **Image correction**.
- 2 In the *Correction settings* area, select **ON**.
When the calibration parameters have already generated, the corrected image is displayed according to the settings.



Precautions for Correct Use

- If the grid points are unevenly distributed at the parameter generation, images may not properly corrected.
- When setting ON to the image correction function, X and Y on the *Sampling coordinate* input window are only supported with the left-hand coordinate system. If inputting X and Y with the right-hand coordinate system, images are not properly converted.

4-6-4 Measurement Results for Which Output Is Possible (Precise Calibration)

The following values can be output using processing items related to result output. It is also possible to reference measurement values from calculation expressions and other processing units.

Measurement items	Character string	Description
Judge	JG	Judgment results 0: No judgment (unmeasured) 1: Judgment result OK -1: Judgment result NG -10: Error (image format mismatch) -11: Error (unregistered model) -12: Error (insufficient memory) -20: Error (other errors)

4-6-5 External Reference Tables (Precise Calibration)

No.	Data name	Data ident	Set/Get	Data range
0	Judge	judge	Get only	0: No judgment (unmeasured), 1: Judgment result OK, -1: Judgment result NG, -10: Error (image format mismatch), -11: Error (unregistered model), -12: Error (insufficient memory), -20: Error (other errors)
103	Reflect to overall judgement	overallJudge	Set/Get	0: ON, 1: OFF
120	Calibration method	settingMethod	Set/Get	0: Sampling 1: Pattern board
121	Correction setting	correctSetting	Set/Get	0: Not display filtered image, 1: Display filtered image
180	Row count (odd value)	col	Set/Get	5 to 19
181	Column count (odd value)	row	Set/Get	5 to 19
182	Points distance (mm)	interval	Set/Get	1 to 1,000
183	Repeat count	loop	Set/Get	1 to 10
184	Point color	pointColor	Set/Get	0: Black, 1: White
240	Lens focus[mm]	physical_focus	Set/Get	3 to 200
241	CCD1 pixel size[um]	ccd_pix_size	Set/Get	1 to 15
242	Plate height[mm]	plate_Height	Set/Get	-100 to 100
243	Work height[mm]	work_Height	Set/Get	-100 to 100
244	Depth setting	useDepth	Set/Get	0: OFF, 1: ON
260	Error/Max. X	maxX	Get only	-1 to 1
261	Error/Max. Y	maxY	Get only	-1 to 1
6,002	Format	cameraColor	Set/Get	1: Monochrome camera 2: Color camera

4-7 User Data

This processing item is not available in the FHV series.

User data is data that can be shared by scenes in the Sensor Controller. User data values are stored as system data, and the same user data can be accessed from different scenes. User data processing items can be used to set and get user data. When you want to set default values or comments in user data, use the User Data Tool in addition to the user data processing items.

For details, refer to *Sharing Data Within the Controller [User Data Tool]* in the *Vision System FH/FHV Series User's Manual (Cat. No. Z365)*.

Used in the Following Case

When sharing arbitrarily set data among other multiple processing units:

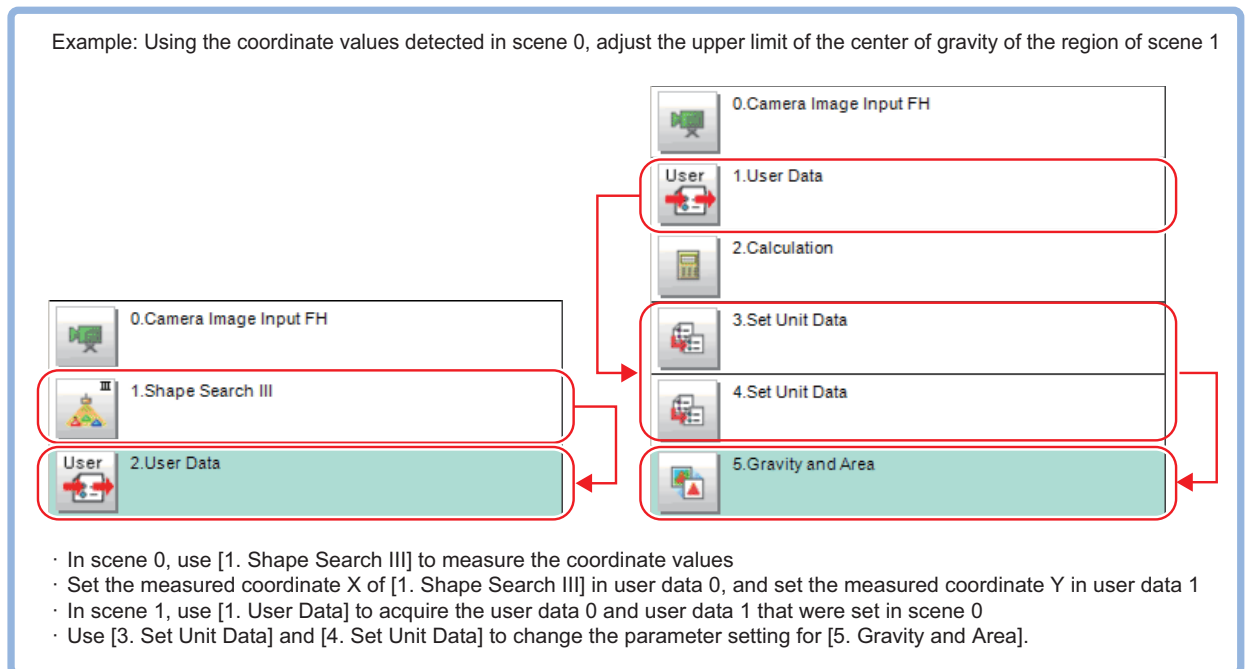

4-7-1 Settings Flow (User Data)

To set User Data, follow the steps below.

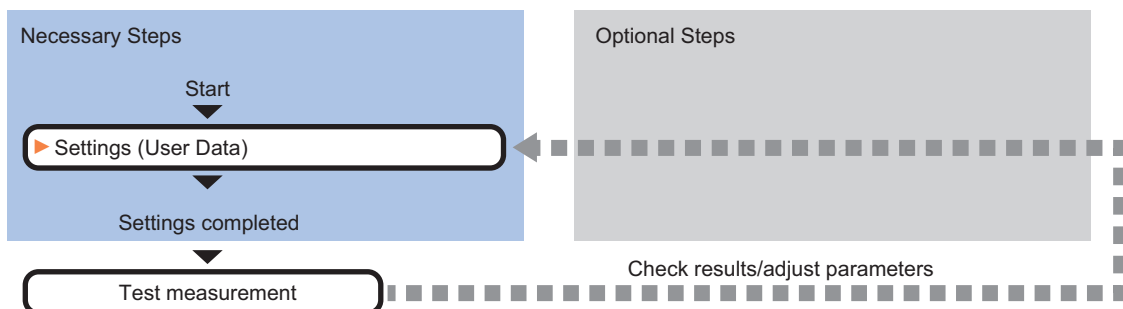

List of User Data Items

In User Data, the following items can be set up.

Item	Description
Setting	Sets calculation expressions and values to be set as user data. The number of user data is up to 100. 4-7-2 Settings (User Data) on page 4-43

4-7-2 Settings (User Data)

Set the values and calculation expressions to be set as user data. The number of user data is up to 100.

- 1 In the Item Tab area, click **Setting**.
- 2 In the *User data list* area, select a calculation expression to set user data.

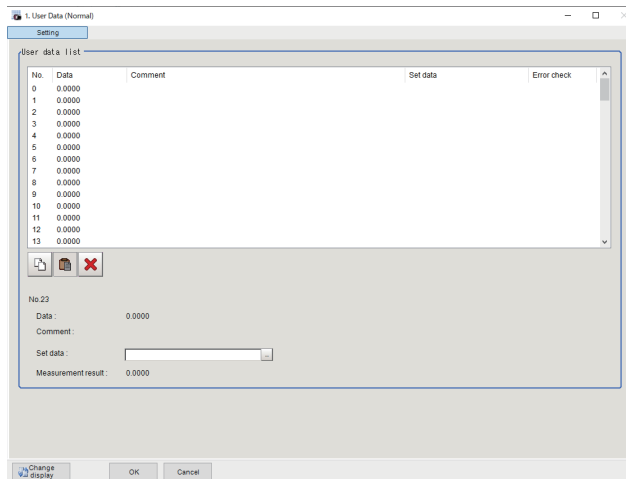

- 3 In the *User data list* area, click  at the right end of the Set data text box.
- 4 Set the calculation expression.
- 5 After setting up the expression, click **OK**.
The expression is confirmed.



Additional Information

- If the calculation expression for the setting data is invalid at opening the *Setting* window, an error message, *Setting error in the set data*, is displayed. In this case, the error symbol *E* is also displayed in the error check field. Correct the calculation expression that *E* is displayed. The error message will not disappear until there are no *E* symbol.
- When no calculation expression is set to the setting data, the values of user data themselves can be acquired as the measurement results. When calculation expressions are set, the values of user data that the calculation results were reflected are acquired.

4-7-3 Key Points for Test Measurement and Adjustment (User Data)

The following content is displayed in the *Detail result* area as text.



Precautions for Correct Use

When test measurement is performed, the detailed display and image display are updated according to the measurement results.

Displayed item	Description
Judge	Judgment results 0: No judgment (unmeasured) 1: Judgment result OK -1: Judgment result NG -10: Error (image format mismatch) -11: Error (unregistered model) -12: Error (insufficient memory) -20: Error (other errors)

The image specified in the Sub-image number in the image display setting is displayed in the *Image Display* area.

Sub-image number	Description of image to be displayed
0	Measurement image

4-7-4 Measurement Results For Which Output Is Possible (User Data)

The following values can be output using processing items related to result output. It is also possible to reference measurement values from calculation expressions and other processing units.

Measurement items	Character string	Description
Judge	JG	Judgment results 0: No judgment (unmeasured) 1: Judgment result OK -1: Judgment result NG -10: Error (image format mismatch) -11: Error (unregistered model) -12: Error (insufficient memory) -20: Error (other errors)
Setting data 00 to 99	DT00 to 99	Values of User data 00 to 99



Additional Information

When you do not set a calculation expression to the setting data, the raw values of the corresponding user data can be got as the measurement results. When you set a calculation expression, the user values with the calculation results reflected can be got.

4-7-5 External Reference Tables (Set User Data)

No.	Data name	Data ident	Set/Get	Data range
0	Judge	judge	Get only	0: No judgment (unmeasured), 1: Judgment result OK, -1: Judgment result NG, -10: Error (image format mismatch), -11: Error (unregistered model), -12: Error (insufficient memory), -20: Error (other errors)
200+N (N=0 to 99)	Data	setupData00 to setupData99	Set/Get	Exp. character string
1,000+N (N=0 to 99)	Calculation result	resultData00 to resultData99	Get only	-999,999,999.9999 to 999,999,999.9999

4-8 Set Unit Data

This processing item is not available in the FHV series.

Changes the parameters for processing performed hereafter in the measurement flow.

Used in the Following Case

When rewriting data for a processing unit during measurement

Example) Adjust the search range based on the size of measurement object.

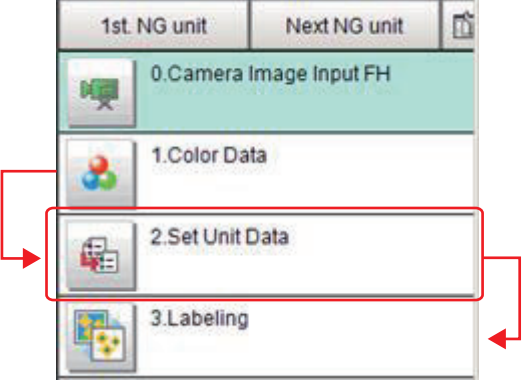

- Measure average density of measurement objects with [1. Color average/differential].
- Adjust lower limit of Binary level for [3. Labeling] based on the above measurement results (monochrome camera only).

Substrate average density value

Use the average density value + difference as the binary level lower limit (monochrome camera only)

4-8-1 Parameter Settings (Set Unit Data)

Data for multiple processing units in the measurement flow is changed to the set data.



Precautions for Correct Use

- Only numerical data is available to be set in the processing unit data setting.
- Use macro customizing function or variable function when setting character string data.
- In the data range in the data list, expressed as ***** Character String**, or ***** Characters** becomes character string data.

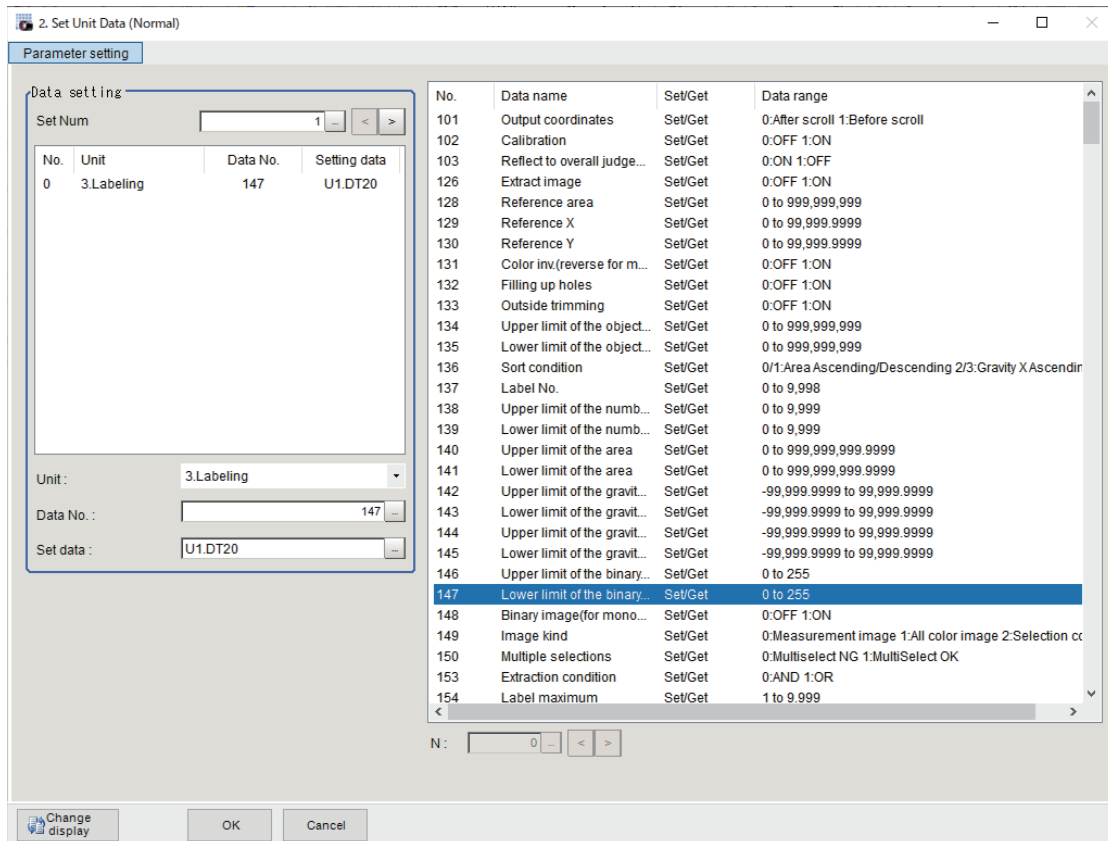

- 1 In the *Data setting* area, specify **Set Num** for data to change.
Up to 16 can be set in **Set Num**. The number of display data follows **Set Num** increase or decrease.



Precautions for Correct Use

For items hidden by increasing or decreasing the **Set Num**, the data setting for processing units are not performed. The set data however is maintained. Therefore, those displayed again by increasing **Set Num**, the maintained data will be displayed. Check the data contents.

Data displayed in the *Data setting* area is No. (data), Unit (target), D and No. (target), and Setting data.

- 2 In the *Data setting* area, click **No.**
- 3 In the *Unit*, select the processing unit to change.
The data list display will be changed by the selection.
Data to be displayed in the data list will be external reference data No., data name, set/get, and data range. Moreover, the displayed data depends on processing items.
For details, refer to *External Reference Data* for each processing item.
- 4 By clicking a row displayed in the data list, set the target data number to write.
Alternatively, click  at the right end of the *Data No.* text box and input the target data number.
The data number depends on processing units.
For details, refer to *External Reference Data* for each processing item.

- 5** In *Data setting*, set the data to rewrite with a calculation expression.
For details, refer to *4-3-3 Layout of Setting Expression Window (Calculation)* on page 4-12.
- 6** Click **OK**.
The settings are completed.

4-8-2 Key Points for Test Measurement and Adjustment (Set Unit Data)

The following content is displayed in the *Detail result* area as text.

Values set in the **Set Num** for the *Unit* 0 to 15, *Data No.* 0 to 15, and *Setting data* 0 to 15 are displayed.

Displayed item	Description
Judge	Judgment results 0: No judgment (unmeasured) 1: Judgment result OK -1: Judgment result NG -10: Error (image format mismatch) -11: Error (unregistered model) -12: Error (insufficient memory) -20: Error (other errors)
Processing unit 0 to 15	Target unit number for data No. 0 to 15
Data No. 0 to 15	Target data number of target unit for data No. 0 to 15
Setting data 0 to 15	Calculation result of setup data (formula) for data No. 0 to 15

4-8-3 Measurement Results for Which Output Is Possible (Set Unit Data)

The following values can be output using processing items related to result output. It is also possible to reference measurement values from calculation expressions and other processing units.

Measurement items	Character string	Description
Judge	JG	Judgment results 0: No judgment (unmeasured) 1: Judgment result OK -1: Judgment result NG -10: Error (image format mismatch) -11: Error (unregistered model) -12: Error (insufficient memory) -20: Error (other errors)
Setting data 0 to 15	DT0 to 15	Calculation results of setting data (formula) for data No. 0 to 15

4-8-4 External Reference Tables (Set Unit Data)

No.	Data name	Data ident	Set/Get	Data range
0	Judge	judge	Get only	00: No judgment (unmeasured), 1: Judgment result OK, -1: Judgment result NG, -10: Error (image format mismatch), -11: Error (unregistered model), -12: Error (insufficient memory), -20: Error (other errors)
5+N (N=0 to 15)	Data	resultData00 to resultData15	Get only	-999,999,999.9999 to 999,999,999.9999
220	Set Num	setNum	Set/Get	1 to 16
321+N (N=0 to 15)	Unit	targetUnitNo00 to targetUnitNo15	Set/Get	0 to 9,999
421+N (N=0 to 15)	Data No.	targetDataNo00 to targetDataNo15	Set/Get	0 to 99,999
521+N (N=0 to 15)	Expressions of setting data	setupData00 to setupData15	Set/Get	Exp. character string

4-9 Get Unit Data

This processing item is not available in the FHV series.

Used in the Following Case



When getting processing unit data during measurement

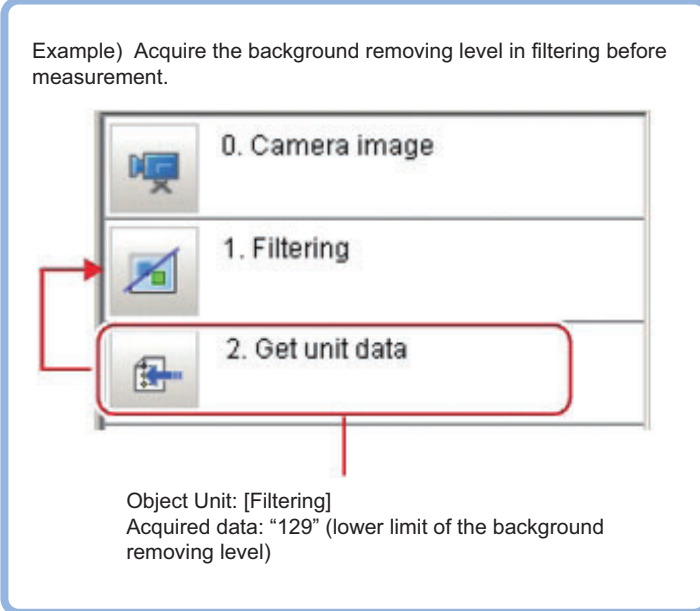

Example) Acquire the background removing level in filtering before measurement.



Object Unit: [Filtering]
Acquired data: "129" (lower limit of the background removing level)

4-9-1 Parameter Settings (Get Unit Data)

- 1 In the *Data setting* area, click  or  of the **Get data number** and set the number of data to be targeted.
The data number, data name, and data range that is available in the target unit will be displayed on the right side.

Get data number :   

No.	Scene	Unit	Data No.
0	Current scene	0.Camera Image L...	0

- 2 From the list, click *No.* to set the getting target.
The No. selected will be displayed on the list.

No.	Scene	Unit	Data No.
0	Current scene	0.Camera Image L...	0
1	Current scene	0.Camera Image L...	0
2	Current scene	0.Camera Image L...	0

- 3** Click ▼ at the right side of the *Scene* and specify the scene number for desired processing unit.

For details, refer to *External Reference Data* for each processing item.

Scene : ▼

Unit : ▼

Data No. : ...

- 4** Click ▼ at the right side of the *Unit* and specify the desired processing unit.

- 5** Click ... at the right side of the *Data No.* and specify the desired data number.
The assignment for the data number depends on processing items.
For details, refer to *External Reference Data* for each processing item.



Precautions for Correct Use

- Only numerical data is available to get in the processing unit data setting.
- Use macro customizing function when getting character string data.
- In the data range in the external reference data list, expressed as **** Character String or *** Characters* becomes character string data.



Additional Information

- Clicking the desired data on the list enters the *Data No.* at the clicked position.

N: ... < >

- When clicking > of **N**, *Data No.* with the N value of the number taken into account will be set.

- 6** Click **OK**.
The settings are completed.

4-9-2 Measurement Results for Which Output Is Possible (Get Unit Data)

The following values can be output using processing items related to result output. It is also possible to reference measurement values from calculation expressions and other processing units.

Measurement items	Character string	Description
Judge	JG	Judgment results 0: No judgment (unmeasured) 1: Judgment result OK -1: Judgment result NG -10: Error (image format mismatch) -11: Error (unregistered model) -12: Error (insufficient memory) -20: Error (other errors)
Data 0 to 15	DT0 to 15	Values of acquired data 0 to 15

4-9-3 External Reference Tables (Get Unit Data)

No.	Data name	Data ident	Set/Get	Data range
0	Judge	judge	Get only	0: No judgment (unmeasured), 1: Judgment result OK, -1: Judgment result NG, -10: Error (image format mismatch), -11: Error (unregistered model), -12: Error (insufficient memory), -20: Error (other errors)
5+N (N=0 to 15)	Data	getData00 to getData15	Get only	-999,999,999.9999 to 999,999,999.9999
220	Get data number	GetNum	Set/Get	1 to 16
221+N (N=0 to 15)	Scene	targetSceneNo00 to targetSceneNo15	Set/Get	-1 to 9,999
321+N (N=0 to 15)	Unit	targetUnitNo00 to targetUnitNo15	Set/Get	0 to 9,999
421+N (N=0 to 15)	Data No.	targetDataNo00 to targetDataNo15	Set/Get	0 to 99,999

4-10 Set Unit Figure

This processing item is not available in the FHV series.

Used in the Following Case

When changing the measurement region according to the measurement results

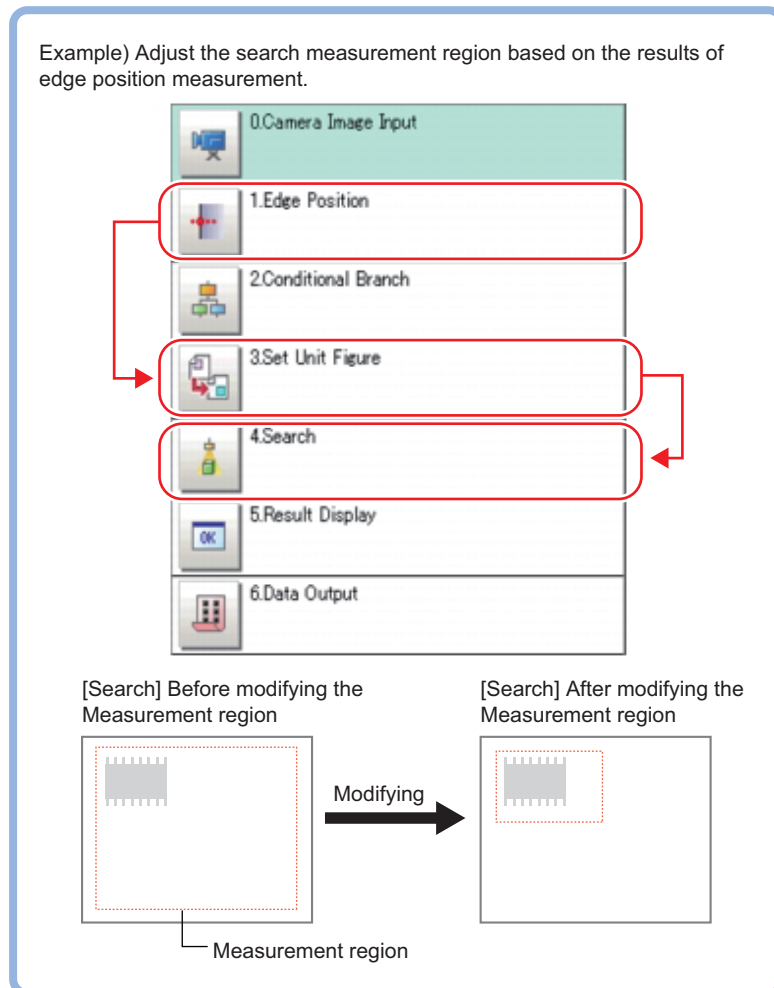

Precautions for Correct Use

Make sure not to insert processing items of *Input Image* and *Compensate Image* between the **Set Unit Figure** target processing unit. The processing unit target figure can disappear. For details, refer to *Section 1 Input Image* on page 1-1 and *Section 3 Compensate Image* on page 3-1.

4-10-1 Parameter Settings (Set Unit Figure)

Up to eight figures are possible to set by this processing unit.

When setting multiple figures for one target unit, set different registration figure numbers.

- 1 Click the target unit in the *Setting target data* area, place a check in the *No.* checkbox.

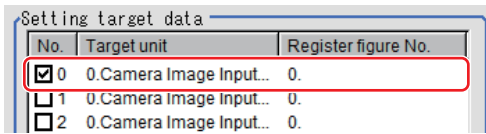

- 2 In the *Data setting* area, click ▼ at the right side of the *Target unit* to select the target unit. The target unit name in the *Setting target data* area is also automatically reflected.

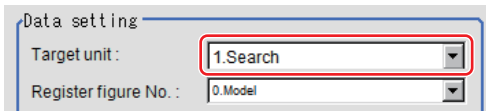

- 3 In the *Data setting* area, click ▼ at the right side of the *Register figure No.* to select the figure to register.

Target figures included in the selected figure are displayed.

The registered figure name in the *Setting target data* area is also automatically reflected.

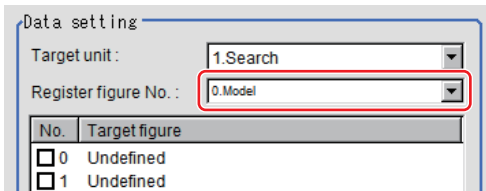

- 4 Click the desired target figure for data setting and place a check in the *No.* checkbox.

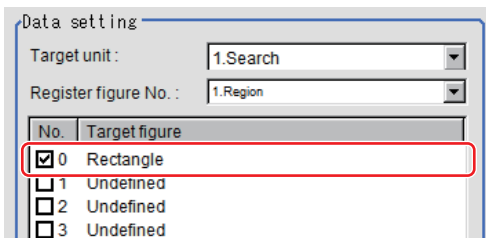

- 5 Click the data name in the *Data name* to rewrite.

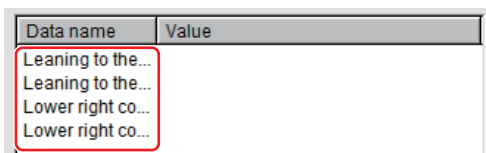

- 6 Click **Edit** and set the contents to rewrite with a calculation expression. For details, refer to 4-3-3 *Layout of Setting Expression Window (Calculation)* on page 4-12.

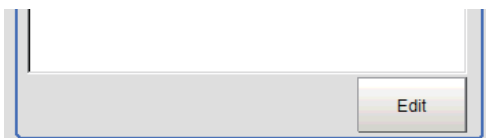

- 7 Click **OK**.

A region is displayed on the image according to the settings.

4-10-2 Key Points for Test Measurement and Adjustment (Set Unit Figure)

The following content is displayed in the *Detail result* area as text.

Displayed item	Description
Judge	Judgment results
Setting target data 0	0: No judgment (unmeasured)
Setting target data 1	1: Judgment result OK
Setting target data 2	-1: Judgment result NG
Setting target data 3	-10: Error (image format mismatch)
Setting target data 4	-11: Error (unregistered model)
Setting target data 5	-12: Error (insufficient memory)
Setting target data 6	-20: Error (other errors)
Setting target data 7	

Judgement becomes NG

Parameter to be adjusted	Remedy
Setting parameters for figures	<ul style="list-style-type: none"> Check if the values entered for the setting figure are correct. If the setting figure is a rectangle, check that coordinates are specified in the order from top-left (X, Y) to bottom-right (X, Y). To refer to the measurement coordinates X and Y from other units, the set order may be the top-right coordinates (X, Y) to bottom-left coordinates (X, Y). If the setting figure is a circle, check that no negative value is specified as the radius. Check that anything other than images are not included in the set figure. Check that figure size limit of the setting target is not exceeded.

4-10-3 Measurement Results for Which Output Is Possible (Set Unit Figure)

The following values can be output using processing items related to result output. It is also possible to reference measurement values from calculation expressions and other processing units.

Measurement items	Character string	Description
Judge	JG	Judgment results 0: No judgment (unmeasured) 1: Judgment result OK -1: Judgment result NG -10: Error (image format mismatch) -11: Error (unregistered model) -12: Error (insufficient memory) -20: Error (other errors)
No. of data items	DNO	Number of set data items
Data 0	DT0	Calculation result of set data 0
Data 1	DT1	Calculation result of set data 1
Data 2	DT2	Calculation result of set data 2
Data 3	DT3	Calculation result of set data 3

Measurement items	Character string	Description
Data 4	DT4	Calculation result of set data 4
Data 5	DT5	Calculation result of set data 5
Data 6	DT6	Calculation result of set data 6
Data 7	DT7	Calculation result of set data 7
Data 8	DT8	Calculation result of set data 8
Data 9	DT9	Calculation result of set data 9
Data 10	DT10	Calculation result of set data 10
Data 11	DT11	Calculation result of set data 11
Data 12	DT12	Calculation result of set data 12
Data 13	DT13	Calculation result of set data 13
Data 14	DT14	Calculation result of set data 14
Data 15	DT15	Calculation result of set data 15
Data 16	DT16	Calculation result of set data 16
Data 17	DT17	Calculation result of set data 17
Data 18	DT18	Calculation result of set data 18
Data 19	DT19	Calculation result of set data 19

4-10-4 External Reference Tables (Set Unit Figure)

No.	Data name	Data ident	Set/Get	Data range
0	Judge	judge	Get only	0: No judgment (unmeasured), 1: Judgment result OK, -1: Judgment result NG, -10: Error (image format mismatch), -11: Error (unregistered model), -12: Error (insufficient memory), -20: Error (other errors)
25	First flag target unit's first flag target figure's Number of setting data items	DNO	Get only	0 to 20
100+N×10 (N=0 to 7)	Flag of target unit	targetUnitCheck_0 to targetUnitCheck_7	Set/Get	0: OFF, 1: ON
101+N×10 (N=0 to 7)	Target unit No.	targetUnitNo_0 to targetUnitNo_7	Set/Get	0 to 9,999
102+N×10 (N=0 to 7)	Target figure No.	registFigureNo_0 to registFigureNo_7	Set/Get	0 to 1,000
200	Flag of target unit 0's target figure0	figureCheck00	Set/Get	0: OFF, 1: ON
201	Flag of target unit 0's target figure1	figureCheck01	Set/Get	0: OFF, 1: ON
202	Flag of target unit 0's target figure2	figureCheck02	Set/Get	0: OFF, 1: ON
203	Flag of target unit 0's target figure3	figureCheck03	Set/Get	0: OFF, 1: ON
204	Flag of target unit 0's target figure4	figureCheck04	Set/Get	0: OFF, 1: ON

No.	Data name	Data ident	Set/Get	Data range
205	Flag of target unit 0's target figure5	figureCheck05	Set/Get	0: OFF, 1: ON
206	Flag of target unit 0's target figure6	figureCheck06	Set/Get	0: OFF, 1: ON
207	Flag of target unit 0's target figure7	figureCheck07	Set/Get	0: OFF, 1: ON
210	Flag of target unit 1's target figure 0	figureCheck10	Set/Get	0: OFF, 1: ON
:	:	:	:	:
220	Flag of target unit 2's target figure 0	figureCheck20	Set/Get	0: OFF, 1: ON
:	:	:	:	:
230	Flag of target unit 3's target figure 0	figureCheck30	Set/Get	0: OFF, 1: ON
:	:	:	:	:
240	Flag of target unit 4's target figure 0	figureCheck40	Set/Get	0: OFF, 1: ON
:	:	:	:	:
250	Flag of target unit 5's target figure 0	figureCheck50	Set/Get	0: OFF, 1: ON
:	:	:	:	:
260	Flag of target unit 6's target figure 0	figureCheck60	Set/Get	0: OFF, 1: ON
:	:	:	:	:
270	Flag of target unit 7's target figure 0	figureCheck70	Set/Get	0: OFF, 1: ON
:	:	:	:	:
277	Flag of target unit 7's target figure 7	figureCheck77	Set/Get	0: OFF, 1: ON
300	Now select target unit	unitIndex	Set/Get	0 to 7
303	Current unit Figure No.	targetFigureNo	Set/Get	0 to 7
310+N (N=0 to 7)	Now select target unit's target figure's flag	figureCheck0 to figureCheck7	Set/Get	0: OFF, 1: ON
1,000+N (N=0 to 19)	Target unit0's target figure0's Data	data00_00 to data00_19	Get only	-999,999,999.9999 to 999,999,999.9999
1,100+N (N=0 to 19)	Target unit0's target figure1's Data	data01_00 to data01_19	Get only	-999,999,999.9999 to 999,999,999.9999
1,200+N (N=0 to 19)	Target unit0's target figure2's Data	data02_00 to data02_19	Get only	-999,999,999.9999 to 999,999,999.9999
1,300+N (N=0 to 19)	Target unit0's target figure3's Data	data03_00 to data03_19	Get only	-999,999,999.9999 to 999,999,999.9999
1,400+N (N=0 to 19)	Target unit0's target figure4's Data	data04_00 to data04_19	Get only	-999,999,999.9999 to 999,999,999.9999
1,500+N (N=0 to 19)	Target unit0's target figure5's Data	data05_00 to data05_19	Get only	-999,999,999.9999 to 999,999,999.9999
1,600+N (N=0 to 19)	Target unit0's target figure6's Data	data06_00 to data06_19	Get only	-999,999,999.9999 to 999,999,999.9999

No.	Data name	Data ident	Set/Get	Data range
1,700+N (N=0 to 19)	Target unit0's target figure7's Data	data07_00 to data07_19	Get only	-999,999,999.9999 to 999,999,999.9999
2,000+N (N=0 to 19)	Target unit1's target figure0's Data	data10_00 to data10_19	Get only	-999,999,999.9999 to 999,999,999.9999
:	:	:	:	:
3,000+N (N=0 to 19)	Target unit2's target figure0's Data	data20_00 to data20_19	Get only	-999,999,999.9999 to 999,999,999.9999
:	:	:	:	:
4,000+N (N=0 to 19)	Target unit3's target figure0's Data	data30_00 to data30_19	Get only	-999,999,999.9999 to 999,999,999.9999
:	:	:	:	:
5,000+N (N=0 to 19)	Target unit4's target figure0's Data	data40_00 to data40_19	Get only	-999,999,999.9999 to 999,999,999.9999
:	:	:	:	:
6,000+N (N=0 to 19)	Target unit5's target figure0's Data	data50_00 to data50_19	Get only	-999,999,999.9999 to 999,999,999.9999
:	:	:	:	:
7,000+N (N=0 to 19)	Target unit6's target figure0's Data	data60_00 to data60_19	Get only	-999,999,999.9999 to 999,999,999.9999
:	:	:	:	:
8,000+N (N=0 to 19)	Target unit7's target figure0's Data	data70_00 to data70_19	Get only	-999,999,999.9999 to 999,999,999.9999
:	:	:	:	:
8,700+N (N=0 to 19)	Target unit7's target figure7's Data	data77_00 to data77_19	Get only	-999,999,999.9999 to 999,999,999.9999
10,000+N (N=0 to 19)	Target unit0's target figure0's setting data	setupData00_00 to setupData00_19	Set/Get	Exp. character string
:	:	:	:	:
10,700+N (N=0 to 19)	Target unit0's target figure7's setting data	setupData07_00 to setupData07_19	Set/Get	Exp. character string
11,000+N (N=0 to 19)	Target unit1's target figure0's setting data	setupData10_00 to setupData10_19	Set/Get	Exp. character string
:	:	:	:	:
12,000+N (N=0 to 19)	Target unit2's target figure0's setting data	setupData20_00 to setupData20_19	Set/Get	Exp. character string
:	:	:	:	:
13,000+N (N=0 to 19)	Target unit3's target figure0's setting data	setupData30_00 to setupData30_19	Set/Get	Exp. character string
:	:	:	:	:
14,000+N (N=0 to 19)	Target unit4's target figure0's setting data	setupData40_00 to setupData40_19	Set/Get	Exp. character string
:	:	:	:	:
15,000+N (N=0 to 19)	Target unit5's target figure0's setting data	setupData50_00 to setupData50_19	Set/Get	Exp. character string
:	:	:	:	:
16,000+N (N=0 to 19)	Target unit6's target figure0's setting data	setupData60_00 to setupData60_19	Set/Get	Exp. character string
:	:	:	:	:

No.	Data name	Data ident	Set/Get	Data range
17,000+N (N=0 to 19)	Target unit7's target figure0's setting data	setupData70_00 to setupData70_19	Set/Get	Exp. character string
:	:	:	:	:
17,700+N (N=0 to 19)	Target unit7's target figure7's setting data	setupData77_00 to setupData77_19	Set/Get	Exp. character string

4-11 Get Unit Figure

This processing item is not available in the FHV series.
Gets and displays figures drawn by other processing units.

Used in the Following Case

When acquiring data such as coordinates from figure information

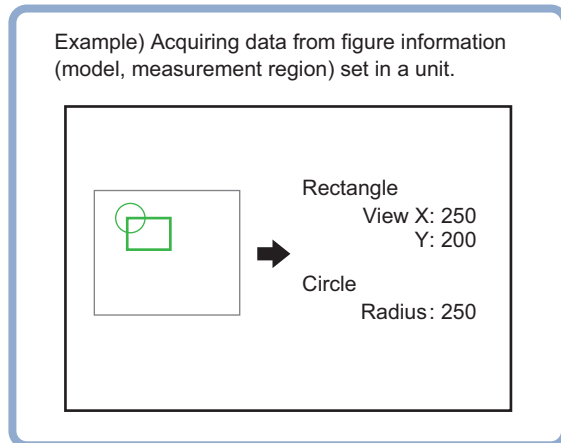

4-11-1 Parameter Settings (Get Unit Figure)

- 1 In the *Data setting* area, click ▼ at the right side of the *Unit* and set the target unit.

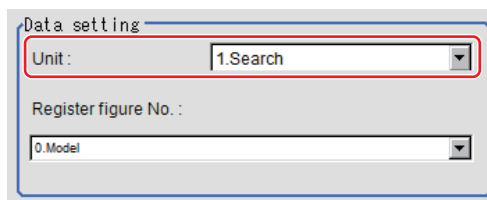

- 2 Click ▼ at the right side of the *Register figure No.* and set the register figure number to acquire.

4-11-2 Key Points for Test Measurement and Adjustment (Get Unit Figure)

The following content is displayed in the *Detail result* area as text.

Displayed item	Description
Judge	Judgment results 0: No judgment (unmeasured) 1: Judgment result OK -1: Judgment result NG -10: Error (image format mismatch) -11: Error (unregistered model) -12: Error (insufficient memory) -20: Error (other errors)
Target unit	Target unit which acquired figure
Register figure No.	Acquired figure number

4-11-3 Measurement Results for Which Output Is Possible (Get Unit Figure)

The following values can be output using processing items related to result output. It is also possible to reference measurement values from calculation expressions and other processing units.

Measurement items	Character string	Description
Judge	JG	Judgment results 0: No judgment (unmeasured) 1: Judgment result OK -1: Judgment result NG -10: Error (image format mismatch) -11: Error (unregistered model) -12: Error (insufficient memory) -20: Error (other errors)
Number of figures	NUM	Number of acquired figures
Size of figures	SIZ	Size of acquired figures (No. of bytes)
Figure N type (N = 0 to 9)	FNT	Type of figure N 0x0000 → Undefined 0x0001 → Point 0x0002 → Line 0x0004 → Wide line 0x0008 → Rectangle 0x0010 → Ellipse 0x0020 → Circle 0x0040 → Circumference 0x0080 → Arc 0x0100 → Wide arc 0x0200 → Polygon 0 (zero) if no figures are acquired.
Figure N mode (N = 0 to 9)	FNM	Figure N drawing mode 0: OR 1: NOT 0 (zero) if no figures are acquired

Measurement items	Character string	Description
Figure N data 00 to 20 (N = 0 to 9)	FND00 to FND20	Data 0 to 20 of figure N <ul style="list-style-type: none"> • For points <ul style="list-style-type: none"> 0: X coordinate 1: Y coordinate • For lines <ul style="list-style-type: none"> 0: X coordinate for first point 1: Y coordinate for first point 2: X coordinate for second point 3: Y coordinate for second point • For wide lines <ul style="list-style-type: none"> 0: X coordinate for first point 1: Y coordinate for first point 2: X coordinate for second point 3: Y coordinate for second point 4: Width • For rectangles <ul style="list-style-type: none"> 0: X coordinate for upper left point 1: Y coordinate for upper left point 2: X coordinate for lower right point 3: Y coordinate for lower right point • For ellipses <ul style="list-style-type: none"> 0: X coordinate for center point 1: Y coordinate for center point 2: Radius in X direction 3: Radius in Y direction • For circles <ul style="list-style-type: none"> 0: X coordinate for center point 1: Y coordinate for center point 2: Radius • For circumferences <ul style="list-style-type: none"> 0: X coordinate for center point 1: Y coordinate for center point 2: Radius 3: Width • For arcs <ul style="list-style-type: none"> 0: X coordinate for center point 1: Y coordinate for center point 2: Radius 3: Start angle of arc 4: End angle of arc • For wide arcs <ul style="list-style-type: none"> 0: X coordinate for center point 1: Y coordinate for center point 2: Radius 3: Start angle of arc 4: End angle of arc 5: Width

Measurement items	Character string	Description
		<ul style="list-style-type: none"> For polygons 0: Number of vertexes 1: X coordinate for vertex 0 2: Y coordinate for vertex 0 3: X coordinate for vertex 1 4: Y coordinate for vertex 1 5: X coordinate for vertex 2 6: Y coordinate for vertex 2 : : 19: X coordinate for vertex 9 20: Y coordinate for vertex 9 0 (zero) if no figures are acquired.

4-11-4 External Reference Tables (Get Unit Figure)

No.	Data name	Data ident	Set/Get	Data range
0	Judge	judge	Get only	0: No judgment (unmeasured), 1: Judgment result OK, -1: Judgment result NG, -10: Error (image format mismatch), -11: Error (unregistered model), -12: Error (insufficient memory), -20: Error (other errors)
1	Number of figures	num	Get only	Number of figures acquired
2	Size of figures	size	Get only	Size of figures acquired
120	Target processing unit No.	unitNo	Set/Get	0 to 9,999
121	Target figure No.	figureNo	Set/Get	0 to 1,000
1,000	Figure 0 type	F0T	Get only	Type of Figure 0: 0x0000 -> Undefined, 0x0001 -> Point, 0x0002 -> Line, 0x0004 -> Wide line, 0x0008 -> Rectangle, 0x0010 -> Ellipse, 0x0020 -> Circle, 0x0040 -> Wide circle, 0x0080 -> Arc, 0x0100 -> Wide arc, 0x0200 -> Polygon. Set to 0 if no figures are captured.
1,001	Figure 0 drawing mode	F0M	Get only	Figure 0 drawing mode
1,002+N (N=0 to 20)	Figure 0 data	F0D00 to F0D20	Get only	Data of Figure 0: 0 to 20. The No. of valid data differs with a type of data. Set to 0 if disabled or no figures are captured.

No.	Data name	Data ident	Set/Get	Data range
1,100	Figure 1 type	F1T	Get only	Type of Figure 1: 0x0000 -> Undefined, 0x0001 -> Point, 0x0002 -> Line, 0x0004 -> Wide line, 0x0008 -> Rectangle, 0x0010 -> Ellipse, 0x0020 -> Circle, 0x0040 -> Wide circle, 0x0080 -> Arc, 0x0100 -> Wide arc, 0x0200 -> Polygon. Set to 0 if no figures are captured.
1,101	Figure 1 drawing mode	F1M	Get only	Figure 1 drawing mode
1,102+N (N=0 to 20)	Figure 1 data	F1D00 to F1D20	Get only	Data of Figure 1: 0 to 20. The No. of valid data differs with a type of data. Set to 0 if disabled or no figures are captured.
1,200	Figure 2 type	F2T	Get only	Type of Figure 2: 0x0000 -> Undefined, 0x0001 -> Point, 0x0002 -> Line, 0x0004 -> Wide line, 0x0008 -> Rectangle, 0x0010 -> Ellipse, 0x0020 -> Circle, 0x0040 -> Wide circle, 0x0080 -> Arc, 0x0100 -> Wide arc, 0x0200 -> Polygon. Set to 0 if no figures are captured.
1,201	Figure 2 drawing mode	F2M	Get only	Figure 2 drawing mode
1,202+N (N=0 to 20)	Figure 2 data	F2D00 to F2D20	Get only	Data of Figure 2: 0 to 20. The No. of valid data differs with a type of data. Set to 0 if disabled or no figures are captured.
1,300	Figure 3 type	F3T	Get only	type of Figure 3: 0x0000 -> Undefined, 0x0001 -> Point, 0x0002 -> Line, 0x0004 -> Wide line, 0x0008 -> Rectangle, 0x0010 -> Ellipse, 0x0020 -> Circle, 0x0040 -> Wide circle, 0x0080 -> Arc, 0x0100 -> Wide arc, 0x0200 -> Polygon. Set to 0 if no figures are captured.
1,301	Figure 3 drawing mode	F3M	Get only	Figure 3 drawing mode
1,302+N (N=0 to 20)	Figure 3 data	F3D00 to F3D20	Get only	Data of Figure 3: 0 to 20. The No. of valid data differs with a type of data. Set to 0 if disabled or no figures are captured.

No.	Data name	Data ident	Set/Get	Data range
1,400	Figure 4 type	F4T	Get only	Type of Figure 4: 0x0000 -> Undefined, 0x0001 -> Point, 0x0002 -> Line, 0x0004 -> Wide line, 0x0008 -> Rectangle, 0x0010 -> Ellipse, 0x0020 -> Circle, 0x0040 -> Wide circle, 0x0080 -> Arc, 0x0100 -> Wide arc, 0x0200 -> Polygon. Set to 0 if no figures are captured.
1,401	Figure 4 drawing mode	F4M	Get only	Figure 4 drawing mode
1,402+N (N=0 to 20)	Figure 4 data	F4D00 to F4D20	Get only	Data of Figure 4: 0 to 20. The No. of valid data differs with a type of data. Set to 0 if disabled or no figures are captured.
1,500	Figure 5 type	F5T	Get only	Type of Figure 5: 0x0000 -> Undefined, 0x0001 -> Point, 0x0002 -> Line, 0x0004 -> Wide line, 0x0008 -> Rectangle, 0x0010 -> Ellipse, 0x0020 -> Circle, 0x0040 -> Wide circle, 0x0080 -> Arc, 0x0100 -> Wide arc, 0x0200 -> Polygon. Set to 0 if no figures are captured.
1,501	Figure 5 drawing mode	F5M	Get only	Figure 5 drawing mode
1,502+N (N=0 to 20)	Figure 5 data	F5D00 to F5D20	Get only	Data of Figure 5: 0 to 20. The No. of valid data differs with a type of data. Set to 0 if disabled or no figures are captured.
1,600	Figure 6 type	F6T	Get only	Type of Figure 6: 0x0000 -> Undefined, 0x0001 -> Point, 0x0002 -> Line, 0x0004 -> Wide line, 0x0008 -> Rectangle, 0x0010 -> Ellipse, 0x0020 -> Circle, 0x0040 -> Wide circle, 0x0080 -> Arc, 0x0100 -> Wide arc, 0x0200 -> Polygon. Set to 0 if no figures are captured.
1,601	Figure 6 drawing mode	F6M	Get only	Figure 6 drawing mode
1,602+N (N=0 to 20)	Figure 6 data	F6D00 to F6D20	Get only	Data of Figure 6: 0 to 20. The No. of valid data differs with a type of data. Set to 0 if disabled or no figures are captured.

No.	Data name	Data ident	Set/Get	Data range
1,700	Figure 7 type	F7T	Get only	Type of Figure 7: 0x0000 -> Undefined, 0x0001 -> Point, 0x0002 -> Line, 0x0004 -> Wide line, 0x0008 -> Rectangle, 0x0010 -> Ellipse, 0x0020 -> Circle, 0x0040 -> Wide circle, 0x0080 -> Arc, 0x0100 -> Wide arc, 0x0200 -> Polygon. Set to 0 if no figures are captured.
1,701	Figure 7 drawing mode	F7M	Get only	Figure 7 drawing mode
1,702+N (N=0 to 20)	Figure 7 data	F7D00 to F7D20	Get only	Data of Figure 7: 0 to 20. The No. of valid data differs with a type of data. Set to 0 if disabled or no figures are captured.
1,800	Figure 8 type	F8T	Get only	Type of Figure 8: 0x0000 -> Undefined, 0x0001 -> Point, 0x0002 -> Line, 0x0004 -> Wide line, 0x0008 -> Rectangle, 0x0010 -> Ellipse, 0x0020 -> Circle, 0x0040 -> Wide circle, 0x0080 -> Arc, 0x0100 -> Wide arc, 0x0200 -> Polygon. Set to 0 if no figures are captured.
1,801	Figure 8 drawing mode	F8M	Get only	Figure 8 drawing mode
1,802+N (N=0 to 20)	Figure 8 data	F8D00 to F8D20	Get only	Data of Figure 8: 0 to 20. The No. of valid data differs with a type of data. Set to 0 if disabled or no figures are captured.
1,900	Figure 9 type	F9T	Get only	Type of Figure 9: 0x0000 -> Undefined, 0x0001 -> Point, 0x0002 -> Line, 0x0004 -> Wide line, 0x0008 -> Rectangle, 0x0010 -> Ellipse, 0x0020 -> Circle, 0x0040 -> Wide circle, 0x0080 -> Arc, 0x0100 -> Wide arc, 0x0200 -> Polygon. Set to 0 if no figures are captured.
1,901	Figure 9 drawing mode	F9M	Get only	Figure 9 drawing mode
1,902+N (N=0 to 20)	Figure 9 data	F9D00 to F9D20	Get only	Data of Figure 9: 0 to 20. The No. of valid data differs with a type of data. Set to 0 if disabled or no figures are captured.

4-12 Trend Monitor

Enables the history of the measurement results to be displayed on the monitor.

Used in the Following Case

- When preventing defective products from frequently occurring:

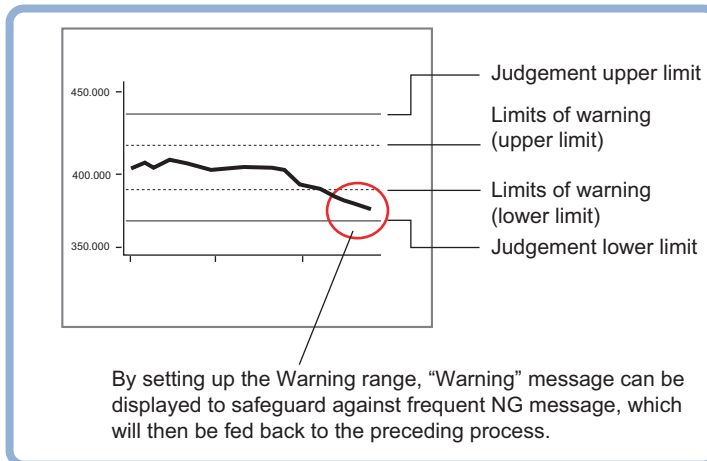

- When performing a cause analysis at NG occurrence:

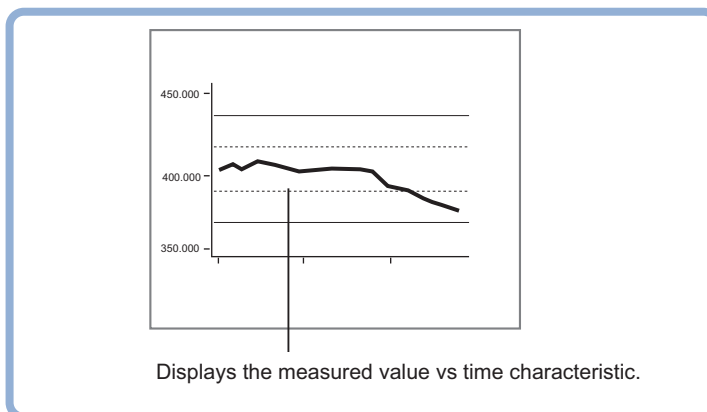

List of Trend Monitor Items

Item	Description
measurements	Sets measurement values to display on the trend monitor. <i>4-12-1 Measurement Values (Trend Monitor) on page 4-68</i>
Display range	Sets the display range. Moreover, the display range toward the graph vertical direction can be scrolled and that can be zoomed in/out. <i>4-12-2 Display Range (Trend Monitor) on page 4-68</i>
Judgment condition	Sets the conditions to judge the measurement results as OK and the warning range to call attention before frequent NG occurrences. <i>4-12-3 Judgment (Trend Monitor) on page 4-71</i>
History display	Displays the measurement history. <i>4-12-4 Measurement History Display (Trend Monitor) on page 4-72</i>

Item	Description
Data save	Saves measurement results recorded in the Trend Monitor to external memory devices such as a USB flash drive. 4-12-5 Data Save (Trend Monitor) on page 4-74

4-12-1 Measurement Values (Trend Monitor)

Set the measurement values to be viewed on the trend monitor. The display available item is one per one trend monitor unit.

- 1 In the Item tab area, click **Measurement**.
- 2 In the *Expression* area, click  at the right end of the *Measurement data* and set the measurement value for monitoring target with a calculation expression.
The *Measurement* window is displayed.
Select a unit number processed prior to *Trend Monitor*. Even if selecting a unit number hereafter this unit, no graph is displayed.

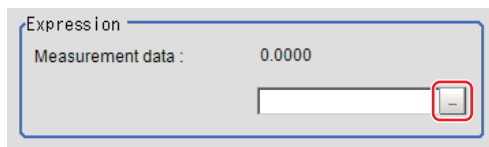

- 3 Set the *Number of saving* as necessary.

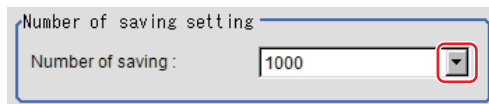

Setting item	Setting value [Factory default]	Description
Number of saving	<ul style="list-style-type: none"> • [1000] • 5000 • 10000 • 50000 • 100000 	<p>Sets the number of savings for measurement values.</p> <p>In the main window, up to 5,000 measurement values are displayed.</p> <p>Exceeding 5,000 measurement values are displayed with switching page.</p>



Precautions for Correct Use

- There is the following tradeoff between the number of savings and the sensor controller performance.
- There are approximately 2 MB differences in data memory consumption when comparing 1,000 with 100,000 in measurement items. Check the free memory amount before setting.

4-12-2 Display Range (Trend Monitor)

If what you want to see is not displayed, scroll the graph vertically or zoom in or out. Also, items displayed horizontally can be toggled.

- 1 In the Item tab area, click **Display range**.
A graph is displayed in the *Image Display* area.

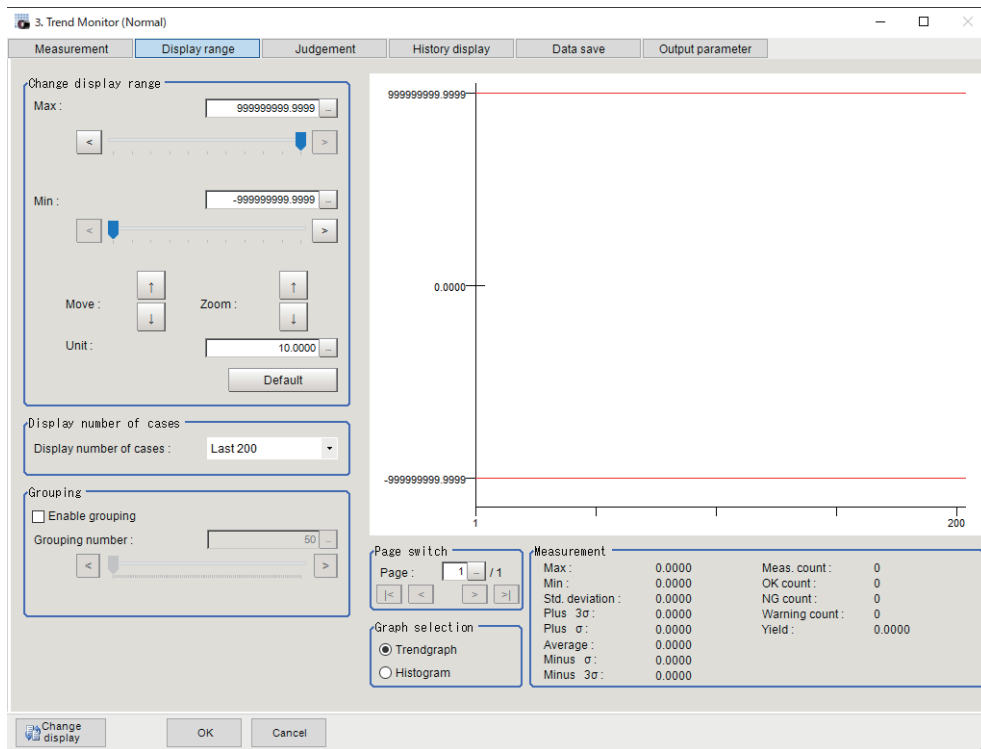

Additional Information

When opening this window after measuring multiple times and clicking **Default**, the display range optimized to the measurement values are automatically set.

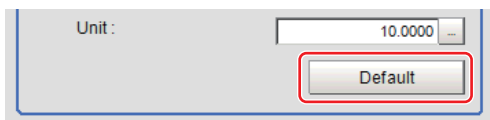

Setting item		Setting value [Factory default]	Description
Change display range	Max.	-999,999,999.9999 to 999,999,999.9999	Sets the upper (Max. value) and lower (Min. value) sections in the graph.
	Min.	-999,999,999.9999 to 999,999,999.9999	
	Move	<ul style="list-style-type: none"> • ↑ • ↓ 	Moves the graph vertically.
	Zoom	<ul style="list-style-type: none"> • ↑ • ↓ 	Zoom the graph in/out.
	Unit	1 to 1,000,000.0000	Sets the change amount when clicking ↑ or ↓ of Move or Zoom button.
	Default	-	When multiple measurements have been already done until then, the optimized display range is automatically set based on the measurement results.

Setting item	Setting value [Factory default]	Description
Display number of cases	<ul style="list-style-type: none"> • [last 200] • [last 1,000] • [last 5,000] • [last 10,000] • [last 500,000] • [last 100,000] 	Selects the number of items to display in the graph horizontally.
Enable grouping	<ul style="list-style-type: none"> • [Checked] • Unchecked 	Draws a rectangle indicating the max. and min. values of the measurement data per the number of specified items. Enables you to grasp the max. and min. values in a section at a glance.
	0 to 5,000 [50]	Sets the number of items that can be grouped.

● Move

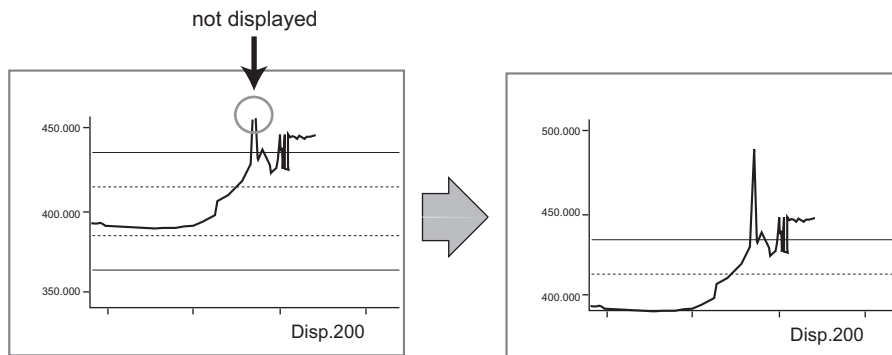

● Zoom

Ex.: To enlarge a part in which measurement results were unstable.

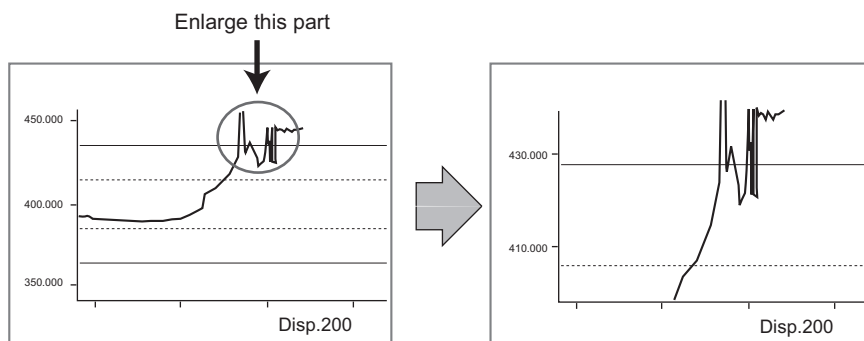

● Horizontal

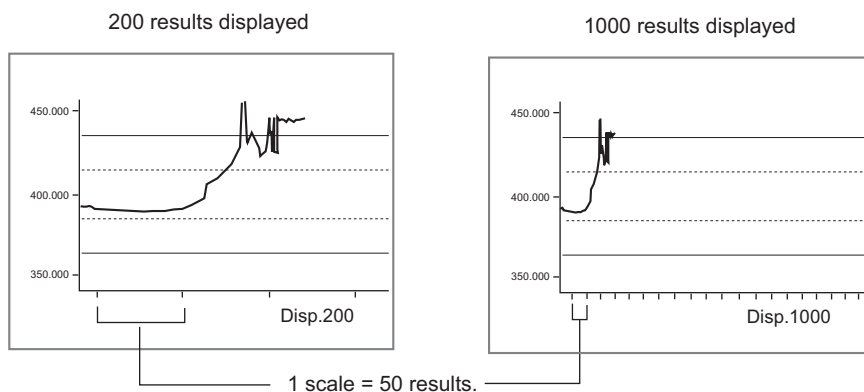

4-12-3 Judgment (Trend Monitor)

Here, set OK/NG judgement conditions and warning range to call attention before frequent NG occurrences.

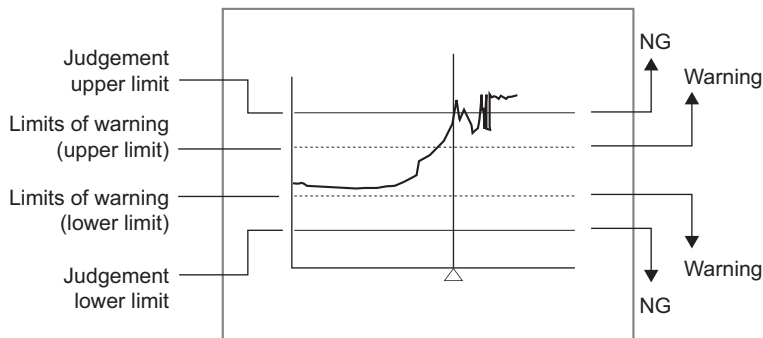

Additional Information

A message of *Limits of warning* is displayed on the screen when a warning occurred. A warning occurrence can also be output to external devices by using a processing item related to *Result Output* such as *Parallel Judgement Output* if a calculation expression is set to output the measurement result of Trend Monitor (warning).

1 In the Item tab area, click **Judgment**.

2 Set the judgment condition.

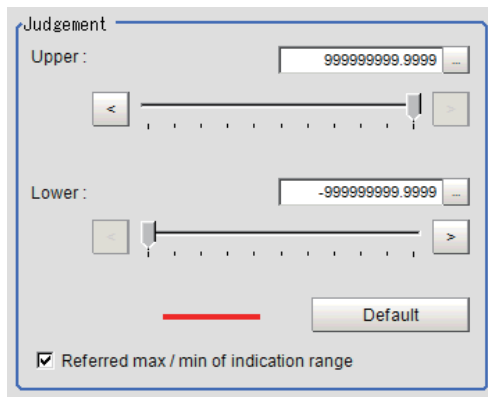

Setting item	Setting value	Description
Upper	-999,999,999.9999 to 999,999,999.9999	Sets the judgment range that the measurement result is judged as OK.
Lower	-999,999,999.9999 to 999,999,999.9999	
Referred max./min. of indication range	<ul style="list-style-type: none"> • [Checked] • Unchecked 	When checked, the judgment range settable with the upper and lower values will be the max. and min. values set in the Display range .



Additional Information

When opening this window after measuring multiple times and clicking **Default**, the display range optimized to the measurement values are automatically set.



3 In the Warning area, set the *Upper* and *Lower*.

The setting method is the same as that of the *Judgment* area.

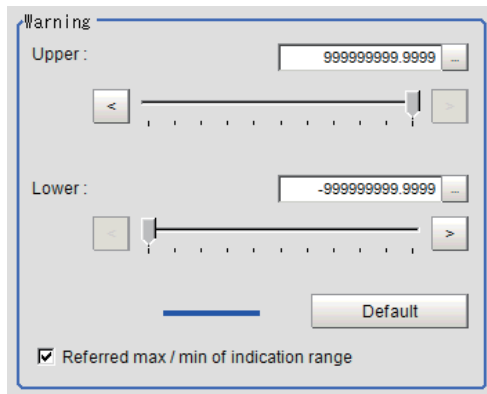

Setting item	Setting value [Factory default]	Description
Upper	-999,999,999.9999 to 999,999,999.9999 [999,999,999.9999]	Sets the warning range to call attention before frequent NG occurrence.
Lower	-999,999,999.9999 to 999,999,999.9999 [-999,999,999.999 9]	
Referred max./min. of indication range	<ul style="list-style-type: none"> • [Checked] • Unchecked 	When checked, the judgment range settable with the upper and lower values will be the max. and min. values set in the Display range .

4-12-4 Measurement History Display (Trend Monitor)

Displays the measurement history.

- 1** In the Item tab area, click **History display**.
- 2** In the *Measurement history* area, click a judgment to display.

Judge	Count	Value	Time
OK	761	320.0000	18:28:57
OK	760	321.0000	18:28:57
OK	759	321.0000	18:28:57
OK	758	321.0000	18:28:57
OK	757	321.0000	18:28:57
OK	756	316.0000	18:28:57
OK	755	320.0000	18:28:56
OK	754	320.0000	18:28:56
OK	753	321.0000	18:28:56
OK	752	321.0000	18:28:56
OK	751	320.0000	18:28:56
OK	750	321.0000	18:28:56
OK	749	321.0000	18:28:56
OK	748	320.0000	18:28:56
OK	747	321.0000	18:28:56

The measurement value and time are displayed.

In the *Image display* area, vertical lines for NG positions overlaid on the graph, which indicates positions at which NG has occurred.

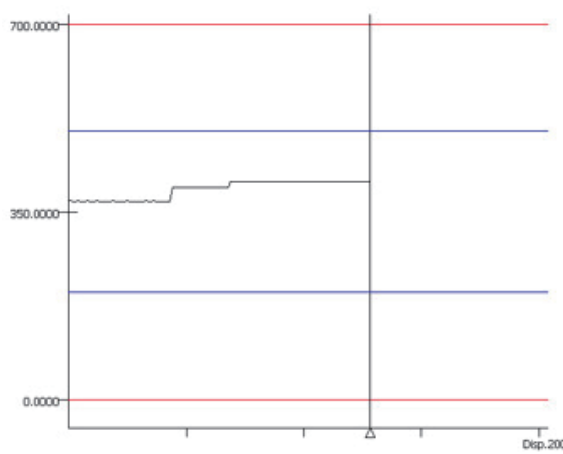

3 Set a filter as necessary.

Filtering

Judge : All Only OK Only NG

Sort order :

Setting item	Setting value [Factory default]	Description
Judgment	<ul style="list-style-type: none"> All Only OK [Only NG] 	Selects the judgment results to be displayed.
Sort order	<ul style="list-style-type: none"> Count ascending [Count descending] Value ascending Value descending 	Selects the sort order for the judgment results to be displayed.

4 Set a display graph as necessary.

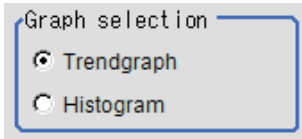

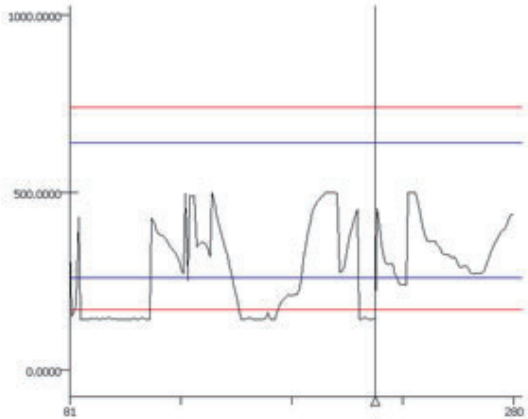
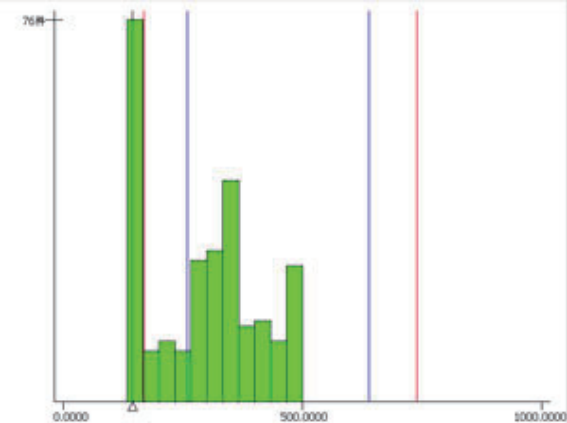
Setting item	Setting value [Factory default]	Description
Graph selection	<ul style="list-style-type: none"> [Trend graph] Histogram 	<ul style="list-style-type: none"> Trend graph: The vertical direction shows measurement values and the horizontal direction shows the number of items. This graph is convenient when to check the relationship between measurement changes and over time.  <ul style="list-style-type: none"> Histogram: The vertical direction shows the number of items and the horizontal direction shows the measurement values. This is convenient to check the distribution. 

4-12-5 Data Save (Trend Monitor)

Possible to save measurement results recorded in the Trend Monitor to an SD card (for FH series), a microSD card (for FHV series) and USB flash drive. Since the data is saved in CSV format, it can be edited on a PC.

The data to be saved is all statistic data, measurement values and time at NG occurrence (max. 36 items), and measurement results on the graph (Max. 1,000 items). An extended format can save up to 100,000 measurement results. The format is below.

Data is partitioned using commas.

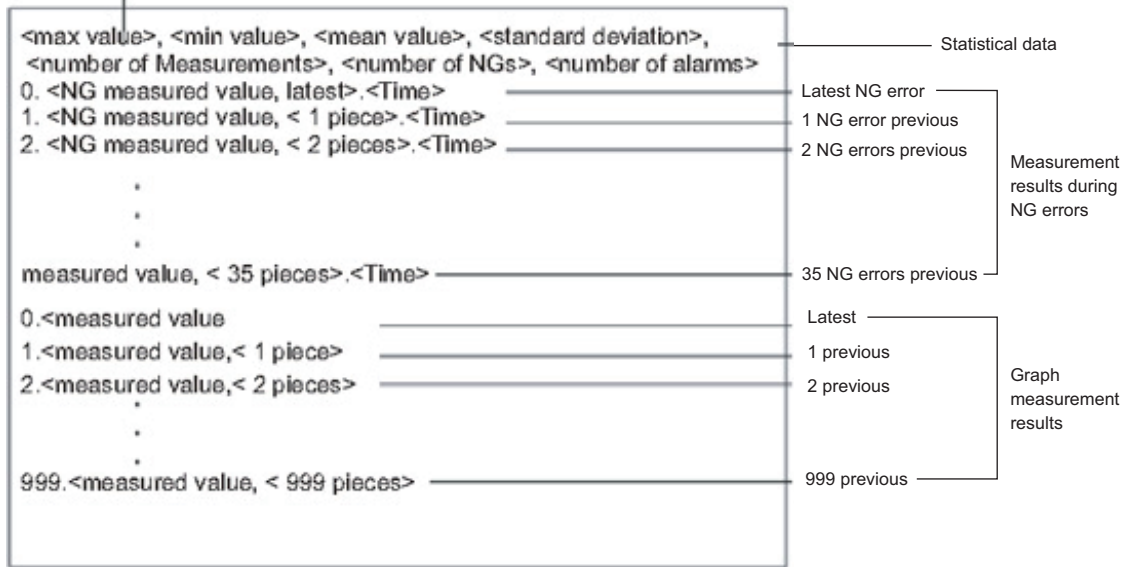

Precautions for Correct Use

Before saving, insert a USB flash drive, SD memory card or microSD memory card to slots. Regarding the slot positions, refer to the instruction sheet, *Vision System FH series Hardware Setup Manual (Cat. No. Z366)* or *Smart Camera FHV series Setup Manual (Cat. No. Z408)*.

- 1 In the Item Tab area, click **Data save**.
- 2 In the *Save setting* area, set formats.
 - Standard format:

Line	Text	Description	
1	<Maximum>, <Minimum>, <Average>, <Deviation>, <Count>, <NG count>, <Warning count>	Statistical data	
2			
3	0, <NG measured value, latest>, <Time>	Last NG	Measurement results at (Max. 36 items)
4	1, <last 1 NG measurement>, <Time>	Last 1 NG	
5	2, <Last 2 NG measurement>, <Time>	Last 2 NG	
:	:	:	
38	35, <Last 35 NG measurement>, <Time>	Last 35 NG	
39			
40	0, <measured value, latest>	Last	Measurement results (Max. 1,000 items)
41	1, <Last 1 measurement>	Last 1	
42	2, <Last 2 measurement>	Last 2	
:	:	:	
1,039	999, <Last 999 measurement>	Last 999	

- Extended format:

Line	Text	Description	
1	<Maximum>, <Minimum>, <Deviation>, <Plus 3 σ >, <Plus σ >, <Average>, <Minus σ >, <Minus 3 σ >, <Count>, <OK count>, <NG count>, <Warning count>, <Yield>	Statistical data	
2			
3	0, <judgment result, latest>, <measured value, latest>, <Time>	Last	Measurement results (max. 100,000)
4	1, <Last 1 judgment result>, <Last 1 Measurement>, <Time>	Last 1	
5	2, <Last 2 judgment result>, <Last 2 Measurement>, <Time>	Last 2	
:	:	:	
100,002	99,999, <Last 99,999 judgment result>, <Last 99,999 Measurement>, <Time>	Last 99,999	



Additional Information

The default file name is the data saved date (ex. 0410.CSV). For half-width alphanumeric, it can be changed arbitrarily.

- In the *Save setting* area, click **Save**.
The data is saved into a USB flash drive or memory card.

4-12-6 Output parameter (Trend Monitor)

Select whether or not to reflect the judgment results of this processing unit to the overall judgment of the scene.

- In the Item tab area, click **Output parameter**.
- Select whether or not to reflect it to the overall judgment in *Reflect to overall judgement* area.

Setting item	Setting value [Factory default]	Description
Reflect to overall judgment	<ul style="list-style-type: none"> [ON] OFF 	Enables choosing whether or not the judgement results of this processing unit is reflected in the scene overall judgment.

4-12-7 Key Points for Test Measurement and Adjustment (Trend Monitor)

The following content is displayed in the *Detail result* area as text.

Displayed item	Description
Judge	Judgment results 0: No judgment (unmeasured) 1: Judgment result OK -1: Judgment result NG -10: Error (image format mismatch) -11: Error (unregistered model) -12: Error (insufficient memory) -20: Error (other errors)
Measurement	Latest measured value
Max.	Max. measurement value during recording period
Min.	Min. measurement value during recording period
Standard deviation	Sample standard deviation for measurement values during recording period
Plus 3σ	Average of measurement values during period recorded + standard deviation values $\times 3$
Plus σ	Average of measurement values during period recorded + standard deviation values
Average	Average value for measurement values during recording period
Minus σ	Average of measurement values during period recorded - standard deviation values
Minus 3σ	Average of measurement values during period recorded - standard deviation values $\times 3$
No. of measurements	No. of measurements from the start of measurement.
OK count	No. of measurements from the start of measurement - No. of NGs in the No. of measurements
NG count	No. of NGs in the No. of measurements
Warning count	No. of warnings in the No. of measurements
Yield	OK count/No. of measurements

The image specified in the Sub-image number in the image display setting is displayed in the *Image Display* area.

Sub-image number	Description of image to be displayed
0	Trend graph
1	Histogram

4-12-8 Measurement Results for Which Output Is Possible (Trend Monitor)

The following values can be output using processing items related to result output. It is also possible to reference measurement values from calculation expressions and other processing units.

Measurement items	Character string	Description
Judge	JG	Judgment results 0: No judgment (unmeasured) 1: Judgment result OK -1: Judgment result NG -10: Error (image format mismatch) -11: Error (unregistered model) -12: Error (insufficient memory) -20: Error (other errors)

Measurement items	Character string	Description
Measurement	DT	Latest measured value
Warning	WN	Warning happened or not
Max.	MX	Max. measurement value during recording period
Min.	MN	Min. measurement value during recording period
Standard deviation	DV	Sample standard deviation for measurement values during recording period
Plus 3σ	AP3	Average of measurement values during period recorded + standard deviation values $\times 3$
Plus σ	AP1	Average of measurement values during period recorded + standard deviation values
Average	AV	Average value for measurement values during recording period
Minus σ	AM1	Average of measurement values during period recorded - standard deviation values
Minus 3σ	AM3	Average of measurement values during period recorded - standard deviation values $\times 3$
No. of measurements	MC	Measurement count since the beginning of measurement
OK count	OC	No. of measurements - NG count
NG count	NC	Number of NG occurrences within the No. of measurements
Warning count	WC	Warning count within the No. of measurement
Yield	YD	OK count /No. of measurements

 **Note**

If the total measurement value data exceeds -1.0×10^{11} to 1.0×10^{11} , the measurement will be disabled (NG).

Regularly clear the measurement values so that the total measurement value data stays within the range.

4-12-9 External Reference Tables (Trend Monitor)

No.	Data name	Data ident	Set/Get	Data range
0	Judge	judge	Get only	0: No judgment (unmeasured), 1: Judgment result OK, -1: Judgment result NG, -10: Error (image format mismatch), -11: Error (unregistered model), -12: Error (insufficient memory), -20: Error (other errors)
5	Measurement	measurement	Get only	-999,999,999.9999 to 999,999,999.9999
6	Warning	warning	Get only	0: OFF, 1: ON
7	Maximum	max	Get only	-999,999,999.9999 to 999,999,999.9999
8	Minimum	min	Get only	-999,999,999.9999 to 999,999,999.9999

No.	Data name	Data ident	Set/Get	Data range
9	Average	average	Get only	-999,999,999.9999 to 999,999,999.9999
10	Deviation	deviation	Get only	-999,999,999.9999 to 999,999,999.9999
11	Count	measureCount	Get only	0 to 999,999,999
12	NG count	ngCount	Get only	0 to 999,999,999
13	Warning count	warnCount	Get only	0 to 999,999,999
14	Average plus + 3 σ	avePlus3Sigma	Get only	-999,999,999.9999 to 999,999,999.9999
15	Average plus + σ	avePlusSigma	Get only	-999,999,999.9999 to 999,999,999.9999
16	Average minus - σ	aveMinusSigma	Get only	-999,999,999.9999 to 999,999,999.9999
17	Average minus -3 σ	aveMinus3Sigma	Get only	-999,999,999.9999 to 999,999,999.9999
18	OK count	okCount	Get only	0 to 999,999,999
19	yield	yield	Get only	0 to 1
103	Reflect to overall judgement	overallJudge	Set/Get	0: ON, 1: OFF
120	Expression	expression	Set/Get	Exp. character string
121	Upper limit of the judgement	upperJudge	Set/Get	-999,999,999.9999 to 999,999,999.9999
122	Lower limit of the judgement	lowerJudge	Set/Get	-999,999,999.9999 to 999,999,999.9999
123	Warning upper limit	upperWarn	Set/Get	-999,999,999.9999 to 999,999,999.9999
124	Warning lower limit	lowerWarn	Set/Get	-999,999,999.9999 to 999,999,999.9999
125	Upper limit of the display range	maxVertical	Set/Get	-999,999,999.9999 to 999,999,999.9999
126	Lower limit of the display range	minVertical	Set/Get	-999,999,999.9999 to 999,999,999.9999
127	Amount of change to display range	unitVertical	Set/Get	1 to 1,000,000
128	Display number of cases	horizontal	Set/Get	0: Display 200 results, 1: Display 1,000 results, 2: Display 5,000 results, 3: Display 10,000 results, 4: Display 50,000 results, 5: Display 100,000 results
129	Grouping	grouping	Set/Get	0: OFF, 1: ON
130	Grouping count	groupingCount	Set/Get	2 to 100,000
131	Max. save count	maxSaveCount	Set/Get	0: Last 1,000, 1: Last 5,000, 2: Last 10,000, 3: Last 50,000, 4: Last 100,000

4-13 Image Logging

This is used when saving measurement images to on-board memory, RAMDisk, or USB flash drive. This enables preparation of logging conditions using an expression and is more flexible than the system image logging conditions settings.

However, the settings of this unit are enabled if *None* is set on the *Image logging* in *Logging setting* of **System settings** menu.

For details, refer to *Logging Measurement Values and Measurement Images [Data Logging /Image Logging]* in the Vision Sensor FH/FHV Series Vision System User's Manual (Cat. No. Z365).

If settings that perform image logging for multiple units during measurement are executed, the last settings executed are enabled.

Used in the Following Case

When saving logging images under certain conditions

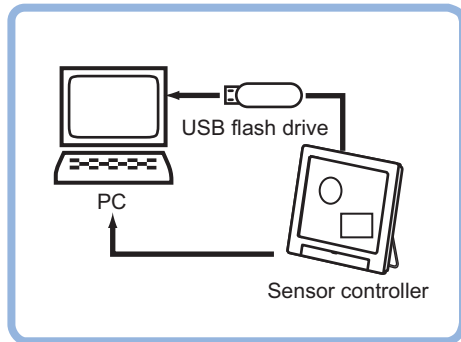

Precautions for Correct Use

- When multiple image logging units are set in the measurement flow, images are saved according to the image logging conditions last performed.
- When **Multiple image logging** on the **Logging setting** in the **System** menu is set to *ON*.
 - All transferred images are saved according to the settings for the *Logging conditions*.
 - Since all transferred images are saved on the onboard memory temporarily, the latest images exceeding the memory size are deleted.
- When **Save to memory + FTP Server** is selected for the save destination, use half-width alphanumeric characters to specify the destination folder name and prefix of image logging file.

4-13-1 Logging Conditions (Image Logging)

Sets images to log. When four cameras are connected, images are logged for four cameras at time.

- 1** In the Item tab area, click **Logging condition**.
- 2** Set the logging conditions.

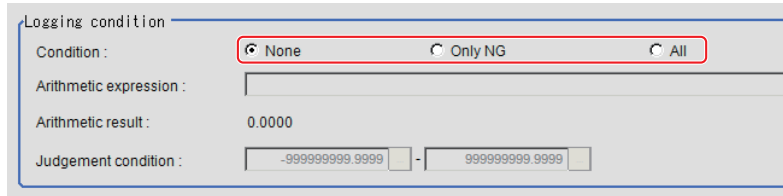

Setting item	Setting value [Factory default]	Description
Condition	<ul style="list-style-type: none"> [None] Only NG All 	<ul style="list-style-type: none"> None: saves no images. Only NG: Saves images only at NG occurrence. Images will not be logged even if NG occurred hereafter this processing unit. Set this processing item as close to the end of the measurement flow. All: Saves all measured images.

- When *Only NG* is selected, specify the expression by clicking  at the right end of the Arithmetic expression text box. The *Setting expression* dialog is displayed.
- After setting up the expression, click **OK**. The expression is confirmed.
- Set the upper and lower judgment limits in the *Judgment condition*.

Setting item	Setting value	Description
Judgment condition	-999,999,999.9999 to 999,999,999.9999	This judgment condition is for the expression. Set the upper and lower limits to judge OK.

4-13-2 Save Destination (Image Logging)



Additional Information

The save file name consists of the *prefix + measurement ID*. For details, refer to *4-15-2 Output Format (Data Logging)* on page 4-92.

- In the Item tab area, click **Destination**.
- Set the save destination for logging images. This is enabled when *Save to memory + file* is selected for the save destination in the system image logging settings.

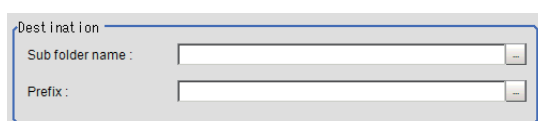

Setting item	Setting value [Factory default]	Description
Sub folder name	-	Specifies the subfolder name. The sub folder is generated as the save destination in the system logging settings. (Max. 32 characters) The following characters are not available for this. \\ / : * ? " < >
Prefix	-	Sets the prefix for the save file name. (Max. 31 characters). The set character string is added to the top of the save file name. When the prefix for the system logging setting is set, the file name consists of the <i>prefix specified in image logging</i> + the <i>prefix specified in the system logging</i> + image logging file name.

3 Set the *File count in folder* as necessary.

Saving so many files in the subfolder set as the *Save destination* lowers the performance and visibility. In that case, creating multiple folders in the subfolder prevents deterioration in performance or visibility.



Setting item	Setting value [Factory default]	Description
File count in folder	0 to 999 [200]	Sets the upper limit for the number of files to automatically generate folders in the subfolder set in the Destination . The number of files are not that saved in the automatically generated folders but the total number of generated image files. Folder names automatically generated is the same as that of an image logging file firstly saved in the folder. If zero is specified, folders are not generated automatically.



Additional Information

When the specified value for the *File count in folder* is other than 0, in the following case, the number of files saved in the folder generated in the subfolder may not meet the specified value.

- When *Clear measurement on Function* in the Main window is performed, folders are automatically generated in the subfolder regardless of the specified value for the *File count in folder*. For details, refer to *Clear measurement* in the *Vision System FH/FHV Series User's Manual (Cat. No. Z365)*.
- When the *Manage folders* on the **Logging setting** in the **System settings** is set, folders are automatically generated in the subfolder according to the number of generated total image files. For details, refer to *Logging conditions* in the *Vision System FH/FHV Series User's Manual (Cat. No. Z365)*.

**Precautions for Correct Use**

- When *Conditional Branch* function is used, the number of saved files may be different from the number of specified files.
- When the operation mode is set to *Double Speed Multi-input* mode, images measured at odd-number-th and at even-number-th are saved in different folders respectively.
- When the operation mode is set to *Non-stop adjustment* mode, before and after non-stop adjustment, the number of files in folders may be different from the number of files specified.

4-13-3 Key Points for Test Measurement and Adjustment (Image Logging)

The following content is displayed in the *Detail result* area as text.

Displayed item	Description
Judge	Judgment results 0: No judgment (unmeasured) 1: Judgment result OK -1: Judgment result NG -10: Error (image format mismatch) -11: Error (unregistered model) -12: Error (insufficient memory) -20: Error (other errors)
Expression	Calculation result of conditional expression

4-13-4 Measurement Results for Which Output Is Possible (Image Logging)

The following values can be output using processing items related to result output. It is also possible to reference measurement values from calculation expressions and other processing units.

Measurement items	Character string	Description
Judge	JG	Judgment results 0: No judgment (unmeasured) 1: Judgment result OK -1: Judgment result NG -10: Error (image format mismatch) -11: Error (unregistered model) -12: Error (insufficient memory) -20: Error (other errors)
Data	D00	Data of conditional expression
Judge	J00	judgment result of conditional expression

4-13-5 External Reference Tables (Image Logging)

No.	Data name	Data ident	Set/Get	Data range
0	Judge	judge	Get only	0: No judgment (unmeasured), 1: Judgment result OK, -1: Judgment result NG, -10: Error (image format mismatch), -11: Error (unregistered model), -12: Error (insufficient memory), -20: Error (other errors)
5	Calculation result	measurement	Get only	-99,999.9999 to 99,999.9999
6	Judgement result	judgment	Get only	0: No judgment (unmeasured), 1: Judgment result OK, -1: Judgment result NG
120	Logging condition	imageLogging	Set/Get	0: None, 1: Only NG, 2:All
121	Expressions of logging condition	expression	Set/Get	Exp. character string
122	Upper limit of conditions calculation	upperJudge	Set/Get	-999,999,999.9999 to 999,999,999.9999
123	Lower limit of conditions calculation	lowerJudge	Set/Get	-999,999,999.9999 to 999,999,999.9999
124	Sub directory name	saveDirectorySub	Set/Get	Character string
125	Prefix	prefix	Set/Get	Character string
130	Files in folder	fileCount	Set/Get	0 to 999

4-14 Image Conversion Logging

This processing item is used to save a measurement processing image in RAMDisk or a USB flash drive.

This enables preparation of logging conditions using an expression and is more flexible than the system image logging conditions settings.

The save range within the image can be specified with a rectangle and the image save format (BMP or JPG) is selectable.

Used in the Following Case

This is used when saving measurement images under certain conditions.

Measurement images are saved when *Image Conversion Logging* is registered in the measurement flow. The processing of *Filtering* and *Position Compensation* is also reflected.

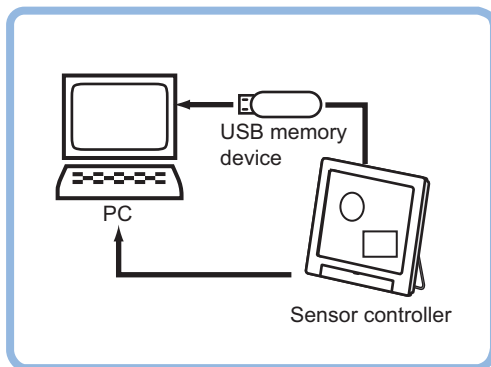

Precautions for Correct Use

Processing is different for color images and monochrome images. When the camera type used in the previous setup was changed to color or monochrome type, perform the settings again.

4-14-1 Save Conditions (Image Conversion Logging)

Specify the image to be logging.



Precautions for Correct Use

- One image per one processing unit can be saved with *Image Conversion Logging*. however, Inserting multiple processing units in the measurement flow enables multiple images to be saved.
- Even when *Multiple image logging* on the **Logging setting** in the **System settings** is set, images possible to be saved in *Image Conversion Logging* processing item is only one image input when the processing item is performed.

1 In the Item tab area, click **Save condition**.

2 Set save conditions.

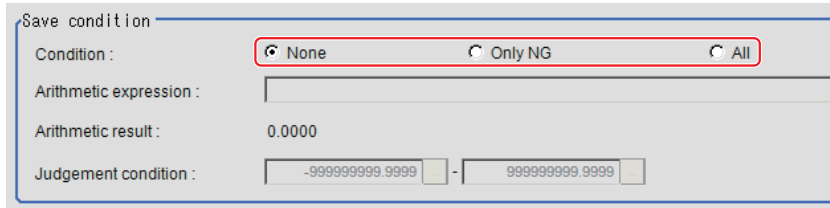

Setting item	Setting value [Factory default]	Description
Condition	<ul style="list-style-type: none"> • [None] • Only NG • All 	<ul style="list-style-type: none"> • None: saves no images. • Only NG: Saves images only at NG occurrence. Even if NG occurred in the processing units hereafter this unit, image conversion logging will not be performed. The OK or NG judgment is performed based on the measurement value when this unit is processed. • All: Saves all measured images.

3 When *Only NG* is selected, specify the expression by clicking  at the right end of the Arithmetic expression text box.
The *Setting expression* dialog is displayed.

4 Set the logging conditions with an expression.
For details, refer to *4-3-3 Layout of Setting Expression Window (Calculation)* on page 4-12.

5 After setting up the expression, click **OK**.
The expression is confirmed.

6 Set the upper and lower judgment limits in the *Judgment condition*.

Setting item	Setting value	Description
Judgment condition	-999,999,999.9999 to 999,999,999.9999	This judgment condition is for the expression. Set the upper and lower limits to judge OK.

7 In the *Format* area, specify the save format.

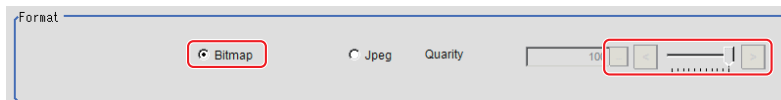

Setting item	Setting value [Factory default]	Description
Format	<ul style="list-style-type: none"> • [Bitmap] • Jpeg 	Selects the image format to be saved.
Quality	0 to 100 [100]	Sets the image quality to be saved as Jpeg.

4-14-2 Destination (Image Conversion Logging)



Additional Information

The file name to be saved consists of *prefix*, *measurement ID*, and *extension*. For details, refer to 4-15-2 *Output Format (Data Logging)* on page 4-92.

- 1 Set the save destination for logging images.

Setting item	Setting value [Factory default]	Description
Folder name	-	Specifies the folder name for the image to be saved. (Max. 32 characters) The following characters are not available for this. \\ : * ? " < >
Prefix	-	Specifies the prefix for the file name prefix to be saved. (Max. 32 characters) The specified character string will be added to the top of the save file. The prefix settings on the <i>Logging setting</i> in the <i>System settings</i> will be ignored.

- 2 Set the *File count in folder* as necessary.

Saving so many files in the subfolder set as the *Save destination* lowers the performance and visibility. In that case, creating multiple folders in the subfolder prevents deterioration in performance or visibility.

Setting item	Setting value [Factory default]	Description
File count in folder	0 to 999 [200]	Sets the upper limit for the number of files to automatically generate folders in the subfolder set in the Destination . The number of files are not that saved in the automatically generated folders but the total number of generated image files. Folder names automatically generated is the same as that of an image logging file firstly saved in the folder. If zero is specified, folders are not generated automatically.



Additional Information

When the specified value for the *File count in folder* is other than 0, in the following case, the number of files saved in the folder generated in the subfolder may not meet the specified value.

- When *Clear measurement on Function* in the Main window is performed, folders are automatically generated in the subfolder regardless of the specified value for the *File count in folder*. For details, refer to *Clear measurement* in the *Vision System FH/FHV Series User's Manual (Cat. No. Z365)*.



Precautions for Correct Use

- When the operation mode is set to *Double Speed Multi-input* mode, images measured at odd-number-th and at even-number-th are saved in different folders respectively.
- When the operation mode is set to *Non-stop adjustment* mode, before and after non-stop adjustment, the number of files in folders may be different from the number of files specified.

4-14-3 Area Setting (Image Conversion Logging)

Set the range for logging images.

- 1 In the Item tab area, click **Area Setting**.
- 2 Use the drawing tools to specify the range for the *Image Conversion Logging*.
- 3 In the *Figure setting* area, click **OK**.
 - **OK**: Changes the settings and returns to the previous menu.
 - **Cancel**: Changes are discarded and returns to the previous menu.
 - **Apply**: Updates the settings without leaving the current window.

The target range for logging images is registered.

4-14-4 Key Points for Test Measurement and Adjustment (Image Conversion Logging)

The following content is displayed in the *Detail result* area as text.

Displayed item	Description
Judge	Judgment results 0: No judgment (unmeasured) 1: Judgment result OK -1: Judgment result NG -10: Error (image format mismatch) -11: Error (unregistered model) -12: Error (insufficient memory) -20: Error (other errors)
Expression	Calculation result of conditional expression

4-14-5 Measurement Results for Which Output Is Possible (Image Conversion Logging)

The following values can be output using processing items related to result output. It is also possible to reference measurement values from calculation expressions and other processing units.

Measurement items	Character string	Description
Judge	JG	Judgment results 0: No judgment (unmeasured) 1: Judgment result OK -1: Judgment result NG -10: Error (image format mismatch) -11: Error (unregistered model) -12: Error (insufficient memory) -20: Error (other errors)
Data	D00	Data of conditional expression
Judge	J00	judgment result of conditional expression

4-14-6 External Reference Tables (Image Conversion Logging)

No.	Data name	Data ident	Set/Get	Data range
0	Judge	judge	Get only	0: No judgment (unmeasured), 1: Judgment result OK, -1: Judgment result NG, -10: Error (image format mismatch), -11: Error (unregistered model), -12: Error (insufficient memory), -20: Error (other errors)
5	Data(Conditional expression)	measurement	Get only	-999,999,999.9999 to 999,999,999.9999
6	Arithmetic judge(Conditional expression)	judgment	Get only	0: Unmeasured, 1: OK, -1: NG
120	Save condition	imageSaveMode	Set/Get	0: None, 1: Only NG, 2: All
121	Expressions of save condition	expression	Set/Get	Exp. character string
122	Upper limit for judge condition	upperJudge	Set/Get	-999,999,999.9999 to 999,999,999.9999
123	Lower limit for judge condition	lowerJudge	Set/Get	-999,999,999.9999 to 999,999,999.9999
124	Save directory name	saveFolder	Set/Get	Character string
125	Prefix	prefix	Set/Get	Character string
130	Files in folder	fileCount	Set/Get	0 to 999
131	Image format	imageFormat	Set/Get	0: Bitmap, 1: Jpeg
132	Jpeg quality	jpegQuality	Set/Get	0 to 100
90,000	figure0 Count	figArea0_count	Set/Get	1
90,001	figure0 Type	figArea0_fig0_type	Set/Get	8: Rectangle
90,002	figure0 mode	figArea0_fig0_mode	Set/Get	0: OR
90,014	figure0 Rectangle Upper left position X	figArea0_fig0_box_X0	Set/Get	-99,999 to 99,999
90,015	figure0 Rectangle Upper left position Y	figArea0_fig0_box_Y0	Set/Get	-99,999 to 99,999
90,016	figure0 Rectangle Lower right position X	figArea0_fig0_box_X1	Set/Get	-99,999 to 99,999

No.	Data name	Data ident	Set/Get	Data range
90,017	figure0 Rectangle Lower right position Y	figAr- ea0_fig0_box_Y1	Set/Get	-99,999 to 99,999
90,099	figure0 Update	figArea0_update	Set only	1: Update

4-15 Data Logging

This processing item is not available in the FHV series.

This processing item is used to save measurement data in storage or a USB flash drive.

Used in the Following Case

When analyzing measurement data:

Logging is performed for measurement results and these are read into an external device such as a PC.

Example: Analysis using spreadsheet program statistical processing

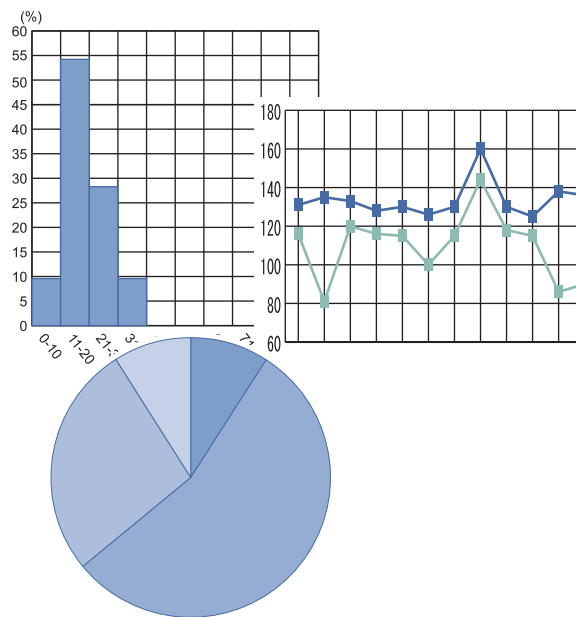

Precautions for Correct Use

- To use the *Data Logging* processing item, set the logging conditions by clicking **Tool** in the Main window- **System settings - Logging setting** in **Others - Data logging**.
- Insert the *Data Logging* processing item as close to the end of the measurement flow as possible. When *Only NG* is selected in the *Data Logging* setting, data will not be logged even if NG occurred hereafter the *Data Logging* processing unit in the measurement flow.
- When *Image logging* is also set to save images in the *Data Logging* setting, it is convenient that both measurement data and image data can be checked at once.
For details, refer to the *Performing Test Measurement/Starting Operation - Useful Functions for Operation - Logging Measurement Values and Measurement Images - Setting Logging Conditions Logging Setting* in the *Vision System FH/FHV Series User's Manual (Cat. No. Z365)*.

4-15-1 Settings (Data Logging)

Set the data to be logged. Up to 8 data can be logged with one *Data Logging* processing item.



Additional Information

If you want to perform logging for nine or more data as one record, refer to the *4-15-3 Additional Explanation (Data Logging)* on page 4-95.

- 1 In the Item tab area, click **Setting**.
- 2 In the list, click the *No.* for output to set an expression.
The selected *No.* for output is displayed under the list.

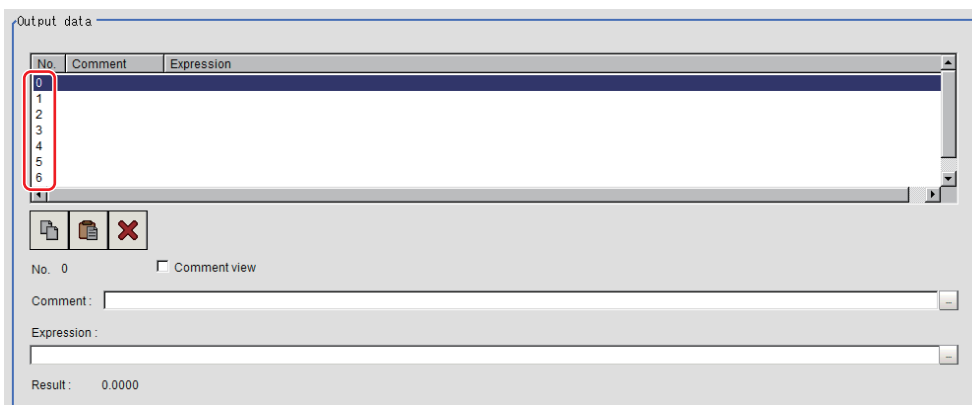

- 3 Click at the right end of the *Expression* text box and set the target data to be logged with the expression.
The *Setting expression* window is displayed.
- 4 Input comments in the *Comment* text box as necessary.
Multilingual is supported.
For details, refer to *Inputting Text* in the *Vision System FH/FHV Series User's Manual* (Cat. No. Z365).
- 5 Place a check to *Comment view* to display it in the **Detail Result Pane** area,
- 6 Repeat step 2 to 5 and set the data to each number for output.

4-15-2 Output Format (Data Logging)

Set the output format for logging data.

- 1 In the Item tab area, click **Output format**.
- 2 Set each item as necessary.

Output setting

File name :

Digits of integer : Digits

Digits of decimal : Digits

Measurement ID : Available None

Minus : - 8

0 suppress : Available None

Field separator :

Record separator :

Set comment as title

Setting item	Setting value [Factory default]	Description
File name	datalog.csv	Sets the file name with half-width alphanumeric characters. (Max. 128 characters) The number of characters is no more than 255 combining the folder and file names.
Digits of integer	1 to 10 [10]	Sets the digits of the integer part including the sign. For positive numbers, the plus symbol is not output. Ex.: Setting: 4 digits, Data: -5619 The output is -999.
Digits of decimal	0 to 4 [4]	Sets the digits of the decimal part. The least significant digit in the decimal part is rounded and output. When zero is set, the whole decimal part is rounded and output.
Measurement ID	<ul style="list-style-type: none"> [Available] None 	<p>Selects whether or not to output the measurement ID at the top of the output data.</p> <p>Measurement ID: Measurement time - YYYY-MM-DD_HH-MM-SSXXXX (YYYY: Calendar, MM: Month, DD: Day, HH: Hour, MM: Minute, SS: Second, XXXX: Millisecond combined with line numbers)</p> <p>Ex.: Measurement time: 11:10:25.500 A.M, December 24, 2007 and Line 0, in that case, the measurement ID will be <i>2007-12-24_11-10-25-5000</i>.</p> <p>Since the same measurement ID is applied to the image logging file name, both measurement and image data can be checked with the measurement ID.</p>
Minus	<ul style="list-style-type: none"> [-] 8 	For negative numbers, selects what symbol displays in the sign column.
0 suppress	<ul style="list-style-type: none"> Available [Non] 	<p>Selects the adjusting method when there are blank digits in the left of the output data.</p> <ul style="list-style-type: none"> Available: Fill the blank digits with 0. None: Fill the blank digits with space. <p>Ex.: Integer section setting: 5 digits Decimal section setting: 3 digits Data: 100.000 Available: 00100.000 None: __100.000 ("_" represents a space.)</p>

Setting item	Setting value [Factory default]	Description
Field separator	<ul style="list-style-type: none"> • OFF • [Comma] • Tab • Space • CR+LF 	Selects the separator between data for output.
Record separator	<ul style="list-style-type: none"> • OFF • Comma • Tab • Space • [CR+LF] 	Selects the separator between data groups for output.
Set comment as title	<ul style="list-style-type: none"> • Checked • [Unchecked] 	Place a check here when to output comments as a title on the first line of the data logging file.

3 Set the save destination of the logging data as necessary.

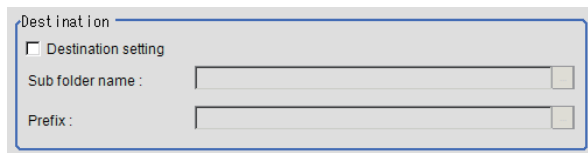

Setting item	Setting value [Factory default]	Description
Destination setting	<ul style="list-style-type: none"> • Checked • [Unchecked] 	Place a check here when setting the destination and the prefix.
Sub folder name	-	Specifies the subfolder name. The sub folder is generated as the save destination in the system logging settings. (Max. 32 characters) The following characters are not available for this. \\ : * ? " < >
Prefix	-	Specifies the prefix for the file name prefix to be saved. (Max. 32 characters) The following characters are not available for this. \\ : * ? " < >



Additional Information

- The actual data to be output is formatted as ASCII and the following header is added.

Measurement ID, Data1 Data N + delimiter

Measurement ID : measurement time YYYY-MM-DD_HH-MM-SS-XXXX

(YYYY: Calender, MM: Month, DD: Day, HH: Hour, MM: Minute, SS: Second, XXXX: Milliseconds combined with Line number)

- Ex.:

Measurement time: 11:10:25.500 A.M, December 24, 2007 and Line 0, in that case, the measurement ID will be 2007-12-24_11-10-25-5000.

- Logging timing and saving destination

For details, refer to the *Performing Test Measurement/Starting Operation - Useful Functions for Operation- Logging Measurement Values and Measurement Images* in the *Vision System FH/FHV Series User's Manual (Cat. No. Z365)*.

4-15-3 Additional Explanation (Data Logging)

When 9 or More Data Items Are Output as One Record

Up to 8 data can be output with one Data Logging processing item. When 9 or more data is output as one record, follow the procedure below.

- Register multiple *Data Logging* processing units in one scene. (*1)
- Set the same contents in the *File name* for the *Data Logging* processing units. (*2)
- Set as so that *Record separator (CR+LF)* is attached to the last output data. (*3)

Ex.:

In measurement for substrate arrangement, when outputting the coordinate data for 12 points acquired by two *Search* processing units as one record.

0. Camera Image Input
 1. Search
(Search position X, Y, Search angle TH, Reference SX, SY, Ref. Angle ST)
 2. Search
(Search position X, Y, Search angle TH, Reference SX, SY, Ref. Angle ST)
 3. Data logging
 4. Data logging
- (*1)
1 Set up more than "data logging" Unit in one scene

Output record:
 YYYY-MM-DD_HH-MM-SS-MS,X,Y,TH,SX,SY,ST,X,Y,TH,SX,SY,ST+CR+LF

└──────────┘ └──────────┘
 Data of Unit 1 Data of Unit 2

Unit 3 Data Logging setting details		Unit 4 Data Logging setting details		Remarks
<Condition setting>		<Condition setting>		
Output destination (file name)	datalog.csv	Output destination (file name)	datalog.csv	(*2) Make the path and file name the same.
Integer	8	Integer	8	
Decimal	3	Decimal	3	
Measurement ID	ON	Measurement ID	OFF	
Minus	-	Minus	-	
0 suppress	OFF	0 suppress	OFF	
Field separator	Comma	Field separator	Comma	
Record separator	Comma	Record separator	CR+LF	(*3) Set <i>Record separator (CR+LF)</i> in unit 4 containing the last data.
Set comment as title	Unchecked	Set comment as title	Unchecked	Do not check Set comment as title . Even if it is checked, comments for 9 or more data cannot be output correctly.
<Output data>		<Output data>		

Unit 3 Data Logging setting details	Unit 4 Data Logging setting details	Remarks
Calculation 0. U1.X (Search position X) Calculation 1. U1.Y (Search position Y) Calculation 2. U1.TH (Angle θ) Calculation 3. U1.SX (reference X) Calculation 4. U1.SX (reference Y) Calculation 5. U1.ST (Reference angle θ) Calculation 6. U2.X (Search position X) Calculation 7. U2.Y (Search position Y)	Calculation 0. U2.TH (Search angle θ) Calculation 0. U2.TH (Search angle θ) Calculation 1. U2.SX (reference X) Calculation 2. U2.SY (reference Y) Calculation 3. U2.ST (Reference angle θ)	The data not included in Unit 3 will be output as Calculation 0 to 3 in Unit 4

4-15-4 Measurement Results for Which Output Is Possible (Data Logging)

The following values can be output using processing items related to result output. It is also possible to reference measurement values from calculation expressions and other processing units.

Measurement items	Character string	Description
Judge	JG	Judgment results 0: No judgment (unmeasured) 1: Judgment result OK -1: Judgment result NG -10: Error (image format mismatch) -11: Error (unregistered model) -12: Error (insufficient memory) -20: Error (other errors)
Result of expression 0 to 7	D00 to 07	Expression result of expression 0 to 7

4-15-5 External Reference Tables (Data Logging)

No.	Data name	Data ident	Set/Get	Data range
0	Judge	judge	Get only	0: No judgment (unmeasured), 1: Judgment result OK, -1: Judgment result NG, -10: Error (image format mismatch), -11: Error (unregistered model), -12: Error (insufficient memory), -20: Error (other errors)
5+N (N=0 to 7)	Result of Expression	resultData0 to result-Data7	Get only	Calculation results of expressions
120	Measurement ID	measID	Set/Get	0: OFF, 1: ON
121	Integer	integerDigit	Set/Get	1 to 10
122	Decimal	decimalDigit	Set/Get	0: 0, 1: 1, 2: 2, 3: 3, 4: 4
123	Minus	minusNum	Set/Get	0: -, 1: 8

No.	Data name	Data ident	Set/Get	Data range
124	Field separator	fieldSeparator	Set/Get	0: OFF, 1: Comma, 2: Tab, 3: Space, 4: CR+LF
125	Record separator	recordSeparator	Set/Get	0: OFF, 1: Comma, 2: Tab, 3: Space, 4: CR+LF
126	0 suppress	zeroSuppress	Set/Get	0: OFF, 1: ON
127+N (N=0 to 7)	Comment	comment0 to comment7	Set/Get	Character string
135+N (N=0 to 7)	Expressions	setupData0 to setupData7	Set/Get	Exp. character string
143	File name	fileName	Set/Get	Character string
144	Sub directory name	saveDirectory	Set/Get	Character string
145	Prefix	prefix	Set/Get	Character string
146	Destination setting	destinationSet	Set/Get	0: Not setting, 1: Setting
147	Title output flag	titleOutputFlag	Set/Get	0: OFF, 1: ON
150+N (N=0 to 7)	Comment view	commentView0 to commentView7	Set/Get	0: OFF, 1: ON

4-16 Elapsed Time

Calculates the elapsed time in milliseconds after the measurement starts.
You can add this processing item to a scene and setup is not required.

Used in the Following Case

- When halting tmeasurement and branching to another process after the processing time exceeds a certain time:

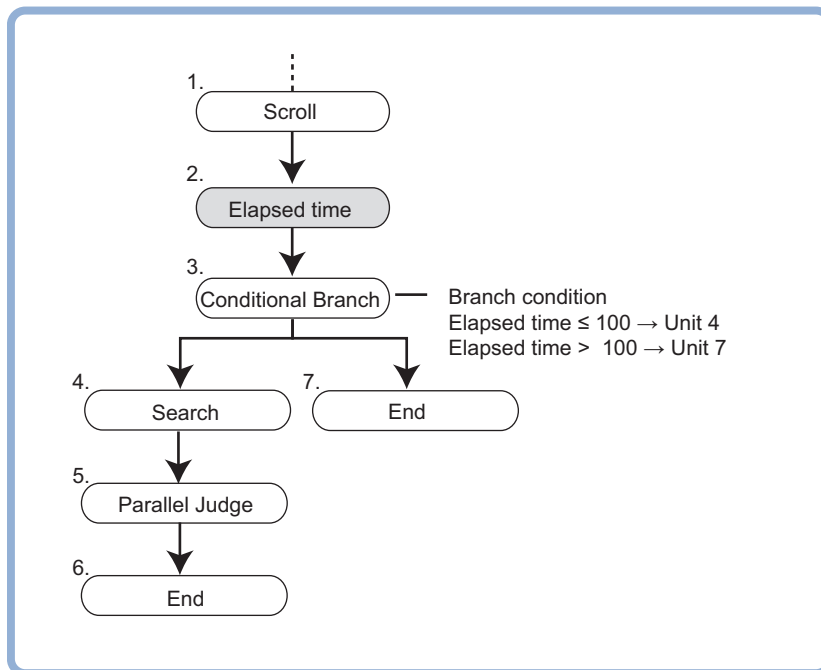

- When calculating the processing time of a unit:

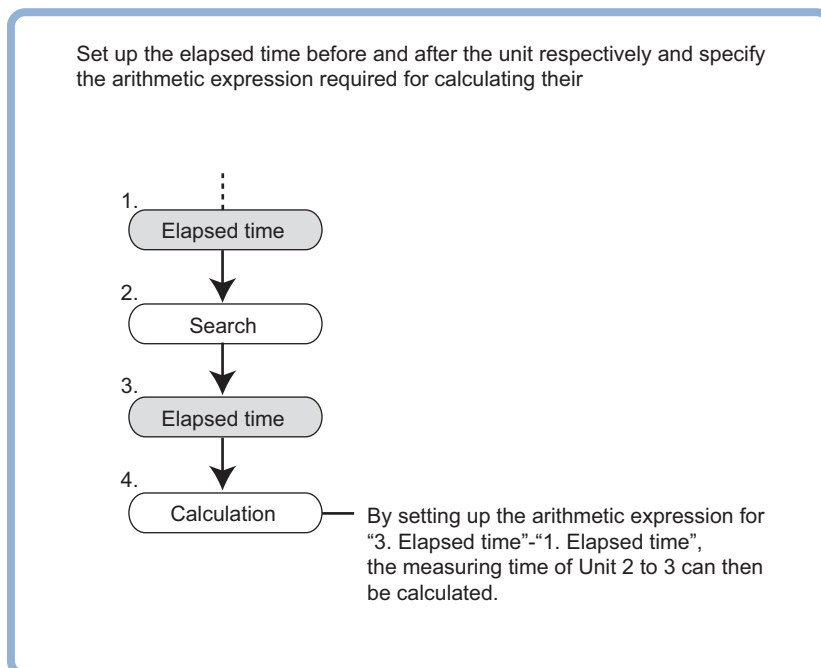



Additional Information

The elapsed time can be checked on the *Detail result* area in the Main window.

```
[11.Elapsed Time]
Judge : OK
Elapsed time : 33ms
```

4-16-1 Measurement Results for Which Output Is Possible (Elapsed Time)

The following values can be output using processing items related to result output. It is also possible to reference measurement values from calculation expressions and other processing units.

Measurement items	Character string	Description
Judge	JG	Judgment results 0: No judgment (unmeasured) 1: Judgment result OK -1: Judgment result NG -10: Error (image format mismatch) -11: Error (unregistered model) -12: Error (insufficient memory) -20: Error (other errors)
Elapsed Time	TM	Elapsed time from the beginning of measurement [ms]

4-16-2 External Reference Tables (Elapsed Time)

No.	Data name	Data ident	Set/Get	Data range
0	Judge	judge	Get only	0: No judgment (unmeasured), 1: Judgment result OK, -1: Judgment result NG, -10: Error (image format mismatch), -11: Error (unregistered model), -12: Error (insufficient memory), -20: Error (other errors)
5	Elapsed Time	elapsedTime	Get only	0 to 999,999 [ms]

4-17 Wait

Used in the Following Case

When halting processing in the measurement flow temporarily for a specified time.

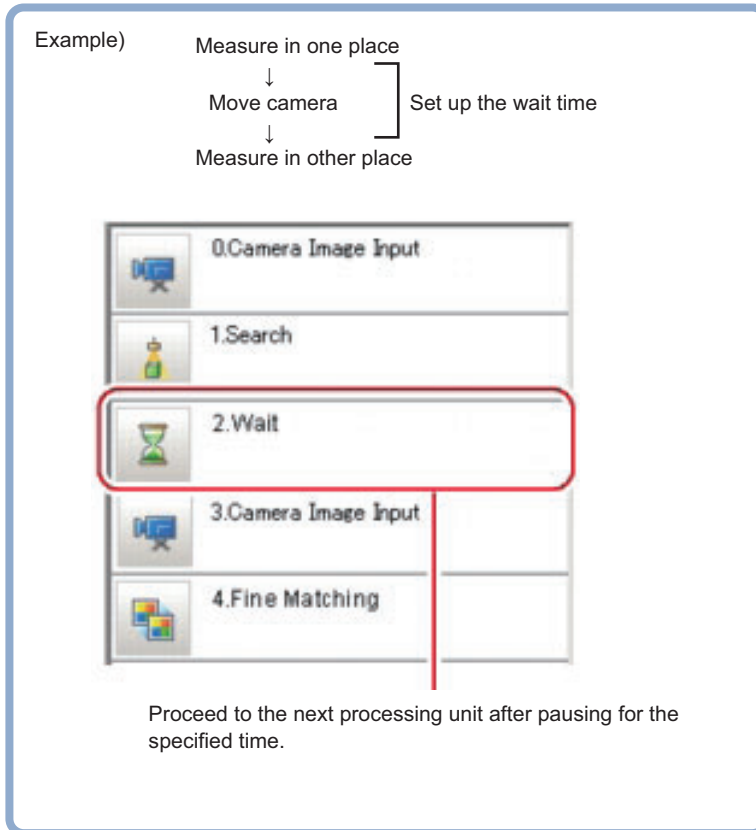

4-17-1 Settings (Wait)

- 1 Specify the time period to halt the measurement flow in the *Waiting time* area.

Unit: ms

Range: 0 to 9,999

Waiting time

Setting time : ms

- 2 Click **OK**.
The settings are completed.

4-17-2 External Reference Tables (Wait)

No.	Data name	Data ident	Set/Get	Data range
120	Waiting time	waitingTime	Set/Get	0 to 9,999 [ms]

4-18 Focus

This processing item is not available in the FHV series.
This processing item helps you bring the camera into focus.

Used in the Following Case

When adjusting input images that are easily out of focus

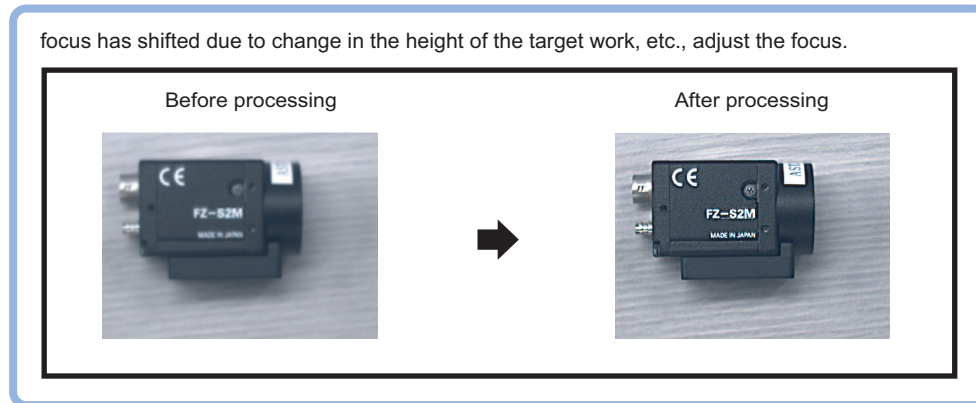

Precautions for Correct Use

Processing is different for color images and monochrome images. When the camera type used in the previous setup was changed to color or monochrome type, perform the settings again.

4-18-1 Measurement Parameters (Focus)

When focus values is unstable, change measurement parameters as necessary.

- 1** In the Item tab area, click **Measurement**.
- 2** In the *Display* area, click **Change display** to switch between camera image types.

Setting item	Setting value [Factory default]	Description
Display	<ul style="list-style-type: none"> • Through image • [Freeze image] 	<ul style="list-style-type: none"> • Through image: The latest image is always loaded from the camera and displayed. • Freeze image: The image loaded in the immediately preceding measurement is displayed.

- 3** Set the focus value.
The focus value is chronologically displayed in real time in the *Focus setting graph* area

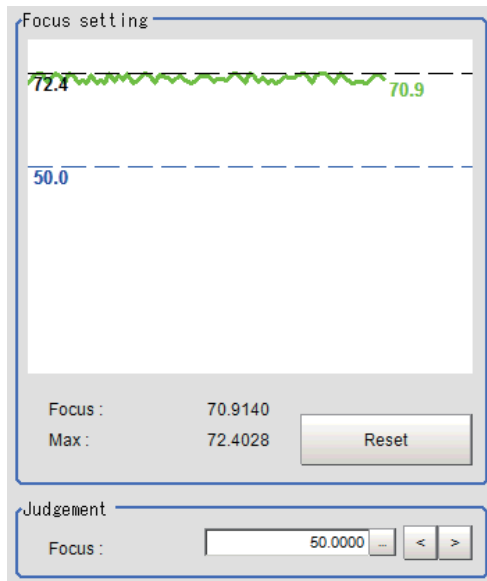

4 Set the judgment condition.

Setting item	Setting value [Factory default]	Description
Focus	0.0000 to 255.0000 [50.0000]	Sets the judgment value for focus.

4-18-2 Region Setting (Focus)

Set the range to adjust Focus.

- 1 In the Item tab area, click **Region setting**.
- 2 Click **Edit**.
The *Figure setting* area is displayed.
- 3 Set the range to adjust Focus.
As a rectangle to cover the whole screen is set, adjust the size and position of it.
- 4 In the *Figure setting* area, click **OK**.
 - **OK**: Changes the settings and returns to the previous menu.
 - **Cancel**: Changes are discarded and returns to the previous menu.
 - **Apply**: Updates the settings without leaving the current window.

4-18-3 Output parameter (Focus)

Select whether or not to reflect the judgment results of this processing unit to the overall judgment of the scene.

- 1 In the Item tab area, click **Output parameter**.

- 2** Select whether or not to reflect it to the overall judgment in *Reflect to overall judgement* area.

Setting item	Setting value [Factory default]	Description
Reflect to overall judgment	<ul style="list-style-type: none"> • [ON] • OFF 	Enables choosing whether or not the judgement results of this processing unit is reflected in the scene overall judgment.

4-18-4 Key Points for Test Measurement and Adjustment (Focus)

The following content is displayed in the *Detail result* area as text.

Displayed item	Description
Judge	Judgment results 0: No judgment (unmeasured) 1: Judgment result OK -1: Judgment result NG -10: Error (image format mismatch) -11: Error (unregistered model) -12: Error (insufficient memory) -20: Error (other errors)
Focus	Focus value

4-18-5 External Reference Tables (Focus)

No.	Data name	Data ident	Set/Get	Data range
0	Judge	judge	Get only	0: No judgment (unmeasured), 1: Judgment result OK, -1: Judgment result NG, -10: Error (image format mismatch), -11: Error (unregistered model), -12: Error (insufficient memory), -20: Error (other errors)
1	Focus value	focusValue	Get only	-
2	Focus Max.	focusValueMax	Get only	-
3	History of focus	recentFocusValue	Get only	-
103	Reflect to overall judgement	overallJudge	Set/Get	0: ON, 1: OFF
120	Focus Min.	lowerFocus	Set/Get	0.0 to 255.0
6,002	Format	cameraColor	Set/Get	1: Monochrome camera 2: Color camera
90,000	figure0 Count	figArea0_count	Set/Get	0 to 8
90,001	figure0 Type	figArea0_fig0_type	Set/Get	8: Rectangle, 16: Ellipse, 64: Circumference, 512: Polygon
90,002	figure0 mode	figArea0_fig0_mode	Set/Get	0: OR, 1: NOT
90,014	figure0 Rectangle Upper left position X	figArea0_fig0_box_X0	Set/Get	-99,999 to 99,999
90,015	figure0 Rectangle Upper left position Y	figArea0_fig0_box_Y0	Set/Get	-99,999 to 99,999

No.	Data name	Data ident	Set/Get	Data range
90,016	figure0 Rectangle Lower right position X	figArea0_fig0_box_X1	Set/Get	-99,999 to 99,999
90,017	figure0 Rectangle Lower right position Y	figArea0_fig0_box_Y1	Set/Get	-99,999 to 99,999
90,018	figure0 Ellipse Center Position X	figArea0_fig0_ellipse_CX	Set/Get	-99,999 to 99,999
90,019	figure0 Ellipse Center Position Y	figArea0_fig0_ellipse_CY	Set/Get	-99,999 to 99,999
90,020	figure0 Ellipse RadiusX	figArea0_fig0_ellipse_RX	Set/Get	1 to 99,999
90,021	figure0 Ellipse RadiusY	figArea0_fig0_ellipse_RY	Set/Get	1 to 99,999
90,025	figure0 Circumference Center Position X	figArea0_fig0_circleW_X	Set/Get	-99,999 to 99,999
90,026	figure0 Circumference Center Position Y	figArea0_fig0_circleW_Y	Set/Get	-99,999 to 99,999
90,027	figure0 Circumference Radius	figArea0_fig0_circleW_R	Set/Get	0 to 99,999
90,028	figure0 Circumference Width	figArea0_fig0_circleW_W	Set/Get	0 to 99,999
90,040	figure0 Polygon Point Count	figArea0_fig0_polygon_count	Set/Get	3 to 10
90,041	figure0 Polygon Point1 Position X	figArea0_fig0_polygon_x0	Set/Get	-99,999 to 99,999
90,042	figure0 Polygon Point1 Position Y	figArea0_fig0_polygon_y0	Set/Get	-99,999 to 99,999
90,043	figure0 Polygon Point2 Position X	figArea0_fig0_polygon_x1	Set/Get	-99,999 to 99,999
90,044	figure0 Polygon Point2 Position Y	figArea0_fig0_polygon_y1	Set/Get	-99,999 to 99,999
90,045	figure0 Polygon Point3 Position X	figArea0_fig0_polygon_x2	Set/Get	-99,999 to 99,999
90,046	figure0 Polygon Point3 Position Y	figArea0_fig0_polygon_y2	Set/Get	-99,999 to 99,999
90,047	figure0 Polygon Point4 Position X	figArea0_fig0_polygon_x3	Set/Get	-99,999 to 99,999
90,048	figure0 Polygon Point4 Position Y	figArea0_fig0_polygon_y3	Set/Get	-99,999 to 99,999
90,049	figure0 Polygon Point5 Position X	figArea0_fig0_polygon_x4	Set/Get	-99,999 to 99,999
90,050	figure0 Polygon Point5 Position Y	figArea0_fig0_polygon_y4	Set/Get	-99,999 to 99,999
90,051	figure0 Polygon Point6 Position X	figArea0_fig0_polygon_x5	Set/Get	-99,999 to 99,999
90,052	figure0 Polygon Point6 Position Y	figArea0_fig0_polygon_y5	Set/Get	-99,999 to 99,999

No.	Data name	Data ident	Set/Get	Data range
90,053	figure0 Polygon Point7 Position X	figArea0_fig0_polygon_x6	Set/Get	-99,999 to 99,999
90,054	figure0 Polygon Point7 Position Y	figArea0_fig0_polygon_y6	Set/Get	-99,999 to 99,999
90,055	figure0 Polygon Point8 Position X	figArea0_fig0_polygon_x7	Set/Get	-99,999 to 99,999
90,056	figure0 Polygon Point8 Position Y	figArea0_fig0_polygon_y7	Set/Get	-99,999 to 99,999
90,057	figure0 Polygon Point9 Position X	figArea0_fig0_polygon_x8	Set/Get	-99,999 to 99,999
90,058	figure0 Polygon Point9 Position Y	figArea0_fig0_polygon_y8	Set/Get	-99,999 to 99,999
90,059	figure0 Polygon Point10 Position X	figArea0_fig0_polygon_x9	Set/Get	-99,999 to 99,999
90,060	figure0 Polygon Point10 Position Y	figArea0_fig0_polygon_y9	Set/Get	-99,999 to 99,999
90,099	figure0 Update	figArea0_update	Set only	1: Update
90,101	figure1 Type	figArea0_fig1_type	Set/Get	8: Rectangle, 16: Ellipse, 64: Circumference, 512: Polygon
:	:	:	:	:
90,201	figure2 Type	figArea0_fig2_type	Set/Get	8: Rectangle, 16: Ellipse, 64: Circumference, 512: Polygon
:	:	:	:	:
90,301	figure3 Type	figArea0_fig3_type	Set/Get	8: Rectangle, 16: Ellipse, 64: Circumference, 512: Polygon
:	:	:	:	:
90,401	figure4 Type	figArea0_fig4_type	Set/Get	8: Rectangle, 16: Ellipse, 64: Circumference, 512: Polygon
:	:	:	:	:
90,501	figure5 Type	figArea0_fig5_type	Set/Get	8: Rectangle, 16: Ellipse, 64: Circumference, 512: Polygon
:	:	:	:	:
90,601	figure6 Type	figArea0_fig6_type	Set/Get	8: Rectangle, 16: Ellipse, 64: Circumference, 512: Polygon
:	:	:	:	:
90,701	figure7 Type	figArea0_fig7_type	Set/Get	8: Rectangle, 16: Ellipse, 64: Circumference, 512: Polygon
:	:	:	:	:
90,760	figure7 Polygon Point10 Position Y	figArea0_fig7_polygon_y9	Set/Get	-99,999 to 99,999

4-19 Iris

This processing item is not available in the FHV series.

This function assists the aperture operation to adjust the amount of light taken in by the camera according to the change in illumination intensity.

Used in the Following Case

When brightness is unstable in the measurement site

Operate the iris so that input images of low brightness can be inspected with ease.



Precautions for Correct Use

Processing is different for color images and monochrome images. When the camera type used in the previous setup was changed to color or monochrome type, perform the settings again.

4-19-1 Measurement Parameters (Iris)

Adjust the amount of light to be acquired through lens. Change measurement parameters as necessary.

- 1 In the Item tab area, click **Measurement**.
- 2 In the *Display* area, click **Change display** to switch between camera image types. (In the setting window, re-measurement images are not displayed.)

Setting item	Setting value [Factory default]	Description
Display	<ul style="list-style-type: none"> • Through image • [Freeze image] 	<ul style="list-style-type: none"> • Through image: The latest image is always loaded from the camera and displayed. • Freeze image: The image loaded in the immediately preceding measurement is displayed.

- 3 Set the valid brightness range.
In the *Iris setting graph* area, the valid pixels are chronologically displayed in real time.

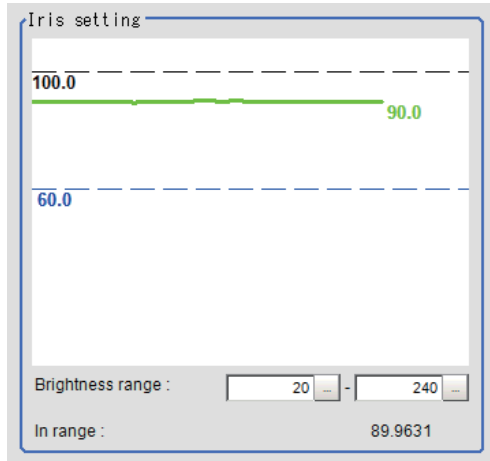

Setting item	Setting value [Factory default]	Description
Brightness range	0 to 255 [20] to [240]	Sets the range to judge whether or not the brightness of pixels is valid.

4 Set the judgment condition.

- For color cameras:

Setting item	Setting value [Factory default]	Description
In range	0.0000 to 100.0000 [60.0000]	Sets the minimum number of pixels to be made valid. Valid pixels indicate the percentage (%) of pixels inside the valid brightness range in the region.
R average	0 to 255 [0.000] to [255.000]	
G average	0 to 255 [0.000] to [255.000]	
B average	0 to 255 [0.000] to [255.000]	

- For monochrome cameras:

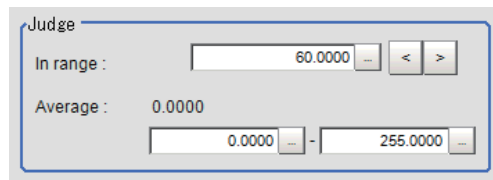

Setting item	Setting value [Factory default]	Description
In range	0.0000 to 100.0000 [60.0000]	Sets the minimum number of pixels to be made valid. Valid pixels indicate the percentage (%) of pixels inside the valid brightness range in the region.
Average	0 to 255 [0.000] to [255.000]	Sets the average brightness range to be made valid.

4-19-2 Region Setting (Iris)

Set the range to adjust Iris.

- 1** In the Item tab area, click **Region setting**.
- 2** Click **Edit**.
The *Figure setting* area is displayed.
- 3** Set the range to adjust Iris.
As a rectangle to cover the whole screen is set, adjust the size and position of it.
- 4** In the *Figure setting* area, click **OK**.
 - **OK**: Changes the settings and returns to the previous menu.
 - **Cancel**: Changes are discarded and returns to the previous menu.
 - **Apply**: Updates the settings without leaving the current window.

4-19-3 Output parameter (Iris)

Select whether or not to reflect the judgment results of this processing unit to the overall judgment of the scene.

- 1** In the Item tab area, click **Output parameter**.
- 2** Select whether or not to reflect it to the overall judgment in *Reflect to overall judgement* area.

Setting item	Setting value [Factory default]	Description
Reflect to overall judgment	<ul style="list-style-type: none"> • [ON] • OFF 	Enables choosing whether or not the judgement results of this processing unit is reflected in the scene overall judgment.

4-19-4 Key Points for Test Measurement and Adjustment (Iris)

The following content is displayed in the *Detail result* area as text.

Displayed item	Description
Judge	Judgment results 0: No judgment (unmeasured) 1: Judgment result OK -1: Judgment result NG -10: Error (image format mismatch) -11: Error (unregistered model) -12: Error (insufficient memory) -20: Error (other errors)
In range	Proportion for the inside of the valid brightness range
R average	R average in the region
G average	G average in the region
B average	B average in the region

4-19-5 External Reference Tables (Iris)

No.	Data name	Data ident	Set/Get	Data range
0	Judge	judge	Get only	0: No judgment (unmeasured), 1: Judgment result OK, -1: Judgment result NG, -10: Error (image format mismatch), -11: Error (unregistered model), -12: Error (insufficient memory), -20: Error (other errors)
1	Count	count	Get only	0 to 100
2	Average	average	Get only	0 to 255
3	Average R component value	averageR	Get only	0 to 255
4	Average G component value	averageG	Get only	0 to 255
5	Average B component value	averageB	Get only	0 to 255
6	Recent count	recentCount	Get only	-
7	Recent average	recentAverage	Get only	-
8	Recent average R	recentAverageR	Get only	-
9	Recent average G	recentAverageG	Get only	-
10	Recent average B	recentAverageB	Get only	-
103	Reflect to overall judgement	overallJudge	Set/Get	0: ON 1: OFF
120	Brightness range Min.	minBright	Set/Get	0 to 255
121	Brightness range Max.	maxBright	Set/Get	0 to 255
122	In range Min.	lowerCount	Set/Get	0 to 100
123	Average Min.	lowerAverage	Set/Get	0.0 to 255.0
124	Average Max.	upperAverage	Set/Get	0.0 to 255.0
125	R average Min.	lowerAverageR	Set/Get	0.0 to 255.0
126	R average Max.	upperAverageR	Set/Get	0.0 to 255.0
127	G average Min.	lowerAverageG	Set/Get	0.0 to 255.0
128	G average Max.	upperAverageG	Set/Get	0.0 to 255.0
129	B average Min.	lowerAverageB	Set/Get	0.0 to 255.0
130	B average Max.	upperAverageB	Set/Get	0.0 to 255.0
6,002	Format	cameraColor	Set/Get	1: Monochrome camera 2: Color camera
90,000	figure0 Count	figArea0_count	Set/Get	0 to 8
90,001	figure0 Type	figArea0_fig0_type	Set/Get	8: Rectangle, 16: Ellipse, 64: Circumference, 512: Polygon
90,002	figure0 mode	figArea0_fig0_mode	Set/Get	0: OR 1: NOT
90,014	figure0 Rectangle Upper left position X	figArea0_fig0_box_X0	Set/Get	-99,999 to 99,999
90,015	figure0 Rectangle Upper left position Y	figArea0_fig0_box_Y0	Set/Get	-99,999 to 99,999

No.	Data name	Data ident	Set/Get	Data range
90,016	figure0 Rectangle Lower right position X	figArea0_fig0_box_X1	Set/Get	-99,999 to 99,999
90,017	figure0 Rectangle Lower right position Y	figArea0_fig0_box_Y1	Set/Get	-99,999 to 99,999
90,018	figure0 Ellipse Center Position X	figArea0_fig0_ellipse_CX	Set/Get	-99,999 to 99,999
90,019	figure0 Ellipse Center Position Y	figArea0_fig0_ellipse_CY	Set/Get	-99,999 to 99,999
90,020	figure0 Ellipse RadiusX	figArea0_fig0_ellipse_RX	Set/Get	1 to 99,999
90,021	figure0 Ellipse RadiusY	figArea0_fig0_ellipse_RY	Set/Get	1 to 99,999
90,025	figure0 Circumference Center Position X	figArea0_fig0_circleW_X	Set/Get	-99,999 to 99,999
90,026	figure0 Circumference Center Position Y	figArea0_fig0_circleW_Y	Set/Get	-99,999 to 99,999
90,027	figure0 Circumference Radius	figArea0_fig0_circleW_R	Set/Get	0 to 99,999
90,028	figure0 Circumference Width	figArea0_fig0_circleW_W	Set/Get	0 to 99,999
90,040	figure0 Polygon Point Count	figArea0_fig0_polygon_count	Set/Get	3 to 10
90,041	figure0 Polygon Point1 Position X	figArea0_fig0_polygon_x0	Set/Get	-99,999 to 99,999
90,042	figure0 Polygon Point1 Position Y	figArea0_fig0_polygon_y0	Set/Get	-99,999 to 99,999
90,043	figure0 Polygon Point2 Position X	figArea0_fig0_polygon_x1	Set/Get	-99,999 to 99,999
90,044	figure0 Polygon Point2 Position Y	figArea0_fig0_polygon_y1	Set/Get	-99,999 to 99,999
90,045	figure0 Polygon Point3 Position X	figArea0_fig0_polygon_x2	Set/Get	-99,999 to 99,999
90,046	figure0 Polygon Point3 Position Y	figArea0_fig0_polygon_y2	Set/Get	-99,999 to 99,999
90,047	figure0 Polygon Point4 Position X	figArea0_fig0_polygon_x3	Set/Get	-99,999 to 99,999
90,048	figure0 Polygon Point4 Position Y	figArea0_fig0_polygon_y3	Set/Get	-99,999 to 99,999
90,049	figure0 Polygon Point5 Position X	figArea0_fig0_polygon_x4	Set/Get	-99,999 to 99,999
90,050	figure0 Polygon Point5 Position Y	figArea0_fig0_polygon_y4	Set/Get	-99,999 to 99,999
90,051	figure0 Polygon Point6 Position X	figArea0_fig0_polygon_x5	Set/Get	-99,999 to 99,999
90,052	figure0 Polygon Point6 Position Y	figArea0_fig0_polygon_y5	Set/Get	-99,999 to 99,999

No.	Data name	Data ident	Set/Get	Data range
90,053	figure0 Polygon Point7 Position X	figArea0_fig0_polygon_x6	Set/Get	-99,999 to 99,999
90,054	figure0 Polygon Point7 Position Y	figArea0_fig0_polygon_y6	Set/Get	-99,999 to 99,999
90,055	figure0 Polygon Point8 Position X	figArea0_fig0_polygon_x7	Set/Get	-99,999 to 99,999
90,056	figure0 Polygon Point8 Position Y	figArea0_fig0_polygon_y7	Set/Get	-99,999 to 99,999
90,057	figure0 Polygon Point9 Position X	figArea0_fig0_polygon_x8	Set/Get	-99,999 to 99,999
90,058	figure0 Polygon Point9 Position Y	figArea0_fig0_polygon_y8	Set/Get	-99,999 to 99,999
90,059	figure0 Polygon Point10 Position X	figArea0_fig0_polygon_x9	Set/Get	-99,999 to 99,999
90,060	figure0 Polygon Point10 Position Y	figArea0_fig0_polygon_y9	Set/Get	-99,999 to 99,999
90,099	figure0 Update	figArea0_update	Set only	1: Update
90,101	figure1 Type	figArea0_fig1_type	Set/Get	8: Rectangle, 16: Ellipse, 64: Circumference, 512: Polygon
:	:	:	:	:
90,201	figure2 Type	figArea0_fig2_type	Set/Get	8: Rectangle, 16: Ellipse, 64: Circumference, 512: Polygon
:	:	:	:	:
90,301	figure3 Type	figArea0_fig3_type	Set/Get	8: Rectangle, 16: Ellipse, 64: Circumference, 512: Polygon
:	:	:	:	:
90,401	figure4 Type	figArea0_fig4_type	Set/Get	8: Rectangle, 16: Ellipse, 64: Circumference, 512: Polygon
:	:	:	:	:
90,501	figure5 Type	figArea0_fig5_type	Set/Get	8: Rectangle, 16: Ellipse, 64: Circumference, 512: Polygon
:	:	:	:	:
90,601	figure6 Type	figArea0_fig6_type	Set/Get	8: Rectangle, 16: Ellipse, 64: Circumference, 512: Polygon
:	:	:	:	:
90,701	figure7 Type	figArea0_fig7_type	Set/Get	8: Rectangle, 16: Ellipse, 64: Circumference, 512: Polygon
:	:	:	:	:
90,760	figure7 Polygon Point10 Position Y	figArea0_fig7_polygon_y9	Set/Get	-99,999 to 99,999

4-20 Parallelize

The measurement time can be reduced by dividing one part of the measurement flow to two or more tasks and processing each one in parallel.

Measurement processing of the processing unit can be done in parallel when the operation mode's parallel processing is ON. When the parallel processing is OFF, measurement processing of the processing unit is processed in series according to the execution order of the measurement flow.

You can add this processing item to a scene without any settings. Place it at the beginning of the process that you want to run in parallel.

Parallel processing, parallel processing tasks, and parallel processing end cannot be used separately. Make sure to use them together as a set.

For details, refer to *Parallel Processing* in the *Vision Sensor FH/FHV Series Vision System User's Manual (Cat. No. Z365)*.

Used in the Following Case

When you want to reduce the overall processing time when there are multiple measurement processing items in the measurement flow.

Ex.: Reducing the overall processing time, instead of performing series processing, by processing multiple searches in parallel.

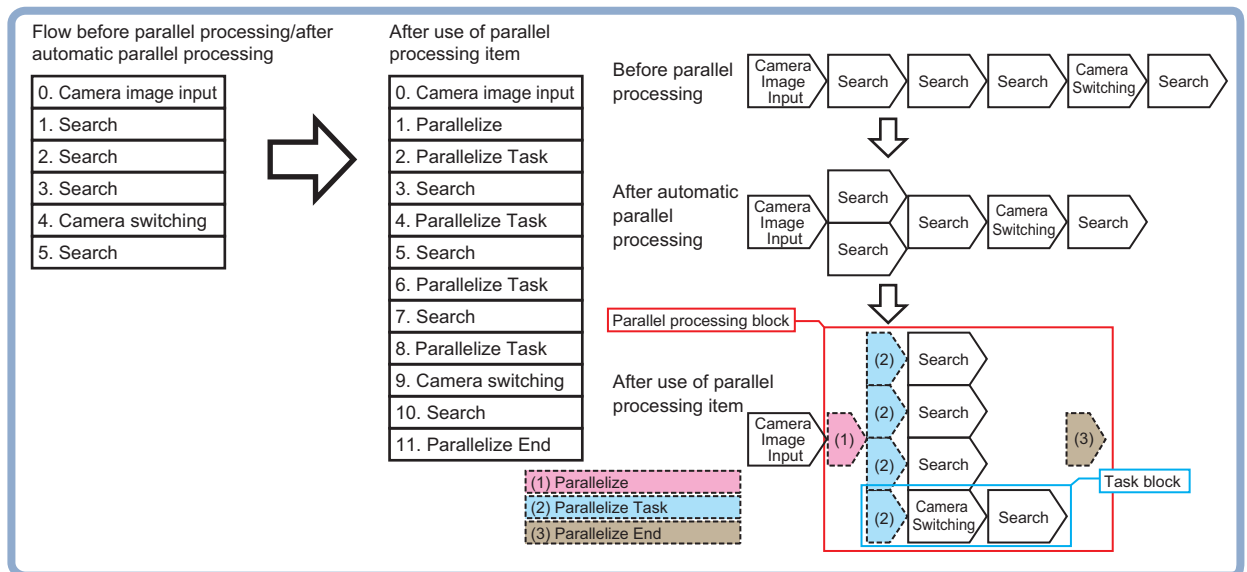

Processing units can be executed in parallel by properly combining parallel processing, parallel processing tasks, and parallel processing end.

4-21 Parallelize Task

The measurement time can be reduced by dividing one part of the measurement flow to two or more tasks and processing each one in parallel.

Measurement processing of the processing unit can be done in parallel when the operation mode's parallel processing is ON. When the parallel processing is OFF, measurement processing of the processing unit is processed in series according to the execution order of the measurement flow.

You can add this processing item to a scene without any settings. Place it at the beginning of the process that you want to run in parallel.

Parallel processing, parallel processing tasks, and parallel processing end cannot be used separately. Make sure to use them together as a set.

For details, refer to *Parallel Processing* in the *Vision Sensor FH/FHV Series Vision System User's Manual (Cat. No. Z365)*.

Used in the Following Case

When you want to reduce the overall processing time when there are multiple measurement processing items in the measurement flow.

Ex.: Reducing the overall processing time, instead of performing series processing, by processing multiple searches in parallel.

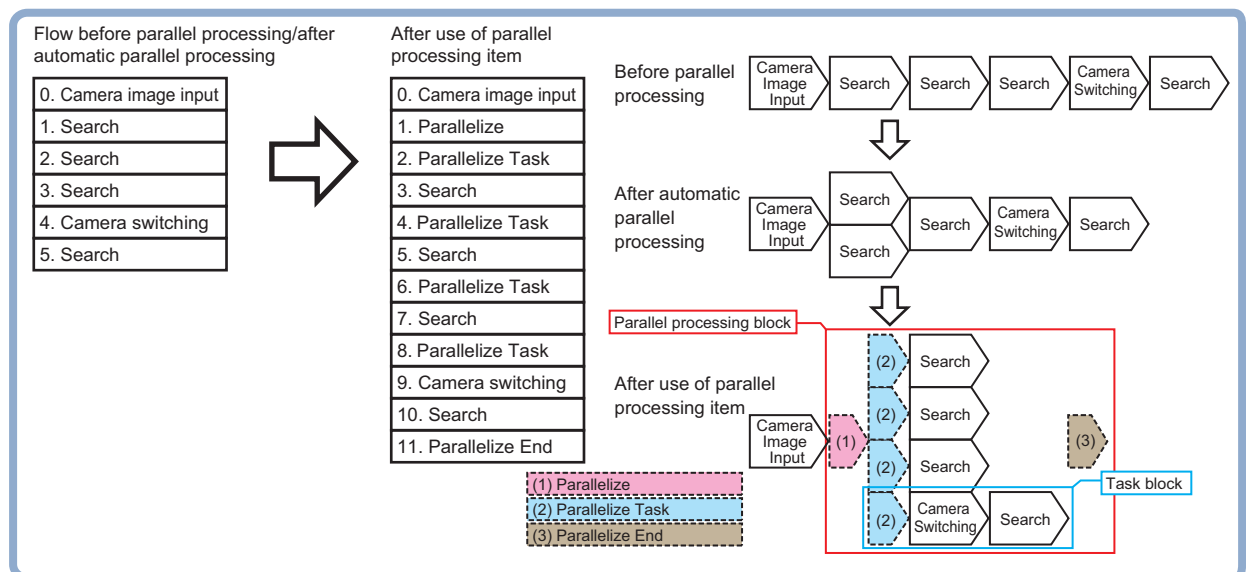

Processing units can be executed in parallel by properly combining parallel processing, parallel processing tasks, and parallel processing end.

4-22 Statistics

To reduce measurement variation of a given measurement processing item, multiple measurement results are stored in the processing item and the average value is calculated at a specified timing. Up to 8 target data per processing item can be set.

Used in the Following Case

When you want to use an average of multiple measurement results as the measurement value because the workpiece is vibrating

4-22-1 Settings Flow (Statistics)

To set Statistics, follow the steps below.

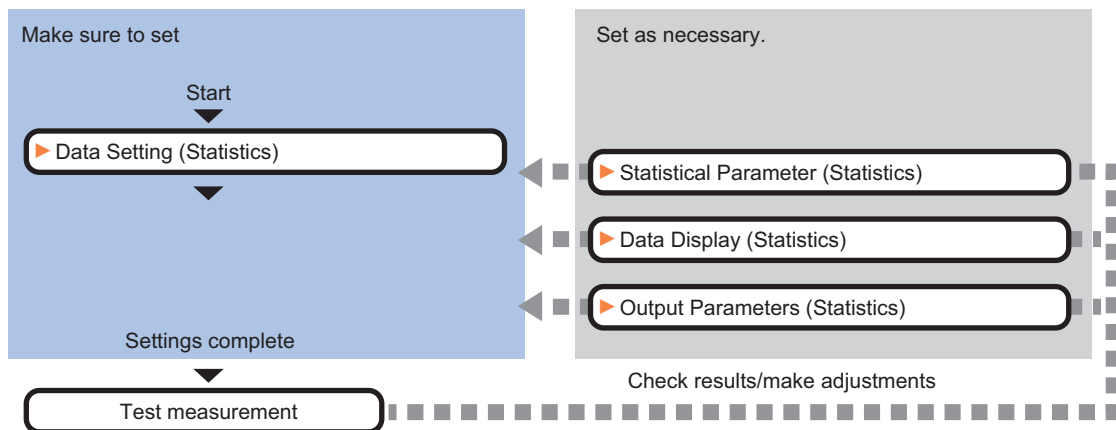

List of Statistics Items

Item	Description
Statistical parameter	Sets the number of data to be stored as well as processing timing. <i>4-22-2 Statistical Parameters (Statistics) on page 4-114</i>
Data setting	Sets the data to be processed using an expression. <i>4-22-3 Data Setting (Statistics) on page 4-115</i>
Data display	Sets for checking of stored data with a graph. <i>4-22-4 Data Display (Statistics) on page 4-116</i>
Output parameter	This item is changed as necessary. Normally, the factory default value will be used. <i>4-22-5 Output Parameters (Statistics) on page 4-118</i>

4-22-2 Statistical Parameters (Statistics)

Set the number of data to be stored as well as processing timing. The greater the number of data held, the less the measurement variation becomes.

- 1 In the Item tab area, click **Statistical parameter**.

- 2** In the *Max. data count* area, set the maximum number of data to be stored.

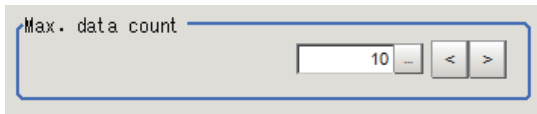

Setting item	Setting value [Factory default]	Description
Max. data count	1 to 100 [10]	Sets the number of data to be saved to one processing target data.

- 3** In the *Calculate timing* area, set the timing of statistical processing to perform.

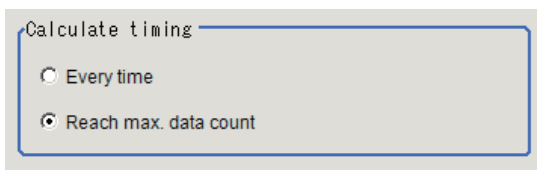

Setting item	Setting value [Factory default]	Description
Calculate timing	<ul style="list-style-type: none"> • Every time • [Reach max. data count] 	<p>Selects the timing to perform the data processing.</p> <ul style="list-style-type: none"> • Every time: Calculates the average value of stored data per measurement. • Reach max. data count: Calculates the average value only when the stored data reached to the number specified in <i>Reach max. data count</i>. If the maximum number of saved items is exceeded, the saved accumulated data is cleared.

- 4** Click **OK**.

4-22-3 Data Setting (Statistics)

Set the target data using a calculation expression. Up to 8 data can be set.

- 1** In the Item tab area, click **Data setting**.
- 2** In the *Data setting* area, set each item.
Up to 8 data can be set.

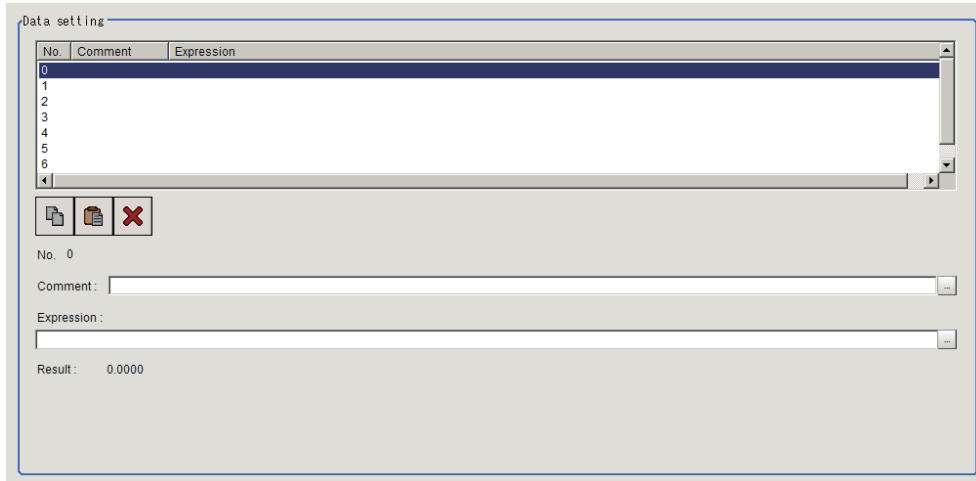

Setting item	Setting value [Factory default]	Description
Comment	-	Sets comments describing the expression used for data to be processed. Multilingual is also supported. For details, refer to <i>Inputting Text</i> in the <i>Vision System FH/FHV Series User's Manual (Cat. No. Z365)</i> .
Expression	-	Sets the expression used for data to be processed.

- Place a check to *Comment view* to display it in the **Detail Result Pane** area,

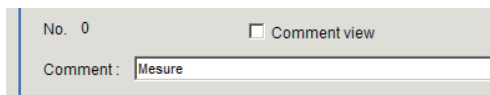

4-22-4 Data Display (Statistics)

Set that stored data is checked with a graph. Also, set the judgement range while checking the graph. Data outside the judgement range will not be processed.

- In the Item Tab area, click **Data display**.
- In the *Data display* area, set the data number to be targeted for *Data setting*.

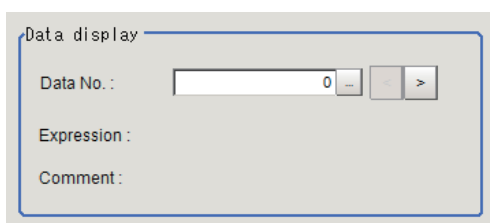

Setting item	Setting value [Factory default]	Description
Data No.	0 to 7 [0]	Sets the data number to be targeted for the data setting.
Expression	-	Displays the setting data for the expression corresponding to the data number.

Setting item	Setting value [Factory default]	Description
Comment	-	Displays the setting data for the comments corresponding to the data number.

- 3** In the *Change display range* area, set the upper and lower limit values for graph display range. After measuring objects several times, opening this window and clicking **Default**, a display range optimized for the measurement values is automatically set.

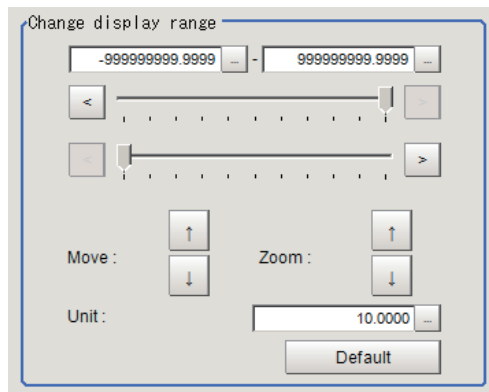

Setting item	Setting value [Factory default]	Description
Upper and lower limit values of the graph display range	-999,999,999.9999 to 999,999,999.9999	Sets the upper and lower limit values for the display range of the graph corresponding to the data number.
Unit	1.0000 to 1,000,000.0000[10.0000]	Sets the change amount of the value when clicking up/down arrows for <i>Move</i> or <i>Zoom</i> .

- 4** In the *Judgment* area, set the upper and lower limit values for the judgment range of the set data. After measuring objects several times, opening this window and clicking **Default**, a display range optimized for the measurement values is automatically set.

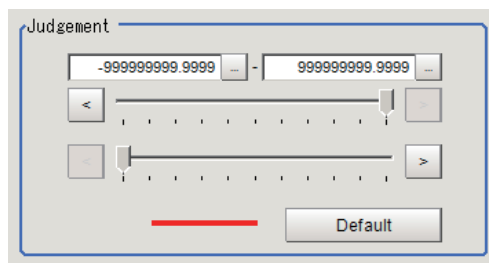

Setting item	Setting value [Factory default]	Description
Upper and lower limit values of the judgment range	-999,999,999.9999 to 999,999,999.9999	Sets the upper and lower limit values for the judgment range corresponding to the data number.

- 5** The value reflecting the setting changes is displayed in the *Data information* area.

Data information	
Max. :	0.0000
Min. :	0.0000
Valid data count :	0

4-22-5 Output Parameters (Statistics)

Select how to handle the coordinates to be output to the external device as measurement results. This item can be changed as necessary. Normally, the factory default value will be used.

- 1 In the Item tab area, click **Output parameter**.
- 2 Select the *Reflect to overall judgment*.

Setting item	Setting value [Factory default]	Description
Reflect to overall judgment	<ul style="list-style-type: none"> • [ON] • OFF 	Enables choosing whether or not the judgement results of this processing unit is reflected in the scene overall judgment.

4-22-6 Key Points for Test Measurement and Adjustment (Statistics)

The following content is displayed in the *Detail result* area as text.

Displayed item	Description
Judge	Judgment results 0: No judgment (unmeasured) 1: Judgment result OK -1: Judgment result NG -10: Error (image format mismatch) -11: Error (unregistered model) -12: Error (insufficient memory) -20: Error (other errors)
No. of measurements	Stored number of times
Statistical result 0	The average value of data 0
Statistical result 1	The average value of data 1
Statistical result 2	The average value of data 2
Statistical result 3	The average value of data 3
Statistical result 4	The average value of data 4
Statistical result 5	The average value of data 5
Statistical result 6	The average value of data 6
Statistical result 7	The average value of data 7

Key Points for Adjustment (Statistics)

Adjust the setting parameters referring to the following points.

- When the measurement results are false

Parameter to be adjusted	Remedy
Data display	Not all data is included in the calculation. Data outside the judgement range will not be processed. If any necessary data is outside the judgement range, set the judgement range again.
Statistical parameter	The measurement result remains 0.0. If the calculation timing is "Only when the maximum number of data is reached," the measurement result remains 0.0 while the number of measurements is yet to reach the maximum number saved. Change the calculation timing on the statistical parameter tab to "Every time," and the measurement result will be calculated every time.

- When the graph displays are false

Parameter to be adjusted	Remedy
Data display	When a graph showing a flat line appears even when the value is changing, change the graph display range to an appropriate range. If the initial values remain unchanged, the display range is too wide and the graph will show a flat line. Perform measurement at least twice, and then click the default range button on the data display tab.

4-22-7 Measurement Results for Which Output Is Possible (Statistics)

The following values can be output using processing items related to result output. It is also possible to reference measurement values from calculation expressions and other processing units.

Measurement items	Character string	Description
Judge	JG	Judgment results 0: No judgment (unmeasured) 1: Judgment result OK -1: Judgment result NG -10: Error (image format mismatch) -11: Error (unregistered model) -12: Error (insufficient memory) -20: Error (other errors)
No. of measurements	CT	Number of stored times
Statistically processed result N (N = 0 to 7)	DTN(N = 0 to 7)	Average value 0 to 7
Valid statistically processed data N (N = 0 to 7)	OCN(N = 0 to 7)	Number of valid stored data 0 to 7
Max. stored data N (N = 0 to 7)	MXN(N = 0 to 7)	Maximum value of stored data 0 to 7
Min. stored data N (N = 0 to 7)	MNN(N = 0 to 7)	Minimum value of stored data 0 to 7

4-22-8 External Reference Tables (Statistics)

No.	Data name	Data ident	Set/Get	Data range
0	Judge	judge	Get only	0: No judgment (unmeasured), 1: Judgment result OK, -1: Judgment result NG, -10: Error (image format mismatch), -11: Error (unregistered model), -12: Error (insufficient memory), -20: Error (other errors)
5	Measure count	dataCount	Get only	0 to 100
103	Reflect to overall judgement	overallJudge	Set/Get	0: ON, 1: OFF
120	Max. data count	saveDataNum	Set/Get	1 to 100
121	Data No.	dataNo	Set/Get	0 to 7
122	Calculate timing	calcTiming	Set/Get	0 to 1
131+N×10 (N=0 to 7)	Data expression	dataExpression0 to dataExpression7	Set/Get	Exp. character string
132+N×10 (N=0 to 7)	Upper limit of the judgement	upperJudge0 to upperJudge7	Set/Get	-999,999,999.9999 to 999,999,999.9999
133+N×10 (N=0 to 7)	Lower limit of the judgement	lowerJudge0 to lowerJudge7	Set/Get	-999,999,999.9999 to 999,999,999.9999
134+N×10 (N=0 to 7)	Upper limit of the display range	maxVertical0 to maxVertical7	Set/Get	-999,999,999.9999 to 999,999,999.9999
135+N×10 (N=0 to 7)	Lower limit of the display range	minVertical0 to minVertical7	Set/Get	-999,999,999.9999 to 999,999,999.9999
136+N×10 (N=0 to 7)	Amount of change to display range	unitVertical0 to unitVertical7	Set/Get	1.0000 to 1,000,000.0000
137+N×10 (N=0 to 7)	Measurement	resultValue0 to resultValue7	Get only	-999,999,999.9999 to 999,999,999.9999
138+N×10 (N=0 to 7)	Expressions comment	comment0 to comment7	Set/Get	Character string
300+N (N=0 to 7)	Comment view	commentView0 to commentView7	Set/Get	0: OFF, 1: ON
1,000+N×10 (N=0 to 7)	Statistic value	resultData0 to resultData7	Get only	-999,999,999.9999 to 999,999,999.9999
1,001+N×10 (N=0 to 7)	Valid data number	resultDataNum0 to resultDataNum7	Get only	0 to 100
1,002+N×10 (N=0 to 7)	Maximum	saveDataMax0 to saveDataMax7	Get only	-999,999,999.9999 to 999,999,999.9999
1,003+N×10 (N=0 to 7)	Minimum	saveDataMin0 to saveDataMin7	Get only	-999,999,999.9999 to 999,999,999.9999
10,000+N (N=0 to 99)	data 0 saving data	saveDataA00 to saveDataA99	Get only	-999,999,999.9999 to 999,999,999.9999
11,000+N (N=0 to 99)	data 1 saving data	saveDataB00 to saveDataB99	Get only	-999,999,999.9999 to 999,999,999.9999
12,000+N (N=0 to 99)	data 2 saving data	saveDataC00 to saveDataC99	Get only	-999,999,999.9999 to 999,999,999.9999
13,000+N (N=0 to 99)	data 3 saving data	saveDataD00 to saveDataD99	Get only	-999,999,999.9999 to 999,999,999.9999

No.	Data name	Data ident	Set/Get	Data range
14,000+N (N=0 to 99)	data 4 saving data	saveDataE00 to saveDataE99	Get only	-999,999,999.9999 to 999,999,999.9999
15,000+N (N=0 to 99)	data 5 saving data	saveDataF00 to saveDataF99	Get only	-999,999,999.9999 to 999,999,999.9999
16,000+N (N=0 to 99)	data 6 saving data	saveDataG00 to saveDataG99	Get only	-999,999,999.9999 to 999,999,999.9999
17,000+N (N=0 to 99)	data 7 saving data	saveDataH00 to saveDataH99	Get only	-999,999,999.9999 to 999,999,999.9999

4-23 Calibration Data Reference

Calibration data and distortion compensation data held under other processing items can be referenced.

Referenced data will be used to perform coordinate conversion processing and distortion compensation processing on measurement results following this processing unit.

As for distortion compensation processing, you can select not only *Compensate measurement result*, but also *Compensate measurement image*.

Used in the Following case

When positioning the FPD panel

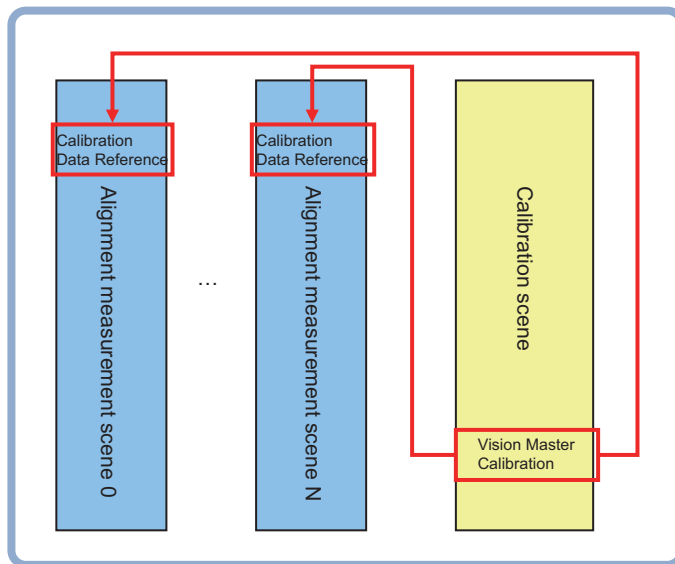

Precautions for Correct Use

In the measurement flow, if the processing unit that generates the calibration data is set after the processing unit that corrects the image, the output coordinates that can be acquired by the processing unit after the processing unit that generates the calibration data are only the coordinates after image correction.

4-23-1 Settings Flow (Calibration Data Reference)

To set Calibration Data Reference, follow the steps below.

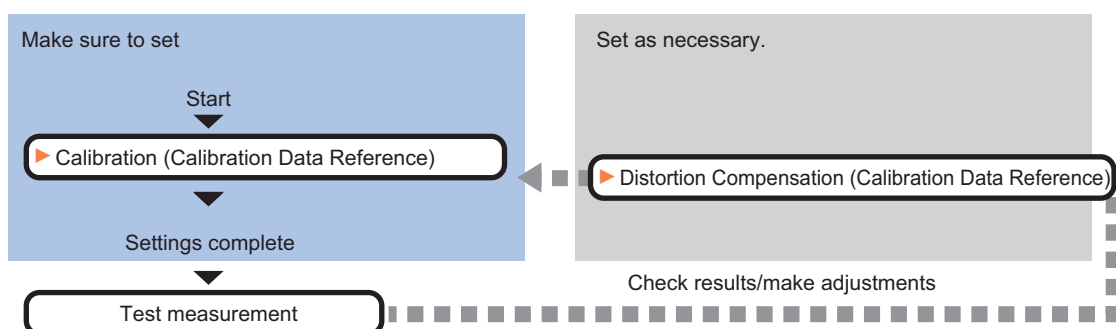

List of Calibration Data Reference items

Item	Description
Calibration	Selects the processing unit holding calibration data. Data can be referenced not only from the current scene but also from other scenes. <i>4-23-2 Calibration (Calibration Data Reference) on page 4-123</i>
Distortion correction	Selects the processing unit holding the distortion compensation data to be referenced. Data can be referenced from not only the current scene but also other scenes. There two selectable compensation methods: image correction and measurement value correction. <i>4-23-3 Distortion Correction (Calibration Data Reference) on page 4-124</i>

4-23-2 Calibration (Calibration Data Reference)

Select the processing unit holding the calibration data to be referenced.

- 1 In the Item tab area, click the **Calibration**
- 2 Select the reference scene No., reference unit No., and reference data No.

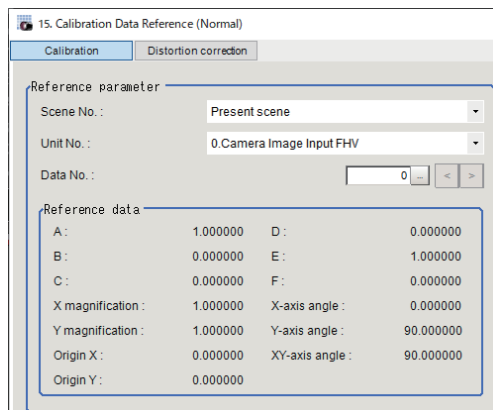

Setting item	Setting value [Factory default]	Description
Scene No.	-	Selects the scene number to be referenced for acquiring calibration data.
Unit No.	-	Selects the unit number to be referenced for acquiring calibration data. Targeted processing units to be referenced are <i>Camera Image Input, Camera Image Input FH, Camera Image Input HDR, Camera Image Input HDR Lite, Vision Master Calibration, PLC Master Calibration, Camera Calibration, and Precise Calibration.</i>
Data No.	-	Selects the position to be referenced of the calibration data that target units hold.

Setting item	Setting value [Factory default]	Description
Reference data	-	displays the calibration data referenced. This display is updated when the reference scene number, reference unit number, or reference calibration data number is changed. When "None" is selected, the initial value is displayed. <ul style="list-style-type: none"> Affine transformation parameter (A to F): Value (up to the sixth decimal place) XY magnification: Value (up to the sixth decimal place) Origin XY: Value (up to the sixth decimal place) X axis angle, Y axis angle, XY angle: Value (up to the sixth decimal place)



Precautions for Correct Use

When the referenced data to be set is different on the referenced parameters in *Calibration* and *Distortion Correction*, specify the data calibrated using distortion-corrected images as reference data to be set with *Calibration* reference parameters.

4-23-3 Distortion Correction (Calibration Data Reference)

Select the processing unit holding the distortion compensation data to be referenced.

- 1 In the Item tab area, click **Distortion correction**.
- 2 Place a check to it and select the reference scene number and reference unit number.

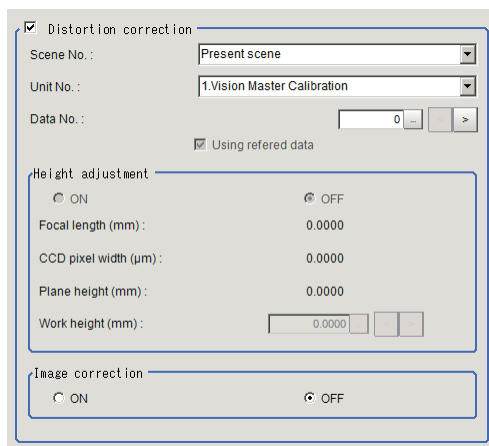

Setting item	Setting value [Factory default]	Description
Distortion correction	-	In the following case, place a check at <i>Distortion correction</i> . <ul style="list-style-type: none"> When <i>Vision Master Calibration</i> was performed with <i>"Trapezoidal distortion and Lens distortion"</i> checked in Distortion Correction setting. When Precise Calibration was performed with the correction setting set to ON in Image Correction tab.
Scene No.	-	Selects the number of the scene to be referenced to obtain distortion compensation data.

Setting item	Setting value [Factory default]	Description
Unit No.	-	Selects the number of the unit to be referenced to obtain distortion compensation data. The reference target units are Precise Calibration and Vision Master Calibration units.
Data No.	0 to 7	Enabled only when Vision Master Calibration is selected as the reference unit.
Using referred data	<ul style="list-style-type: none"> • [Checked] • Unchecked 	-
Height adjustment	<ul style="list-style-type: none"> • ON • [OFF] 	Selects <i>ON</i> when adjusting with the reference data.
Image correction	<ul style="list-style-type: none"> • ON • [OFF] 	Selects <i>ON</i> when correcting images.



Precautions for Correct Use

- When *Image correction* is OFF, distortion correction is processed only for coordinate values.
- Note that no distortion correction is processed for other feature quantities such as an area.

4-23-4 Key Points for Test Measurement and Adjustment (Calibration Data Reference)

The following content is displayed in the *Detail result* area as text.

Displayed item	Description
Judge	Judgment results 0: No judgment (unmeasured) 1: Judgment result OK -1: Judgment result NG -10: Error (image format mismatch) -11: Error (unregistered model) -12: Error (insufficient memory) -20: Error (other errors)
A	Affine transformation parameter A
B	Affine transformation parameter B
C	Affine transformation parameter C
D	Affine transformation parameter D
E	Affine transformation parameter E
F	Affine transformation parameter F
X magnification	X magnification
Y magnification	Y magnification
Origin X	Origin X
Origin Y	Origin Y
X-axis angle	X-axis angle
Y-axis angle	Y-axis angle
XY-axis angle	XY-axis angle

4-23-5 Measurement Results for Which Output Is Possible (Calibration Data Reference)

The following values can be output using processing items related to result output. It is also possible to reference measurement values from calculation expressions and other processing units.

Measurement items	Character string	Description
Judge	JG	Judgment results 0: No judgment (unmeasured) 1: Judgment result OK -1: Judgment result NG -10: Error (image format mismatch) -11: Error (unregistered model) -12: Error (insufficient memory) -20: Error (other errors)

4-23-6 External Reference Tables (Calibration Data Reference)

No.	Data name	Data ident	Set/Get	Data range
0	Judge	judge	Get only	0: No judgment (unmeasured), 1: Judgment result OK, -1: Judgment result NG
5	A	calibParamA	Get only	-
6	B	calibParamB	Get only	-
7	C	calibParamC	Get only	-
8	D	calibParamD	Get only	-
9	E	calibParamE	Get only	-
10	F	calibParamF	Get only	-
11	X magnification	scaleX	Get only	-
12	Y magnification	scaleY	Get only	-
13	Origin X	centerX	Get only	-
14	Origin Y	centerY	Get only	-
15	X-axis angle	angleX	Get only	-
16	Y-axis angle	angleY	Get only	-
17	XY-axis angle	angleXY	Get only	-
18	Lens focus[mm]	physicalFocus	Get only	3 to 200
19	CCD1 pixel size[um]	ccdPixSize	Get only	1 to 15
20	Plate height[mm]	plateHeight	Get only	-100 to 100
21	Depth setting	useDepth	Get only	0: OFF, 1: ON
22	Image correction setting	correctSetting	Get only	0: OFF, 1: ON
23	Work height[mm]	work_height	Get only	-100 to 100
120	Scene No.(Calibration)	sceneNo	Set/Get	-1: Refer to present scene 0 to 9,999: Refer to scene No.
121	Unit No.(Calibration)	unitNo	Set/Get	-1: No reference 0 to 9,999: Refer to unit No.
122	Data No.(Calibration)	dataNo	Set/Get	0 to 7: Refer to data No.

No.	Data name	Data ident	Set/Get	Data range
123	Scene No.(Distortion correction)	sceneNoCorrect	Set/Get	-1:Refer to present scene 0 to 9,999: Refer to scene No.
124	Unit No.(Distortion correction)	unitNoCorrect	Set/Get	-1: No reference 0 to 9,999: Refer to unit No.
125	Distortion correction setting	distortionCorrect	Set/Get	0: OFF, 1: ON
126	Depth setting without reference	useDepthRenew	Set/Get	0: OFF, 1: ON
127	Using refered data	referenceSetting	Set/Get	0: OFF, 1: ON
128	Image correction setting without reference	correctSettingRenew	Set/Get	0: OFF, 1: ON
129	Work height without reference	work_heightRenew	Set/Get	-100 to 100
130	Data No.(Distortion correction)	dataNoCorrect	Set/Get	0 to 7: Refer to data No.

4-24 Position Data Calculation

Midpoint coordinates and angle heavily-used in alignment applications are easily calculated.

- The angle of a straight line connected two points and the midpoint coordinates for two points
- The average angle of opposing two sides and the midpoint coordinates for four points

The calculated position and angle data can be used in Calc Axis Move.

Used in the Following case

When positioning the FPD panel

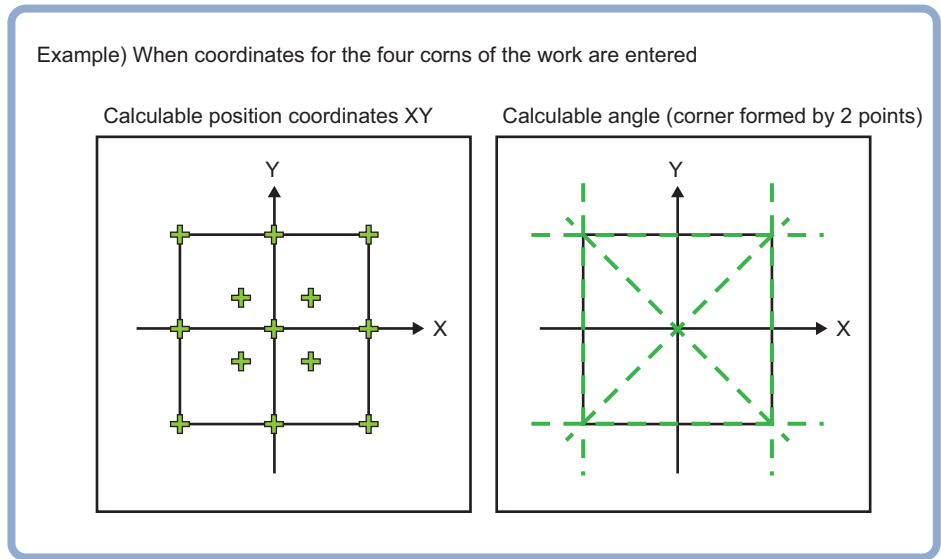

4-24-1 Settings Flow (Position Data Calculation)

To set Position Data Calculation, follow the steps below.

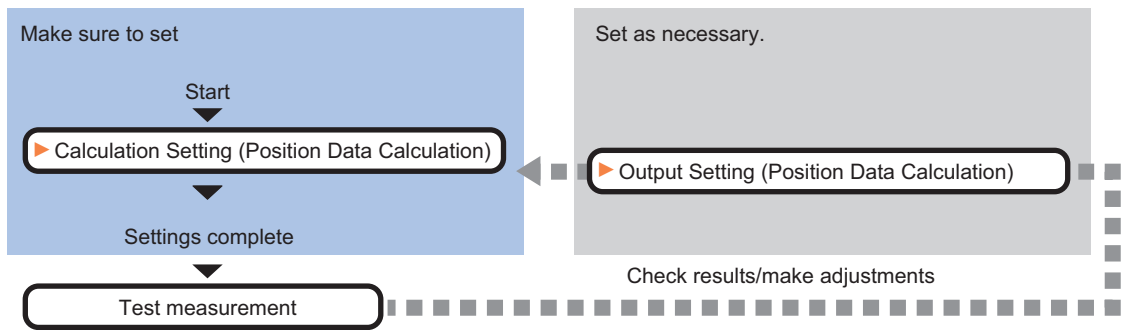

List of Position Data Calculation Items

Item	Description
Calculation setting	Sets the data to be processed using an expression. Up to 4 data can be set. The position data to be output is calculated using the average position data of the points selected in <i>Calculate position target</i> . The angle data to be output is calculated using the method selected in <i>Calculate angle target</i> 4-24-2 <i>Calculation Setting (Position Data Calculation)</i> on page 4-129
Output parameter	This item is changed as necessary. Selects whether or not to reflect the judgment result to the overall judgment of the scene. 4-24-3 <i>Output parameter (Position Data Calculation)</i> on page 4-133

4-24-2 Calculation Setting (Position Data Calculation)

Calculates position data and angle data used in the axis movement amount calculation based on the measurement results of multiple processing items.

- 1 In the Item tab area, click **Calculation setting**.
- 2 In the *Point 0* to *Point 3* area, click  at the right end of each text box to set the position data for *Point 0* to *Point 3* used in the position data calculation.
The *Setting Expression* window is displayed to set the position X, Y, and angle.
For details, refer to 4-3-3 *Layout of Setting Expression Window (Calculation)* on page 4-12.

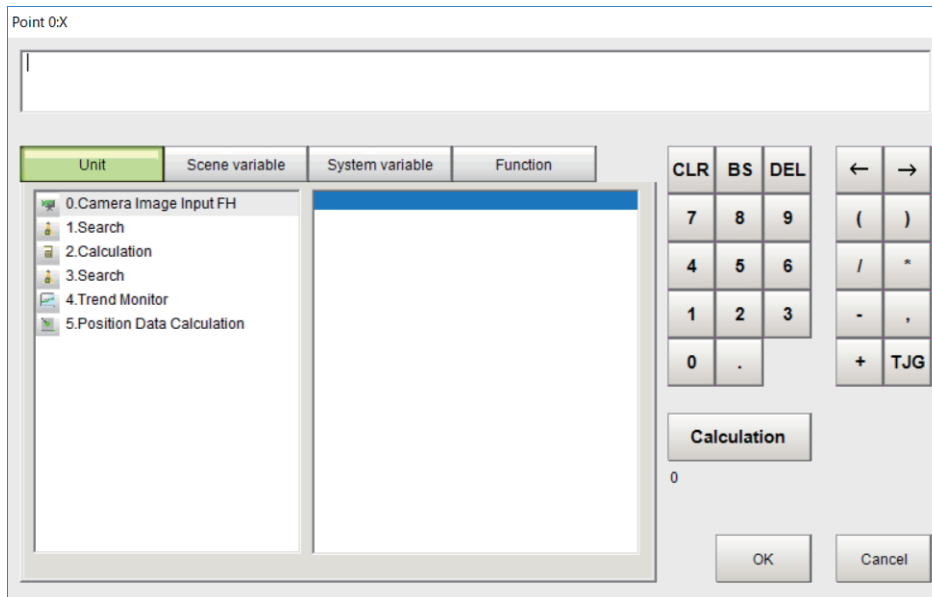

- 3** In the *Calculate position target* area, select points to calculate the position. An arithmetic average for coordinate values is calculated using the coordinates of the selected points.
- 4** In the *Calculate angle target* area, selects the point and method to calculate the angle. When calculating an average angle between two sides, place a check at *Calculate avg. 2 angles* and select the point and method in *Angle 1* to be used. The angle data calculated by the selected method is output.

Setting item	Setting value [Factory default]	Description
Angle 0 Angle 1	<ul style="list-style-type: none"> • Point 0 to 3 • Line (Point0-Point1) • Line (Point0-Point2) • Line (Point0-Point3) • Line (Point1-Point0) • Line (Point1-Point2) • Line (Point1-Point3) • Line (Point2-Point0) • Line (Point2-Point1) • Line (Point2-Point3) • Line (Point3-Point0) • Line (Point3-Point1) • Line (Point3-Point2) 	<p>Selects the method to calculate the angle.</p> <p>Line (Point0-Point1) indicates an angle between X-axis and the line created by connecting Point 0 and Point 1.</p> <p>Angle 1 is enabled when <i>Calculate avg. of 2 angles</i> is checked.</p>
Calculate avg. of 2 angles	<ul style="list-style-type: none"> • Checked • [Unchecked] 	<p>Place a check here when calculating an average of <i>Angle 0</i> and <i>Angle 1</i> in Calculate angle target. When it is unchecked, <i>Angle 1</i> will be disabled.</p>



Additional Information

- As for the calculation of the angle formed by points, **Line (Point0-Point1)** and **Line (Point1-Point0)** produces different angles. Use the suitable one.

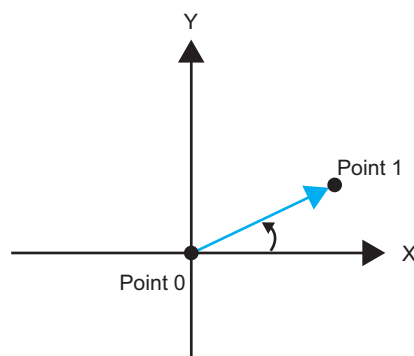

Fig. 1 angle of a side line formed by Point 0 – 1

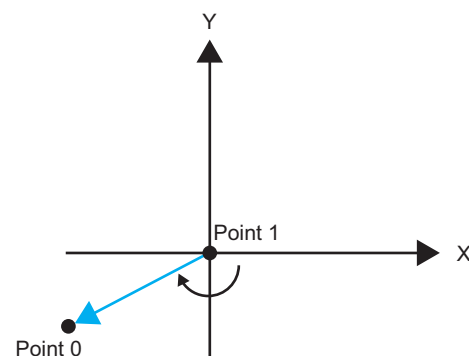

Fig. 2 angle of a side line formed by Point 1 – 0

- As for data necessary for the calculation, the points X and Y for the points checked for position data calculation must not be empty. The angle data is as shown in the table below.

Data necessary for calculating angle data (o: input required)

Angle calculation method selection	Point 0		Point 1		Point 2		Point 3	
	Position X, Y	Angle	Position X, Y	Angle	Position X, Y	Angle	Position X, Y	Angle
Point 0		o						
Point 1				o				
Point 2						o		
Point 3								o
Side line formed by Points 0-1	o		o					
Side line formed by Points 0-2	o				o			
Side line formed by Points 0-3	o						o	
Side line formed by Points 1-0	o		o					
Side line formed by Points 1-2			o		o			
Side line formed by Points 1-3			o				o	
Side line formed by Points 2-0	o				o			
Side line formed by Points 2-1			o		o			
Side line formed by Points 2-3					o		o	
Side line formed by Points 3-0	o						o	
Side line formed by Points 3-1			o				o	
Side line formed by Points 3-2					o		o	

- 5 Specify the angle range to be output.
- 6 When the settings are changed, click **Measure** and check the calculation results
- 7 Set the judgment conditions.

Setting item	Setting value	Description
Calculate position X	-99,999.9999 to 99,999.9999	Sets the calculation position range for X-axis direction to be judged as OK.
Calculate position Y	-99,999.9999 to 99,999.9999	Sets the calculation position range for Y-axis direction to be judged as OK.
Calculate position angle	-180.0000 to 360.0000	Sets the calculation angle range for to be judged as OK.

4-24-3 Output parameter (Position Data Calculation)

Select whether or not to reflect the judgment results of this processing unit to the overall judgment of the scene.

- 1 In the Item tab area, click **Output parameter**.
- 2 Select whether or not to reflect it to the overall judgment in *Reflect to overall judgement* area.

Setting item	Setting value [Factory default]	Description
Reflect to overall judgment	<ul style="list-style-type: none"> • [ON] • OFF 	Enables choosing whether or not the judgement results of this processing unit is reflected in the scene overall judgment.

4-24-4 Key Points for Test Measurement and Adjustment (Position Data Calculation)

The following content is displayed in the *Detail result* area as text.

Displayed item	Description
Judge	Judgment results 0: No judgment (unmeasured) 1: Judgment result OK -1: Judgment result NG -10: Error (image format mismatch) -11: Error (unregistered model) -12: Error (insufficient memory) -20: Error (other errors)
Calculation position X	Calculation position X
Calculation position Y	Calculation position Y
Calculation angle	Calculation angle

4-24-5 Measurement Results for Which Output Is Possible (Position Data Calculation)

The following values can be output using processing items related to result output. It is also possible to reference measurement values from calculation expressions and other processing units.

Measurement items	Character string	Description
Judge	JG	Judgment results 0: No judgment (unmeasured) 1: Judgment result OK -1: Judgment result NG -10: Error (image format mismatch) -11: Error (unregistered model) -12: Error (insufficient memory) -20: Error (other errors)
Calculation position X	X	Calculation position X
Calculation position Y	Y	Calculation position Y

Measurement items	Character string	Description
Calculation angle	TH	Calculation angle
Calculation angle (Point 0)	TH0	Calculation angle for Point 0
Calculation angle (Point 1)	TH1	Calculation angle for Point 1
Calculation angle (Point 2)	TH2	Calculation angle for Point 2
Calculation angle (Point 3)	TH3	Calculation angle for Point 3
Calculation angle (Point 0-1)	TH01	Angle created by connecting Point 0-1
Calculation angle (Point 0-2)	TH02	Angle created by connecting Point 0-2
Calculation angle (Point 0-3)	TH03	Angle created by connecting Point 0-3
Calculation angle (Point 1-0)	TH10	Angle created by connecting Point 1-0
Calculation angle (Point 1-2)	TH12	Angle created by connecting Point 1-2
Calculation angle (Point 1-3)	TH13	Angle created by connecting Point 1-3
Calculation angle (Point 2-0)	TH20	Angle created by connecting Point 2-0
Calculation angle (Point 2-1)	TH21	Angle created by connecting Point 2-1
Calculation angle (Point 2-3)	TH23	Angle created by connecting Point 2-3
Calculation angle (Point 3-0)	TH30	Angle created by connecting Point 3-0
Calculation angle (Point 3-1)	TH31	Angle created by connecting Point 3-1
Calculation angle (Point 3-2)	TH32	Angle created by connecting Point 3-2

4-24-6 External Reference Tables (Position Data Calculation)

No.	Data name	Data ident	Set/Get	Data range
0	Judge	judge	Get only	0: No judgment (unmeasured), 1: Judgment result OK, -1: Judgment result NG
5	Calculate position X	positionX	Get only	-99,999.9999 to 99,999.9999
6	Calculate position Y	positionY	Get only	-99,999.9999 to 99,999.9999
7	Calculate angle	angle	Get only	-180 to 360
8	Calculate angle (point 0)	angle0	Get only	-180 to 360
9	Calculate angle (point 1)	angle1	Get only	-180 to 360
10	Calculate angle (point 2)	angle2	Get only	-180 to 360
11	Calculate angle (point 3)	angle3	Get only	-180 to 360
12	Calculate angle (point0 - point1)	angle4	Get only	-180 to 360
13	Calculate angle (point0 - point2)	angle5	Get only	-180 to 360
14	Calculate angle (point0 - point3)	angle6	Get only	-180 to 360
15	Calculate angle (point1 - point0)	angle7	Get only	-180 to 360
16	Calculate angle (point1 - point2)	angle8	Get only	-180 to 360
17	Calculate angle (point1 - point3)	angle9	Get only	-180 to 360

No.	Data name	Data ident	Set/Get	Data range
18	Calculate angle (point2 - point0)	angle10	Get only	-180 to 360
19	Calculate angle (point2 - point1)	angle11	Get only	-180 to 360
20	Calculate angle (point2 - point3)	angle12	Get only	-180 to 360
21	Calculate angle (point3 - point0)	angle13	Get only	-180 to 360
22	Calculate angle (point3 - point1)	angle14	Get only	-180 to 360
23	Calculate angle (point3 - point2)	angle15	Get only	-180 to 360
103	Reflect to overall judgment	overallJudge	Set/Get	0: ON, 1: OFF
120	Position calculation method: point 0	positionCalcType1	Set/Get	0: NOT checked, 1: Checked
121	Position calculation method: point 1	positionCalcType2	Set/Get	0: NOT checked, 1: Checked
122	Position calculation method: point 2	positionCalcType3	Set/Get	0: NOT checked, 1: Checked
123	Position calculation method: point 3	positionCalcType4	Set/Get	0: NOT checked, 1: Checked
124	Calculate angle target of angle 0	angleCalcType	Set/Get	0: Point 0, 1: Point 1, 2: Point 2, 3: Point 3, 4: Line (point0 - point1), 5: Line (point0 - point2), 6: Line (point0 - point3), 7: Line (point1 - point0), 8: Line (point1 - point2), 9: Line (point1 - point3), 10: Line (point2 - point0), 11: Line (point2 - point1), 12: Line (point2 - point3), 13: Line (point3 - point0), 14: Line (point3 - point1), 15: Line (point3 - point2)
125	Upper limit of calculate position X	upperX	Set/Get	-99,999.9999 to 99,999.9999
126	Lower limit of calculate position X	lowerX	Set/Get	-99,999.9999 to 99,999.9999
127	Upper limit of calculate position Y	upperY	Set/Get	-99,999.9999 to 99,999.9999
128	Lower limit of calculate position Y	lowerY	Set/Get	-99,999.9999 to 99,999.9999
129	Upper limit of calculate angle	upperAngle	Set/Get	-180 to 360
130	Lower limit of calculate angle	lowerAngle	Set/Get	-180 to 360
131	Point 0:X	expPositionX1	Set/Get	Exp. character string
132	Point 0:Y	expPositionY1	Set/Get	Exp. character string
133	Point 0:Angle	expAngle1	Set/Get	Exp. character string

No.	Data name	Data ident	Set/Get	Data range
141	Point 1:X	expPositionX2	Set/Get	Exp. character string
142	Point 1:Y	expPositionY2	Set/Get	Exp. character string
143	Point 1:Angle	expAngle2	Set/Get	Exp. character string
151	Point 2:X	expPositionX3	Set/Get	Exp. character string
152	Point 2:Y	expPositionY3	Set/Get	Exp. character string
153	Point 2:Angle	expAngle3	Set/Get	Exp. character string
161	Point 3:X	expPositionX4	Set/Get	Exp. character string
162	Point 3:Y	expPositionY4	Set/Get	Exp. character string
163	Point 3:Angle	expAngle4	Set/Get	Exp. character string
164	Calculate angle target of angle 1	angleCalcType1	Set/Get	0: Point 0, 1: Point 1, 2: Point 2, 3: Point 3, 4: Line (point0 - point1), 5: Line (point0 - point2), 6: Line (point0 - point3), 7: Line (point1 - point0), 8: Line (point1 - point2), 9: Line (point1 - point3), 10: Line (point2 - point0), 11: Line (point2 - point1), 12: Line (point2 - point3), 13: Line (point3 - point0), 14: Line (point3 - point1), 15: Line (point3 - point2)
165	Calculate average of 2 angles or not	isTwoAngleAverage	Set/Get	0: Calculate angle of angle 0 1: Calculate average of 2 angles
166	Angle range	angleRange	Set/Get	0: $-180^\circ < \theta \leq 180^\circ$ 1: $0^\circ \leq \theta < 360^\circ$

4-25 Robot Data

Sets and stores data related to robots.

When the following processing items are used in an environment with robots, this processing item is required.

- Vision Master Calibration
- PLC Master Calibration
- Calibration Data Reference
- Transfer Position Data
- Calc Axis Move
- Calc Axis Move by Multipoint

Used in the Following Case

When setting parameters for robots to be used and the rotation polarity

Ex. ; palletizing of electronic parts

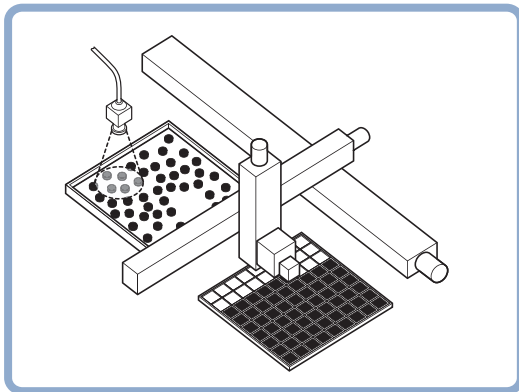

4-25-1 Data Setting (Robot Data)

Here, set data about robots.

Set the data based on the robot specifications.

- 1 In the Item tab area, click **Data setting**.
- 2 In the *Robot setting* area, select the type of robot.
Selecting *Four axis (XYZR)* enables you to select *Rotation polarity*.

Robot setting

Robot type : Three axis (XYZ)

Rotation polarity : Positive Negative

Setting item	Setting value [Factory default]	Description
Robot type	<ul style="list-style-type: none"> • [Three axis (XYZ)] • Four axis (XYZR) • Six axis (XYZWPR) 	Selects the type of robot to be used.
Rotation polarity	<ul style="list-style-type: none"> • [Positive] • Negative 	<p>Selects the rotation direction defined as the equipment based on that of the robot coordinate system.</p> <ul style="list-style-type: none"> • Positive: From X-axis to Y-axis • Negative: From Y-axis to X-axis <div style="text-align: center;"> <p>Y</p> <p>X</p> <p>Stage coordinate system</p> <p>When positive rotation direction of the device is A: positive polarity B: negative polarity</p> </div>

● **Three axis (XYZ) Robot**

1 When selecting *Three axis (XYZ)*, the *Three axis (XYZ) setting* area is displayed.

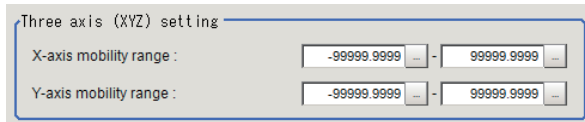

2 In the *Three axis (XYZ) setting* area, click in the *X-axis limit* to set the upper and lower limits.

3 Likewise, click in the *Y-axis limit* to set the upper and lower limits.

Setting item	Setting value [Factory default]	Description
X-axis limit	-99,999.9999 to 99,999.9999 [-99,999.9999] to [99,999.9999]	Sets the upper and lower limits for the X-axis movement range. The unit used is a coordinate system set in calibration.
Y-axis limit	-99,999.9999 to 99,999.9999 [-99,999.9999] to [99,999.9999]	Sets the upper and lower limits for the Y-axis movement range. The unit used is a coordinate system set in calibration.

● **Four axis (XYZR) Robot**

- 1** When selecting *Four axis (XYZR)*, the *Four axis (XYZR) setting* area is displayed.

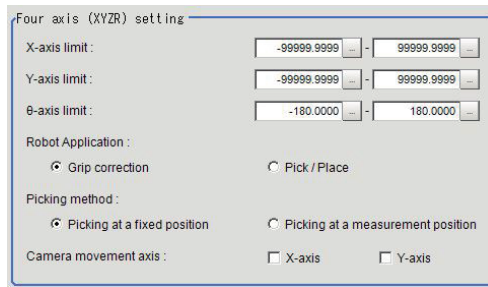

Four axis (XYZR) setting

X-axis limit: [-99999.9999] - [99999.9999]

Y-axis limit: [-99999.9999] - [99999.9999]

θ-axis limit: [-180.0000] - [180.0000]

Robot Application :



Grip correction Pick / Place

Picking method :

Picking at a fixed position Picking at a measurement position

Camera movement axis :

X-axis Y-axis

- 2** In the *Four axis (XYZR) setting* area, click  in the *X-axis limit* to set the upper and lower limits.
- 3** Likewise, click  in the *Y-axis limit* to set the upper and lower limits.
- 4** Likewise, click  in the *y-axis limit* to set the upper and lower limits.
- 5** Select the application in the *Robot application*
- 6** Select the control method of robot in the *Picking method*.
- 7** When the camera is used by moving, select the axis to which the camera is attached in the *Camera movement axis*.

Setting item	Setting value [Factory default]	Description
X-axis limit	-99,999.9999 to 99,999.9999 [-99,999.9999] to [99,999.9999]	Sets the upper and lower limits for the X-axis movement range. The unit used is a coordinate system set in calibration.
Y-axis limit	-99,999.9999 to 99,999.9999 [-99,999.9999] to [99,999.9999]	Sets the upper and lower limits for the Y-axis movement range. The unit used is a coordinate system set in calibration.
θ-axis limit	-180.0000 to 180.0000 [-180.0000] to [180.0000]	Sets the upper and lower limits for θ-axis angle movement range. Unit: degree
Robot application	<ul style="list-style-type: none"> [Grip correction Pick/Place 	Set the robot application. <ul style="list-style-type: none"> Grip correction: Calculate an amount of deviation from the reference position by measuring the image of a workpiece gripped. Pick/Place: Moves the robot hand to pick and place positions measured by the image.

Setting item	Setting value [Factory default]	Description	
Picking method	<ul style="list-style-type: none"> • [Picking at a fixed position] • Picking at a measurement position 	<p>Selects the control method of robot.</p> <p>The robot control settings vary depending on at which stage from the stage of gripping a workpiece to the one of moving it is used for positioning.</p> <ul style="list-style-type: none"> • Picking at a fixed position: Select this when the robot hand moves to the same position every time to pick up a workpiece and place it on a specific position by using measurement results from the Sensor Controller. This is some kind of palletizing application. Specifically speaking, in this setting, the same calculation as the XYθ stage is performed. • Picking at a measurement position: Select this when the robot hand moves to a position to pick up a workpiece by using measurement results from the Sensor Controller every time and place it on a specific position after grasping it. This is some kind of depalletizing application. Specifically speaking, in this setting, the same calculation as the θXY stage is performed. 	
Camera movement axis	X-axis	<ul style="list-style-type: none"> • Checked • [Unchecked] 	Enables this setting when the camera moves instead of the robot axis.
	Y-axis	<ul style="list-style-type: none"> • Checked • [Unchecked] 	When this is disabled, a movement amount and so on is calculated on the premise that the stage moves.





Precautions for Correct Use

The conditions are not supported when the *Robot Application* is **Pick / Place** and the *Camera mount method* is **On hand**. It becomes setting NG at the time of calibration.

● Six axis (XYZWPR) Robot

- 1 When *Six axis (XYZWPR)* is selected, the *Six axis (XYZWPR) setting* area is displayed.

- 2 In the *Six axis (XYZWPR) setting* area, click  in the *X-axis limit* to set the upper and lower limits.
- 3 Likewise, click  in the *Y-axis limit* to set the upper and lower limits.
- 4 Select the camera mount method in the *Camera mount method*.
- 5 Select the robot posture in the *Representation of pose*.

Setting item	Setting value [Factory default]	Description
X-axis limit	-99,999.9999 to 99,999.9999 [-99,999.9999] to [99,999.9999]	Sets the upper and lower limits for the X-axis movement range. The unit used is a coordinate system set in calibration.
Y-axis limit	-99,999.9999 to 99,999.9999 [-99,999.9999] to [99,999.9999]	Sets the upper and lower limits for the Y-axis movement range. The unit used is a coordinate system set in calibration.
Camera mount method	<ul style="list-style-type: none"> [Fixed] On hand 	Selects the camera mount method. When <i>Grip correction</i> is selected in <i>Robot Application</i> , <i>Fixed</i> is only its option.
Representation of pose	<ul style="list-style-type: none"> [ZYX Euler angles] ZYZ Euler angles 	Sets the robot posture. Which option to select depends on robot manufacturers.

4-25-2 Measurement Results for Which Output Is Possible (Robot Data)

The following values can be output using processing items related to result output. It is also possible to reference measurement values from calculation expressions and other processing units.

Measurement items	Character string	Description
Judge	JG	Judgment results 0: No judgment (unmeasured) 1: Judgment result OK -1: Judgment result NG -10: Error (image format mismatch) -11: Error (unregistered model) -12: Error (insufficient memory) -20: Error (other errors)

4-25-3 External Reference Tables (Robot Data)

No.	Data name	Data ident	Set/Get	Data range
0	Judge	judge	Get only	0: No judgment (unmeasured), 1: Judgment result OK, -1: Judgment result NG, -10: Error (image format mismatch), -11: Error (unregistered model), -12: Error (insufficient memory), -20: Error (other errors)
120	Robot type	machineType	Set/Get	0: Three axis (XYZ) robot 1: Four axis (XYZR) robot 2: Six axis (XYZWPR) robot
121	Rotation polarity	rotationPolarValue	Set/Get	-1: Negative, 1: Positive
122	Picking method	robotControlType	Set/Get	0: Picking at a fixed position 1: Picking at a measurement position

No.	Data name	Data ident	Set/Get	Data range
123	Camera movement axis X-axis	cameraMoveAxisX	Set/Get	0: Camera moving axis X is not used., 1: Camera moving axis X is used.
124	Camera movement axis Y-axis	cameraMoveAxisY	Set/Get	0: Camera moving axis Y is not used., 1: Camera moving axis Y is used.
125	Camera mount method	cameraMount	Set/Get	0: Fixed, 1: On hand
126	Robot Application	robotApplication-Mode	Set/Get	0: Grip correction 1: Pick / Place
130	Lower limit of X-axis movement	lowerMoveX	Set/Get	-99,999.9999 to 99,999.9999
131	Upper limit of X-axis movement	upperMoveX	Set/Get	-99,999.9999 to 99,999.9999
132	Lower limit of Y-axis movement	lowerMoveY	Set/Get	-99,999.9999 to 99,999.9999
133	Upper limit of Y-axis movement	upperMoveY	Set/Get	-99,999.9999 to 99,999.9999
134	Lower limit of θ -axis movement	lowerMoveTheta	Set/Get	-180 to 180
135	Upper limit of θ -axis movement	upperMoveTheta	Set/Get	-180 to 180
150	Six axis (XYZWPR) representation of pose	poseRotationType	Set/Get	0: ZYX Euler angles 1: ZYZ Euler angles

4-26 Vision Master Calibration

This processing item is specialized for calibration between the camera coordinate system and control equipment coordinate system.

Moreover, this item automatically calculates all amount of axis movement of the control equipment required for calibration.

Therefore, the calibration can be done simply and precisely than before.

Used in the Following Case

When positioning the FPD panel:

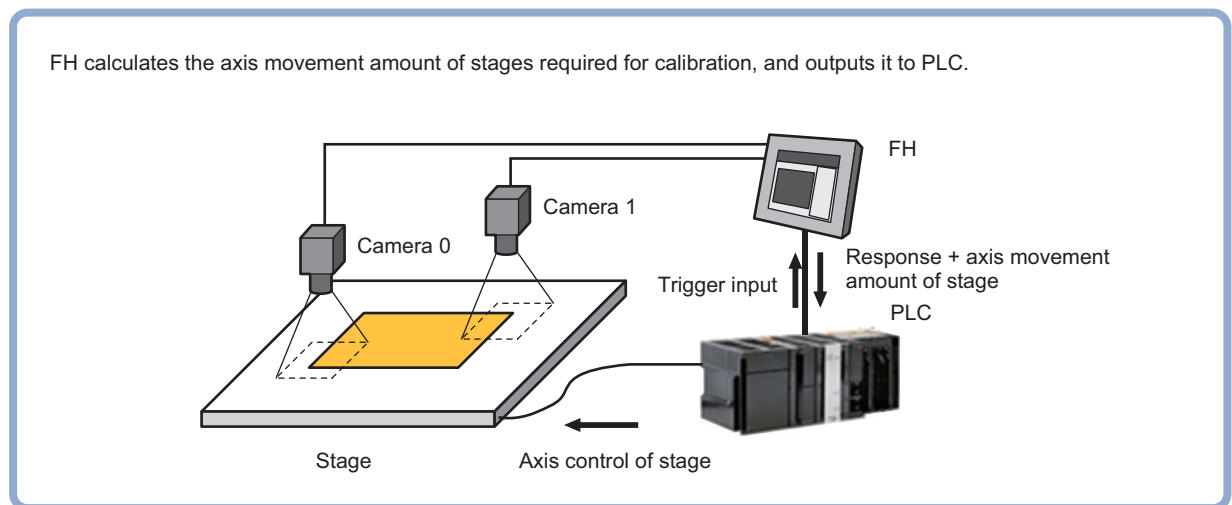

Precautions for Correct Use

- The calibration data created with this processing item is referenced with *Calibration Data Reference*. Unlike other calibration-related processing items, note that this processing item itself cannot use the calibration data.
- This item refers to processing items such as **Stage Data** or **Robot Data** which hold external equipment information required for calculating the axis movement amount. When the information is changed, the contents in this item is also changed. In that case, re-check the settings for this item.
- In the measurement flow, if the processing unit that generates the calibration data is set after the processing unit that corrects the image, the output coordinates that can be acquired by the processing unit after the processing unit that generates the calibration data are only the coordinates after image correction.

4-26-1 Settings Flow (Vision Master Calibration)

To set Vision Master Calibration, follow the steps below.

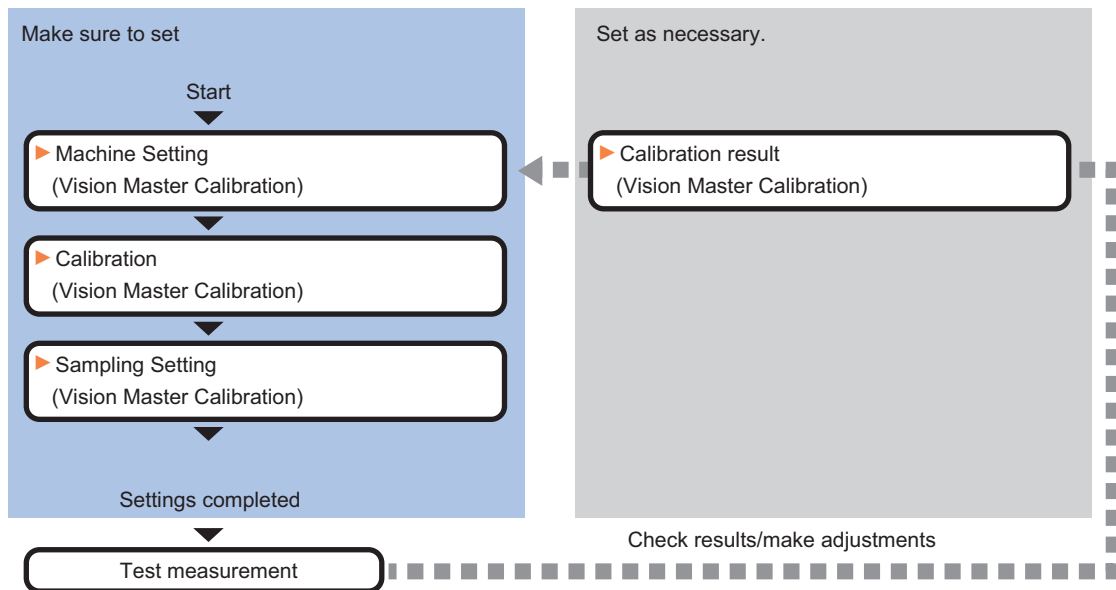

List of Vision Master Calibration Items

Item	Description
Machine setting	Selects a processing item such as <i>Stage Data</i> or <i>Robot Data</i> under which external device information needed for calculation travel distance of the actuator is held. <i>4-26-2 Machine Setting (Vision Master Calibration)</i> on page 4-144
Calibration	Sets data related to calibration. Sets the number of calibration data to be created and the measurement processing items used for sampling. Here also sets an output method for the calculated axis movement amount. <i>4-26-3 Calibration (Vision Master Calibration)</i> on page 4-145
Sampling setting	Sets data related to sampling. Also perform sampling settings for the initial calibration and this calibration respectively. <i>4-26-4 Sampling Setting (Vision Master Calibration)</i> on page 4-149
Calibration result	Check the calibration data created. To fine-tune the calibration data directly, use <i>Edit</i> function. <i>4-26-5 Calibration Result (Vision Master Calibration)</i> on page 4-162

4-26-2 Machine Setting (Vision Master Calibration)

Select a processing item such as *Stage Data* or *Robot Data* under which external device information needed for calculation of axis movement amount of the actuator is held.



Precautions for Correct Use

This item refers to *Stage Data* or *Robot Data*. Be sure to register *Stage Data* or *Robot Data* with a given scene.

- 1 In the Item tab area, click **Machine setting**.

- 2 Select a processing unit holding the external device information.
Information of the selected processing unit is displayed in the *Reference data* area.
Displayed contents vary depending on the type of stage or robot selected in *Stage Data* or *Robot Data* processing items.

Machine setting data

Scene No. : Present scene

Unit No. : 10.Stage data

Reference data

Stage type : XY stage

Setting item	Setting value [Factory default]	Description
Reference scene No.	[Present scene] Scene 0 to 127	Selects the scene number including a processing item such as Stage Data or <i>Robot Data</i> under which the external device information needed for calculating the axis movement amount of the actuator is held.
Reference No.	-	From among the referenced scene numbers, selects a processing item such as Stage Data or <i>Robot Data</i> under which the external device information needed for calculating the axis movement amount of the actuator is held.
Reference data	-	Displays the settings of Stage Data or <i>Robot Data</i> processing item.



Additional Information

When the number of scenes is increased with the scene group conversion tool, the upper limit value that is selectable in *Reference scene No.* is changed.

4-26-3 Calibration (Vision Master Calibration)

Set data related to calibration. Set the number of calibration data to be created and the measurement processing items used for sampling. Here also set an output method for the calculated axis movement amount. Displayed contents vary depending on the type of stage or robot selected in *Stage Data* or *Robot Data* processing items.

- 1 In the Item tab area, click **Calibration settings**.
- 2 Place a check at the calibration data items to set.
The calibration data checked in the No. will be created.

No.	Input image unit	Position X	Position Y	Judge expression	Judge lower limit	Judge upper limit
<input checked="" type="checkbox"/> 0.	<Nothing>			TJG	1.0000	1.0000
<input type="checkbox"/> 1.	<Nothing>			TJG	1.0000	1.0000
<input type="checkbox"/> 2.	<Nothing>			TJG	1.0000	1.0000
<input type="checkbox"/> 3.	<Nothing>			TJG	1.0000	1.0000
<input type="checkbox"/> 4.	<Nothing>			TJG	1.0000	1.0000
<input type="checkbox"/> 5.	<Nothing>			TJG	1.0000	1.0000
<input type="checkbox"/> 6.	<Nothing>			TJG	1.0000	1.0000
<input type="checkbox"/> 7.	<Nothing>			TJG	1.0000	1.0000

No. Input image unit: Position X: Position Y: Judge expression: Judge condition:

0. <Nothing> [] [] TJG [1.0000] [1.0000]

3 Select the row of the calibration data to set.

No.	Input image unit	Position X	Position Y	Judge expression	Judge lower limit	Judge upper limit
<input checked="" type="checkbox"/> 0.	<Nothing>			TJG	1.0000	1.0000
<input type="checkbox"/> 1.	<Nothing>			TJG	1.0000	1.0000
<input type="checkbox"/> 2.	<Nothing>			TJG	1.0000	1.0000
<input type="checkbox"/> 3.	<Nothing>			TJG	1.0000	1.0000
<input type="checkbox"/> 4.	<Nothing>			TJG	1.0000	1.0000
<input type="checkbox"/> 5.	<Nothing>			TJG	1.0000	1.0000
<input type="checkbox"/> 6.	<Nothing>			TJG	1.0000	1.0000
<input type="checkbox"/> 7.	<Nothing>			TJG	1.0000	1.0000

No. Input image unit: Position X: Position Y: Judge expression: Judge condition:

0. <Nothing> [] [] TJG [1.0000] [1.0000]

4 Set each item in the *Calibration target* area.

Setting item	Setting value [Factory default]	Description
Input image unit	[<Nothing>]	Selects an image input unit used for sampling measurement.
Position X	-	Sets the expression to acquire camera coordinate X used for sampling.
Position Y	-	Sets the expression to acquire camera coordinate Y used for sampling.
Judge expression	[TJG]	Sets the expression to determine whether or not sampling was successful. If calibration fails with the initial value TJG, set the unit judgment JG for the processing unit referencing X and Y positions.
Judge condition	-999,999,999.9999 to 999,999,999.9999 [1.0000] to [1.0000]	Sets the upper and lower limits to determine whether or not sampling was successful. When TJG or JG is set to the judgment expression, use the initial value as is.

5 Select the output method for an amount of movement in the *Movement output method* area.

movement output method

Absolute position Relative position

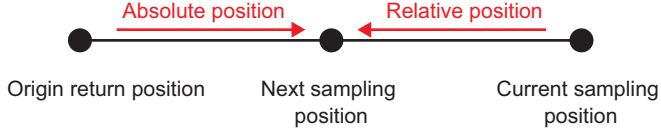
Setting item	Setting value [Factory default]	Description
Movement output method	<ul style="list-style-type: none"> • [Absolute position] • Relative position 	<p>Selects the calculation method for the axis movement amount output to the external device next time. The movement amount output method affects the <i>Next movement amount</i> to be obtained with calculation. This setting needs to be modified according to the specifications of your control equipment used.</p> <ul style="list-style-type: none"> • Absolute position: Always outputs the axis movement amount from the original return position (0 in the axis movement amount) to the next sampling position. • Relative position: Outputs the axis movement amount from the current sampling position to the next sampling position. 

6 Select whether or not to output distortion compensation parameters in the *Distortion type* area.

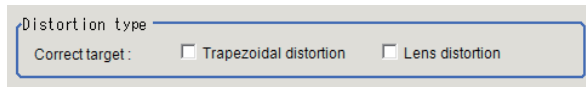

Setting item	Setting value [Factory default]	Description
Trapezoidal distortion	<ul style="list-style-type: none"> • Checked • [Unchecked] 	Selects whether or not to output trapezoidal compensation parameters set for each data.
Lens distortion	<ul style="list-style-type: none"> • Checked • [Unchecked] 	Selects whether or not to output lens distortion compensation parameters set for each data.



Additional Information

Distortion compensation function is not applied for X, Y, Xθ, Yθ, θX, and θY Stages. Therefore, measurement accuracy may decrease if the optic axis is not straight to the surface on which a workpiece is placed. Set the camera optic axis perpendicular to the surface on which a workpiece is located, including move axis.



Precautions for Correct Use

Limit on the number of calibration data when distortion compensation is turned on
 For the FH/FHV series, the number of calibration data is limited by the free memory amount. If the free memory amount became insufficient, it may cause errors in operation mode switching or in adding processing units into the measurement flow. Make sure to create scenes while checking the free memory amount.

- Distortion compensation function
 Since the compensation algorithm of this processing item is as same as that of the *Precise Calibration* processing item, sampling points are going to be biased toward the center of the

screen when the effective range of the field of view is extremely narrowed. That causes an image not to be compensated correctly.

Perform calibration again after widening the effective range of the field of view to spread the sampling points to the entire screen.

If the effective range of the field of view is extremely narrowed, a circular virtual image shown below may appear.

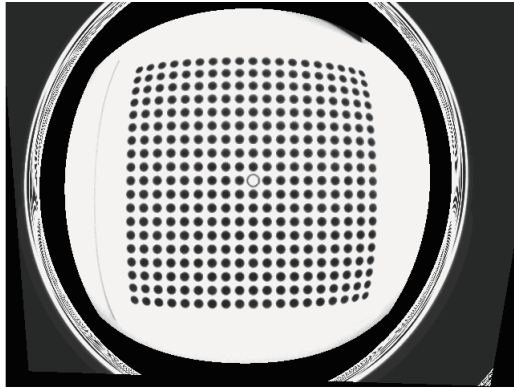

7 Select *Enable* or *Disable* in *Homing operation selection* area.

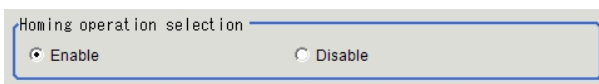

Setting item	Setting value [Factory default]	Description
Homing operation selection	<ul style="list-style-type: none"> [Enable] disable 	Selects <i>Enable</i> or <i>Disable</i> for the <i>Homing operation output flag</i> during sampling. <ul style="list-style-type: none"> Enable: Outputs the <i>Homing operation output flag</i>. Disabled: Not outputs the <i>Homing operation output flag</i> and always turns it off.

- Homing operation selection
 Selecting *Enable* for the *Homing operation selection* turns the *Homing operation output flag* to ON and forces the *Homing operation* to be done from the PLC when switching the type of the sampling movement.
 Specifically, the Sensor Controller will turn on the *Homing operation output flag* when switching between the translation sampling and the rotational movement sampling, and vice versa. The PLC after receiving the above command instructs the *Homing operation* to the conveyor or stage. This reduces the effect of positional shifting due to backlash associated with the movement of the conveyor or stage.
 If a highly precise stage or conveyor is being used or the effect of backlash is mitigated by some other means, you can select *Disable* for this function.
- Example for *Homing operation output*
 For example for *Homing operation output* depending on sampling settings, refer to the following table.

Sampling method: All at once

Sampling processing	Output flag (Homing operation selection: Enable)	Output flag (Homing operation selection: Disable)
Output after reference position sampling	OFF	OFF
Output of first translation position 1 sampling	OFF	OFF
Output of first translation position 2 sampling	ON	OFF
Output of first rotation moving position 1 sampling	ON	OFF
Output of translation position 1 sampling	OFF	OFF
Output of translation position 2 sampling	OFF	OFF
Output of translation position 3 sampling	ON	OFF
Output of rotation moving position 1 sampling	OFF	OFF
Output of rotation moving position 2 sampling	ON	OFF

Sampling method: One by one

Sampling processing	Output flag (Homing operating selection: Enable)	Output flag (Homing operating selection: Disable)
Output after reference position sampling	OFF	OFF
Output of first translation position 1 sampling	OFF	OFF
Output of first translation position 2 sampling	ON	OFF
Output of first rotation moving position 1 sampling	ON	OFF
Output after reference position sampling	OFF	OFF
Output of translation position 1 sampling	OFF	OFF
Output of translation position 2 sampling	OFF	OFF
Output of translation position 3 sampling	ON	OFF
Output of rotation moving position 1 sampling	OFF	OFF
Output of rotation moving position 2 sampling	ON	OFF

**Precautions for Correct Use**

- A moving amount after *Homing operation* is output when *Homing operation selection* is enabled after calibration is complete. When it is disabled, the moving amount from the current position to the next position is output.
- If an error occurred while Vision Master Calibration is performed, when the *Homing operation selection* is enabled, the Homing operation output flag is turned on and the moving amount is output as zero. When it is disabled, the Homing operation output flag is not changed and the moving amount is output as zero.

4-26-4 Sampling Setting (Vision Master Calibration)

Here sets data related to sampling.

Here also perform the sampling settings for the initial calibration and this calibration respectively. The settable contents depend on the type of a stage or robot selected in the *Stage Data* or *Robot Data*.

- 1 In the Item tab area, click **Sampling setting**.

- 2** In the *First calibration setting* area, set each item.
 Ex. : XYθ stage selected

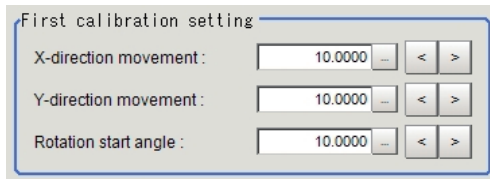

Setting item	Setting value [Factory default]	Description
X-direction movement	-99,999.9999 to 99,999.9999 [10.0000]	Sets the X axis movement amount in the in first calibration.
Y-direction movement	-99,999.9999 to 99,999.9999 [10.0000]	Sets the Y axis movement amount in the first calibration.
Y-direction movement	-180.0000 to 180.0000 [10.0000]	Sets the rotation movement start angle in the first calibration.



Additional Information

When you select X, Y, Xθ, Yθ, θX, or θY stage, non-existent axis will be grayed out and you cannot set it. Only existing axes can be set.

- The first calibration
 The first calibration collects and calculates calibration data to fined the movement range for this calibration.

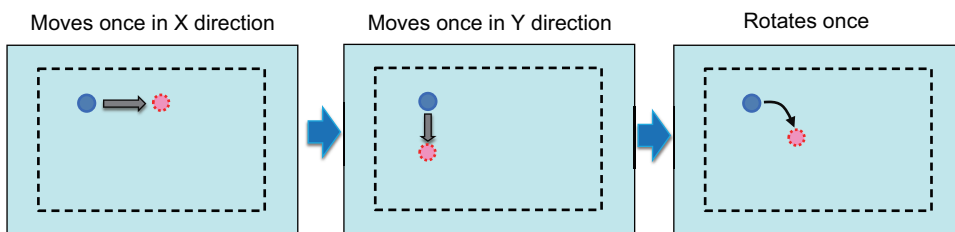

Additional Information

If the sampling for the first calibration failed, the sampling is going to be performed again with half of the movement amount and angle.

If a measurement position for sampling is out of the range of field of camera view due to large first movement amount, such movement amount and movement angle are automatically corrected to perform the sampling again.

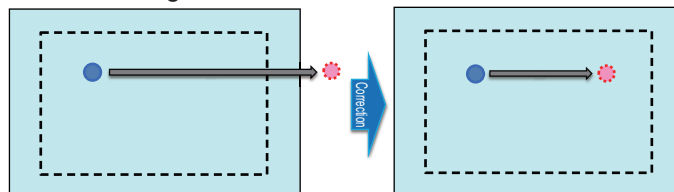

- 3** Set each item in this *Calibration setting* area.
 For this calibration, there are two sampling methods: *One by one* that is possible to generate up to 8 calibration data and *All at once* that is possible to generate all calibration data at once.

- One by one:
Since the field of view range is calculated per calibration data, the sampling measurement range becomes wider than *All at once*.
- All at once:
Since all calibration data is generated at once, the calibration data is generated faster than *One by one*.



Additional Information

- This calibration can be NG (an error) when a data measurement processing unit that is not the sampling target became NG. In this case, change the judgement expression in the *Calibration target* area in the calibration tab. Set the unit judgement JG for the measurement processing unit measuring the sampling target to each judgement expression for calibration data. By this, this calibration is processed successfully even if a measurement processing unit whose data is not the sampling target is judged as NG.
For details, refer to *4-26-4 Sampling Setting (Vision Master Calibration)* on page 4-149.
- In some case, appropriate measurement processing units have not been set to each calibration data.
In this case, adjust calibration after checking the error detection value and the maximum error detection value.
For details, refer to *Causes and measures when Error detection value and Maximum error detection value are large* on page 4-167.

1) When XY or X (Y) stages are selected in the *Stage Data*, or when the three-axis robot is selected in the *Robot Data*:

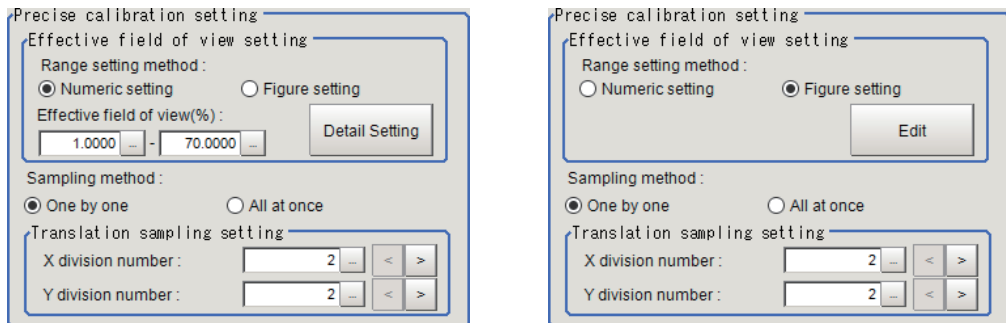

Setting item	Setting value [Factory default]	Description
Range setting method	<ul style="list-style-type: none"> • [Numeric setting] • Figure setting 	Sets the effective range of the field of view for the image input unit.
Effective field of view [%]	1 to 100 [1] to [70]	The setting is valid when <i>Numeric setting</i> is checked in Range setting . Sets the effective field of view for amount of sampling movement numerically based on the center of the field of view.
Edit	-	The setting is valid when <i>Figure setting</i> is checked in Range setting . Click the Edit button to open the Effective field of view detail setting dialog. Sets the effective viewing range for amount of sampling movement as a rectangle with respect to the input image.

Setting item	Setting value [Factory default]	Description
Sampling method	<ul style="list-style-type: none"> [One by one] All at once 	Selects whether to generate calibration data one by one or all at once.
Translation sampling setting	-	Translation sampling performs a sampling by moving a stage parallel to the X axis or Y axis. It consists of a row parallel to the X axis and a column parallel to the Y axis and an intersection of them will be the sampling point.
X division number	2 to 10 [5]	Sets the number of rows divided during translation sampling in this calibration.
Y division number	2 to 10 [5]	Sets the number of columns divided during translation sampling in this calibration.



Additional Information

When you select X(Y) stage and set X-axis as the movement axis, only *Y division number* can be applied. In this case, *X division number* is grayed out. When you select Y-axis to the movement axis, *Y division number* is grayed out.

- 2) When XYθ, θXY, UVW, or UVWR stages are selected in the *Stage Data* or when the four-axis robot is selected in the *Robot Data*:

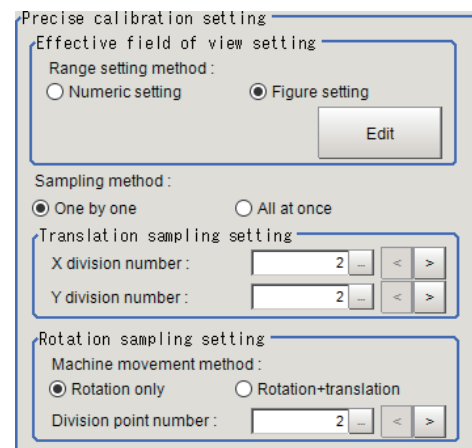
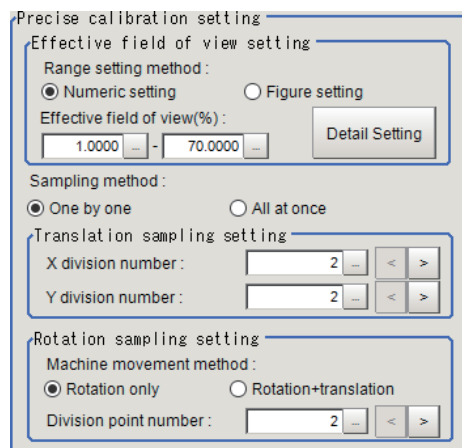

Setting item	Setting value [Factory default]	Description
Range setting method	<ul style="list-style-type: none"> [Numeric setting] Figure setting 	Sets the effective range of the field of view for the image input unit.
Effective field of view [%]	1 to 100 [1] to [70]	The setting is valid when <i>Numeric setting</i> is checked in Range setting . Sets the effective field of view for amount of sampling movement numerically based on the center of the field of view.
Edit	-	The setting is valid when <i>Figure setting</i> is checked in Range setting . Click the Edit button to open the Effective field of view detail setting dialog. Sets the effective viewing range for amount of sampling movement as a rectangle with respect to the input image.

Setting item	Setting value [Factory default]	Description
Sampling method	<ul style="list-style-type: none"> [One by one] All at once 	Selects whether to generate calibration data one by one or all at once.
Translation sampling setting	-	Translation sampling performs a sampling by moving a stage parallel to the X axis or Y axis. It consists of a row parallel to the X axis and a column parallel to the Y axis and an intersection of them will be the sampling point.
X division number	2 to 10 [5]	Sets the number of rows divided during translation sampling in this calibration.
Y division number	2 to 10 [5]	Sets the number of columns divided during translation sampling in this calibration.
Rotation sampling setting	-	-
machine moving method	<ul style="list-style-type: none"> [Rotation only] Rotation + translation 	Selects the external device movement method for rotational sampling in this calibration. This setting is grayed out and is not applied when you select <i>All at once</i> .
Division point number	2 to 100 [5]	Sets the number of division points for rotational sampling in this calibration.

3) When Xθ(Yθ) or θX(θY) stages are selected in the *Stage Data*:

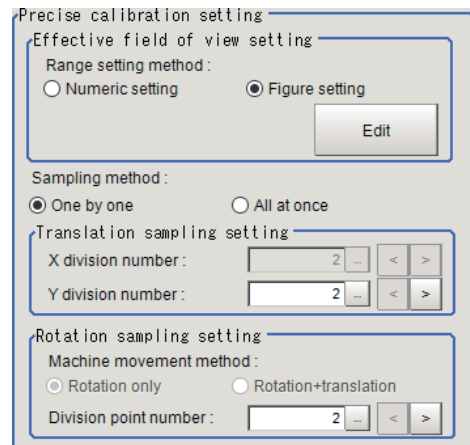
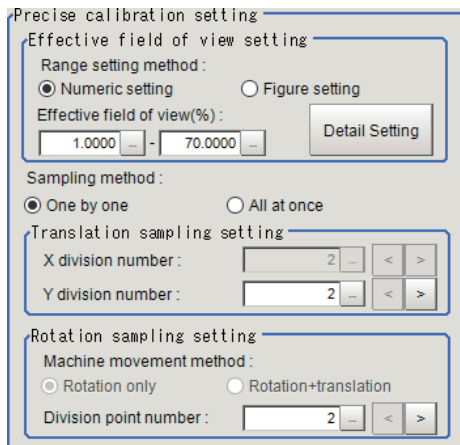

Setting item	Setting value [Factory default]	Description
Range setting method	<ul style="list-style-type: none"> [Numeric setting] Figure setting 	Sets the effective range of the field of view for the image input unit.
Effective field of view [%]	1 to 100 [1] to [70]	The setting is valid when <i>Numeric setting</i> is checked in Range setting . Sets the effective field of view for amount of sampling movement numerically based on the center of the field of view.

Setting item		Setting value [Factory default]	Description
	Edit	-	The setting is valid when <i>Figure setting</i> is checked in Range setting . Click the Edit button to open the Effective field of view detail setting dialog. Sets the effective viewing range for amount of sampling movement as a rectangle with respect to the input image.
	Sampling method	<ul style="list-style-type: none"> • [One by one] • All at once 	Selects whether to generate calibration data one by one or all at once.
	Translation sampling setting	-	Translation sampling performs a sampling by moving a stage parallel to the X axis or Y axis. It consists of a row parallel to the X axis and a column parallel to the Y axis and an intersection of them will be the sampling point.
	X division number	2 to 10 [5]	Sets the number of rows divided during translation sampling in this calibration.
	Y division number	2 to 10 [5]	Sets the number of columns divided during translation sampling in this calibration.
	Rotation sampling setting	-	-
	Division point number	2 to 100 [5]	Sets the number of division points for rotational sampling in this calibration.



Additional Information

When you select $X\theta(Y\theta)$ or $\theta X(\theta Y)$ stage and set X-axis as the movement axis, only *Y division number* can be applied. In this case, *X division number* is grayed out. When you select Y-axis to the movement axis, *Y division number* is grayed out.

4

Check whether or not the Effective field of view [%] set above is properly set.

The button label in the *Precise calibration* area and the dialog it launches differs depending on what is checked for the **Range setting method**. It is the **Detail Setting** button (when *Numeric setting* is checked) or the **Edit** button (when *Figure Set* is checked). When **Detail Setting** button is clicked, the following "Effective field of view" setting dialog opens.

In the *Image display* area, an image for the *Effective field of view confirm target*, set by the *Data No.*, is displayed. When <None> is displayed in the Detection unit No., the Effective field of view range is displayed with gray broken line as below.

- For Numeric setting:

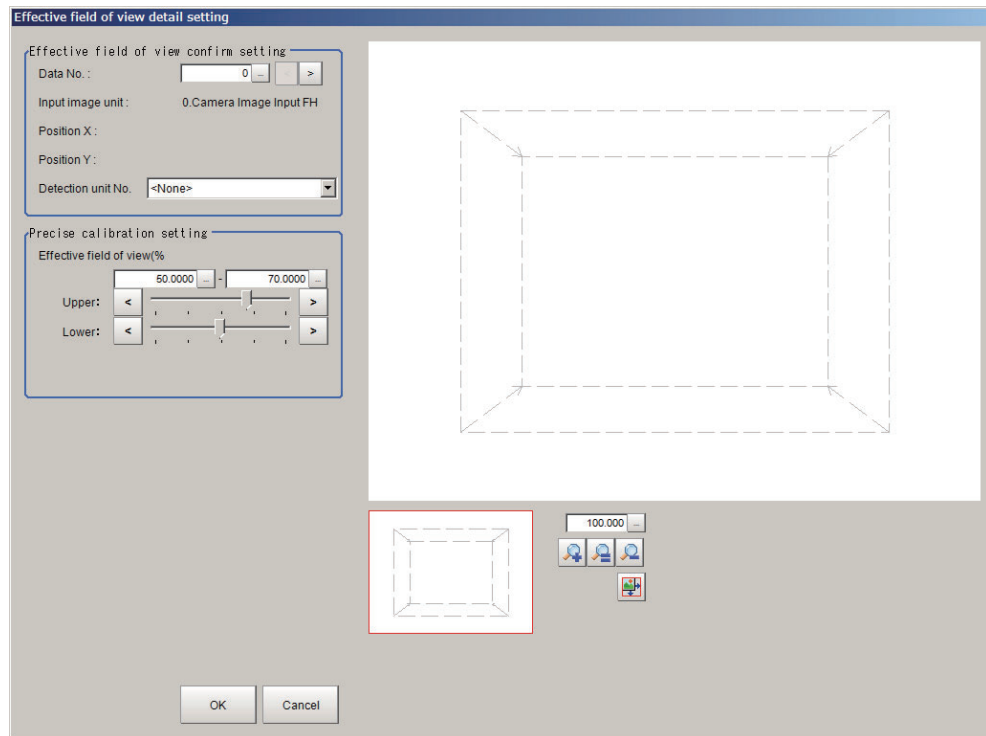

The dialog opened

Setting item	Setting value [Factory default]	Description
Effective field of view confirm setting	-	-
Data No.	0 to 7 [0]	Sets the <i>Effective field of view confirm target data</i> .
Input image unit	-	Displays the <i>Input image unit</i> set by the <i>Data No.</i>
Position X/Y	-	Displays the position X/Y of data set by the <i>Data No.</i>
Detection unit No.	<None> to 9,999 [None]	Sets the <i>Detection unit</i> for the Effective field of view confirm target. The detection points and model frame for the input image unit will be displayed. The detection points are overlapped on four vertexes of the effective field of view.
Precise calibration setting	-	-
Effective field of view [%]	1 to 100 [1] to [70]	Sets the effective range of the field of view for the image input unit.

- For Figure Set:

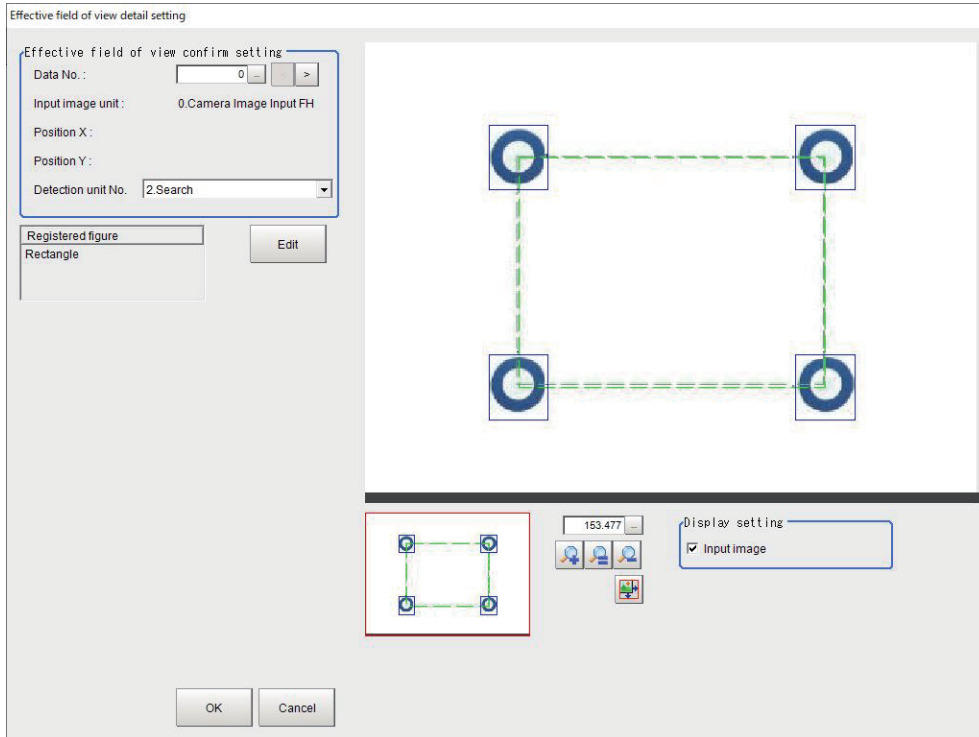

Setting item	Setting value [Factory default]	Description
Effective field of view confirm setting	-	-
Data No.	0 to 7 [0]	Sets the <i>Effective field of view confirm target</i> data.
Input image unit	-	Displays the <i>Input image unit</i> set by the <i>Data No.</i>
Position X/Y	-	Displays the position X/Y of data set by the <i>Data No.</i>
Detection unit No.	<None> to 9,999 [None]	Sets the <i>Detection unit</i> for the Effective field of view confirm target. The detection points and model frame for the input image unit will be displayed. The detection points are overlapped on four vertexes of the effective field of view.
Registered figure	-	Set the effective field of view of the image input unit as a rectangle.



Precautions for Correct Use

When setting Effective field of view for **Figure Set**, if the center of the field of view does not fall within the set range, an error will occur during measurement.

Display example:

- 1) Effective field of view confirm range target: Sets a detection unit (in the case where the position of the model frame is within the range of the image field of view.
The upper and lower limit values are displayed with green broken lines. Those values are also connected with green broken lines. There is no lower limit for Figure Set.
The detection position and the model frame are displayed with solid lines.

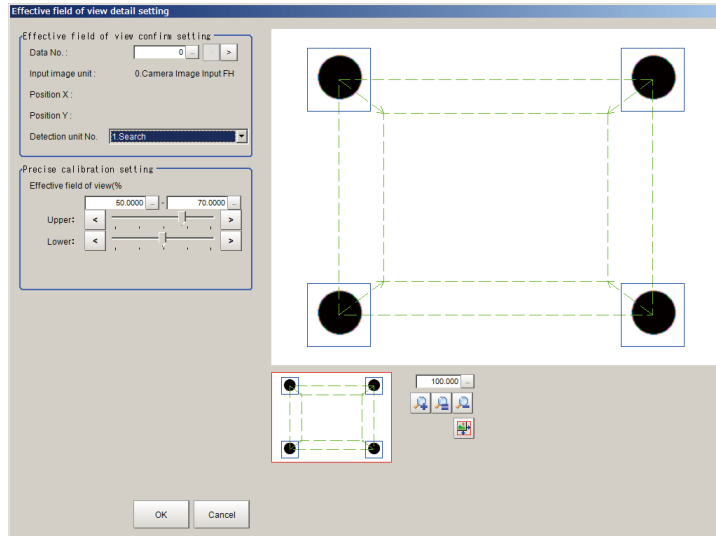

- 2) Effective field of view range confirm target: Sets a detection unit (in the case where the position of the model frame is out of the range of the image field of view).

When the model frame is out of the range of the image field of view, the upper limit value for the *Effective field of view* is displayed with red broken lines. The detection points and model frame for the input image unit will be also displayed on four corners in the Image window.

In the *Precise calibration setting* area, the following warning message is displayed *Sampling NG may occur. Please narrow upperRange.*

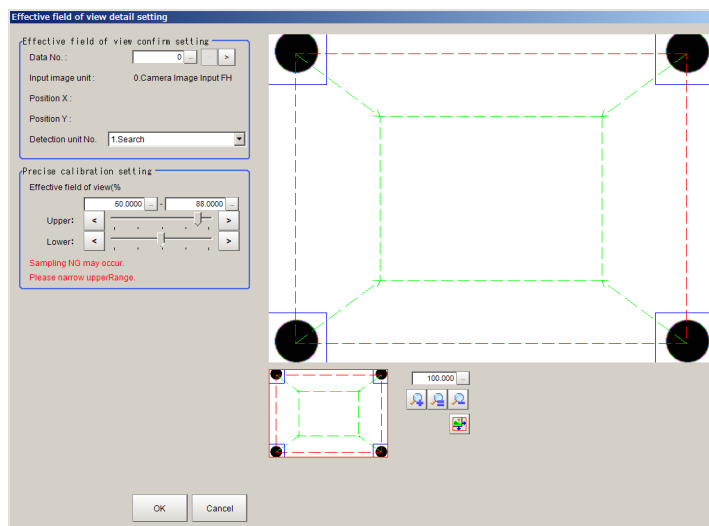

- 5 Set each item in the *Advanced setting* area as necessary.

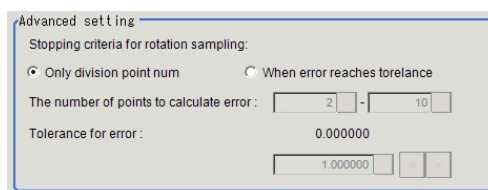

Setting item	Setting value [Factory default]	Description
Stopping criteria for rotation sampling	<ul style="list-style-type: none"> • Only division point num • [When error reaches tolerance] 	Selects the end condition for rotational movement sampling in this calibration.
The number of points to calculate error	2 to 100 [6] to [15]	<i>When error reaches tolerance</i> is selected, calculates error within the range of <i>The number of points to calculate error</i> .
Tolerance for error	0 to 99,999.999999 [0.230000]	Sets the upper limit value for the error detection.

The movement amount necessary for sampling measurement:

Movement amount necessary for sampling measurement is calculated using the number of divided lines (N) and the number divided lines (M).

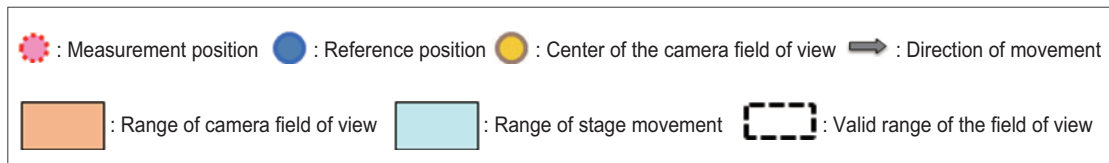

Number of movement points = $N \times M$

Number of movement times = The number of calibration data items checked in the *Calibration target*.

When the translation sampling at One by one is selected:

- The sampling is performed per camera used.
- The sampling moving amount is calculated to make it the maximum by the number of movement points set in translation sampling settings and the effective view range of the camera.
- The reference position is the axis position of the center of the field of view.

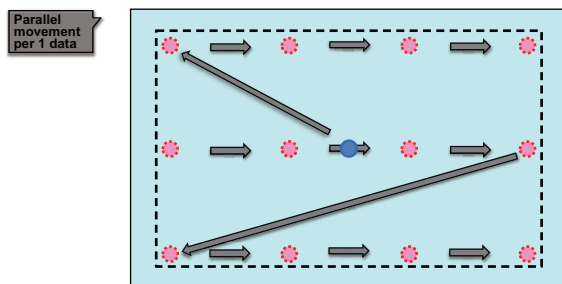

Number of movement points = $N \times M$

Number of movement times = 1

When the translation sampling at *All at once* is selected:

- Samples all data at once movement.
- The sampling moving range is calculated to make it the maximum by the number of movement points set in the translation sampling setting and the effective field of view range in the first calibration. Note that the motion is different from *One by one* sampling method.
- The reference position will be the axis position at the calibration start.

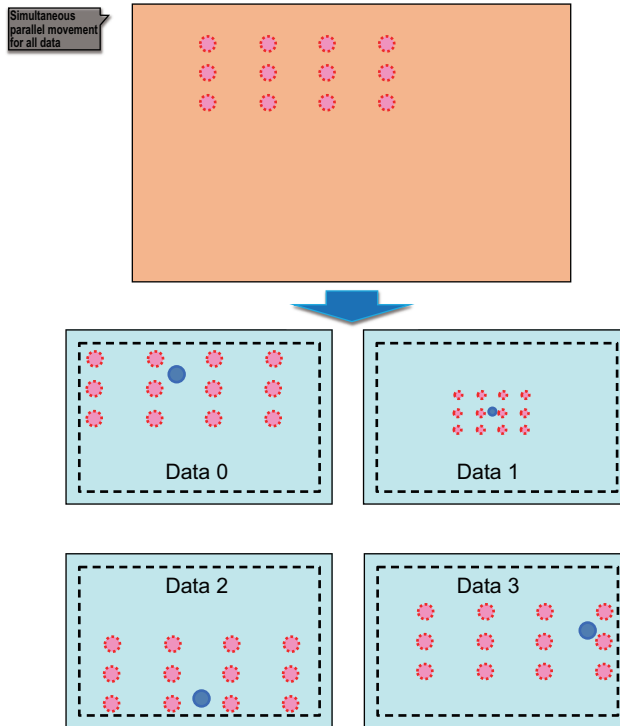

Number of movement points = Number of division points

Number of movement times = The number of calibration data items checked in the *Calibration target*.

When the rotational movement sampling at One by one is selected:

- The sampling is performed per camera used.
- First, moves to the center of the field of view because the accuracy of the camera image is high in center.
- The sampling moving amount is calculated to make it the maximum by the number of movement points in rotation sampling setting and the effective view range of the camera.
- The reference position will be the axis position at the calibration start.

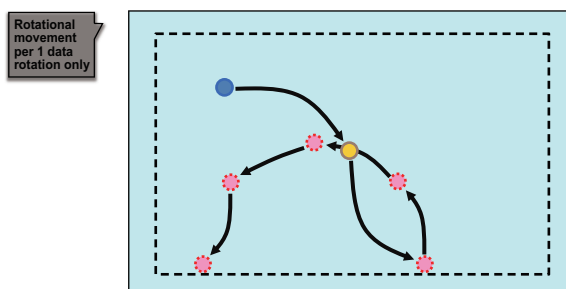

Number of movement points = Number of division points

Number of movement times = The number of calibration data items checked in the *Calibration target*.

When the translation sampling and rotational movement sampling at One by one are selected:

- The sampling is performed per camera used.
- In the case of the translation and rotation movement samplings, the translation sampling is performed after performing the rotation movement sampling and moving to the axis position of the center of the field of view.

- The sampling moving amount is calculated to make it the maximum by the number of movement points set in the translation and the rotation sampling settings and the effective view range of the camera.
- The reference position will be the axis position at the calibration start.

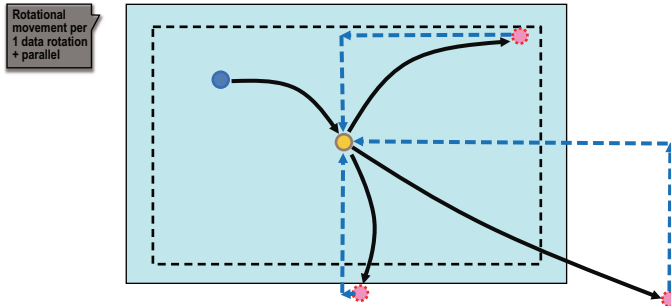

Number of movement points = Number of division points
 Number of movement times = 1

When the rotational movement sampling at All at once is selected:

- Samples all data at one movement.
- The sampling moving range is automatically calculated to make it the maximum by the number of movement points set in the rotation sampling setting and the effective field of view range of the camera.
- The reference position will be the axis position at the calibration start.

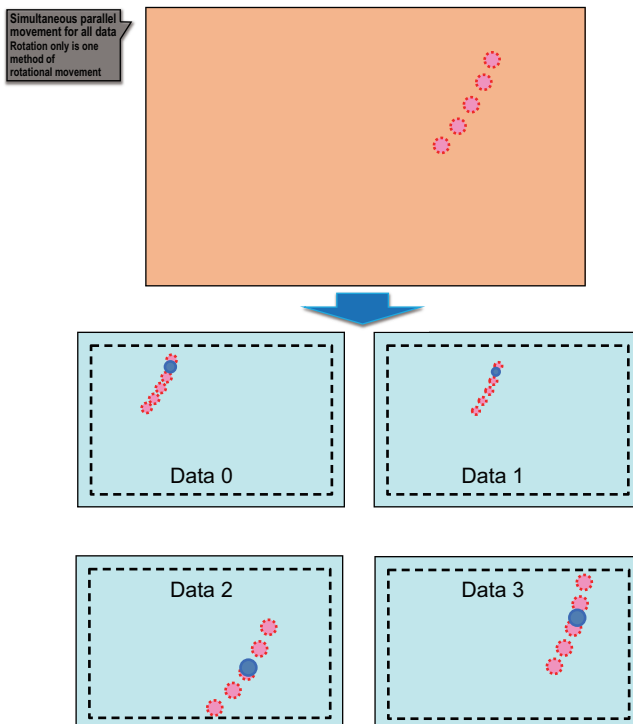

6 If necessary, set the rotation angle in **Robot rotation move limit setting**.

You can change the calculation range of rotation sampling.

This setting is enabled when the robot type selected in the Machine setting step is *Four axis (XYZR)* or *Six axis (XYZRWPR)*.

Robot rotation move limit setting

Rotation move limit positive :

Rotation move limit negative :

Setting item	Setting value [Factory default]	Description
Rotation move limit positive	0 to 180 [90]	Sets the Rotation move limit positive.
Rotation move limit negative	0 to 180 [90]	Sets the Rotation move limit netgative.

The Rotation move limit positive and Rotation move limit negative are angles relative to the axis position at the start of calibration as shown in the following figure.

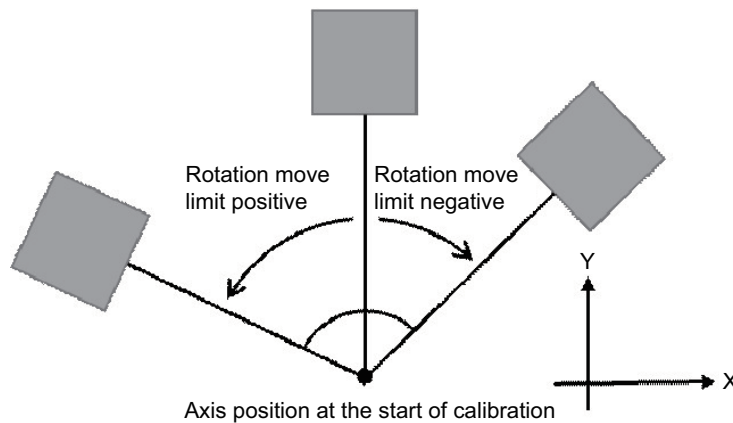

- 7** In the *Initial axis position* area, specify the starting axis position of each axis with expressions. The axis position setting menu changes depending on the settings of the processing unit selected in *Unit No.* in the **Machine setting data** area. If the workpiece used for sampling is out of the camera field of view in the return to origin position (all axes in 0,0 position), set the axis position after moving as the starting axis position. Ex. : When XYθ stage is selected in the *Stage Data*

Initial axis position

X-axis :

Y-axis :

θ-axis :

Causes and measures when the error evaluation value and the maximum error are large:
When the workpiece to use for sampling is out of the camera field of view at its origin return position (axis movement amount is 0).

- 8** In the *Final axis position* area, set the axis position for each axis at the time of calibration completed. Set each axis position to calculate movement amounts with the radio button when the calibration is completed or failed.

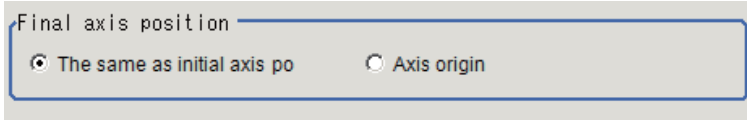

Setting item	Setting value [Factory default]	Description
Final axis position	<ul style="list-style-type: none"> [The same as initial axis po] Axis origin 	<ul style="list-style-type: none"> The same as initial axis po: Calculates the movement amount by setting the axis position the calibration started as the next movement position when the calibration is completed or failed. Axis origin: Calculates the movement amount by setting the next movement position as the axis origin when the calibration is completed or failed.

Note: In the compatible mode, *Axis origin* is the default.

Usage example:

When the workpiece to use for sampling is out of the camera field of view at its origin return position (axis movement amount is 0).

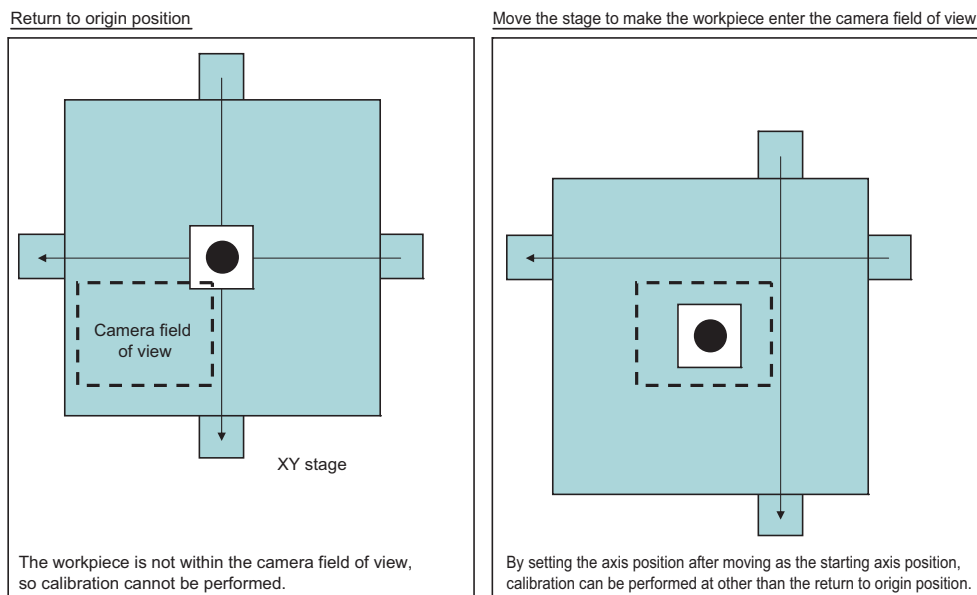

4-26-5 Calibration Result (Vision Master Calibration)

Check the calibration data created. To fine-tune the calibration data directly, use *Edit* function. It is also possible to confirm the sampling data used for the calibration. Displayed contents vary depending on the type of selected stage or robot in the *Stage Data* or *Robot Data*.

- 1** In the Item tab area, click **Calibration result**.
- 2** Check the calibration data generated.

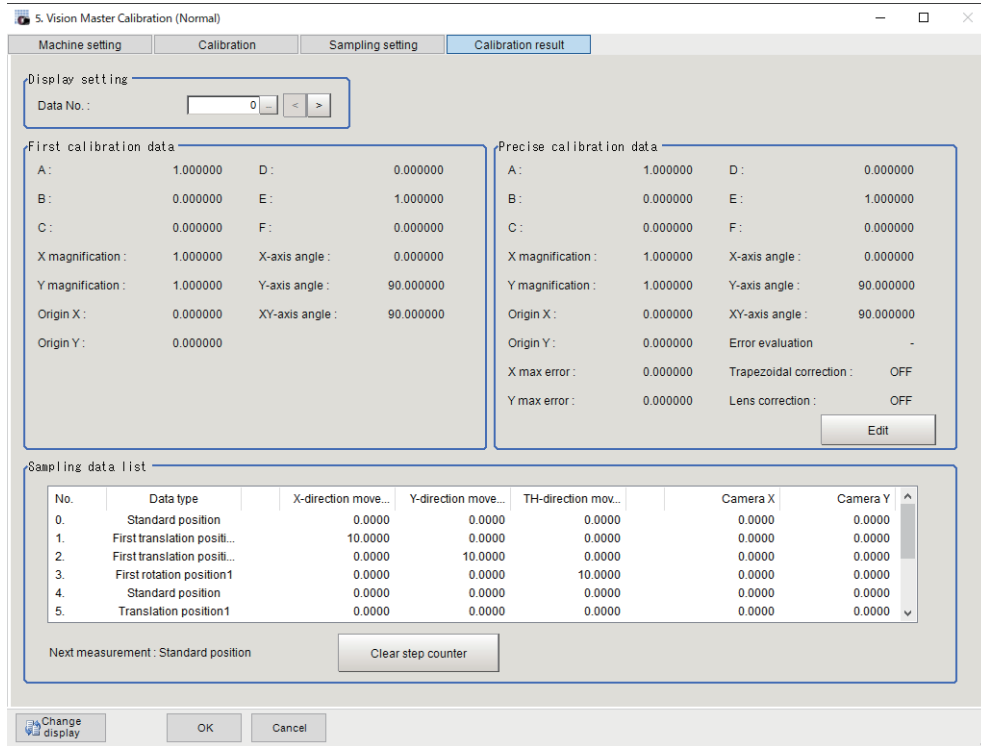

Setting item	Setting value [Factory default]	Description
Data No.	0 to 7 [0]	Sets the calibration data number displaying the calculation results.

Item	Description
First calibration data	Displays details of the first calibration parameters.
Precise Calibration data	Displays details of the calibration data.
A to F	Displays details about the calibration parameters. Click Edit enable will let you change the number for A to F. When any number has been changed, a message of <i>This data has been edited.</i> appears at the left of Edit enable .
X magnification	Indicates a magnification of X-axis direction for the coordinate system after calibration.
Y magnification	Indicates a magnification of Y-axis direction for the coordinate system after calibration.
X-axis angle	Indicates an angle formed between X-axis of the camera coordinate system and X-axis of the coordinate system after calibration.
Y-axis angle	Indicates an angle formed between Y-axis of the camera coordinate system and Y-axis of the coordinate system after calibration.
Origin X	Indicates an origin X of the coordinate system after calibration.
Origin Y	Indicates an origin Y of the coordinate system after calibration.
XY axis angle	Indicates an angle formed between X-axis and Y-axis of the coordinate system after calibration.
Error evaluation	The maximum distance value of the reference position calculated by the reference position and sampling result. When no θ -axis is in a stage, “-” is displayed because the calculation is impossible.

Item		Description
	X max error	Maximum displacement of X-axis direction between a position coordinate calculated by calibration and a sampling position coordinate. When no X-axis is in a stage, "-" is displayed because the calculation is impossible.
	Y max error	Maximum displacement of Y-axis direction between a position coordinate calculated by calibration and a sampling position coordinate. When no Y-axis is in a stage, "-" is displayed because the calculation is impossible.
	Trapezoidal distortion	The setting items displayed (checked or unchecked) in the Distortion type area on the tab.
	Lens distortion	
Sampling data list		Displays sampling data used for generating the calibration parameters. The data is movement amounts in X/Y/ θ directions from the reference position and the camera coordinate values. The reference position of No. 0 is an axis position at the first calibration started. When <i>One by one</i> is selected, the reference position is reset before the Precise calibration performed. When X θ , Y θ , θ X, θ Y, X, or Y stage is selected, the value for non-existing axis direction is always 0.
Clear step counter button		Sends back the next measurement target to the reference position and restarts calibration from the beginning

● Error detection values

This value is an index for confirming the accuracy of calibration results.

Output the error detection values when a stage has θ -axis.

This value is calculated by using "calibration data calculated in Vision master calibration" and "measurement results in rotation movement sampling".

If a problem in magnification, axis angle, or center position of rotation exists, the value will be large. In the following example, describe the calculation method in the case where the number of times for sampling is 2.

1. Perform the rotation sampling based on sampling settings. A reference position varies depending on the sampling method.

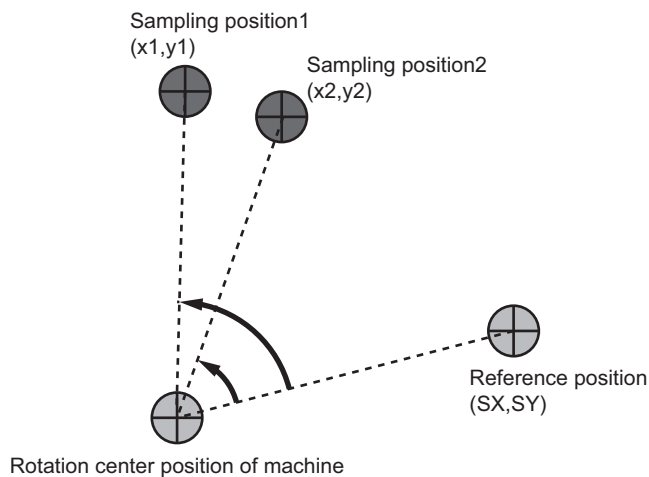

2. Calculate the rotation center position using the sampling results.

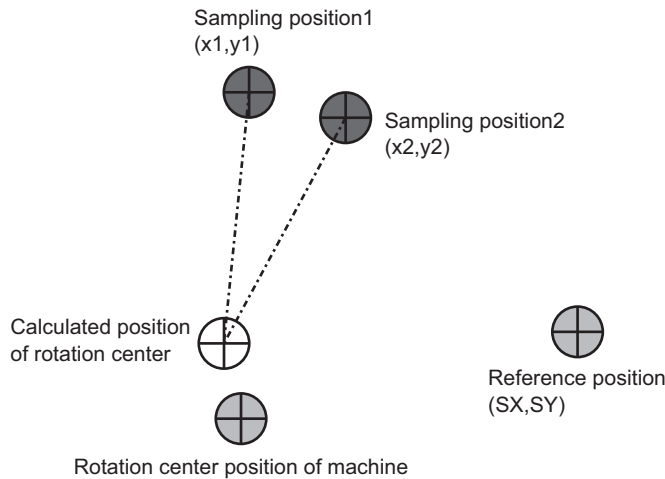

3. Calculate the reversed rotation positions from the calculated rotation center position per each position sampled.

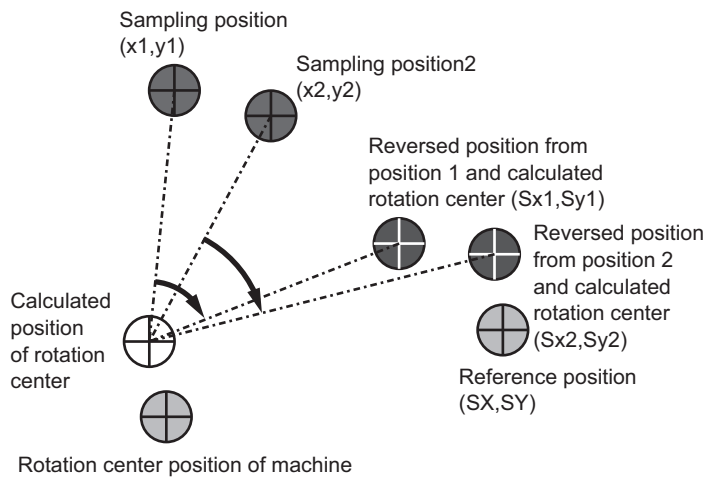

4. Calculate the absolute distance between the reference position and each reverse rotation position.
5. The maximum absolute distance is defined as the error detection value. A maximum value of X coordinate side is defined as X maximum error detection value and Y coordinate side is the same as X coordinate side. If there is a deviation in the calibration results or the calculated rotation center position, the reverse rotation positions are far from the reference position and the error detection values become large.

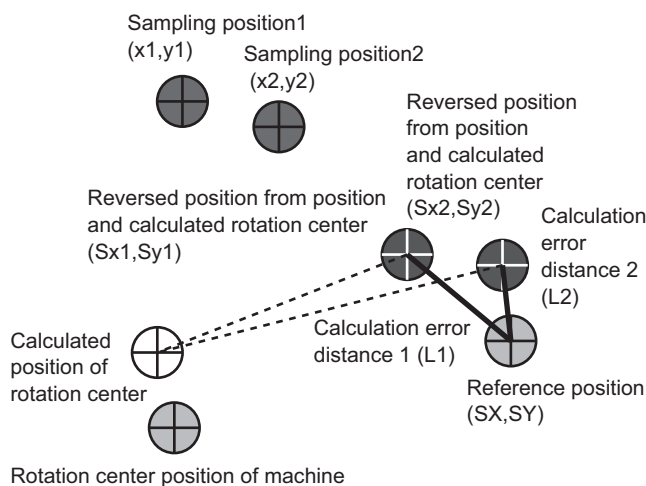

● **Maximum error detection values**

This value is an index for confirming the accuracy of calibration results.

Output X and Y maximum error detection values when a stage has X- or Y-axis.

X/Y maximum error detection values are calculated by using "calibration data calculated in Vision master calibration" and "measurement results in translation sampling".

If a problem in magnification, axis angle, or center position of rotation exists, the value will be high.

1. Perform the translation sampling based on sampling settings. A reference position varies depending on the sampling method.

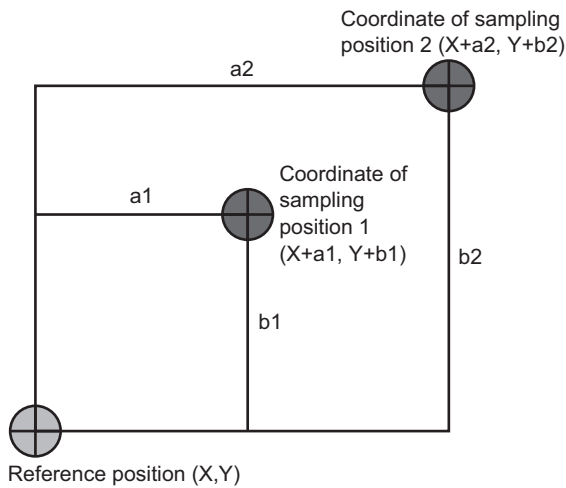

2. Perform sampling measurement.

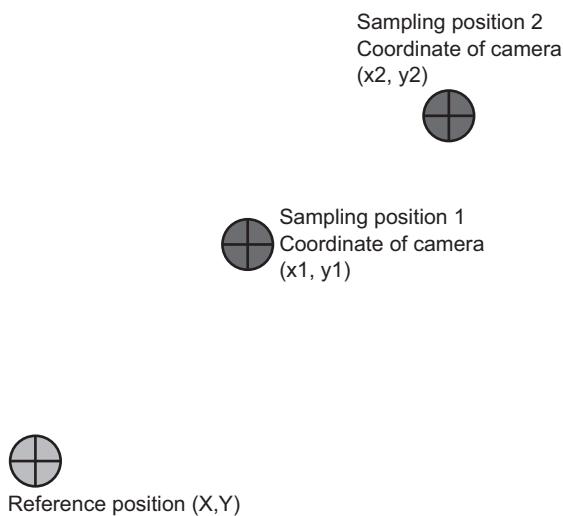

3. Perform a calibration according to sampling results and convert the sampling position to the real coordinates.

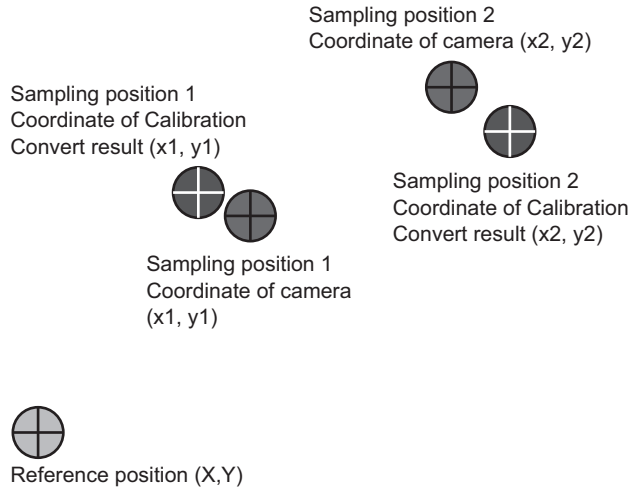

4. Calculate absolute values for differences between the calibration conversion results and coordinates of each sampling position.
5. Define the maximum value of X coordinate side as X max error, and the maximum value of Y coordinate side as Y max error.

X max error is given the larger value of $[X + a1 - X1]$ or $[X + a2 - X2]$.

Y max error is given the larger value of $[Y + b1 - Y1]$ or $[Y + b2 - Y2]$.

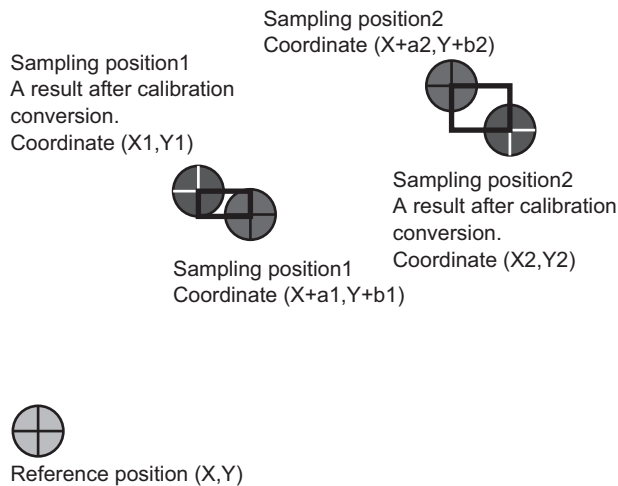

● **Causes and measures when Error detection value and Maximum error detection value are large**

If Error detection value or Maximum error detection value is bigger than the required accuracy of applications, refer to the following table to take measures.

The error value can be large when the sampling measurement failed. In this case, check whether the measurement judgement is OK.

Moreover, the error value varies depending on Stage, Robot, installation conditions, or loading conditions.

In this case, check the operation conditions.

Maximum error value of X(Y)	Error detection value	Causes and measures
Large	Large	<p>The accuracy of magnification, axis angle, or center position of rotation is sometimes insufficient.</p> <p>Check whether all the sampling measurements have been succeeded.</p> <p>Check that the setting contents for robot or stage have matched the data of robot or stage being used.</p> <p>Review the setting contents for the rotation movement sampling and the translation sampling based on the sampling measurement results.</p> <p>Check the measurement results for the rotation movement sampling and the translation sampling.</p> <ul style="list-style-type: none"> Refer to 4-35-1 Data Setting (Stage Data) on page 4-268 Refer to 4-26-4 Sampling Setting (Vision Master Calibration) on page 4-149 Refer to 4-26-5 Calibration Result (Vision Master Calibration) on page 4-162
Small	Large	<p>In some cases, the accuracy of the rotation center position may be insufficient.</p> <p>Check whether all the sampling measurements have been succeeded.</p> <p>Check that the setting contents for robot or stage have matched the data of robot or stage being used.</p> <p>Check the measurement results for the rotation movement sampling.</p> <ul style="list-style-type: none"> Refer to 4-35-1 Data Setting (Stage Data) on page 4-268 Refer to 4-26-4 Sampling Setting (Vision Master Calibration) on page 4-149 Refer to 4-26-5 Calibration Result (Vision Master Calibration) on page 4-162

4-26-6 Key Points for Test Measurement and Adjustment (Vision Master Calibration)

The following content is displayed in the *Detail result* area as text.

Displayed item	Description
Judge	<p>Judgment results</p> <p>0: No judgment (unmeasured)</p> <p>1: Judgment result OK</p> <p>-1: Judgment result NG</p> <p>-10: Error (image format mismatch)</p> <p>-11: Error (unregistered model)</p> <p>-12: Error (insufficient memory)</p> <p>-20: Error (other errors)</p>
Next measurement	Next measurement target
NG cause	<p>Displayed only when Judgment is NG</p> <p>-1: Setting NG</p> <p>-2: Sequence NG</p> <p>-3: Mobility NG</p> <p>-4: Calibration NG</p> <p>-5: Evaluation NG</p> <p>-6: Sampling NG</p> <p>-7: Effective field of view range NG</p> <p>-100: Other NG</p>

The image specified in the Sub-image number in the image display setting is displayed in the *Image Display* area.

Sub-image number	Description of image to be displayed
0	Measurement image + calibration progress status
1	Measurement image only

Key Points for Adjustment (Vision Master Calibration)

Adjust the setting parameters referring to the following points.

● While executing calibration

Parameter to be adjusted	Remedy
Refer to "Remedy"	<p>When unit judgement NG occurred during calibration, confirm the <i>NG cause</i> appears in the detail result pane and perform appropriate countermeasures.</p> <ul style="list-style-type: none"> • Setting NG The processing item setting is not correct. Check if the settings are correct including the processing items being referred to. • Sequence NG Measurement is executed regardless of whether calibration has been completed. Be sure that no measurement is performed when the calibration completion flag is 1. • Mobility NG The axis movement range is not correct. Check if the stage data being referred to and the movement range of the robot data are correct. • Calibration NG Calibration data calculation has failed. Check if the camera coordinates in the sampling data list in the Calculation Result Confirmation Tab are set correctly. If any data is set incorrectly, the processing items used in measurement may not be set properly. Check that the settings are correct. • Evaluation NG If the end condition of the rotational sampling is "The error detection value is lower than the setting value," the error detection value is not lower than the setting value when the upper limit values for the number of measurement points are measured. Adjust the overall flow setting, for example, by using the average of multiple measurement results to improve the measurement accuracy. • Sampling NG The sampling measurement has failed. Adjust the setting data so that the processing items used in the measurement is not NG. If it still continues to occur, the judgement formula and condition may not be set correctly. Check that the settings are correct. • Effective field of view range NG The model frame exceeds the <i>effective field of view range</i>. Adjust the upper limit of model frame so that the <i>effective field of view range</i> will be within the proper range.
Calculation result confirmation	To start all over again, click Clear step counter or execute the measurement result clearing.

● Others

Parameter to be adjusted	Remedy
Machine settings	<p>When the selection cannot be performed because the reference unit No. is <none>, check if the reference scene number is selected correctly. Check if stage data processing items or robot data processing items are registered in the selected reference scene.</p> <p>The reference unit number does not change during flow editing, which is the specifications.</p> <p>While a scene other than the current scene is referenced, the reference unit number does not change according to the editing of the flow. Change the flow so that the current scene will be referenced, or set the reference unit number again.</p>

4-26-7 Measurement Results for Which Output Is Possible (Vision Master Calibration)

The following values can be output using processing items related to result output. It is also possible to reference measurement values from calculation expressions and other processing units.

Measurement items	Character string	Description
Judge	JG	Judgment results 0: No judgment (unmeasured) 1: Judgment result OK -1: Judgment result NG -10: Error (image format mismatch) -11: Error (unregistered model) -12: Error (insufficient memory) -20: Error (other errors)
Origin return flag	ORIF	Origin return flag
Calibration end flag	ENDF	Calibration end flag
Error evaluation value X	EX	Error evaluation value X
Error evaluation value Y	EY	Error evaluation value Y
Next X axis movement	NMX	Next X axis movement
Next Y axis movement	NMY	Next Y axis movement
Next θ axis movement	NMT	Next θ axis movement
Next θ axis (Linear Drive) movement	NML	Next θ axis (Linear Drive) movement
Next U axis movement	NMU	Next U axis movement
Next V axis movement	NMV	Next V axis movement
Next W axis movement	NMW	Next W axis movement
Next R axis movement	NMR	Next R axis movement
NG cause	CNG	NG cause -1: Setting NG -2: Sequence NG -3: Mobility NG -4: Calibration NG -5: Evaluation NG -6: Sampling NG -7: Effective field of view range NG -100: Other NG

4-26-8 External Reference Tables (Vision Master Calibration)

No.	Data name	Data ident	Set/Get	Data range
0	Judge	judge	Get only	0: No judgment (unmeasured), 1: Judgment result OK, -1: Judgment result NG
6	Origin return flag	calibOrignFlag	Get only	0 to 1
7	Calibration end flag	calibEndFlag	Get only	0 to 1
8	Error evaluation X	errorX	Get only	0 to 99,999.9999
9	Error evaluation Y	errorY	Get only	0 to 99,999.9999
10	Next X-axis Movement	nextMoveX	Get only	-
11	Next Y-axis Movement	nextMoveY	Get only	-
12	Next θ -axis Movement	nextMoveTheta	Get only	-
13	Next θ -axis (Linear Drive) Movement	nextMoveLinearTheta	Get only	-
14	Next U-axis Movement	nextMoveU	Get only	-
15	Next V-axis Movement	nextMoveV	Get only	-
16	Next W-axis Movement	nextMoveW	Get only	-
17	Next R-axis Movement	nextMoveR	Get only	-
18	Next Calibration Operation	calibStepKind	Get only	-
19	Calibration step No.	calibStepNo	Get only	-
20	NG cause	errorCode	Get only	-
21	Data no.	dataNo	Get only	-
23	Next Yaw-axis movement	nextMoveYaw	Get only	-
24	Next Pitch-axis movement	nextMovePitch	Get only	-
25	Next Roll-axis movement	nextMoveRoll	Get only	-
123	Scene No.	sceneNo	Set/Get	-1: Current scene referred 0 to 9,999: Pointed scene referred
124	Unit No.	unitNo	Set/Get	-1: No reference 0 to 9,999: Pointed unit referred
128	movement output method	axisCalcType	Set/Get	0: Absolute position 1: Relative position
137	First calibration movement X	moveX	Set/Get	-99,999.9999 to 99,999.9999
138	First calibration movement Y	moveY	Set/Get	-99,999.9999 to 99,999.9999
139	First calibration rotation start angle	StartAngle	Set/Get	-180.0000 to 180.0000
141	Sampling method	samplingType	Set/Get	0: One by one, 1: All at once

No.	Data name	Data ident	Set/Get	Data range
142	X division number	paraRowNum	Set/Get	2 to 10
143	Y division number	paraColNum	Set/Get	2 to 10
144	Division point number	rotDivideNum	Set/Get	2 to 100
145	Machine movement method	rotMovementType	Set/Get	0: Rotation only 1: Rotation+translation
146	Homing operation selection	originFlagEnable	Set/Get	0: Disable, 1: Enable
148	Range setting method	rangeSettingType	Set/Get	0: Numeric setting 1: Figure Set
150	Calibration start X-axis position	currentPosX	Set/Get	Exp. character string
151	Calibration start Y-axis position	currentPosY	Set/Get	Exp. character string
152	Calibration start θ -axis angle position	currentPosTheta	Set/Get	Exp. character string
153	Calibration start θ -axis (linear drive) position	currentPosLinear-Theta	Set/Get	Exp. character string
154	Calibration start U-axis position	currentPosU	Set/Get	Exp. character string
155	Calibration start V-axis position	currentPosV	Set/Get	Exp. character string
156	Calibration start W-axis position	currentPosW	Set/Get	Exp. character string
157	Calibration start R-axis position	currentPosR	Set/Get	Exp. character string
158	Making flag of trapezoidal distortion correction parameter	trapezoidalCorrect-Flag	Set/Get	0:No 1:Yes
159	Making flag of lens distortion correction parameter	distortionCorrectFlag	Set/Get	0: No, 1: Yes
160	Stopping criteria for rotation sampling	rotEndCondition	Set/Get	0: Only division point num 1: When error reaches tolerance
161	Min number of points to calculate error	errorCalMin	Set/Get	2 to 100
162	Max number of points to calculate error	errorCalMax	Set/Get	2 to 100
163	Upper limit of rotation center error evaluation	maxErrorCenter	Set/Get	0 to 99,999.999999
164	Lower limit of effective field of view	lowerRange	Set/Get	1 to 100
165	Upper limit of effective field of view	upperRange	Set/Get	1 to 100
166	Final axis position	endPosFlag	Set/Get	0: The same as initial axis position, 1: Axis origin
168	Display data No.	dispDataNo	Set/Get	0 to 7

No.	Data name	Data ident	Set/Get	Data range
170	Calibration start Yaw-axis position	currentPosYaw	Set/Get	Exp. character string
171	Calibration start Pitch-axis position	currentPosPitch	Set/Get	Exp. character string
172	Calibration start Roll- axis position	currentPosRoll	Set/Get	Exp. character string
173	Rotation movement limit positive	rotMoveLimitPositive	Set/Get	0 to 180
174	Rotation movement limit negative	rotMoveLimitNega- tive	Set/Get	0 to 180
200+N×10 (N=0 to 7)	Calibration target flag	exeFlag0 to exe- Flag7	Set/Get	0: No, 1: Yes
201+N×10 (N=0 to 7)	Position X	expCameraX0 to exp- CameraX7	Set/Get	Exp. character string
202+N×10 (N=0 to 7)	Position Y	expCameraY0 to exp- CameraY7	Set/Get	Exp. character string
203+N×10 (N=0 to 7)	Sampling judge ex- pression	expJudgeSampling0 to expJudgeSam- pling7	Set/Get	Exp. character string
204+N×10 (N=0 to 7)	Sampling judge up- per	upperJudgeSam- pling0 to upperJudg- eSampling7	Set/Get	-999,999,999.9999 to 999,999,999.9999
205+N×10 (N=0 to 7)	Sampling judge low- er	lowerJudgeSam- pling0 to lowerJudg- eSampling7	Set/Get	-999,999,999.9999 to 999,999,999.9999
206+N×10 (N=0 to 7)	Input image no.	imageUnitNo0 to im- ageUnitNo7	Set/Get	-1: None 0 to 9,999: Unit No.
207+N×10 (N=0 to 7)	Detection unit No.	unitNoDetection0 to unitNoDetection7	Set/Get	-1:None 0 to 9,999: Unit No.
5,009	Clear step counter	clearStepCounter	Set only	1: Clear
11,301+N×10,00 0 (N=0 to 7)	First calibration pa- rameter A	calibParamFirstA_0 to calibParam- FirstA_7	Get only	-99,999.999999 to 99,999.999999
11,302+N×10,00 0 (N=0 to 7)	First calibration pa- rameter B	calibParamFirstB_0 to calibParam- FirstB_7	Get only	-99,999.999999 to 99,999.999999
11,303+N×10,00 0 (N=0 to 7)	First calibration pa- rameter C	calibParamFirstC_0 to calibParam- FirstC_7	Get only	-99,999.999999 to 99,999.999999
11,304+N×10,00 0 (N=0 to 7)	First calibration pa- rameter D	calibParamFirstD_0 to calibParam- FirstD_7	Get only	-99,999.999999 to 99,999.999999
11,305+N×10,00 0 (N=0 to 7)	First calibration pa- rameter E	calibParamFirstE_0 to calibParam- FirstE_7	Get only	-99,999.999999 to 99,999.999999
11,306+N×10,00 0 (N=0 to 7)	First calibration pa- rameter F	calibParamFirstF_0 to calibParam- FirstF_7	Get only	-99,999.999999 to 99,999.999999
11,307+N×10,00 0 (N=0 to 7)	First X magnification	firstScaleX_0 to first- ScaleX_7	Get only	-

No.	Data name	Data ident	Set/Get	Data range
11,308+N×10,000 (N=0 to 7)	First Y magnification	firstScaleY_0 to firstScaleY_7	Get only	-
11,309+N×10,000 (N=0 to 7)	First origin X	firstCenterX_0 to firstCenterX_7	Get only	-
11,310+N×10,000 (N=0 to 7)	First origin Y	firstCenterY_0 to firstCenterY_7	Get only	-
11,311+N×10,000 (N=0 to 7)	First X-axis angle	firstAngleX_0 to firstAngleX_7	Get only	-
11,312+N×10,000 (N=0 to 7)	First Y-axis angle	firstAngleY_0 to firstAngleY_7	Get only	-
11,313+N×10,000 (N=0 to 7)	First XY-axis angle	firstAngleXY_0 to firstAngleXY_7	Get only	-
14,001+N×10,000 (N=0 to 7)	Calibration parameter A	calibParamA_0 to calibParamA_7	Set/Get	-99,999.999999 to 99,999.999999
14,002+N×10,000 (N=0 to 7)	Calibration parameter B	calibParamB_0 to calibParamB_7	Set/Get	-99,999.999999 to 99,999.999999
14,003+N×10,000 (N=0 to 7)	Calibration parameter C	calibParamC_0 to calibParamC_7	Set/Get	-99,999.999999 to 99,999.999999
14,004+N×10,000 (N=0 to 7)	Calibration parameter D	calibParamD_0 to calibParamD_7	Set/Get	-99,999.999999 to 99,999.999999
14,005+N×10,000 (N=0 to 7)	Calibration parameter E	calibParamE_0 to calibParamE_7	Set/Get	-99,999.999999 to 99,999.999999
14,006+N×10,000 (N=0 to 7)	Calibration parameter F	calibParamF_0 to calibParamF_7	Set/Get	-99,999.999999 to 99,999.999999
14,007+N×10,000 (N=0 to 7)	X magnification	scaleX_0 to scaleX_7	Get only	-
14,008+N×10,000 (N=0 to 7)	Y magnification	scaleY_0 to scaleY_7	Get only	-
14,009+N×10,000 (N=0 to 7)	Origin X	centerX_0 to centerX_7	Get only	-
14,010+N×10,000 (N=0 to 7)	Origin Y	centerY_0 to centerY_7	Get only	-
14,011+N×10,000 (N=0 to 7)	X-axis angle	angleX_0 to angleX_7	Get only	-

No.	Data name	Data ident	Set/Get	Data range
14,012+N×10,000 (N=0 to 7)	Y-axis angle	angleY_0 to angleY_7	Get only	-
14,013+N×10,000 (N=0 to 7)	XY-axis angle	angleXY_0 to angleXY_7	Get only	-
14,016+N×10,000 (N=0 to 7)	Error evaluation	errorCenter_0 to errorCenter_7	Get only	-
14,017+N×10,000 (N=0 to 7)	X max error	maxDeflectionX_0 to maxDeflectionX_7	Get only	-
14,018+N×10,000 (N=0 to 7)	Y max error	maxDeflectionY_0 to maxDeflectionY_7	Get only	-
14,019+N×10,000 (N=0 to 7)	Sampling number of X max error	maxDeflectionNumX_0 to maxDeflectionNumX_7	Get only	0 to 204
14,020+N×10,000 (N=0 to 7)	Sampling number of Y max error	maxDeflectionNumY_0 to maxDeflectionNumY_7	Get only	0 to 204

4-27 PLC Master Calibration

This processing item is not available in the FHV series.

This processing item is specialized for calibration between the camera coordinate system and the control equipment coordinate system.

Moreover, the axis movement amount of the control equipment required for calibration can be freely set in this processing item.

If the movement method for the calibration mark is fixed and cannot be changed, use this processing item. If it can be changed, using *Vision Master Calibration* is recommended.

Used in the Following Case

When positioning the FPD panel:

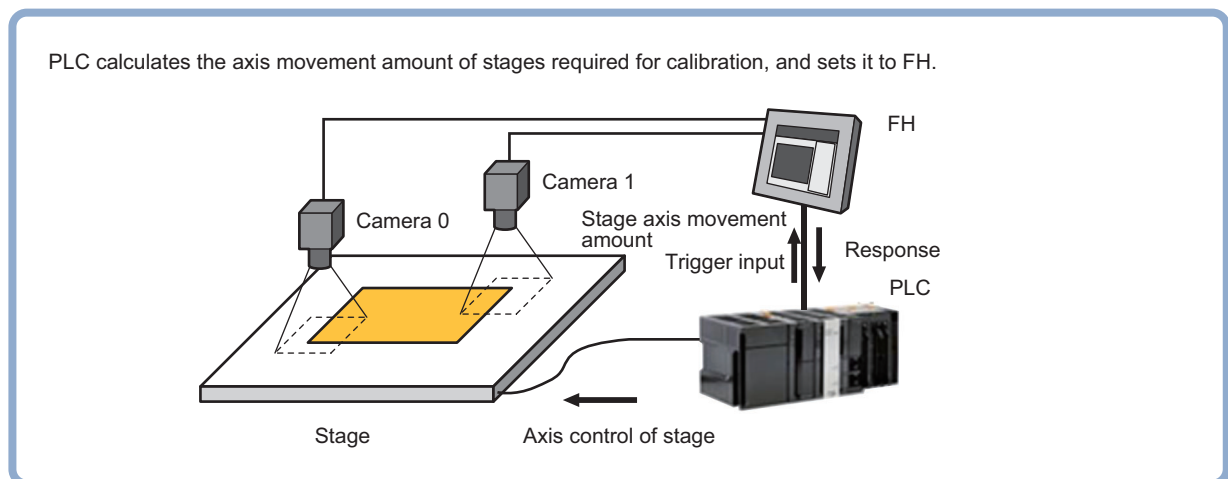

Precautions for Correct Use

- The calibration data created with this processing item is referenced with *Calibration Data Reference*. Unlike other calibration-related processing items, note that this processing item itself cannot use the calibration data.
- This item refers to processing items such as *Stage Data* or *Robot Data* which hold external equipment information required for calculating the axis movement amount. When the information is changed, the contents in this item is also changed. In that case, re-check the settings for this item.
- In the measurement flow, if the processing unit that generates the calibration data is set after the processing unit that corrects the image, the output coordinates that can be acquired by the processing unit after the processing unit that generates the calibration data are only the coordinates after image correction.

4-27-1 Settings Flow (PLC Master Calibration)

To set PLC Master Calibration, follow the steps below.

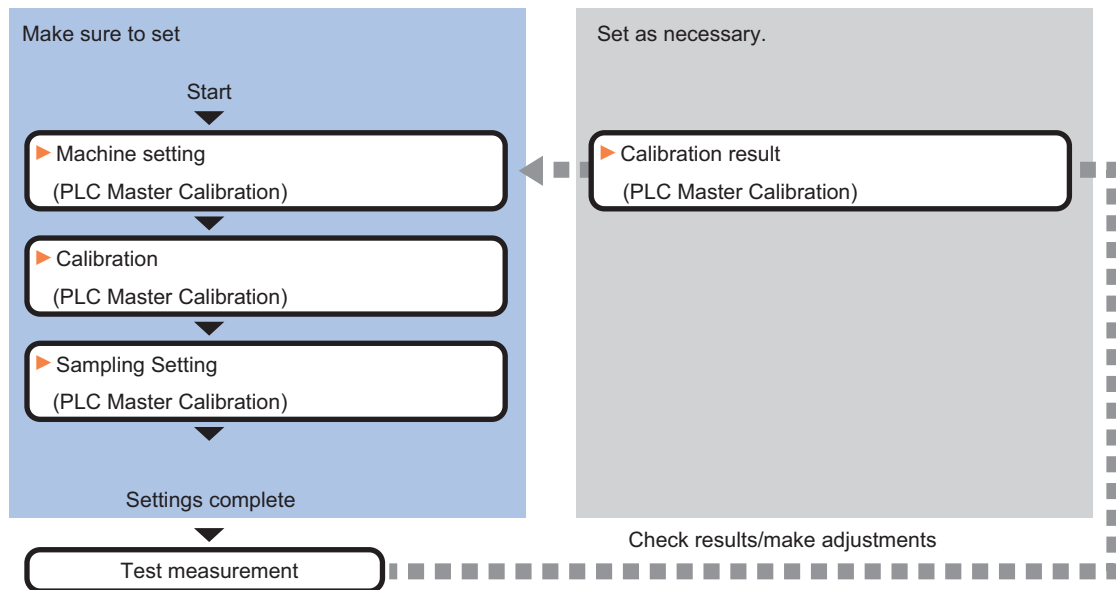

List of PLC Master Calibration Items

Item	Description
Machine setting	Selects a processing item such as <i>Stage Data</i> or <i>Robot Data</i> under which external device information needed for calculation travel distance of the actuator is held. <i>4-27-2 Machine Setting (PLC Master Calibration)</i> on page 4-177
Calibration	Sets data related to calibration. Sets the number of calibration data to be created and the measurement processing items used for sampling. Here also sets an output method for the calculated axis movement amount. <i>4-27-3 Calibration (PLC Master Calibration)</i> on page 4-178
Sampling setting	Sets data related to sampling. Also perform sampling settings for the initial calibration and this calibration respectively. <i>4-27-4 Sampling Setting (PLC Master Calibration)</i> on page 4-180
Calibration result	Check the calibration data created. To fine-tune the calibration data directly, use <i>Edit</i> function. <i>4-27-5 Calibration Result (PLC Master Calibration)</i> on page 4-181

4-27-2 Machine Setting (PLC Master Calibration)

Select a processing item such as *Stage Data* or *Robot Data* under which external device information needed for calculation of axis movement amount of the actuator is held.



Precautions for Correct Use

This item refers to *Stage Data* or *Robot Data*. Be sure to register *Stage Data* or *Robot Data* with a given scene.

- 1 In the Item tab area, click **Machine setting**.

- 2** Select a processing unit holding the external device information. Information of the selected processing unit is displayed in the *Reference data* area. Displayed contents vary depending on the type of stage or robot selected in *Stage Data* or *Robot Data* processing items.

Machine setting data

Scene No. : Present scene

Unit No. : 4.Stage data

Reference data

Stage type : XY stage

Setting item	Setting value [Factory default]	Description
Reference scene No.	[Present scene] Scene 0 to 127	Selects the scene number including a processing item such as Stage Data or <i>Robot Data</i> under which the external device information needed for calculating the axis movement amount of the actuator is held.
Reference No.	-	From among the referenced scene numbers, selects a processing item such as Stage Data or <i>Robot Data</i> under which the external device information needed for calculating the axis movement amount of the actuator is held.
Reference data	-	Displays the settings of Stage Data or <i>Robot Data</i> processing item.



Additional Information

When the number of scenes is increased with the scene group conversion tool, the upper limit value that is selectable in *Reference scene No.* is changed.

4-27-3 Calibration (PLC Master Calibration)

Set data related to calibration. Set the number of calibration data to be created and the measurement processing items used for sampling. Here also set an output method for the calculated axis movement amount.

- 1** In the Item tab area, click **Calibration settings**.
- 2** Select the calibration method in the *Calibration type* area.

Calibration type

Normal Easy

Setting item	Setting value [Factory default]	Description
Calibration type	<ul style="list-style-type: none"> [Normal] Easy 	<ul style="list-style-type: none"> Normal: Performs calibration by combining the measurement command and <i>Set Unit Data</i> command from the control equipment (PLC). Easy: Performs calibration by using the measurement command only. The movement amount can be easily set in the <i>Machine movement setting</i> area. No program control on the PLC is required.

3 Place a check at the calibration data items to set.
The calibration data checked in the No. will be created.

No.	Position X	Position Y	Judge expression	Judge lower limit	Judge upper limit
<input checked="" type="checkbox"/> 0.			TJG	1.0000	1.0000
<input type="checkbox"/> 1.			TJG	1.0000	1.0000
<input type="checkbox"/> 2.			TJG	1.0000	1.0000
<input type="checkbox"/> 3.			TJG	1.0000	1.0000
<input type="checkbox"/> 4.			TJG	1.0000	1.0000
<input type="checkbox"/> 5.			TJG	1.0000	1.0000
<input type="checkbox"/> 6.			TJG	1.0000	1.0000
<input type="checkbox"/> 7.			TJG	1.0000	1.0000

No. Position X: Position Y: Judge expression: Judge condition:

0. [] [] TJG [] 1.0000 [] - [] 1.0000 []

4 Select the row of the calibration data to set.

No.	Position X	Position Y	Judge expression	Judge lower limit	Judge upper limit
<input checked="" type="checkbox"/> 0.			TJG	1.0000	1.0000
<input type="checkbox"/> 1.			TJG	1.0000	1.0000
<input type="checkbox"/> 2.			TJG	1.0000	1.0000
<input type="checkbox"/> 3.			TJG	1.0000	1.0000
<input type="checkbox"/> 4.			TJG	1.0000	1.0000
<input type="checkbox"/> 5.			TJG	1.0000	1.0000
<input type="checkbox"/> 6.			TJG	1.0000	1.0000
<input type="checkbox"/> 7.			TJG	1.0000	1.0000

No. Position X: Position Y: Judge expression: Judge condition:

0. [] [] TJG [] 1.0000 [] - [] 1.0000 []

5 Set each item in the *Calibration target* area.

Setting item	Setting value [Factory default]	Description
Position X	-	Sets the expression to acquire camera coordinate X used for sampling.
Position Y	-	Sets the expression to acquire camera coordinate Y used for sampling.
Judge expression	[TJG]	Sets the expression to determine whether or not sampling was successful. If calibration fails with the initial value TJG, set the unit judgment JG for the processing unit referencing X and Y positions.

Setting item	Setting value [Factory default]	Description
Judge condition	-999,999,999.99 99 to 999,999,999.999 9 [1.0000] to [1.0000]	Sets the upper and lower limits to determine whether or not sampling was successful. When TJG or JG is set to the judgment expression, use the initial value as is.

4-27-4 Sampling Setting (PLC Master Calibration)

This item sets data related to sampling.

Set the number of samplings and the actual coordinate positions for each sampling. Displayed contents vary depending on the type of robot or stage selected in *Robot Data* or *Stage Data*.

- 1** In the Item tab area, click **Sampling setting**.
- 2** In the *Measurement number* area, set each item.

Setting item	Setting value [Factory default]	Description
The number of translation	2 to 100 [2]	Sets the number of samplings performed by moving the calibration workpiece in parallel.
The number of rotational motion	2 to 100 [2]	Sets the number of samplings performed by rotationally moving the calibration workpiece.

- 3** Set the value for parallel or rotational movement in the *Machine movement setting* area. Select the item you want to set in the list and set the movement amount from the reference position.

Machine movement setting

No.	Data type	X-direction move...	Y-direction move...	TH-direction mov...
0	Standard position	0.0000	0.0000	0.0000
1.	Translation position1	0.0000	0.0000	0.0000
2.	Translation position2	0.0000	0.0000	0.0000
3.	Rotation position1	0.0000	0.0000	0.0000
4	Rotation position2	0.0000	0.0000	0.0000

No. 0. X-direction movement : 0.0000 Y-direction movement : 0.0000 TH-direction movement : 0.0000

Setting item	Setting value [Factory default]	Description
X-direction movement	-99,999.9999 to 99,999.9999 [0.0000]	Sets the X-axis movement amount from the reference position.
Y-direction movement	-99,999.9999 to 99,999.9999 [0.0000]	Sets the Y-axis movement amount from the reference position.
θ-direction movement	-180.0000 to 180.0000 [0.0000]	Sets the θ-axis movement amount from the reference position.



Additional Information

When you select X, Y, Xθ, Yθ, θX, or θY stage, non-existent axis will be grayed out and you cannot set it. Only existing axes can be set.

4-27-5 Calibration Result (PLC Master Calibration)

Check the calibration data created. To fine-tune the calibration data directly, use *Edit* function. It is also possible to confirm the sampling data used for the calibration.

- 1** In the Item tab area, click **Calibration result**.
- 2** Check the calibration data generated.

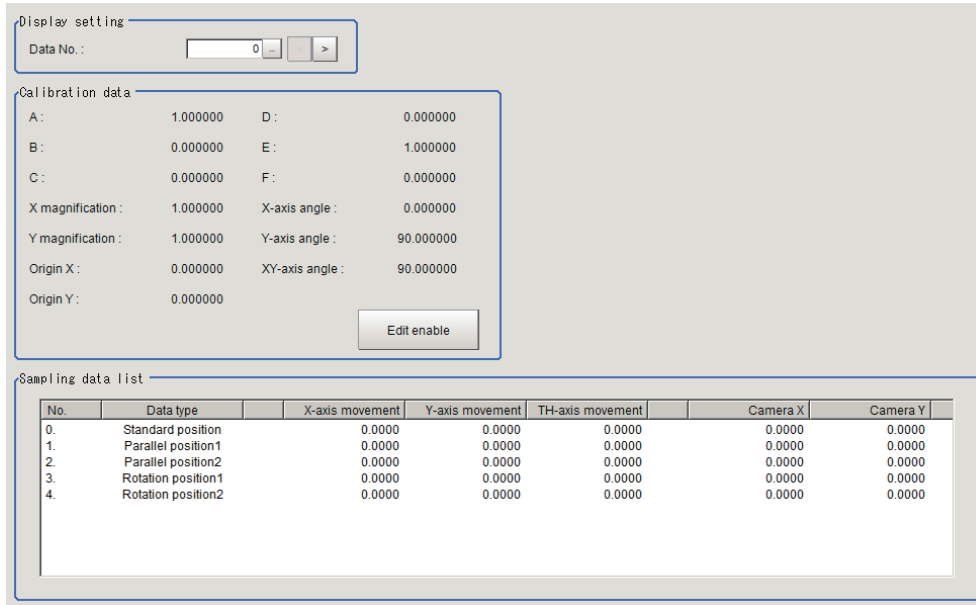

Setting item	Setting value [Factory default]	Description
Data No.	0 to 7 [0]	Sets the calibration data number displaying the calculation results.

Item	Description
Calibration data	Displays details about the calibration parameters. Click Edit enable will let you change the number for A to F. When any number has been changed, a message of <i>This data has been edited.</i> appears at the left of Edit enable .
Sampling data list	Displays sampling data used for generating the calibration parameters. When X θ , Y θ , θ X, θ Y, X, or Y stage is selected, the value for non-existing axis direction is always 0.

4-27-6 Key Points for Test Measurement and Adjustment (PLC Master Calibration)

The following content is displayed in the *Detail result* area as text.

Displayed item	Description
Judge	Judgment results 0: No judgment (unmeasured) 1: Judgment result OK -1: Judgment result NG -10: Error (image format mismatch) -11: Error (unregistered model) -12: Error (insufficient memory) -20: Error (other errors)
Calibration method	Calibration method

The image specified in the Sub-image number in the image display setting is displayed in the *Image Display* area.

Sub-image number	Description of image to be displayed
0	Measurement image + calibration progress status
1	Measurement image only

Key Points for Adjustment (PLC Master Calibration)

Adjust the setting parameters referring to the following points.

● While executing calibration

Parameter to be adjusted	Remedy
Refer to "Remedy"	<p>When unit judgement NG occurred during calibration, confirm the <i>NG cause</i> appears in the detail result pane and perform appropriate countermeasures.</p> <ul style="list-style-type: none"> • Setting NG The processing item setting is not correct. Check if the settings are correct including the processing items being referred to. • Sequence NG Measurement is executed regardless of whether calibration has been completed. Do not execute the measurement with the Next Calibration type is selected 3 (Calibration is completed) in the external reference table. • Calibration NG Calibration data calculation has failed. Check if the camera coordinates in the sampling data list in the Calculation Result Confirmation Tab are set correctly. If any data is set incorrectly, the processing items used in measurement may not be set properly. Check that the settings are correct. • Sampling NG The sampling measurement has failed. Adjust the setting data so that the processing items used in the measurement is not NG. If it still continues to occur, the judgement formula and condition may not be set correctly. Check that the settings are correct.
Calculation result confirmation	Execute the clear measurement result or external reference data #5009 <i>Clear step counter</i> .

● Others

Parameter to be adjusted	Remedy
Machine setting	<p>When the reference unit number is <None> and cannot be selected, check if the reference scene number is selected correctly. Check if stage data processing items or robot data processing items are registered in the selected reference scene.</p> <p>The reference unit number does not change during flow editing, which is the specifications. While a scene other than the current scene is referenced, the reference unit number does not change according to the editing of the flow. Change the flow so that the current scene will be referenced, or set the reference unit number again.</p>

4-27-7 Measurement Results for Which Output Is Possible (PLC Master Calibration)

The following values can be output using processing items related to result output. It is also possible to reference measurement values from calculation expressions and other processing units.

Measurement items	Character string	Description
Judge	JG	Judgment results 0: No judgment (unmeasured) 1: Judgment result OK -1: Judgment result NG -10: Error (image format mismatch) -11: Error (unregistered model) -12: Error (insufficient memory) -20: Error (other errors)
NG cause	CNG	NG cause -1: Setting NG -2: Sequence NG -3: Mobility NG -4: Calibration NG -5: Evaluation NG -6: Sampling NG -100: Other NG

4-27-8 External Reference Tables (PLC Master Calibration)

No.	Data name	Data ident	Set/Get	Data range
0	Judge	judge	Get only	0: No judgment (unmeasured), 1: Judgment result OK, -1: Judgment result NG
18	Next Calibration Operation	calibStepKind	Get only	-
19	Calibration step No.	calibStepNo	Get only	-
20	NG cause	errorCode	Get only	-
120	Calibration target flag	exeCalibrationFlag	Set/Get	0: Not process, 1: Process
121	The number of translations :	paraDataNum	Set/Get	2 to 100
122	The number of rotational motion	rotDataNum	Set/Get	2 to 100
123	Scene No.	sceneNo	Set/Get	-1: Current scene referred 0 to 9,999: Pointed scene referred
124	Unit No.	unitNo	Set/Get	-1: No reference 0 to 9,999: Pointed unit referred
125	Calibration type	calibrationType	Set/Get	0: Normal, 1: Easy
200+N×10 (N=0 to 7)	Calibration target flag of data	exeFlag0 to exeFlag7	Set/Get	0: No, 1: Yes
201+N×10 (N=0 to 7)	Position X of data	expCameraX0 to expCameraX7	Set/Get	Exp. character string
202+N×10 (N=0 to 7)	Position Y of data	expCameraY0 to expCameraY7	Set/Get	Exp. character string

No.	Data name	Data ident	Set/Get	Data range
203+N×10 (N=0 to 7)	Judge expression of data	expJudgeSampling0 to expJudgeSampling7	Set/Get	Exp. character string
204+N×10 (N=0 to 7)	Upper limit of judge condition of data	upperJudgeSampling0 to upperJudgeSampling7	Set/Get	-999,999,999.9999 to 999,999,999.9999
205+N×10 (N=0 to 7)	Lower limit of judge condition of data	lowerJudgeSampling0 to lowerJudgeSampling7	Set/Get	-999,999,999.9999 to 999,999,999.9999
1,000+N×10 (N=0 to 99)	X-direction movement of parallel position No.	paraDistanceX00 to paraDistanceX99	Set/Get	-99,999.9999 to 99,999.9999
1,001+N×10 (N=0 to 99)	Y-direction movement of parallel position No.	paraDistanceY00 to paraDistanceY99	Set/Get	-99,999.9999 to 99,999.9999
2,000+N×10 (N=0 to 99)	X-direction movement of rotation position No.	rotDistanceX00 to rotDistanceX99	Set/Get	-99,999.9999 to 99,999.9999
2,001+N×10 (N=0 to 99)	Y-direction movement of rotation position No.	rotDistanceY00 to rotDistanceY99	Set/Get	-99,999.9999 to 99,999.9999
2,002+N×10 (N=0 to 99)	TH-direction movement of rotation position No.	rotTheta00 to rotTheta99	Set/Get	-180 to 180
5,000	Calibration start/end	startCalibration	Set only	0: Calibration end 1: Calibration start
5,001	Set calibration target	setCalibrationTarget	Set only	0 to 255
5,002	Set standard position	setStandardPosition	Set only	1: Execute
5,003	Set parallel position	setParallelPosition	Set only	1 to 100
5,004	Set rotation position	setRotationPosition	Set only	1 to 100
5,005	Calculate calibration data	calcCalibrationData	Set only	1: Execute
5,006	Calculate deflection data	calcDeflectionData	Set only	1: Execute
5,007	Clear sampling data	clearSamplingData	Set only	1: Execute
5,009	Clear step counter	clearStepCounter	Set only	1: Execute
14,000+N×10,000 (N=0 to 7)	Deflection of data	deflection_0 to deflection_7	Get only	-
14,001+N×10,000 (N=0 to 7)	Calibration parameter A of data	calibParamA_0 to calibParamA_7	Set/Get	-99,999.999999 to 99,999.999999
14,002+N×10,000 (N=0 to 7)	Calibration parameter B of data	calibParamB_0 to calibParamB_7	Set/Get	-99,999.999999 to 99,999.999999
14,003+N×10,000 (N=0 to 7)	Calibration parameter C of data	calibParamC_0 to calibParamC_7	Set/Get	-99,999.999999 to 99,999.999999
14,004+N×10,000 (N=0 to 7)	Calibration parameter D of data	calibParamD_0 to calibParamD_7	Set/Get	-99,999.999999 to 99,999.999999

No.	Data name	Data ident	Set/Get	Data range
14,005+N×10,000 (N=0 to 7)	Calibration parameter E of data	calibParamE_0 to calibParamE_7	Set/Get	-99,999.999999 to 99,999.999999
14,006+N×10,000 (N=0 to 7)	Calibration parameter F of data	calibParamF_0 to calibParamF_7	Set/Get	-99,999.999999 to 99,999.999999
14,007+N×10,000 (N=0 to 7)	X magnification of data	scaleX_0 to scaleX_7	Get only	-
14,008+N×10,000 (N=0 to 7)	Y magnification of data	scaleY_0 to scaleY_7	Get only	-
14,009+N×10,000 (N=0 to 7)	Origin X of data	centerX_0 to centerX_7	Get only	-
14,010+N×10,000 (N=0 to 7)	Origin Y of data	centerY_0 to centerY_7	Get only	-
14,011+N×10,000 (N=0 to 7)	X-axis angle of data	angleX_0 to angleX_7	Get only	-
14,012+N×10,000 (N=0 to 7)	Y-axis angle of data	angleY_0 to angleY_7	Get only	-
14,013+N×10,000 (N=0 to 7)	XY-axis angle of data	angleXY_0 to angleXY_7	Get only	-

4-28 Transfer Position Data

This processing item calculates the movement post-position and angle data after when each axis of a stage or robot is moved for an arbitrary amount. Use this item when you want to get the pre-position and angle data by measuring after moving the stage by an arbitrary amount.

Used in the Following Case

When positioning the FPD panel:

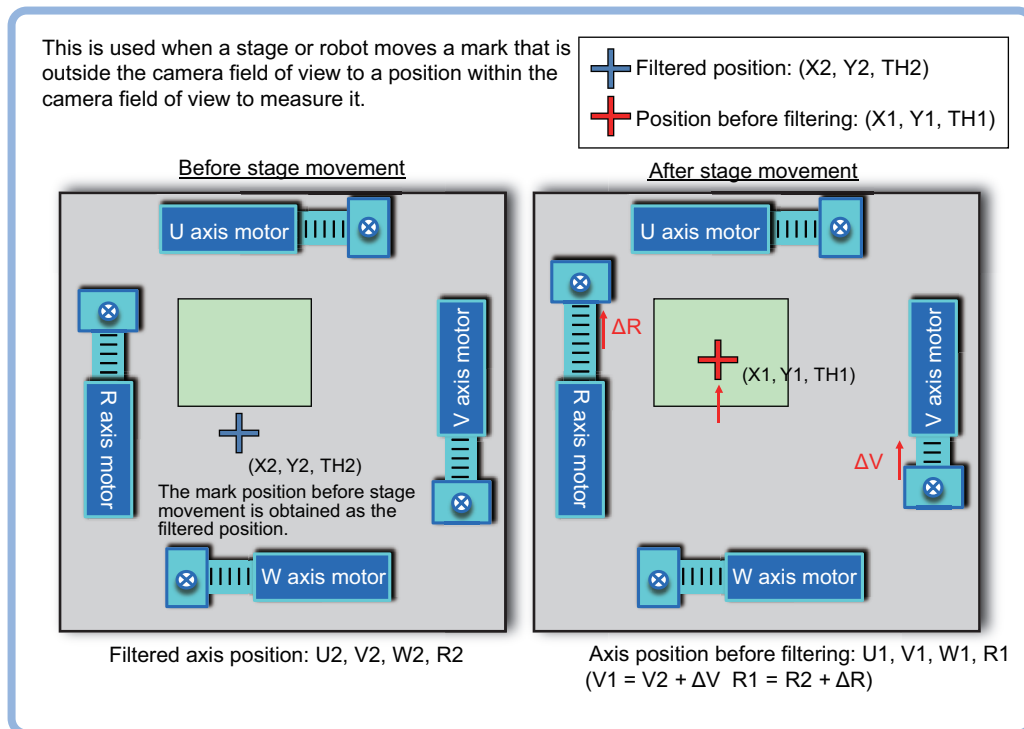

4-28-1 Settings Flow (Transfer Position Data)

To set Transfer Position Data, follow the steps below.

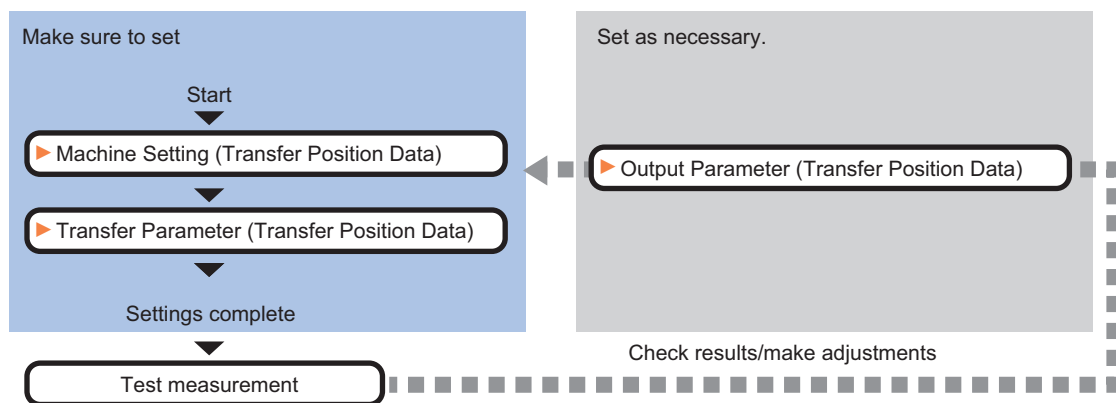

List of Transfer Position Data Items

Item	Description
Machine setting	Selects a processing item such as <i>Stage Data</i> or <i>Robot Data</i> under which external device information needed for calculation travel distance of the actuator is held. <i>4-28-2 Machine Setting (Transfer Position Data)</i> on page 4-188
Transfer parameter	Sets data related to conversion. Here sets a calculation formula using the pre-conversion position and axis position and post-conversion axis position. <i>4-28-3 Transfer Parameter (Transfer Position Data)</i> on page 4-189
Output parameter	Selects whether or not to reflect the judgment result to the overall judgment of the scene. <i>4-28-4 Output parameter (Transfer Position Data)</i> on page 4-194

4-28-2 Machine Setting (Transfer Position Data)

Select a processing item such as *Stage Data* or *Robot Data* under which external device information needed for calculation of axis movement amount of the actuator is held.



Precautions for Correct Use

This item refers to *Stage Data* or *Robot Data*. Be sure to register *Stage Data* or *Robot Data* with a given scene.

- 1 In the Item tab area, click **Machine setting**.
- 2 Select a processing unit holding the external device information.
Information of the selected processing unit is displayed in the *Reference data* area.
Displayed contents vary depending on the type of stage or robot selected in *Stage Data* or *Robot Data* processing items.

Machine setting data

Reference scene No. : Present scene

Reference unit No. : 2 Stage data

Reference data

Stage type : XY stage

Setting item	Setting value [Factory default]	Description
Reference scene No.	[Present scene] Scene 0 to 127	Selects the scene number including a processing item such as <i>Stage Data</i> or <i>Robot Data</i> under which the external device information needed for calculating the axis movement amount of the actuator is held.
Reference No.	-	From among the referenced scene numbers, selects a processing item such as <i>Stage Data</i> or <i>Robot Data</i> under which the external device information needed for calculating the axis movement amount of the actuator is held.
Reference data	-	Displays the settings of <i>Stage Data</i> or <i>Robot Data</i> processing item.



Additional Information

When the number of scenes is increased with the scene group conversion tool, the upper limit value that is selectable in *Reference scene No.* is changed.

4-28-3 Transfer Parameter (Transfer Position Data)

The item sets data related to conversion.

Set a calculation formula using the pre-conversion position and axis position and post-conversion axis position.

- 1 In the Item Tab area, click **Transfer parameter**.
- 2 In the *Current point position* area, set each item.

Setting item	Setting value [Factory default]	Description
Position X	-	Sets the calculation expression that obtains the position X of the conversion target.
Position Y	-	Sets the calculation expression that obtains the position Y of the conversion target.
position angle	-	Sets the calculation expression that obtains the angle of the conversion target. To convert positions X and Y only, set 0 as the angle.

- 3 Set each item in the *Current axis position* area before conversion.
Here sets how far each axis moved from the origin return state (all axes are at the origin point) at the time of *Current angle* measured.
 - When the type of stage of the reference data is the XY stage or the type of robot is a three-axis robot.

Setting item	Setting value [Factory default]	Description
X-axis	-	Sets how far the X-axis position moved from the origin.
Y-axis	-	Sets how far the Y-axis position moved from the origin.

- When the type of stage for the reference data is the XYθ stage, θXY stage, or the type of robot is a four-axis robot.

Current axis position

X-axis :

Y-axis :

θ-axis :

Setting item	Setting value [Factory default]	Description
X-axis	-	Sets how far the X-axis position moved from the origin.
Y-axis	-	Sets how far the Y-axis position moved from the origin.
θ-axis	-	Set how fa the θ-axis position moved from the origin.

- When the type of stage for the reference data is the UVW stage.

Current axis position

U-axis :

V-axis :

W-axis :

Setting item	Setting value [Factory default]	Description
U-axis	-	Sets how far the U-axis position moved from the origin.
V-axis	-	Sets how far the V-axis position moved from the origin.
W-axis	-	Sets how far the W-axis position moved from the origin.

- When the type of stage for the reference data is the UVWR stage.

Current axis position

U-axis :

V-axis :

W-axis :

R-axis :

Setting item	Setting value [Factory default]	Description
U-axis	-	Sets how far the U-axis position moved from the origin.
V-axis	-	Sets how far the V-axis position moved from the origin.
W-axis	-	Sets how far the W-axis position moved from the origin.
R-axis	-	Sets how far the R-axis position moved from the origin.

- When X-axis is selected as the movement axis and the type of the reference data is X(Y) stage.

Current axis position

X-axis :

Setting item	Setting value [Factory default]	Description
X-axis	-	Sets how far the X-axis position moved from the origin.

- When Y-axis is selected as the movement axis and the type of the reference data is X(Y) stage.

Current axis position

Y-axis: -

Setting item	Setting value [Factory default]	Description
Y-axis	-	Sets how far the Y-axis position moved from the origin.

- When X-axis is selected as the movement axis and the type of stage is Xθ(Yθ) stage or θX(θY) stage.

Current axis position

X-axis: -

θ-axis: -

Setting item	Setting value [Factory default]	Description
X-axis	-	Sets how far the X-axis position moved from the origin.
θ-axis	-	Set how fa the θ-axis position moved from the origin.

- When Y-axis is selected as the movement axis and the type of stage is Xθ(Yθ) stage or θX(θY) stage.

Current axis position

Y-axis: -

θ-axis: -

Setting item	Setting value [Factory default]	Description
Y-axis	-	Sets how far the Y-axis position moved from the origin.
θ-axis	-	Set how fa the θ-axis position moved from the origin.

4 Set each item in the *Transferred axis position* area.

Here sets how far each axis in the *Post-correction position and angle* moved from the origin retune state (all axes are at the origin point).

- When the type of stage for the reference data is the XY stage or a three-axis robot.

Transferred axis position

X-axis: -

Y-axis: -

Setting item	Setting value [Factory default]	Description
X-axis	-	Sets how far the X-axis position moved from the origin.
Y-axis	-	Sets how far the Y-axis position moved from the origin.

- When the type of stage for the reference data is XYθ stage or a four-axis robot.

Transferred axis position

X-axis :

Y-axis :

θ-axis :

Setting item	Setting value [Factory default]	Description
X-axis	-	Sets how far the X-axis position moved from the origin.
Y-axis	-	Sets how far the Y-axis position moved from the origin.
θ-axis	-	Set how fa the θ-axis position moved from the origin.

- When the type of stage for the reference data is the UVW stage.

Transferred axis position

U-axis :

V-axis :

W-axis :

Setting item	Setting value [Factory default]	Description
U-axis	-	Sets how far the U-axis position moved from the origin.
V-axis	-	Sets how far the V-axis position moved from the origin.
W-axis	-	Sets how far the W-axis position moved from the origin.

- When the type of stage for the reference data is the UVWR stage.

Transferred axis position

U-axis :

V-axis :

W-axis :

R-axis :

Setting item	Setting value [Factory default]	Description
U-axis	-	Sets how far the U-axis position moved from the origin.
V-axis	-	Sets how far the V-axis position moved from the origin.
W-axis	-	Sets how far the W-axis position moved from the origin.
R-axis	-	Sets how far the R-axis position moved from the origin.

- When X-axis is selected as the movement axis and the type of stage for the reference data is the X(Y) stage.

変換後の軸位置

X軸 :

Setting item	Setting value [Factory default]	Description
X-axis	-	Sets how far the X-axis position moved from the origin.

- When Y-axis is selected as the movement axis and the type of stage for the reference data is the X(Y) stage.

Setting item	Setting value [Factory default]	Description
Y-axis	-	Sets how far the Y-axis position moved from the origin.

- When X-axis is selected as the movement axis and the type of stage for the reference data is the Xθ(Yθ) stage or θX(θY) stage.

Setting item	Setting value [Factory default]	Description
X-axis	-	Sets how far the X-axis position moved from the origin.
θ-axis	-	Set how fa the θ-axis position moved from the origin.

- When Y-axis is selected as the movement axis and the type of stage for the reference data is the Xθ(Yθ) stage or θX(θY) stage.

Setting item	Setting value [Factory default]	Description
Y-axis	-	Sets how far the Y-axis position moved from the origin.
θ-axis	-	Set how fa the θ-axis position moved from the origin.

5 Click **Measure** to check the measurement results.

6 Set the judgment condition.



Additional Information

The values displayed beside each item are measurement results for the displayed image. Determine the upper and lower limit values by referencing these values.

Setting item	Setting value	Description
Transferred position X	-99,999.9999 to 99,999.9999	Specifies the range of X-axis conversion to be judged as OK.
Transferred position Y	-99,999.9999 to 99,999.9999	Specifies the range of Y-axis conversion to be judged as OK.
Transferred angle	-180.0000 to 180.0000	Specifies the range of angle conversion to be judged as OK.

4-28-4 Output parameter (Transfer Position Data)

Select whether or not to reflect the judgment results of this processing unit to the overall judgment of the scene.

- 1 In the Item tab area, click **Output parameter**.
- 2 Select whether or not to reflect it to the overall judgment in *Reflect to overall judgement* area.

Setting item	Setting value [Factory default]	Description
Reflect to overall judgment	<ul style="list-style-type: none"> • [ON] • OFF 	Enables choosing whether or not the judgement results of this processing unit is reflected in the scene overall judgment.

4-28-5 Key Points for Test Measurement and Adjustment (Transfer Position Data)

The following content is displayed in the *Detail result* area as text.

Displayed item	Description
Judge	Judgment results 0: No judgment (unmeasured) 1: Judgment result OK -1: Judgment result NG -10: Error (image format mismatch) -11: Error (unregistered model) -12: Error (insufficient memory) -20: Error (other errors)
Transferred position X	Displays the position X of the post-conversion measurement data.
Transferred position Y	Displays the position Y of the post-conversion measurement data.
Transferred angle	Displays the angle of the post-conversion measurement data.

The image specified in the Sub-image number in the image display setting is displayed in the *Image Display* area.

Sub-image number	Description of image to be displayed
0	Measurement image

Key Points for Adjustment

When the judgement is NG

Parameter to be adjusted	Remedy
Calculation setting	The arithmetic expression may be empty. Set the correct arithmetic expression.

Others

Parameter to be adjusted	Remedy
Machine setting	<p>When the reference unit number is <None> and cannot be selected, check if the reference scene number is selected correctly.</p> <p>Check if stage data processing items or robot data processing items are registered in the selected reference scene.</p>
	<p>The reference unit number does not change during flow editing, which is the specifications.</p> <p>While a scene other than the current scene is referenced, the reference unit number does not change according to the editing of the flow. Change the flow so that the current scene will be referenced, or set the reference unit number again.</p>

4-28-6 Measurement Results for Which Output Is Possible (Transfer Position Data)

The following values can be output using processing items related to result output. It is also possible to reference measurement values from calculation expressions and other processing units.

Measurement items	Character string	Description
Judge	JG	<p>Judgment results</p> <p>0: No judgment (unmeasured)</p> <p>1: Judgment result OK</p> <p>-1: Judgment result NG</p> <p>-10: Error (image format mismatch)</p> <p>-11: Error (unregistered model)</p> <p>-12: Error (insufficient memory)</p> <p>-20: Error (other errors)</p>
Transferred position X	X	Transferred position X
Transferred position Y	Y	Transferred position Y
Transferred angle	TH	Transferred angle

4-28-7 External Reference Tables (Transfer Position Data)

No.	Data name	Data ident	Set/Get	Data range
0	Judge	judge	Get only	0: No judgment (unmeasured), 1: Judgment result OK, -1: Judgment result NG, -10: Error (image format mismatch), -11: Error (unregistered model), -12: Error (insufficient memory), -20: Error (other errors)
5	Transferred position X	destPositionX	Get only	-
6	Transferred position Y	destPositionY	Get only	-
7	Transferred angle	destAngle	Get only	-
103	Reflect to overall judgement	overallJudge	Set/Get	0: ON, 1: OFF

No.	Data name	Data ident	Set/Get	Data range
120	Reference scene No.	sceneNo	Set/Get	-1: Current scene referred 0 to 9,999: Pointed scene referred
121	Reference unit No.	unitNo	Set/Get	-1: No reference 0 to 9,999: Pointed unit referred
122	Current position X	srcPositionX	Set/Get	Exp. character string
123	Current position Y	srcPositionY	Set/Get	Exp. character string
124	Current angle	srcAngle	Set/Get	Exp. character string
130	Current X-axis	srcAxisX	Set/Get	Exp. character string
131	Current Y-axis	srcAxisY	Set/Get	Exp. character string
132	Current θ -axis(angle)	srcAxisAngle	Set/Get	Exp. character string
133	Current θ -axis(linear drive)	srcAxisTheta	Set/Get	Exp. character string
134	Current U-axis	srcAxisU	Set/Get	Exp. character string
135	Current V-axis	srcAxisV	Set/Get	Exp. character string
136	Current W-axis	srcAxisW	Set/Get	Exp. character string
137	Current R-axis	srcAxisR	Set/Get	Exp. character string
140	Transferred X-axis	destAxisX	Set/Get	Exp. character string
141	Transferred Y-axis	destAxisY	Set/Get	Exp. character string
142	Transferred θ -axis(angle)	destAxisAngle	Set/Get	Exp. character string
143	Transferred θ -axis(linear drive)	destAxisTheta	Set/Get	Exp. character string
144	Transferred U-axis	destAxisU	Set/Get	Exp. character string
145	Transferred V-axis	destAxisV	Set/Get	Exp. character string
146	Transferred W-axis	destAxisW	Set/Get	Exp. character string
147	Transferred R-axis	destAxisR	Set/Get	Exp. character string
150	Upper limit of transferred position X	upperDestPosX	Set/Get	-99,999.9999 to 99,999.9999
151	Lower limit of transferred position X	lowerDestPosX	Set/Get	-99,999.9999 to 99,999.9999
152	Upper limit of transferred position Y	upperDestPosY	Set/Get	-99,999.9999 to 99,999.9999
153	Lower limit of transferred position Y	lowerDestPosY	Set/Get	-99,999.9999 to 99,999.9999
154	Upper limit of transferred angle	upperDestAngle	Set/Get	-180 to 180
155	Lower limit of transferred angle	lowerDestAngle	Set/Get	-180 to 180
160	Current Yaw-axis	srcAxisYaw	Set/Get	Exp. character string
161	Current Pitch-axis	srcAxisPitch	Set/Get	Exp. character string
162	Current Roll-axis	srcAxisRoll	Set/Get	Exp. character string
170	Transferred Yaw-axis	destAxisYaw	Set/Get	Exp. character string
171	Transferred Pitch-axis	destAxisPitch	Set/Get	Exp. character string
172	Transferred Roll-axis	destAxisRoll	Set/Get	Exp. character string

4-29 Calc Axis Move

This processing item calculates each axis movement amount of the external equipment required for matching the measurement position and angle to the reference position and angle. Those position and angle are set with an expression.

Used in the Following Case

When positioning the FPD panel

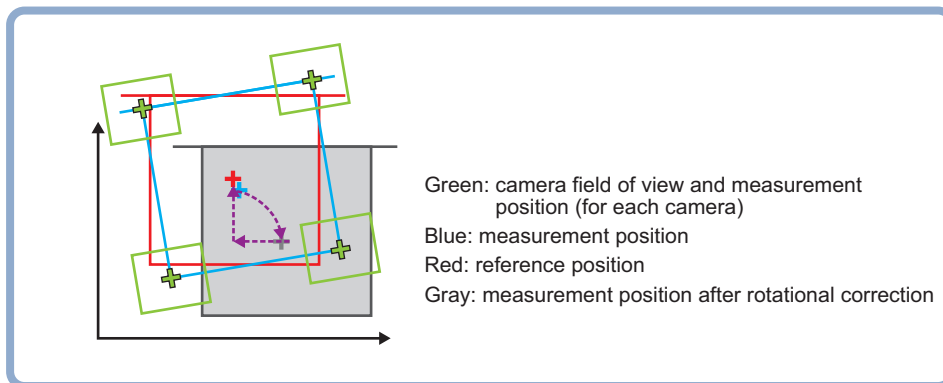

4-29-1 Settings Flow (Calc Axis Move)

To set Calc Axis Move, follow the steps below.

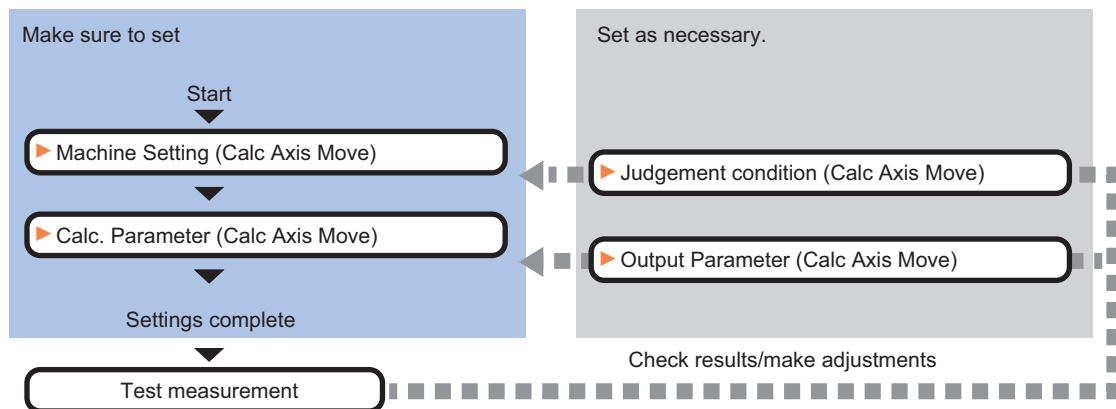

List of Calc Axis Move Items

Item	Description
Machine setting	Selects a processing item such as <i>Stage Data</i> or <i>Robot Data</i> under which external device information needed for calculation travel distance of the actuator is held. 4-29-2 <i>Machine Setting (Calc Axis Move)</i> on page 4-198
Calc parameter	Sets the reference position and angle and measurement position and angle using a calculation expression. when using multiple cameras, the setting data can be created easily by using the position and angle calculation processing items. 4-29-3 <i>Calc. Parameter (Calc Axis Move)</i> on page 4-199

Item	Description
Judgment condition	Sets processing conditions for measurement and judgment conditions for measurement results. <i>4-29-4 Judgment Condition (Calc Axis Move) on page 4-202</i>
Output parameter	This item can be changed as necessary. Selects whether or not to reflect the judgment result to the overall judgment of the scene. <i>4-29-5 Output Parameter (Calc Axis Move) on page 4-204</i>

4-29-2 Machine Setting (Calc Axis Move)

Select a processing item such as *Stage Data* or *Robot Data* under which external device information needed for calculation of axis movement amount of the actuator is held.

- 1** In the Item tab area, click **Machine setting**.
- 2** Select a processing unit holding the external device information.
The information of the selected processing unit is displayed in the *Reference data display* area.
Displayed contents vary depending on the selected type of robot or stage.

Machine setting data

Reference scene No. : Present scene

Reference unit No. : 2.Stage data

Reference data

Stage type : XY stage

Setting item	Setting value [Factory default]	Description
Reference scene No.	[Present scene] Scene 0 to 127	Selects the scene number including a processing item such as Stage Data or <i>Robot Data</i> under which the external device information needed for calculating the axis movement amount of the actuator is held.
Reference No.	-	From among the referenced scene numbers, selects a processing item such as Stage Data or <i>Robot Data</i> under which the external device information needed for calculating the axis movement amount of the actuator is held.
Reference data	-	Displays the settings of Stage Data or <i>Robot Data</i> processing item.



Additional Information

When the number of scenes is increased with the scene group conversion tool, the upper limit value that is selectable in *Reference scene No.* is changed.

4-29-3 Calc. Parameter (Calc Axis Move)

Here set the reference position and angle and measurement position and angle using a calculation expression. When using multiple cameras, the setting data can be created easily by using the *Position Data Calculation* processing items.

An offset is a parameter to set a deviation amount beforehand when there has already been a deviation between the reference position and angle and the measurement position and angle. By considering the deviation amount, calculate an axis move amount.

When two sheets of different size are pasted together like below example 1, if an offset is not set, an application calculates the movement amount as it considers one of the sheets has deviated vertically. But if the offset is set previously, the movement amount can be calculated according to the position relationships in the drawing below. Alignment using external marks can be also handled in the same way.

Ex. 1: When an offset in the vertical direction is required.

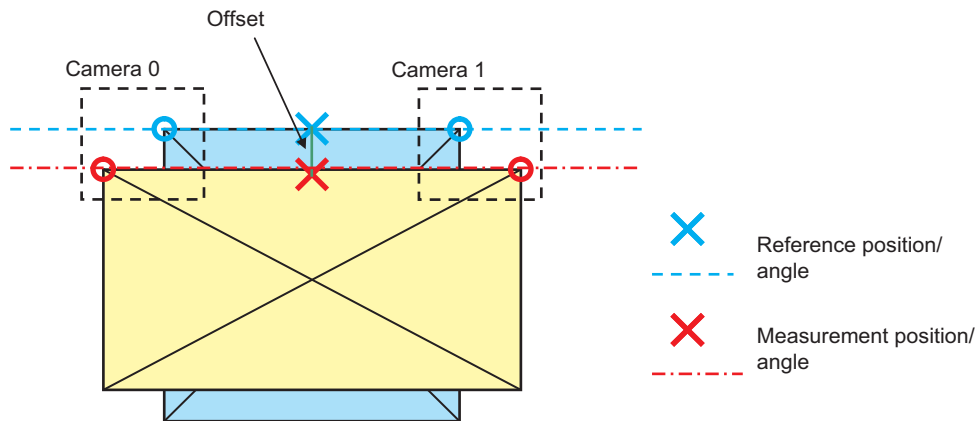

Ex. 2: When offsets in the vertical direction and angle direction are required.

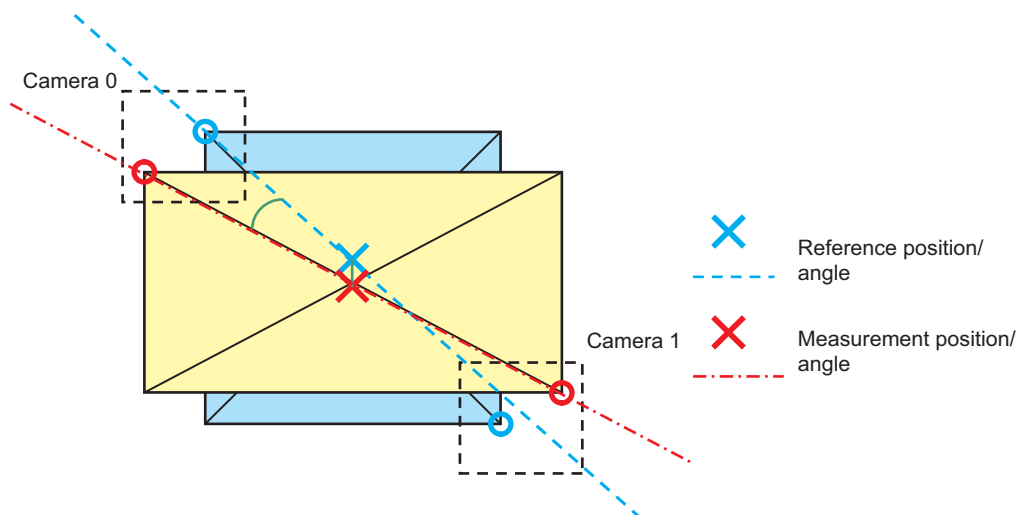

- 1 In the Item tab area, click **Calc. parameter**.
- 2 Set each parameter using expressions.
<When no reference data is selected>

The screenshot displays a software interface with five main sections, each containing input fields with dropdown arrows:

- Reference position:** Position X, Position Y, Angle.
- Reference offset:** Position X, Position Y, Angle, Initial angle.
- Measurement position:** Position X, Position Y, Angle.
- Measurement offset:** Position X, Position Y, Angle, Initial angle.
- Current axis position:** X-axis, Y-axis, θ -axis.

Displayed parameters vary depending on the type of stage selected.

Displayed content	Not selected	XY	XY θ	θ XY	UV W	UV WR	X θ (Y θ)	θ X(θ Y)	X(Y)	3 axes	4 axes
Reference position X	<input type="checkbox"/>	<input type="checkbox"/>	<input type="checkbox"/>	<input type="checkbox"/>	<input type="checkbox"/>	<input type="checkbox"/>	<input type="checkbox"/>	<input type="checkbox"/>	<input type="checkbox"/>	<input type="checkbox"/>	<input type="checkbox"/>
Reference position Y	<input type="checkbox"/>	<input type="checkbox"/>	<input type="checkbox"/>	<input type="checkbox"/>	<input type="checkbox"/>	<input type="checkbox"/>	<input type="checkbox"/>	<input type="checkbox"/>	<input type="checkbox"/>	<input type="checkbox"/>	<input type="checkbox"/>
Reference angle	<input type="checkbox"/>	-	<input type="checkbox"/>	<input type="checkbox"/>	<input type="checkbox"/>	<input type="checkbox"/>	<input type="checkbox"/>	<input type="checkbox"/>	-	-	<input type="checkbox"/>
Measurement position X	<input type="checkbox"/>	<input type="checkbox"/>	<input type="checkbox"/>	<input type="checkbox"/>	<input type="checkbox"/>	<input type="checkbox"/>	<input type="checkbox"/>	<input type="checkbox"/>	<input type="checkbox"/>	<input type="checkbox"/>	<input type="checkbox"/>
Measurement position Y	<input type="checkbox"/>	<input type="checkbox"/>	<input type="checkbox"/>	<input type="checkbox"/>	<input type="checkbox"/>	<input type="checkbox"/>	<input type="checkbox"/>	<input type="checkbox"/>	<input type="checkbox"/>	<input type="checkbox"/>	<input type="checkbox"/>
Measurement angle	<input type="checkbox"/>	-	<input type="checkbox"/>	<input type="checkbox"/>	<input type="checkbox"/>	<input type="checkbox"/>	<input type="checkbox"/>	<input type="checkbox"/>	-	-	<input type="checkbox"/>
Offset											
Reference position X	<input type="checkbox"/>	<input type="checkbox"/>	<input type="checkbox"/>	<input type="checkbox"/>	<input type="checkbox"/>	<input type="checkbox"/>	<input type="checkbox"/>	<input type="checkbox"/>	<input type="checkbox"/>	<input type="checkbox"/>	<input type="checkbox"/>
Reference position Y	<input type="checkbox"/>	<input type="checkbox"/>	<input type="checkbox"/>	<input type="checkbox"/>	<input type="checkbox"/>	<input type="checkbox"/>	<input type="checkbox"/>	<input type="checkbox"/>	<input type="checkbox"/>	<input type="checkbox"/>	<input type="checkbox"/>
Reference Angle	<input type="checkbox"/>	-	<input type="checkbox"/>	<input type="checkbox"/>	<input type="checkbox"/>	<input type="checkbox"/>	<input type="checkbox"/>	<input type="checkbox"/>	-	-	<input type="checkbox"/>
Initial angle	<input type="checkbox"/>	-	<input type="checkbox"/>	<input type="checkbox"/>	<input type="checkbox"/>	<input type="checkbox"/>	<input type="checkbox"/>	<input type="checkbox"/>	-	-	<input type="checkbox"/>
Measurement position X	<input type="checkbox"/>	<input type="checkbox"/>	<input type="checkbox"/>	<input type="checkbox"/>	<input type="checkbox"/>	<input type="checkbox"/>	<input type="checkbox"/>	<input type="checkbox"/>	<input type="checkbox"/>	<input type="checkbox"/>	<input type="checkbox"/>
Measurement position Y	<input type="checkbox"/>	<input type="checkbox"/>	<input type="checkbox"/>	<input type="checkbox"/>	<input type="checkbox"/>	<input type="checkbox"/>	<input type="checkbox"/>	<input type="checkbox"/>	<input type="checkbox"/>	<input type="checkbox"/>	<input type="checkbox"/>
Measurement angle	<input type="checkbox"/>	-	<input type="checkbox"/>	<input type="checkbox"/>	<input type="checkbox"/>	<input type="checkbox"/>	<input type="checkbox"/>	<input type="checkbox"/>	-	-	<input type="checkbox"/>

Displayed content		Not selected	XY	XY θ	θ XY	UV W	UV WR	X θ (Y θ)	θ X(θ Y)	X(Y)	3 axes	4 axes
	Measurement initial angle	○	-	○	○	○	○	○	○	-	-	○
Current axis position												
	X-axis	-	○	○	○	-	-	○ (X-axis is selected as the movement axis.)	○ (X-axis is selected as the movement axis.)	○ (X-axis is selected as the movement axis.)	○	○
	Y-axis	-	○	○	○	-	-	○ (Y-axis is selected as the movement axis.)	○ (Y-axis is selected as the movement axis.)	○ (Y-axis is selected as the movement axis.)	○	○
	θ -axis	-	-	○	○	-	-	○	○	-	-	○
	U-axis	-	-	-	-	○	○	-	-	-	-	-
	V-axis	-	-	-	-	○	○	-	-	-	-	-
	W-axis	-	-	-	-	○	○	-	-	-	-	-
	R-axis	-	-	-	-	-	○	-	-	-	-	-

○: Displayed, -: Not displayed

Initial angle

Initial angle is the angle when an offset amount is calculated.

Ex. : When positioning a chip condenser on a substrate using the angle of the diagonal line and the center position for both workpieces.

Symbol definition in the following figure

- Measurement position and angle when the offset amount is calculated (MX, MY, MT)
- Reference position and angle when the offset amount is calculated (SX, SY, ST)
- Offset amount of measurement position and angle (OMX, OMY, OMT)
- Offset amount of reference position and angle (OSX, OSY, OST)

Setting contents for *Measurement position offset setting* of the **Calc Axis Move**.

- Position X: $OMX = SX - MX$
- Position Y: $OMY = SY - MY$
- Angle: $OMT = ST - MT$
- Initial angle: MT

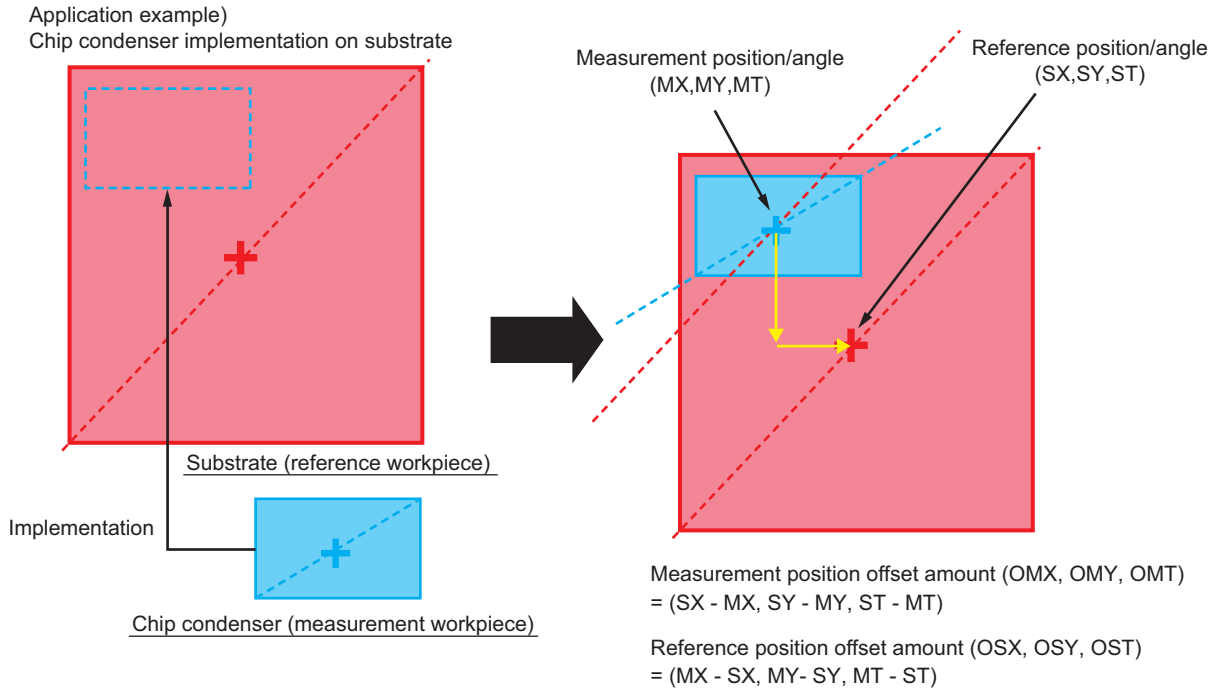

4-29-4 Judgment Condition (Calc Axis Move)

Here sets the judgment condition for measurement results.

- 1 When the setting has been changed, click **Measure** to verify whether measurement can be performed correctly.

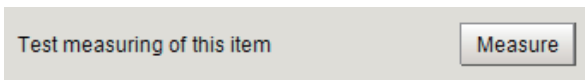

- 2 In the *Judgment condition* area, set each item.
<When the reference data is the XYθ stage.>

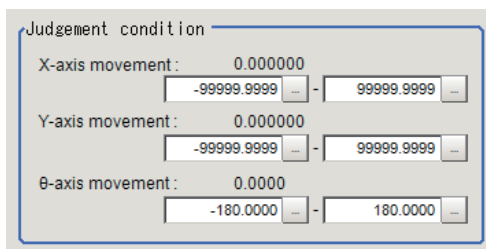

Displayed parameters vary depending on the type of stage selected.

Dis- played contents	No t se- lec- ted	XY	XYθ	θXY	UV W	UV W R	Xθ(Yθ)	θX(θY)	X(Y)	3 ax- es	4 ax- es
X-axis move- ment amount judge- ment up- per and lower lim- it values	○	○	○	○	-	-	○ (X-axis is selected as the move- ment ax- is.)	○ (X-axis is selected as the move- ment ax- is.)	○ (X-axis is selected as the move- ment ax- is.)	○	○
Y-axis move- ment amount judge- ment up- per and lower lim- it values	○	○	○	○	-	-	○ (Y-axis is selected as the move- ment ax- is.)	○ (Y-axis is selected as the move- ment ax- is.)	○ (Y-axis is selected as the move- ment ax- is.)	○	○
θ-axis move- ment amount judge- ment up- per and lower lim- it values	○	-	○ (θ-axis direct drive)	○ (θ-axis direct drive)	-	-	○ (θ-axis direct drive)	○ (θ-axis direct drive)	-	-	○
θ-axis lin- ear move- ment amount judge- ment up- per and lower lim- it values	-	-	○ (θ-axis direct drive)	○ (θ-axis direct drive)	-	-	○ (θ-axis direct drive)	○ (θ-axis direct drive)	-	-	-
U- axis move- ment amount judge- ment up- per and lower lim- it values	-	-	-	-	○	○	-	-	-	-	-

Dis- played contents	No t se- lec- ted	XY	XY θ	θ XY	UV W	UV W R	X θ (Y θ)	θ X(θ Y)	X(Y)	3 ax- es	4 ax- es
V- axis move- ment amount judge- ment up- per and lower lim- it values	-	-	-	-	○	○	-	-	-	-	-
W- axis move- ment amount judge- ment up- per and lower lim- it values	-	-	-	-	○	○	-	-	-	-	-
R- axis move- ment amount judge- ment up- per and lower lim- it values	-	-	-	-	-	○	-	-	-	-	-

○: Displayed, - : Not displayed

4-29-5 Output Parameter (Calc Axis Move)

Here sets how to handle the coordinates to be output to external devices as measurement results. This item can be changed as necessary. Normally, the factory default value will be used.

- 1** In the Item tab area, click **Output parameter**.
- 2** Set each item.

Setting item	Setting value [Factory default]	Description
Reflect to overall judgment	<ul style="list-style-type: none"> • [ON] • OFF 	Enables choosing whether or not the judgement results of this processing unit is reflected in the scene overall judgment.
Output type	<ul style="list-style-type: none"> • [Relative position] • Absolute position 	<ul style="list-style-type: none"> • Relative position: Calculates the movement amount from the current axis position. • Absolute position: Calculates the movement amount from the Homing operation position.

4-29-6 Key Points for Test Measurement and Adjustment (Calc Axis Move)

The following content is displayed in the *Detail result* area as text.

Displayed item	Description
Judge	Judgment results 0: No judgment (unmeasured) 1: Judgment result OK -1: Judgment result NG -10: Error (image format mismatch) -11: Error (unregistered model) -12: Error (insufficient memory) -20: Error (other errors)
Position X difference	Position X difference
Position Y difference	Position Y difference
Angle difference	Angle difference
Measurement X	Measurement X
Measurement Y	Measurement Y
Angle θ	Angle θ
Ref. coordinate X	Ref. coordinate X
Ref. coordinate Y	Ref. coordinate Y
Reference angle θ	Reference angle θ
X-axis movement	X-axis movement
Y-axis movement	Y-axis movement* ¹
θ -axis angle movement	θ -axis angle movement* ¹
θ -axis linear movement	θ -axis linear movement* ¹
U-axis movement	U-axis movement* ¹
V-axis movement	V-axis movement* ¹
W-axis movement	W-axis movement* ¹
R-axis movement	R-axis movement* ¹

*1. The following parameters are displayed in this menu based on the stage type.

Dis- played con- tents	XY	XY θ	θ XY	UVW	UVWR	X θ (Y θ)	θ X(θ Y)	X(Y)	3 axes	4 axes
X-axis move- ment	○	○	○	×	×	○ (When X-axis is se- lected as the move- ment axis.)	○ (When X-axis is se- lected as the move- ment axis.)	○ (When X-axis is se- lected as the move- ment axis.)	○	○

Dis- played con- tents	XY	XYθ	θXY	UVW	UVWR	Xθ(Yθ)	θX(θY)	X(Y)	3 axes	4 axes
Y-axis move- ment	○	○	○	×	×	○ (When Y-axis is se- lected as the move- ment axis.)	○ (When Y-axis is se- lected as the move- ment axis.)	○ (When Y-axis is se- lected as the move- ment axis.)	○	○
θ-axis angle move- ment	×	○ (θ-axis direct drive)	○ (θ-axis direct drive)	×	×	○ (θ-axis direct drive)	○ (θ-axis direct drive)	×	×	○
θ-axis linear move- ment	×	○ (θ-axis linear drive)	○ (θ-axis linear drive)	×	×	○ (θ-axis linear drive)	○ (θ-axis linear drive)	×	×	×
U-axis move- ment	×	×	×	○	○	×	×	×	×	×
V-axis move- ment	×	×	×	○	○	×	×	×	×	×
W-axis move- ment	×	×	×	○	○	×	×	×	×	×
R-axis move- ment	×	×	×	×	○	×	×	×	×	×

○: Displayed, ×: Not displayed

Key Points for Adjustment (Calc Axis Move)

Adjust the setting parameters referring to the following points.

- When the sign of the measurement result (positive and negative) output is opposite

Parameter to be adjust- ed	Remedy
Calculation parameter	When the sign of the measurement results (positive and negative) output is opposite, the reference position and angle and measurement position and angle might have been set in reverse. The axis movement amount calculates the movement amount from the measurement position and angle to the reference position and angle.

● Others

Parameter to be adjusted	Remedy
Machine setting	<p>When the reference unit number is <None> and cannot be selected, check if the reference scene number is selected correctly. Check if stage data processing items or robot data processing items are registered in the selected reference scene.</p> <p>The reference unit number does not change during flow editing, which is the specifications. While a scene other than the current scene is referenced, the reference unit number does not change according to the editing of the flow. Change the flow so that the current scene will be referenced, or set the reference unit number again.</p>

4-29-7 Measurement Results for Which Output Is Possible (Calc Axis Move)

The following values can be output using processing items related to result output. It is also possible to reference measurement values from calculation expressions and other processing units.

Measurement items	Character string	Description
Judge	JG	Judgment results 0: No judgment (unmeasured) 1: Judgment result OK -1: Judgment result NG -10: Error (image format mismatch) -11: Error (unregistered model) -12: Error (insufficient memory) -20: Error (other errors)
Position X difference		Position X difference
Position X difference		Position X difference
Measurement X		Measurement X
Measurement Y		Measurement Y
Angle θ	TH	Angle θ
Ref. coordinate X		Ref. coordinate X
Ref. coordinate Y		Ref. coordinate Y
Ref. angle		Ref. angle
X-axis movement		X-axis movement ^{*1}
Y-axis movement		Y-axis movement ^{*1}
θ -axis angle movement		θ -axis angle movement ^{*1}
θ -axis linear movement		θ -axis linear movement ^{*1}
U-axis movement		U-axis movement ^{*1}
V-axis movement		V-axis movement ^{*1}
W-axis movement		W-axis movement ^{*1}
R-axis movement		R-axis movement ^{*1}

*1. The following parameters are displayed in this menu based on the stage type.

Output contents	XY	XYθ	θXY	UVW	UVWR	Xθ(Yθ)	θX(θY)	X(Y)	3 axes	4 axes
X-axis movement	○	○	○	×	×	○ (When X-axis is selected as the movement axis.)	○ (When X-axis is selected as the movement axis.)	○ (When X-axis is selected as the movement axis.)	○	○
Y-axis movement	○	○	○	×	×	○ (When Y-axis is selected as the movement axis.)	○ (When Y-axis is selected as the movement axis.)	○ (When Y-axis is selected as the movement axis.)	○	○
θ-axis angle movement	×	○ (θ-axis direct drive)	○ (θ-axis direct drive)	×	×	○ (θ-axis direct drive)	○ (θ-axis direct drive)	×	×	○
θ-axis linear movement	×	○ (θ-axis linear drive)	○ (θ-axis linear drive)	×	×	○ (θ-axis linear drive)	○ (θ-axis linear drive)	×	×	×
U-axis movement	×	×	×	○	○	×	×	×	×	×
V-axis movement	×	×	×	○	○	×	×	×	×	×
W-axis movement	×	×	×	○	○	×	×	×	×	×
R-axis movement	×	×	×	×	○	×	×	×	×	×

○: Output, ×: Do not output

4-29-8 External Reference Tables (Calc Axis Move)

No.	Data name	Data ident	Set/Get	Data range
0	Judge	judge	Get only	0: No judgment (unmeasured), 1: Judgment result OK, -1: Judgment result NG, -10: Error (image format mismatch), -11: Error (unregistered model), -12: Error (insufficient memory), -20: Error (other errors)
5	X-axis movement	moveX	Get only	-
6	Y-axis movement	moveY	Get only	-
7	θ -axis movement	moveTheta	Get only	-180 to 180
8	θ -axis(linear drive)	moveLinearTheta	Get only	-
9	U-axis movement	moveU	Get only	-
10	V-axis movement	moveV	Get only	-
11	W-axis movement	moveW	Get only	-
12	R-axis movement	moveR	Get only	-
13	Reference X	standardPosX	Get only	-
14	Reference Y	standardPosY	Get only	-
15	Reference angle	standardAngle	Get only	-
16	Measurement X	measurePosX	Get only	-
17	Measurement Y	measurePosY	Get only	-
18	Measurement angle	measureAngle	Get only	-
19	Position X difference	diffX	Get only	-
20	Position Y difference	diffY	Get only	-
21	Angle difference	diffTheta	Get only	-
22	Yaw-axis movement	moveYaw	Get only	-
23	Pitch-axis movement	movePitch	Get only	-
24	Roll-axis movement	moveRoll	Get only	-
103	Reflect to overall judgement	overallJudge	Set/Get	0: ON, 1: OFF
120	Reference scene No.	sceneNo	Set/Get	-1: Current scene referred 0 to 9,999: Pointed scene referred
121	Reference unit No.	unitNo	Set/Get	-1: No reference 0 to 9,999: Pointed unit referred
130	Reference X (Movement end point)	expStdX	Set/Get	Exp. character string
131	Reference Y (Movement end point)	expStdY	Set/Get	Exp. character string
132	Reference angle (Movement end point)	expStdAngle	Set/Get	Exp. character string
133	Measurement X (Movement start point)	expMeasX	Set/Get	Exp. character string

No.	Data name	Data ident	Set/Get	Data range
134	Measurement Y (Movement start point)	expMeasY	Set/Get	Exp. character string
135	Measurement angle (Movement start point)	expMeasAngle	Set/Get	Exp. character string
140	Reference X offset	expOffsetStdX	Set/Get	Exp. character string
141	Reference Y offset	expOffsetStdY	Set/Get	Exp. character string
142	Reference angle off- set	expOffsetStdAngle	Set/Get	Exp. character string
143	Measurement X off- set	expOffsetMeasX	Set/Get	Exp. character string
144	Measurement Y off- set	expOffsetMeasY	Set/Get	Exp. character string
145	Measurement angle offset	expOffsetMeasAngle	Set/Get	Exp. character string
146	Initial angle(Refer- ence position)	explInitialStdAngle	Set/Get	Exp. character string
147	Initial angle(Meas- urement position)	explInitialMeasAngle	Set/Get	Exp. character string
150	Current X-axis move- ment (Movement start point)	currentPosX	Set/Get	Exp. character string
151	Current Y-axis move- ment (Movement start point)	currentPosY	Set/Get	Exp. character string
152	Current θ -axis move- ment (Movement start point)	currentPosTheta	Set/Get	Exp. character string
153	Current θ -axis(linear drive) (Movement start point)	currentPosLinear- Theta	Set/Get	Exp. character string
154	Current U-axis movement (Move- ment start point)	currentPosU	Set/Get	Exp. character string
155	Current V-axis move- ment (Movement start point)	currentPosV	Set/Get	Exp. character string
156	Current W-axis movement (Move- ment start point)	currentPosW	Set/Get	Exp. character string
157	Current R-axis movement (Move- ment start point)	currentPosR	Set/Get	Exp. character string
160	Upper limit of X-axis movement	upperMoveX	Set/Get	-99,999.9999 to 99,999.9999
161	Lower limit of X-axis movement	lowerMoveX	Set/Get	-99,999.9999 to 99,999.9999
162	Upper limit of Y-axis movement	upperMoveY	Set/Get	-99,999.9999 to 99,999.9999

No.	Data name	Data ident	Set/Get	Data range
163	Lower limit of Y-axis movement	lowerMoveY	Set/Get	-99,999.9999 to 99,999.9999
164	Upper limit of θ -axis movement	upperMoveTheta	Set/Get	-180 to 180
165	Lower limit of θ -axis movement	lowerMoveTheta	Set/Get	-180 to 180
166	Upper limit of θ -axis (linear drive)	upperMoveLinear-Theta	Set/Get	-99,999.9999 to 99,999.9999
167	Lower limit of θ -axis (linear drive)	lowerMoveLinear-Theta	Set/Get	-99,999.9999 to 99,999.9999
168	Upper limit of U-axis movement	upperMoveU	Set/Get	-99,999.9999 to 99,999.9999
169	Lower limit of U-axis movement	lowerMoveU	Set/Get	-99,999.9999 to 99,999.9999
170	Upper limit of V-axis movement	upperMoveV	Set/Get	-99,999.9999 to 99,999.9999
171	Lower limit of V-axis movement	lowerMoveV	Set/Get	-99,999.9999 to 99,999.9999
172	Upper limit of W-axis movement	upperMoveW	Set/Get	-99,999.9999 to 99,999.9999
173	Lower limit of W-axis movement	lowerMoveW	Set/Get	-99,999.9999 to 99,999.9999
174	Upper limit of R-axis movement	upperMoveR	Set/Get	-99,999.9999 to 99,999.9999
175	Lower limit of R-axis movement	lowerMoveR	Set/Get	-99,999.9999 to 99,999.9999
176	Output type	outputType	Set/Get	0: Relative position 1: Absolute position
190	Current Yaw-axis movement (Movement start point)	currentPosYaw	Set/Get	Exp. character string
191	Current Pitch-axis movement (Movement start point)	currentPosPitch	Set/Get	Exp. character string
192	Current Roll-axis movement (Movement start point)	currentPosRoll	Set/Get	Exp. character string
193	Upper limit of Yaw-axis movement	upperMoveYaw	Set/Get	-180 to 180
194	Lower limit of Yaw-axis movement	lowerMoveYaw	Set/Get	-180 to 180
195	Upper limit of Pitch-axis movement	upperMovePitch	Set/Get	-180 to 180
196	Lower limit of Pitch-axis movement	lowerMovePitch	Set/Get	-180 to 180
197	Upper limit of Roll-axis movement	upperMoveRoll	Set/Get	-180 to 180
198	Lower limit of Roll-axis movement	lowerMoveRoll	Set/Get	-180 to 180

4-30 Calc Axis Move by Multipoint

This processing item calculates each axis movement amount of the external equipment required for matching the measurement position and angle to the reference position and angle. Those position and angle are set with an expression.

At least 2 or 3 measurement points are needed to calculate axis movement amounts. Axis movement amounts can usually be stably calculated by installing a camera at each measurement point and measuring 4 or 5 measurement points.

In the basic approach, measurement amounts are precisely calculated by preparing the same number of cameras as the number of measurement points. Also, it is also possible to measure multiple measurement points contained in a single camera's field of view.

Used in the Following Case

When positioning the FPD panel:

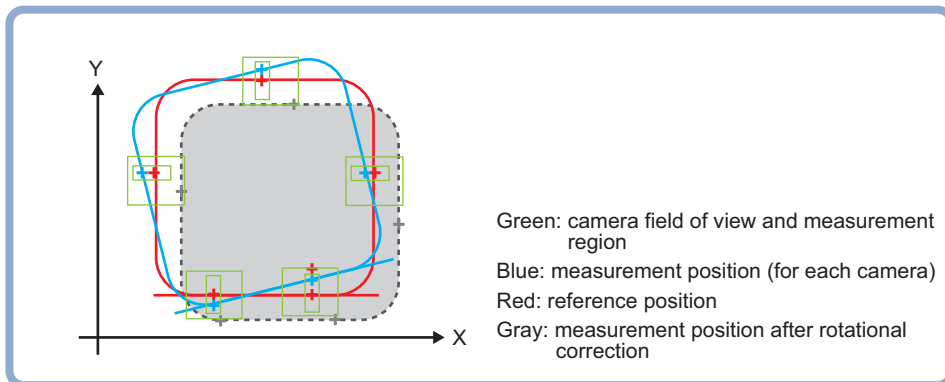

4-30-1 Settings Flow (Calc Axis Move by Multipoint)

To set Calc Axis Move by Multipoint, follow the steps below.

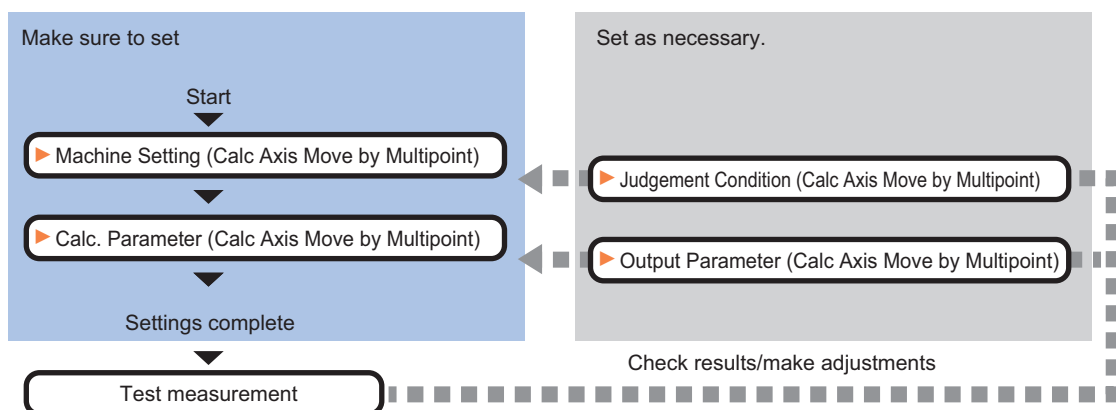

List of Calc Axis Move by Multipoint Items

Item	Description
Machine setting	Selects a processing item such as <i>Stage Data</i> or <i>Robot Data</i> under which external device information needed for calculation travel distance of the actuator is held. <i>4-30-2 Machine Setting (Calc Axis Move by Multipoint)</i> on page 4-213
Calc parameter	Sets the reference position and measurement position using a calculation expression. <i>4-30-3 Calc. Parameter (Calc Axis Move by Multipoint)</i> on page 4-214
Judgment condition	Sets processing conditions for measurement and judgment conditions for measurement results. <i>4-30-4 Judgement Condition (Calc Axis Move by Multipoint)</i> on page 4-219
Output parameter	This item can be changed as necessary. Selects whether or not to reflect the judgment result to the overall judgment of the scene. <i>4-30-5 Output Parameter (Calc Axis Move by Multipoint)</i> on page 4-222

4-30-2 Machine Setting (Calc Axis Move by Multipoint)

Select a processing item such as *Stage Data* or *Robot Data* under which external device information needed for calculation of axis movement amount of the actuator is held.

- 1 In the Item tab area, click **Machine setting**.
- 2 Select a processing unit holding the external device information.
The information of the selected processing unit is displayed in the *Reference data display* area.
Displayed contents vary depending on the selected type of robot or stage.

Machine setting data

Reference scene No. : Present scene

Reference unit No. : 2 Stage data

Reference data

Stage type : XY stage

Setting item	Setting value [Factory default]	Description
Reference scene No.	[Present scene] Scene 0 to 127	Selects the scene number including a processing item such as <i>Stage Data</i> or <i>Robot Data</i> under which the external device information needed for calculating the axis movement amount of the actuator is held.
Reference No.	-	From among the referenced scene numbers, selects a processing item such as <i>Stage Data</i> or <i>Robot Data</i> under which the external device information needed for calculating the axis movement amount of the actuator is held.
Reference data	-	Displays the settings of <i>Stage Data</i> or <i>Robot Data</i> processing item.



Additional Information

When the number of scenes is increased with the scene group conversion tool, the upper limit value that is selectable in *Reference scene No.* is changed.

4-30-3 Calc. Parameter (Calc Axis Move by Multipoint)

Here set the reference position and measurement position using a calculation expression. Displayed parameters vary depending on the type of stage selected.

- 1 In the Item Tab area, click **Calc. parameter**.
- 2 In the *Measure type* area, select the measurement method.

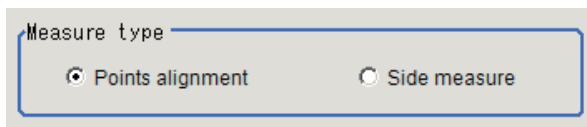

Setting item	Setting value [Factory default]	Description
Measure type	<ul style="list-style-type: none"> • [Points alignment] • side measure 	<p>Selects the measurement method for the maximum error in the judgment condition.</p> <ul style="list-style-type: none"> • Points alignment Calculates each movement amount from the measurement position to the reference position based on the supported position information. It is suitable when you want to keep the distance between all points within a certain range. • Side measure: This is an alignment method to measures sides (edges) of workpieces. This method can be used even if alignment marks are missing or angle of a workpiece cannot be measured.

Points alignments

Use the procedure below to measure position and angle by detecting a point you want to position on the object to measure. The movement amount of each axis is calculated from the measurement results.

For point measurement, a processing item such as *Search*, which outputs the measured X and Y coordinates, is used. Use the measurement processing item, which outputs measured X and Y coordinates for each measurement point, after registering it in the measurement flow.

- 1 Set the reference position and measurement position in the *Position setting* area.

Position setting

The number of points :

No.	Reference position X	Reference position Y	Measured position X	Measured position Y
0				
1				
2				
3				

No.0 Reference position Measured position

X: X:

Y: Y:

Setting item	Setting value [Factory default]	Description
The number of points	2 to 8 [4]	Sets the number of points to measure.
Reference position X	-	Sets the X coordinate of the reference position.
Reference position Y	-	Sets the Y coordinate of the reference position.
Measured position X	-	Sets the X coordinate of the measurement position.
Measured position Y	-	Sets the Y coordinate of the measurement position.

2 Set each item in the **Matching method** area.

Matching method

Least square method Maximum error minimization

Setting item	Setting value [Factory default]	Description
Matching method	<ul style="list-style-type: none"> [Least square method] Maximum error minimization 	<ul style="list-style-type: none"> Least square method: Performs positioning so that the sum of squares of errors in all points*1 become the minimum. Maximum error minimization: Performs positioning so that the maximum value of the errors in all points*1 become the minimum.

*1. Errors in all points: Distance between the reference position and the measurement position

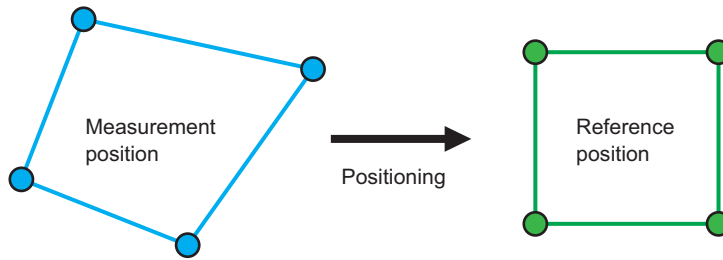

Positioning result image

Least square method

The sum of squares of errors become the minimum.
Reduces effects of noise point.

Maximum error minimization

The maximum value of errors of all points become the minimum.
Points with extremely large errors are not generated.

3 Set the noise reduction method in the *Noise removal setting* area.



Setting item	Setting value [Factory default]	Description
Required point number for calc	2 to 8 [4]	Sets the number of marks required for the alignment, which is left after removing noise points. Sets the number of marks required for the alignment, which is left after removing noise points. For instance, when the number of points is set to four for position settings and the required minimum number of points is set to three, the number of noise removal points is either zero or one.
Error tolerance	0 to 99,999.9999 [0.0000]	Sets acceptable error (a distance between measurement position and reference position) to calibrate. Performing the calibration by removing the noise points repeatedly until the required minimum number of points is reached. When the Error tolerance is set to 0.0000, all points combinations are calculated and the result with the minimum error value is output.

The noise removal flow is explained by using a sample case that the required minimum points is 2 points, and that the allowable error is 10.0.
Flow of noise removal

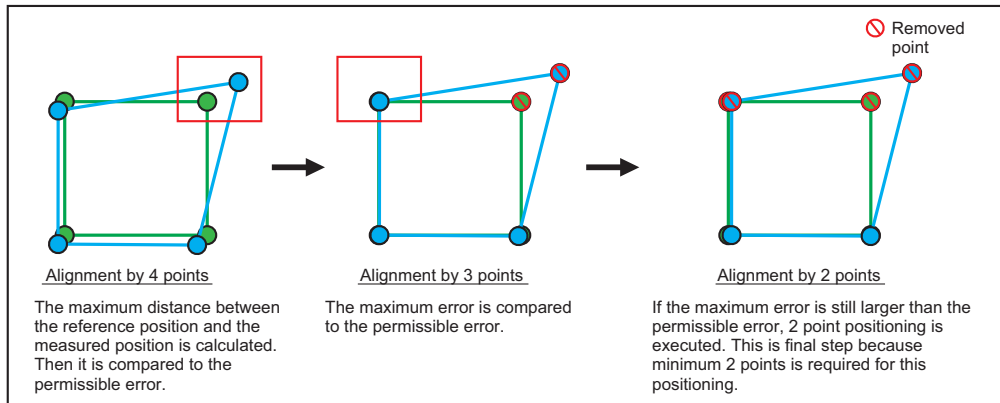

4 Set the current axis position.

Current axis position

X-axis :

Y-axis :

Set the axis position of an external device.



Additional Information

When you select X θ , Y θ , θ X, θ Y, X, or Y stage, non-existent axis will be grayed out and you cannot set it. Only existing axes can be set.

Side measurement

Use the procedure below to measure position and angle by detecting the edges of the sides of a rectangular or square measurement object. The movement amount of each axis is calculated from the measurement results. Be sure to set two or more points as the measurement points measuring the same side.

For side (edge) measurement, use *Edge Position* processing item. Register and use *Edge Position* processing item for each measurement point in the measurement flow. If a processing item other than *Edge Position* processing item is used for the measurement, a movement amount may not be calculated properly.

1 In the *Position setting* area, set the number of points, measured axis, reference position, and measured position.

Position setting

The number of points :

No.	Measured axis	Reference position X	Reference position Y	Measured position X	Measured position Y
0	X-axis side1				
1	X-axis side1				
2	X-axis side1				
3	X-axis side1				
4	X-axis side1				

No.0 Measure axis : X-axis side1 X-axis side2 Y-axis side1 Y-axis side2

Reference position X: Y:

Measured position X: Y:

Setting item	Setting value [Factory default]	Description
The number of points	3 to 8 [5]	Sets how many points to measure in the four sides.
Measured axis	<ul style="list-style-type: none"> • [X-axis side 1] • X-axis side 2 • Y-axis side 1 • Y-axis side 2 	<p>Sets the measurement axis.</p> <p>For the measurement axis, make sure to set the axis of an actual coordinate system that is parallel to the direction of measurement region for Edge Position processing item to be used in measurement.</p>
Reference position X	-	Sets the X coordinate of the reference position.
Reference position Y	-	Sets the Y coordinate of the reference position.
Measured position X	-	Sets the X coordinate of the measurement position.
Measured position Y	-	Sets the Y coordinate of the measurement position.

2 In *Angle setting* area, specify the measurement axis and setting type.

Angle setting

Measure axis : X-axis Y-axis

Setting type : 2 points setting Calculation setting

Point 0 :

Point 1 :

Setting item	Setting value [Factory default]	Description
Measure axis	<ul style="list-style-type: none"> • [X-axis] • Y-axis 	<p>Set the measurement axis used for angle calculation.</p> <p>This is enabled when <i>2 points setting</i> is specified in the <i>Setting type</i>.</p>
Setting type	<ul style="list-style-type: none"> • [2 points setting] • Calculation setting 	<p>Sets the angle specification method.</p> <ul style="list-style-type: none"> • 2 Points setting: Sets the measurement axis used for angle calculation by specifying two points on the same side. • Calculation setting: Sets the reference angle and measurement angle with a calculation expression respectively.
Point 0	-	This is enabled when <i>2 points setting</i> is specified in the <i>Setting type</i> .
Point 1	-	<p>Selects each of two points from points set in the <i>Position setting</i> area.</p> <p>For the two points selected, ensure to select measurement points on the same side.</p>
Reference angle	-	This is enabled when <i>Calculation setting</i> is specified in the <i>Setting type</i> .
Measured angle	-	Sets the reference angle and measurement angle with a calculation expression respectively.

Example: When measuring edge positions at five points on the sides

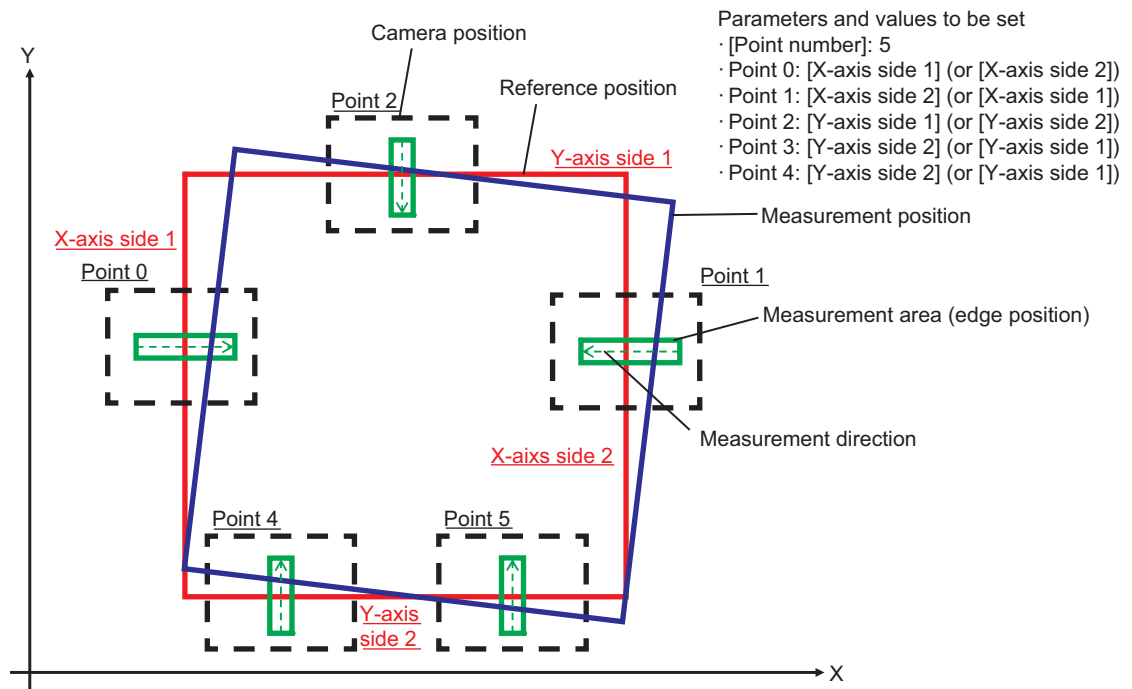

Precautions for Correct Use

Make sure to use *Edge Position* processing item for edge measurement. The movement amount will not be calculated properly if you use a processing item other than **Edge Position** processing item.



Additional Information

For measurement regions of two locations on one side (edge) to calculate an angle, the wider the distance between the measurement regions, the higher the accuracy to calculate the angle.

- 3 Set the current axis position.
Set the axis position of the external device.

Current axis position

X-axis :

Y-axis :



Additional Information

For X, Y, X θ , Y θ , θ X, or θ Y stage, only existent axis or an axis set as a movement axis can be set. non-existent axis will no be displayed.

4-30-4 Judgement Condition (Calc Axis Move by Multipoint)

This item specifies the condition for measurement results.

- 1 In the Item tab area, click **Judgment condition**.

- 2** In the *Judgment condition* area, set each item.
 <When the reference data is the UVWR stage>

Setting item	Setting value [Factory default]	Description
Axis movement	-99999.9999 to 99999.9999	Sets the upper and lower limit values for the movement amount in the axis direction. The settable axis varies depending on processing items holding external device information specified in the Machine setting.
Error max	0 to 99999.9999 [99999.9999]	This is enabled when <i>Measure type</i> in the Calc. parameter tab is set to <i>Points alignment</i> . Sets the upper and lower limit values for a maximum error between the reference position and the measurement position.

Displayed parameters vary depending on the type of stage selected.

Dis- played contents	No t se- lec- ted	XY	XY θ	θ XY	UV W	UV W R	X θ (Y θ)	θ X(θ Y)	X(Y)	3 ax- es	4 ax- es
X-axis movement amount judgement upper and lower limit values	<input type="radio"/>	<input type="radio"/>	<input type="radio"/>	<input type="radio"/>	-	-	<input type="radio"/> (X-axis is selected as the movement axis.)	<input type="radio"/> (X-axis is selected as the movement axis.)	<input type="radio"/> (X-axis is selected as the movement axis.)	<input type="radio"/>	<input type="radio"/>
Y-axis movement amount judgement upper and lower limit values	<input type="radio"/>	<input type="radio"/>	<input type="radio"/>	<input type="radio"/>	-	-	<input type="radio"/> (Y-axis is selected as the movement axis.)	<input type="radio"/> (Y-axis is selected as the movement axis.)	<input type="radio"/> (Y-axis is selected as the movement axis.)	<input type="radio"/>	<input type="radio"/>

Dis- played contents	No t se- lec- ted	XY	XYθ	θXY	UV W	UV W R	Xθ(Yθ)	θX(θY)	X(Y)	3 ax- es	4 ax- es
θ-axis move- ment amount judge- ment up- per and lower lim- it values	○	-	○ (θ-axis direct drive)	○ (θ-axis direct drive)	-	-	○ (θ-axis direct drive)	○ (θ-axis direct drive)	-	-	○
θ-axis lin- ear move- ment amount judge- ment up- per and lower lim- it values	-	-	○ (θ-axis direct drive)	○ (θ-axis direct drive)	-	-	○ (θ-axis direct drive)	○ (θ-axis direct drive)	-	-	-
U- axis move- ment amount judge- ment up- per and lower lim- it values	-	-	-	-	○	○	-	-	-	-	-
V- axis move- ment amount judge- ment up- per and lower lim- it values	-	-	-	-	○	○	-	-	-	-	-
W- axis move- ment amount judge- ment up- per and lower lim- it values	-	-	-	-	○	○	-	-	-	-	-

Dis- played contents	No t se- lec- ted	XY	XY θ	θ XY	UV W	UV W R	X θ (Y θ)	θ X(θ Y)	X(Y)	3 ax- es	4 ax- es
R- axis move- ment amount judge- ment up- per and lower lim- it values	-	-	-	-	-	o	-	-	-	-	-

o: Displayed, - : Not displayed

4-30-5 Output Parameter (Calc Axis Move by Multipoint)

Here sets how to handle the coordinates to be output to external devices as measurement results. This item can be changed as necessary. Normally, the factory default value will be used.

1 In the Item tab area, click **Output parameter**.

2 Set each item.

Setting item	Setting value [Factory default]	Description
Reflect to overall judgment	<ul style="list-style-type: none"> [ON] OFF 	Enables choosing whether or not the judgement results of this processing unit is reflected in the scene overall judgment.
Output type	<ul style="list-style-type: none"> [Relative position] Absolute position 	<ul style="list-style-type: none"> Relative position: Calculates the movement amount from the current axis position. Absolute position: Calculates the movement amount from the Homing operation position.

4-30-6 Key Points for Test Measurement and Adjustment (Calc Axis Move by Multipoint)

The following content is displayed in the *Detail result* area as text.

Displayed item	Description
Judge	Judgment results 0: No judgment (unmeasured) 1: Judgment result OK -1: Judgment result NG -10: Error (image format mismatch) -11: Error (unregistered model) -12: Error (insufficient memory) -20: Error (other errors)
X-axis movement	The following parameters are displayed in this menu based on the stage type.
Y-axis movement	Y-axis movement

Displayed item	Description
θ-axis angle movement	θ-axis angle movement*1
θ-axis linear movement	θ-axis linear movement*1
U-axis movement	U-axis movement
V-axis movement	V-axis movement
W-axis movement	W-axis movement
R-axis movement	R-axis movement
Position X difference	Position X difference
Position Y difference	Position Y difference
Angle difference	Angle difference
Maximum error	Maximum error

*1. The following parameters are displayed in this menu based on the stage type.

Dis- played con- tents	XY	XYθ	θXY	UVW	UVWR	Xθ(Yθ)	θX(θY)	X(Y)	3 axes	4 axes
θ-axis angle move- ment	x	○ (θ-axis direct drive)	○ (θ-axis direct drive)			○ (θ-axis direct drive)	○ (θ-axis direct drive)	x		○
θ-axis linear move- ment	x	○ (θ-axis linear drive)	○ (θ-axis linear drive)	x	x	○ (θ-axis linear drive)	○ (θ-axis linear drive)	x	x	x

○: Displayed, ×: Not displayed

Key Points for Adjustment (Calc Axis Move by Multipoint)

Adjust the setting parameters referring to the following points.

- **The sign of the measurement result (positive and negative) that has been output is opposite**

Parameter to be adjust- ed	Remedy
Calculation parameter	When the sign of the measurement results (positive and negative) output is opposite, the reference position and angle and measurement position and angle might have been set in reverse. The axis movement amount calculates the movement amount from the measurement position and angle to the reference position and angle.

● Others

Parameter to be adjusted	Remedy
Machine setting	<p>When the reference unit number is <None> and cannot be selected, check if the reference scene number is selected correctly.</p> <p>Check if stage data processing items or robot data processing items are registered in the selected reference scene.</p>
	<p>The reference unit number does not change during flow editing, which is the specifications.</p> <p>While a scene other than the current scene is referenced, the reference unit number does not change according to the editing of the flow. Change the flow so that the current scene will be referenced, or set the reference unit number again.</p>

4-30-7 Measurement Results for Which Output Is Possible (Calc Axis Move by Multipoint)

The following values can be output using processing items related to result output. It is also possible to reference measurement values from calculation expressions and other processing units.

Measurement items	Character string	Description
Judge	JG	Judgment results 0: No judgment (unmeasured) 1: Judgment result OK -1: Judgment result NG -10: Error (image format mismatch) -11: Error (unregistered model) -12: Error (insufficient memory) -20: Error (other errors)
X-axis movement	MX	X-axis movement* ¹
Y-axis movement	MY	Y-axis movement* ¹
θ-axis angle movement	MT	θ-axis angle movement
θ-axis linear movement	ML	θ-axis linear movement
U-axis movement	MU	U-axis movement
V-axis movement	MV	V-axis movement
W-axis movement	MW	W-axis movement
R-axis movement	MR	R-axis movement
Position X difference	DX	Position X difference
Position Y difference	DY	Position Y difference
Angle difference	DT	Angle difference
Maximum error	MAXE	Maximum error
Minimum error	MINE	Minimum error
Average error	AVEE	Average error
No. of removed points	RPN	No. of removed points

*1. The following parameters are displayed in this menu based on the stage type.

Output contents	XY	XYθ	θXY	UVW	UVWR	Xθ(Yθ)	θX(θY)	X(Y)	3 axes	4 axes
θ-axis angle movement	x	○ (θ-axis direct drive)	○ (θ-axis direct drive)			○ (θ-axis direct drive)	○ (θ-axis direct drive)	x		○
θ-axis linear movement	x	○ (θ-axis linear drive)	○ (θ-axis linear drive)	x	x	○ (θ-axis linear drive)	○ (θ-axis linear drive)	x	x	x

○: Output, x: Do not output

4-30-8 External Reference Tables (Calc Axis Move by Multipoint)

No.	Data name	Data ident	Set/Get	Data range
0	Judge	judge	Get only	0: No judgment (unmeasured), 1: Judgment result OK, -1: Judgment result NG, -10: Error (image format mismatch), -11: Error (unregistered model), -12: Error (insufficient memory), -20: Error (other errors)
5	X-axis movement	moveX	Get only	-
6	Y-axis movement	moveY	Get only	-
7	θ-axis movement	moveTheta	Get only	-180 to 180
8	θ-axis(linear drive)	moveLinearTheta	Get only	-
9	U-axis movement	moveU	Get only	-
10	V-axis movement	moveV	Get only	-
11	W-axis movement	moveW	Get only	-
12	R-axis movement	moveR	Get only	-
13	Position X difference	diffX	Get only	-
14	Position Y difference	diffY	Get only	-
15	Angle difference	diffTheta	Get only	-
16	Error max.	errorMax	Get only	-
17	Error min.	errorMin	Get only	-
18	Error ave.	errorAve	Get only	-
19	The number of removal points	removalPointNum	Get only	-
103	Reflect to overall judgement	overallJudge	Set/Get	0: ON, 1: OFF
120	Reference scene No.	sceneNo	Set/Get	-1: Current scene referred 0 to 9,999: Pointed scene referred
121	Reference unit No.	unitNo	Set/Get	-1: No reference 0 to 9,999: Pointed unit referred
122	Measure type	measureType	Set/Get	0: Side alignment 1: Points alignment

No.	Data name	Data ident	Set/Get	Data range
123	Expressions of reference angle	expSideStdAngle	Set/Get	Exp. character string
124	Expressions of measurement angle	expSideMeasAngle	Set/Get	Exp. character string
125	Measure axis of angle setting	angleAxis	Set/Get	0: X-axis, 1: Y-axis
126	Setting type	angleMethod	Set/Get	0: 2 points setting 1: Calculation setting
127	Point 0	anglePoint0	Set/Get	-1: Unselected 0 to 7: No.0 to No.7
128	Point 1	anglePoint1	Set/Get	-1: Unselected 0 to 7: No.0 to No.7
129	Side alignment's point number	pointNumSide	Set/Get	3 to 8
130	Required number of points for calc.	pointNumMulti	Set/Get	2 to 8
131	Minimum required points	pointNumMin	Set/Get	2 to 8
132	Error tolerance	errorPermit	Set/Get	0 to 99,999.9999
133	Upper limit of error	upperError	Set/Get	0 to 99,999.9999
134	Matching method	matchingMethod	Set/Get	0: Least square method 1: Maximum error minimization
150	Current X-axis movement	currentPosX	Set/Get	Exp. character string
151	Current Y-axis movement	currentPosY	Set/Get	Exp. character string
152	Current θ -axis movement	currentPosTheta	Set/Get	Exp. character string
153	Current θ -axis (linear drive)	currentPosLinear-Theta	Set/Get	Exp. character string
154	Current U-axis movement	currentPosU	Set/Get	Exp. character string
155	Current V-axis movement	currentPosV	Set/Get	Exp. character string
156	Current W-axis movement	currentPosW	Set/Get	Exp. character string
157	Current R-axis movement	currentPosR	Set/Get	Exp. character string
160	Upper limit of X-axis movement	upperMoveX	Set/Get	-99,999.9999 to 99,999.9999
161	Lower limit of X-axis movement	lowerMoveX	Set/Get	-99,999.9999 to 99,999.9999
162	Upper limit of Y-axis movement	upperMoveY	Set/Get	-99,999.9999 to 99,999.9999
163	Lower limit of Y-axis movement	lowerMoveY	Set/Get	-99,999.9999 to 99,999.9999
164	Upper limit of θ -axis movement	upperMoveTheta	Set/Get	-180 to 180

No.	Data name	Data ident	Set/Get	Data range
165	Lower limit of θ -axis movement	lowerMoveTheta	Set/Get	-180 to 180
166	Upper limit of θ -axis (linear drive)	upperMoveLinear-Theta	Set/Get	-99,999.9999 to 99,999.9999
167	Lower limit of θ -axis (linear drive)	lowerMoveLinear-Theta	Set/Get	-99,999.9999 to 99,999.9999
168	Upper limit of U-axis movement	upperMoveU	Set/Get	-99,999.9999 to 99,999.9999
169	Lower limit of U-axis movement	lowerMoveU	Set/Get	-99,999.9999 to 99,999.9999
170	Upper limit of V-axis movement	upperMoveV	Set/Get	-99,999.9999 to 99,999.9999
171	Lower limit of V-axis movement	lowerMoveV	Set/Get	-99,999.9999 to 99,999.9999
172	Upper limit of W-axis movement	upperMoveW	Set/Get	-99,999.9999 to 99,999.9999
173	Lower limit of W-axis movement	lowerMoveW	Set/Get	-99,999.9999 to 99,999.9999
174	Upper limit of R-axis movement	upperMoveR	Set/Get	-99,999.9999 to 99,999.9999
175	Lower limit of R-axis movement	lowerMoveR	Set/Get	-99,999.9999 to 99,999.9999
176	Output type	outputType	Set/Get	0: Relative position 1: Absolute position
200+N (N=0 to 7)	Expression N of reference position X	expStdX0 to expStdX7	Set/Get	Exp. character string
300+N (N=0 to 7)	Expression N of reference position Y	expStdY0 to expStdY7	Set/Get	Exp. character string
400+N (N=0 to 7)	Expression N of measurement position X	expMeasX0 to expMeasX7	Set/Get	Exp. character string
500+N (N=0 to 7)	Expression N of measurement position Y	expMeasY0 to expMeasY7	Set/Get	Exp. character string
600+N (N=0 to 7)	Measure axis	measAxis0 to measAxis7	Set/Get	0: X-axis side1, 1: X-axis side2, 2: Y-axis side1, 3: Y-axis side2

4-31 Detection Point

This processing item is not available in the FHV series.

This processing item gets the position and angle information by referencing the coordinate values measured with measurement processing units. Measurement can be performed based on precise detection points and reference position data by referencing this processing unit from the processing units having such information.

Used in the Following Case

When using the measurement results of other processing units as detection points:

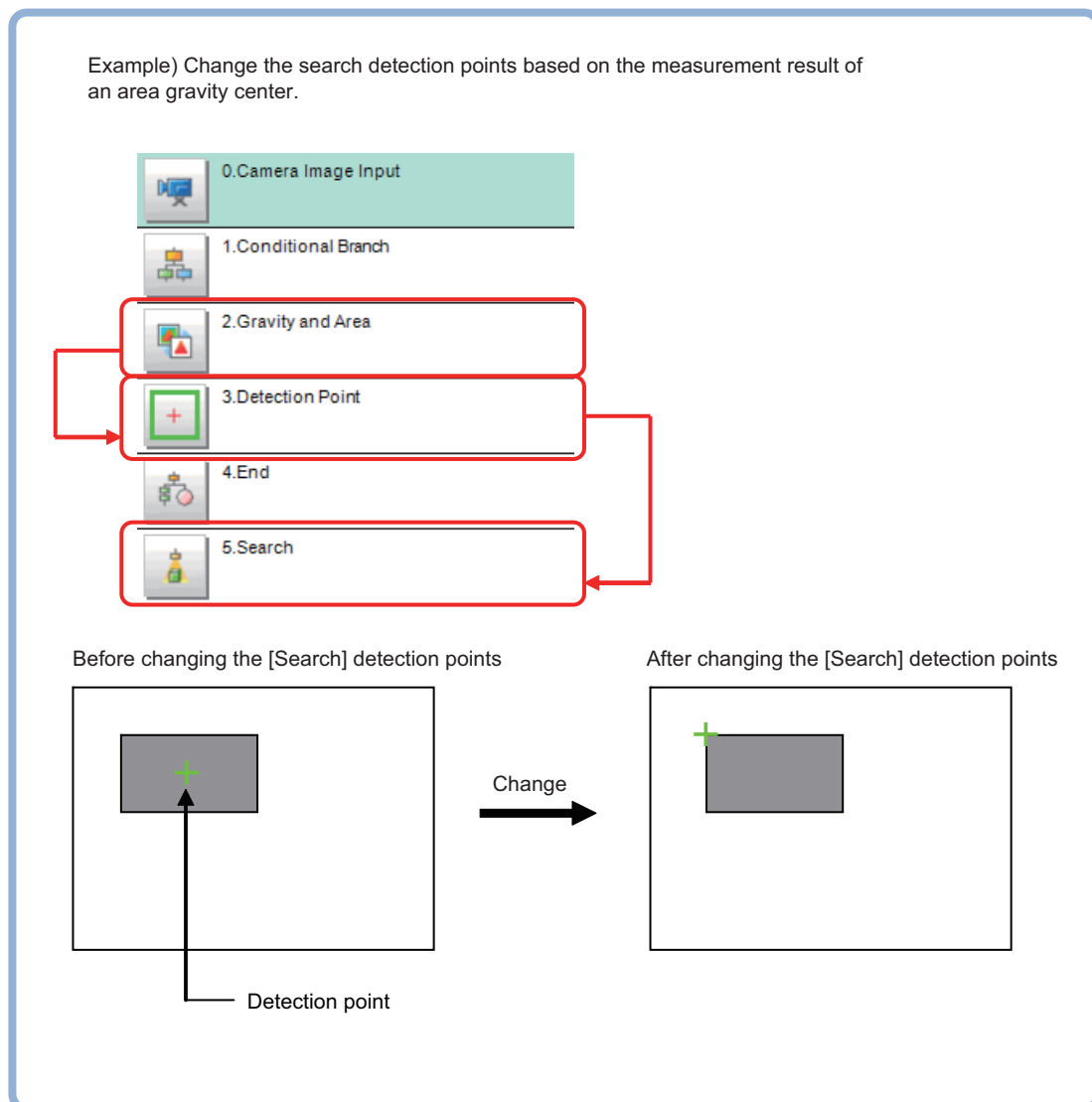

4-31-1 Parameter Setting (Detection Point)

Set how to obtain position and angle data necessary to set detection points.

- 1 In the *Setting type* area, select the setting method for detection points.

Setting item	Setting value [Factory default]	Description
Setting type	<ul style="list-style-type: none"> • [Nearest unit] • Calculation 	<ul style="list-style-type: none"> • Nearest unit: Calculates the position and angle used for the detection point from data in the previous processing unit. The judgment of this processing unit will be NG when the previous processing unit does not have X and Y in calculation strings. • Calculation: Calculates the position and angle used for the detection point by a calculation expression. Selecting this enables the <i>Position and angle</i> area.

● When *Calculation* is selected in the *Setting type*

- 1 In the *Position angle* area, set the position and angle used for the detection point with a calculation expression.
For details, refer to 4-3-3 *Layout of Setting Expression Window (Calculation)* on page 4-12.

- 2 In the *Setting data* area, you can check the values for the position and angle used for the detection point.
The calculation result specified in the **Setting type** and *Position angle* area will be displayed. If the values are not updated, once exit the setting screen and perform the measurement before displaying it again.

4-31-2 Measurement Results for Which Output Is Possible (Detection Point)

The following values can be output using processing items related to result output. It is also possible to reference measurement values from calculation expressions and other processing units.

Measurement items	Character string	Description
Judge	JG	Judgment results 0: No judgment (unmeasured) 1: Judgment result OK -1: Judgment result NG -10: Error (image format mismatch) -11: Error (unregistered model) -12: Error (insufficient memory) -20: Error (other errors)
Point X	X	X coordinate of the detection position to be retained
Point Y	Y	Y coordinate of the detection position to be retained
Angle	TH	Detection angle to be retained

4-31-3 External Reference Tables (Detection Point)

No.	Data name	Data ident	Set/Get	Data range
0	Judgement	judge	Get only	0: No judgment (unmeasured), 1: Judgment result OK, -1: Judgment result NG, -10: Error (image format mismatch), -11: Error (unregistered model), -12: Error (insufficient memory), -20: Error (other errors)
5	Position X	positionX	Get only	-99,999.9999 to 99,999.9999
6	Position Y	positionY	Get only	-99,999.9999 to 99,999.9999
7	Angle	angle	Get only	-180 to 180
120	Method	settingType	Set/Get	0: Nearest unit 1: Expression
121	Position X	setPosX	Set/Get	Exp. character string
122	Position Y	setPosY	Set/Get	Exp. character string
123	Angle	setPosTH	Set/Get	Exp. character string
124	Position X	resultPosX	Set/Get	-99,999.9999 to 99,999.9999
125	Position Y	resultPosY	Set/Get	-99,999.9999 to 99,999.9999
126	Angle	resultPosTH	Set/Get	-180 to 180

4-32 Manual Position Setting

This processing item is not available in the FHV series.

When failed to measure such as an alignment mark, an operator can specify the coordinates manually and directly by using the **Manual Position Setting** processing unit function in combination with a processing unit such as **Search** to detect an alignment mark.

When the alignment marks successfully detected, the specified coordinates will be the measurement result.

When measurement of alignment marks failed in a measurement unit such as **Search**, a user manually specifies the coordinates of alignment marks manually while checking the **Manual Position Setting** screen to be displayed. The outcome will be the measurement result.

There are two ways to launch the Manual Position Setting function.

- Communication command startup:
Higher-level devices such as PLC check a transmitted measurement data from the Sensor controller. If the **Position setting request flag** was set, then the device judge the measurement failed and send a measurement command for re-measurement. The command opens the **Manual Position Setting** screen.
- Auto startup during measurement:
When a judgement result of a processing unit such as **Search** became NG, the **Manual Position Setting** processing unit opens the **Manual Position Setting** screen.

Position setting request flag:	<p>0 means "Not need position setting", and 1 means "Need position setting". The default value is 0. When the measurement is NG and Position setting is required, this item will be 1. When the manual position setting is completed on the Position setting screen, it will be 0.</p>
Position setting complete flag:	<p>0 means "Not yet position setting", and 1 means "Position setting is completed". The default value is 0. When the manual position setting is completed on the Position setting screen, it will be 1.</p>

Communication command startup:

Measurement OK (Alignment marks could be detected.)

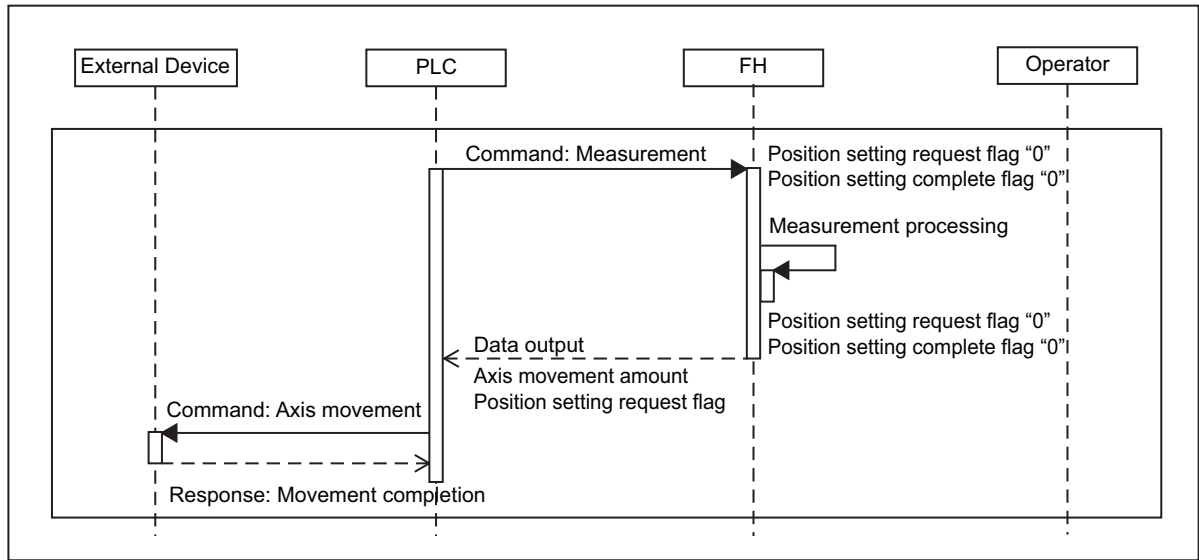

Measurement NG (Alignment marks could not be detected.)

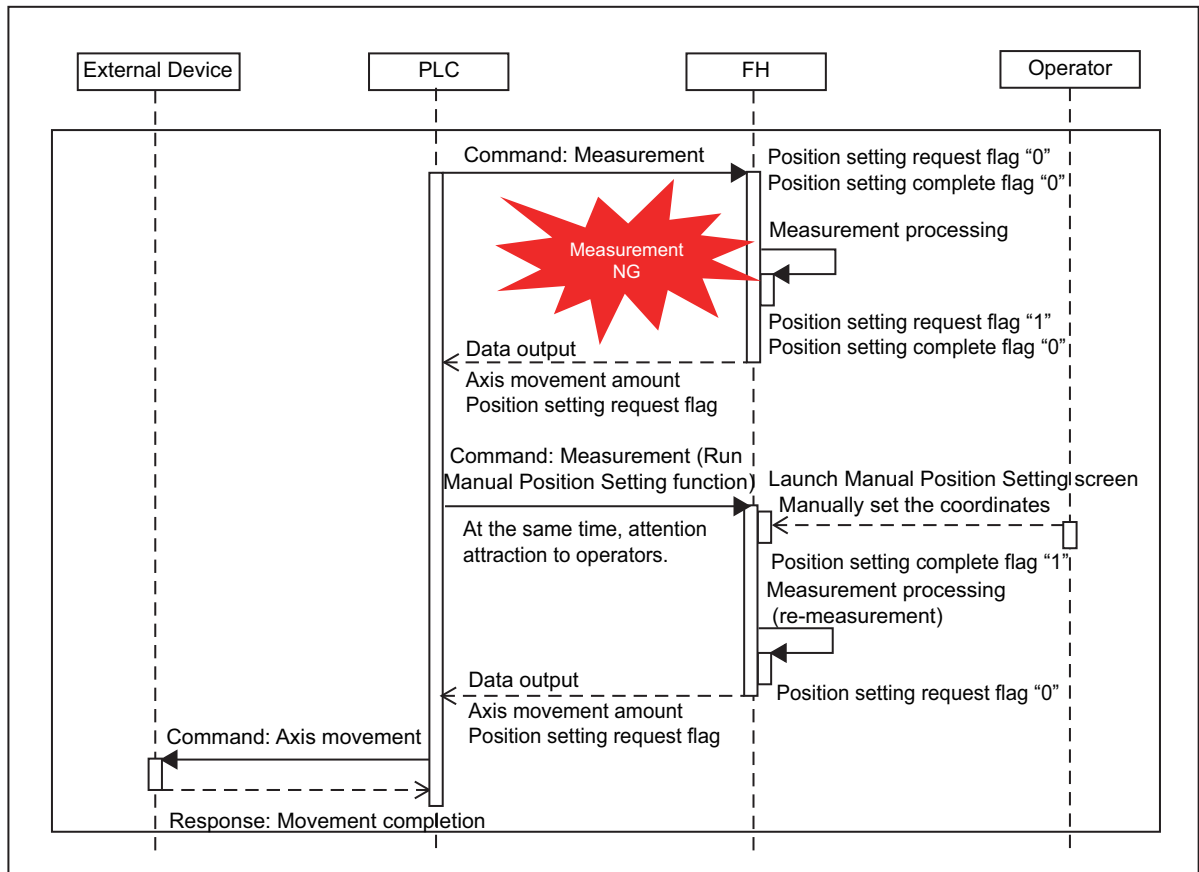

Auto startup during measurement:

Measurement OK (Alignment marks could be detected.)

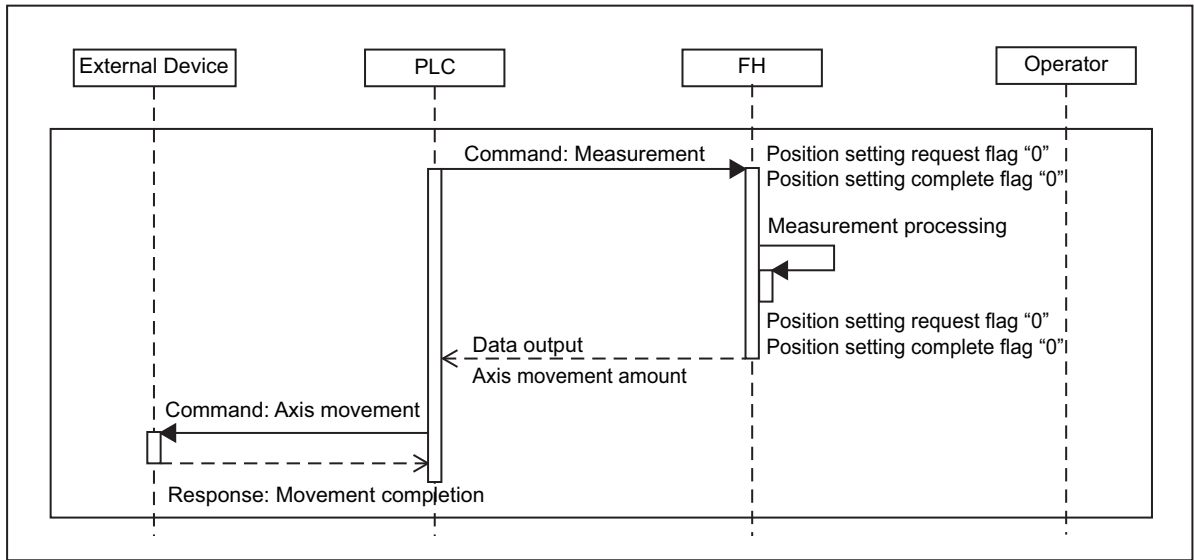

Measurement NG (Alignment marks could not be detected.)

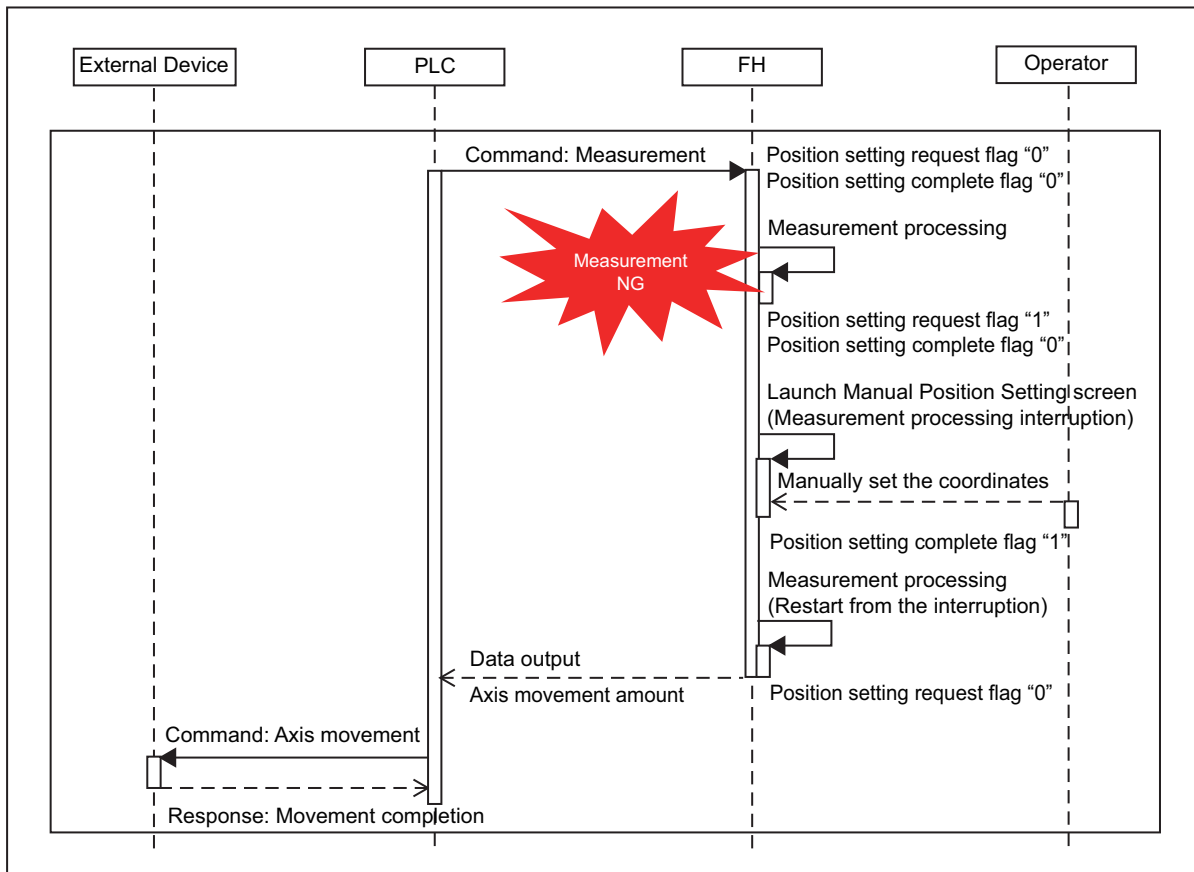

Used in the Following Case

When measurement for alignment marks failed and the measurement flow stopped:

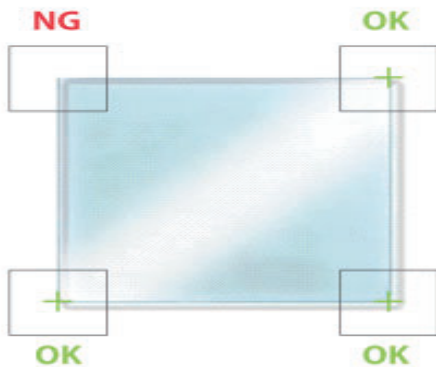

Precautions for Correct Use

When the *Manual Position Setting* processing unit is set in the measurement flow, *Measurement initialization priority* in the startup setting performs an operation as the *Processing of redrawing on screen priority* is set up.

4-32-1 Settings Flow (Manual Position Setting)

To set Manual Position Setting, follow the steps below.

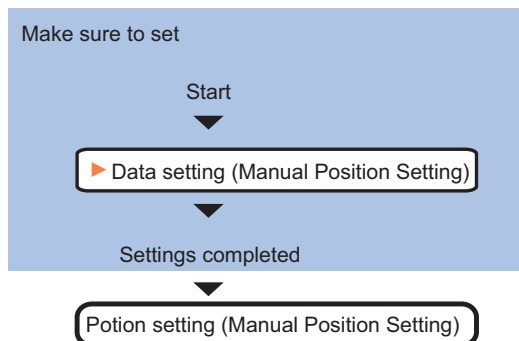

List of Manual Position Setting Items

Data setting screen

Item	Description
Data setting	Sets the target data for the Position Setting . <i>4-32-2 Data Setting (Manual Position Setting)</i> on page 4-236
Position setting	In the Manual Position Setting screen, Manually specifies measured coordinates failed in measurement. <i>4-32-3 Position Setting (Manual Position Setting)</i> on page 4-242

How to use the Manual Position Setting

The **Manual Position Setting** can be utilized in the following two ways.

● Example of Measurement Flow in "Communication Command Startup" (When Displaying the Manual Position Setting Screen by Remeasurement):

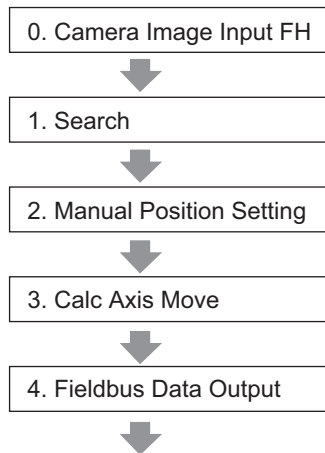

When the measurement is NG, the "Position setting request flag" becomes "1".

After the end of the measurement, the "Manual Position Setting" screen will be displayed by executing the measurement flow again with a command from the PLC.

- 1** Place this processing unit just after an inspection or measurement processing unit such as **Search**. If there are multiple processing units in the measurement flow, place this just after the last one.

Set the **How to open position setting screen** of the **Data Setting** to *With re-measurement*.
 4-32-2 *Data Setting (Manual Position Setting)* on page 4-236
- 2** After processing a series of measurement flow, a processing unit such as **Fieldbus Data Output** transmits measurement data to an upper device such as a PLC.

The upper device such as a PLC checks the received measurement data. If the **Position setting request flag** was set **1**, the upper device judges that the position setting is required again due to failure in the measurement for alignment marks.
- 3** If the **Position setting request flag** is **1**, the upper device transmits a measurement command to perform the measurement again.

Display the **Manual Position Setting** Screen.
 4-32-3 *Position Setting (Manual Position Setting)* on page 4-242
- 4** Manually specify the alignment mark positions failed to measure on the **Manual Position Setting** screen displayed.

Sets the coordinates specify on the **Manual Position Setting** screen as the measurement coordinates. Sets the **Position setting request flag** from **1** to **0** and sets the **Position setting complete flag** from **0** to **1**.
- 5** A processing unit such as **Calc Axis Move** recalculates the movement amount based on the corrected measurement coordinates. A processing unit such as **Fieldbus Data Output** transmits the measurement data to the upper device.

● **Example of Measurement Flow in "Auto Startup during Measurement" (When Displaying the Manual Position Setting Screen while Performing a Measurement Flow):**

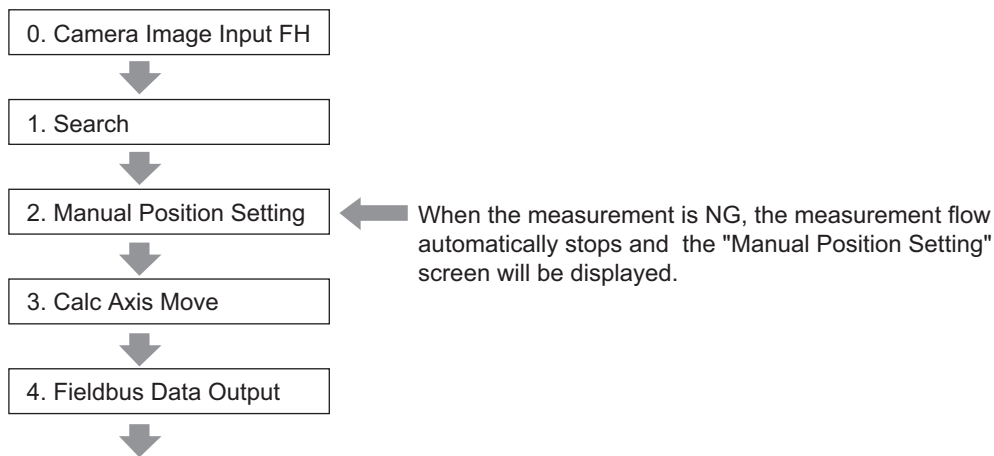

- 1** Place this processing unit just after an inspection or measurement processing unit such as **Search**. If there are multiple processing units in the measurement flow, place this just after the last one.
Set the **How to open position setting screen** of the **Data Setting** to *No re-measurement*.
4-32-2 *Data Setting (Manual Position Setting)* on page 4-236
- 2** When any inspection or measurement processing unit placed prior to this processing unit failed in measurement such as alignment marks, this processing unit halts the processing flow and displays the **Manual Position Setting** screen.
Sets the **Position setting request flag** from 0 to 1.
4-32-3 *Position Setting (Manual Position Setting)* on page 4-242
- 3** Manually specify the alignment mark positions failed to measure on the **Manual Position Setting** screen displayed.
Sets the coordinates specify on the **Manual Position Setting** screen as the measurement coordinates. Sets the **Position setting request flag** from 1 to 0 and sets the **Position setting complete flag** from 0 to 1.
- 4** The processing flow is automatically restarted after the setting.

4-32-2 Data Setting (Manual Position Setting)

Here register coordinates for a processing item such as **Search** specified in the *Inspection and Measurement*. If a failure occurred in measurement, the model registered here is superimposed on the measurement image in the *Manual Position Setting* screen.

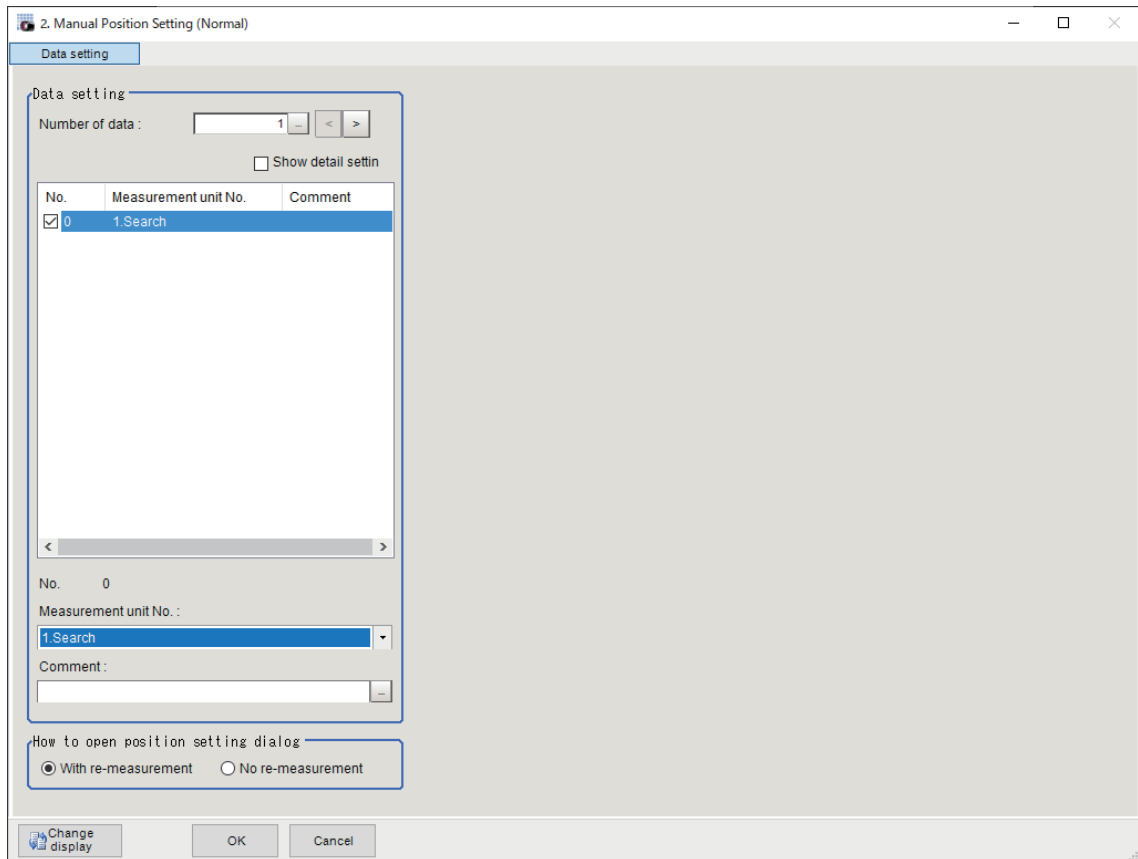

Setting item	Setting value [Factory default]	Description
Number of data	1 to 100 [1]	Sets the number of target data for the <i>Manual Position Setting</i> .
Show detail setting	<ul style="list-style-type: none"> • Checked • [Unchecked] 	Switches the detail and simplified settings. <ul style="list-style-type: none"> • Checked: Displays the detail setting screen. <i>4-32-2 Data Setting (Manual Position Setting)</i> on page 4-236 • Unchecked: Switches to the simplified screen.
Data list area	<ul style="list-style-type: none"> • [Checked] • Unchecked 	Displays target data for the Position Setting . Displays the data of the set number of Number of data . Checked data is the valid target data.
No.	-	Displays the data number of the selection items in the data list area.
Measurement unit No.	Reference unit number [<None>]	Sets the measurement unit of the selection items in the data list area. Inspection and measurement processing units must be located prior to this processing unit. If not, nothing will be displayed.
Comment	0 to 1,000 characters	Sets the comments. Multilingual is also supported. For details, refer to <i>Inputting Text</i> in the <i>Vision System FH/FHV Series User's Manual (Cat. No. Z365)</i> .

Setting item	Setting value [Factory default]	Description
How to open position setting screen	<ul style="list-style-type: none"> [With re-measurement] No re-measurement 	<p>Set how to display the Manual Position Setting screen.</p> <ul style="list-style-type: none"> With re-measurement: After conditions set at the Data setting area were mismatched, the Manual Position Setting screen will be displayed by performing the measurement flow again. No re-measurement: The Manual Position Setting screen is automatically popped up when conditions set at the Data setting area were mismatched. The measurement is suspended while displaying the Manual Position Setting screen. The measurement is restarted after the Manual Position Setting screen is closed.

*1. Screen when **Show detail setting** is checked:

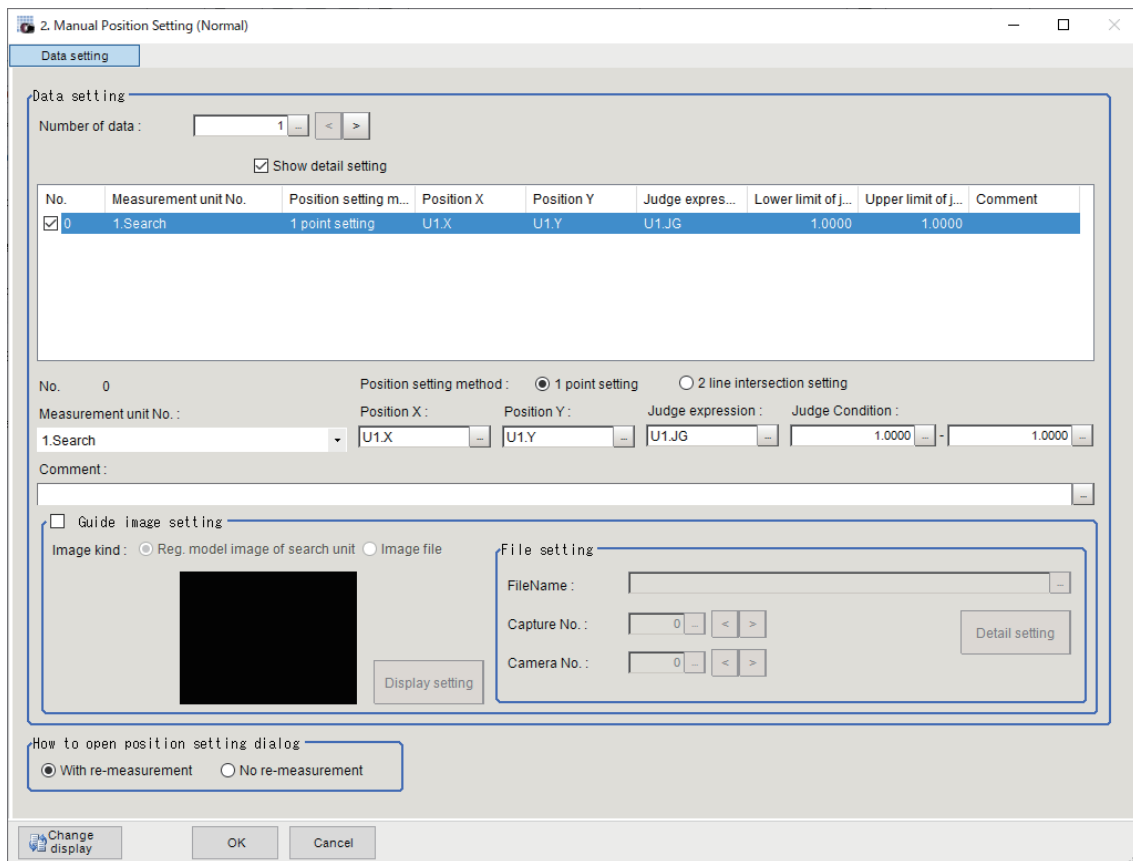

Setting item	Setting value [Factory default]	Description
Number of data	1 to 100 [1]	Sets the number of target data for the <i>Manual Position Setting</i> .
Show detail setting	<ul style="list-style-type: none"> Checked [Unchecked] 	<ul style="list-style-type: none"> Checked: Displays the detail setting screen. Unchecked: Switches to the simplified screen.
Data list area	<ul style="list-style-type: none"> [Checked] Unchecked 	<p>Displays target data for the Position Setting.</p> <p>Displays the data of the set number of Number of data. Checked data is the valid target data.</p>
No.	-	Displays the data number of the selection items in the data list area.

Setting item	Setting value [Factory default]	Description
Measurement unit No.	Reference unit number [<None>]	Sets the measurement unit of the selection items in the data list area. Inspection and measurement processing units must be located prior to this processing unit. If not, nothing will be displayed.
Position setting method	<ul style="list-style-type: none"> [1 point setting] [2 line intersection setting] 	Sets how to set the Position Setting .
Position X	-	Sets the calculation expression of the measurement position X becoming basic data for settings.
Position Y	-	Sets the calculation expression of the measurement position Y becoming basic data for settings.
Judge expression	-	Sets the judgment expression for NG judgment.
Judge condition	-99,999.9999 to 99,999.9999 [-1.0000] to [1.0000]	Sets the range to judge the judgment expression result.
Comment	0 to 1,000 characters	Sets the comments. Multilingual is also supported. For details, refer to <i>Inputting Text</i> in the <i>Vision System FH/FHV Series User's Manual (Cat. No. Z365)</i> .
Guide image setting	<ul style="list-style-type: none"> [Checked] [Unchecked] 	Sets whether or not to display a guide image in the Position setting . If checked, the settings in the Guide image setting area will be enabled.
Image kind	<ul style="list-style-type: none"> [Reg. model image of search unit] [Image file] 	Sets an overlapped image.
Display setting	-	If clicked, the Display setting screen will be displayed. For details, refer to <i>Display Setting</i> on page 4-240.
File setting	-	Sets the image file used for the guide image display. These settings are enabled when <i>Image file</i> is selected in the Image kind .
File name	-	Sets the file name.
Capture No.	0 to 9,999 [0]	Sets the capture number of an image to be overlapped on a displayed image when the file selected in the File name is ifz, bfz, or jfz.
Camera No.	0 to 15 [0]	Sets the camera number of an image to be overlapped on a displayed image when the file selected in the File name is ifz, bfz, or jfz.
Detail setting	-	The <i>Detail setting</i> screen will be displayed. For details, refer to <i>Detail Setting</i> on page 4-241.

Setting item	Setting value [Factory default]	Description
How to open position setting screen	<ul style="list-style-type: none"> [With re-measurement] No re-measurement 	<p>Set how to display the Manual Position Setting screen.</p> <ul style="list-style-type: none"> With re-measurement: After conditions set at the Data setting area were mismatched, the Manual Position Setting screen will be displayed by performing the measurement flow again. No re-measurement: The Manual Position Setting screen is automatically popped up when conditions set at the Data setting area were mismatched. The measurement is suspended while displaying the Manual Position Setting screen. The measurement is restarted after the Manual Position Setting screen is closed.

Display Setting

Here performs display settings for the guide image. Values set here are used as default in the **Manual Position setting** screen. This screen will be displayed when *Reg. model image of search unit* is set on the **Image kind** in the **Guide image setting** and click the **Display setting** button.

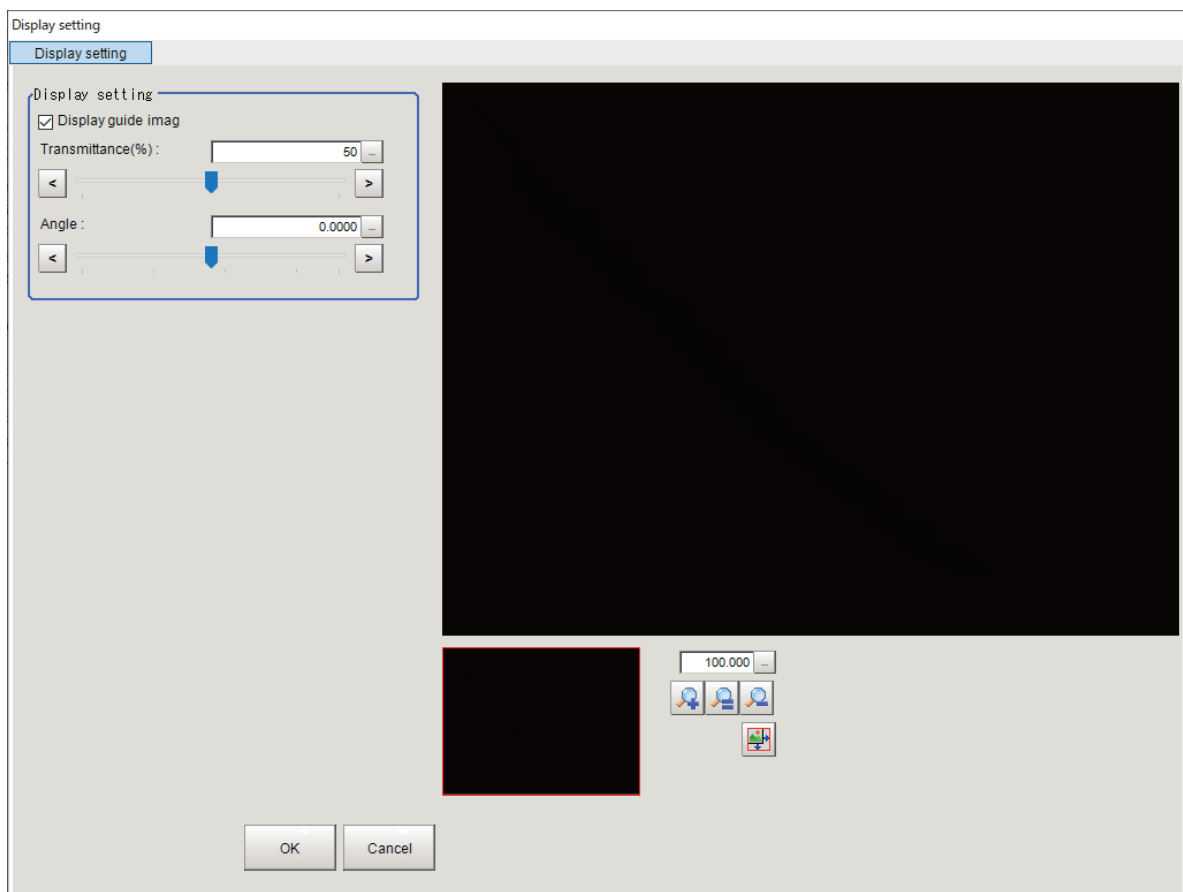

Setting item	Setting value [Factory default]	Description
Display setting	-	<p>Sets how to display a guide image.</p> <p>Values set here will be the default for the Manual Position setting screen.</p>

Setting item	Setting value [Factory default]	Description
Display guide image	<ul style="list-style-type: none"> [Checked] Unchecked 	Sets whether or not to display the guide image.
Transmittance [%]	0 to 100 [50]	Sets the transmittance rate for the guide image. As close to 100%, the guide image becomes transparent.
Angle	-180.0000 to 180.0000 [0.0000]	Sets the rotation angle for the guide image. The image rotates around the detection point coordinates.

Detail Setting

Here performs display settings for the file image of the guide image. This screen will be displayed when *Image file* is set on the **Image kind** in the **Guide image setting** and click the **Detail setting** button.

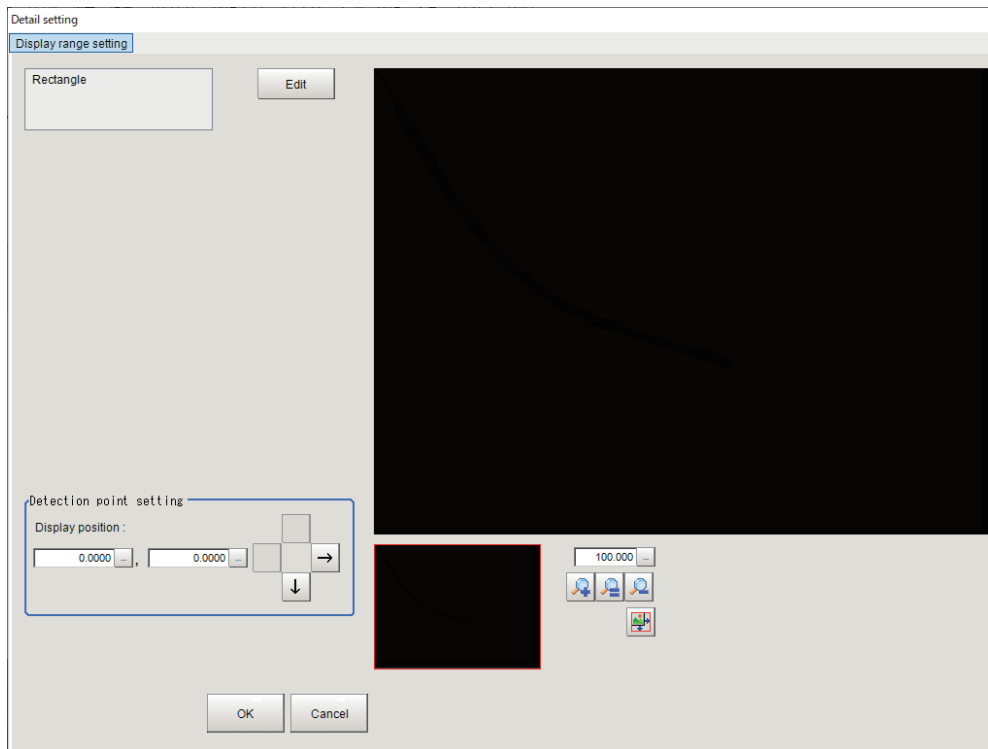

Setting item	Setting value [Factory default]	Description
Registered figure	[Full screen]	Sets the display range for the guide image. The figure is fixed to Rectangle.
Detection point setting	-	Sets the display position for the guide image.
Display position	X: 0.0000 to 99,999.0000 [0.0000] Y: 0.0000 to 99,999.0000 [0.0000]	

4-32-3 Position Setting (Manual Position Setting)

This screen is displayed when the measurement of the measurement unit set in the data settings fails. Select the target data from the list and set the coordinates.

This screen is displayed when a measurement processing unit set in the **Data Setting** is failed to measure such as alignment marks while this processing unit is launched. Select target data from the list to perform the position setting.

● 1 Point Setting

Specify positions manually.

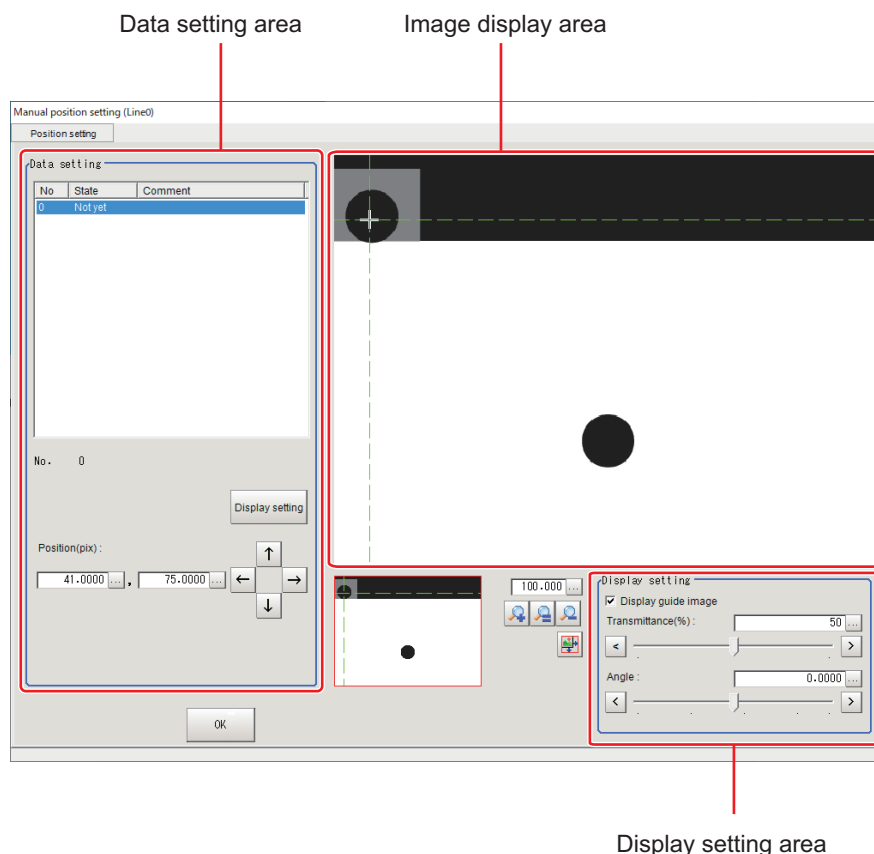
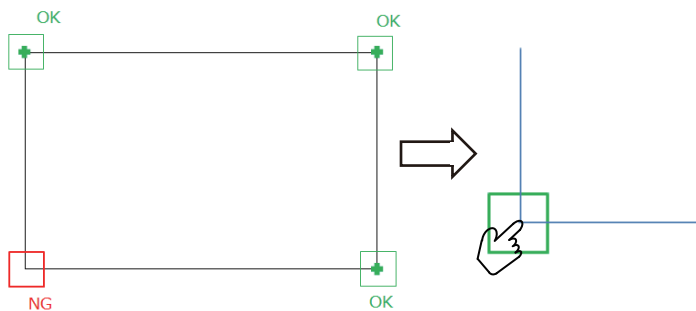

- 1 The failed measurement points are displayed in the **Data setting** area as *Not yet*. Click an item to set from the list.
When the **Display guide image** is selected, the guide image such as an alignment mark is overlapped on the displayed image in the Image display area.

- 2 When the position is correct, click the intersection on the display or input numerical values to set the position. If not correct, then click a correct position on the display or input numerical values to set it.
- 3 Repeat the above steps until all *Not yet* items in the **Data setting** area become *Done*.
- 4 Click **OK** when all items become *Done*.
The **Manual position setting** screen is closed and the measurement processing is restarted.

Setting item	Setting value [Factory default]	Description
Data setting	-	-
Setting data list	-	Displays the No. , State and Comment of the target data for the Manual position setting. When you set the position of the target data, the State changes from <i>Not yet</i> to <i>Done</i> .
No.	-	Displays the data number of the selection items in the data list.
Display setting	R: 0 to 255 [0] G: 0 to 255 [255] B: 0 to 255 [0] Line width [pix.]: 1 to 10 [1]	Displays the 2 line common settings screen when clicking this. Sets the color and width of dotted lines indicating the X and Y positions to be set. *1
Position [pix.]	0.0000 to 99,999.9999	Sets the X and Y positions of the selected target data No.. Unit: pixel
Display setting	-	-
Display guide image	<ul style="list-style-type: none"> • Checked • [Unchecked] 	Sets whether or not to display a guide image to be overlapped on the displayed image. Unchecked: The guide image is not displayed.
Transmittance [%]	0 to 100 [50]	Sets the transmittance rate for the guide image. As close to 100%, the guide image becomes transparent.
Angle	-180.000 to 180.000 [0]	Sets the rotation angle for the guide image. The image rotates around the detection point coordinates.

*1. 2 line common settings:

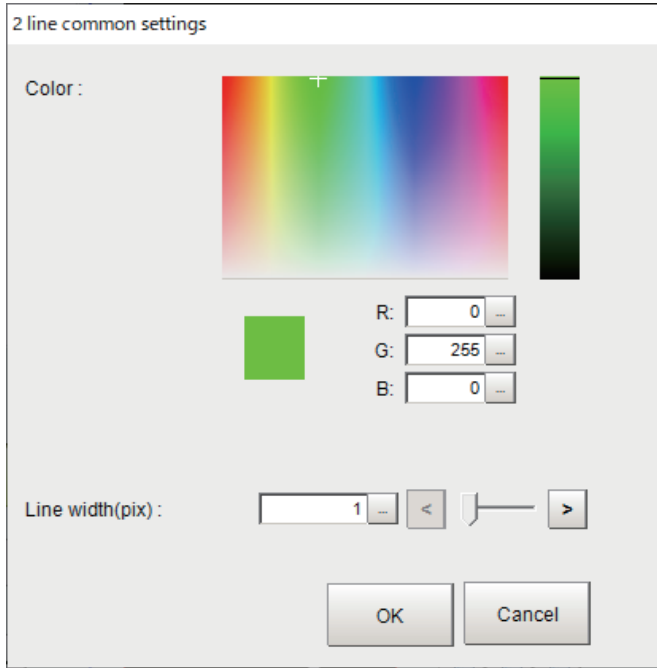

● **2 line Intersection setting**

Specify two lines manually and specify the created intersection.

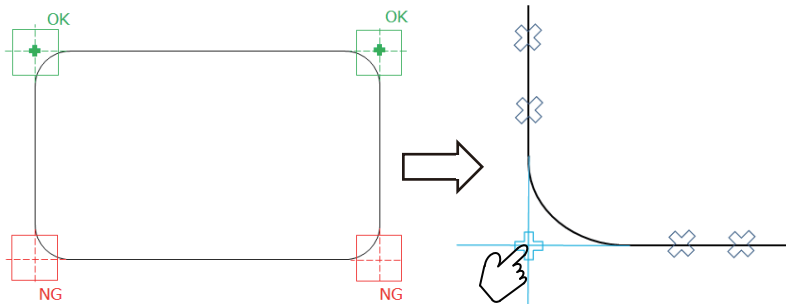

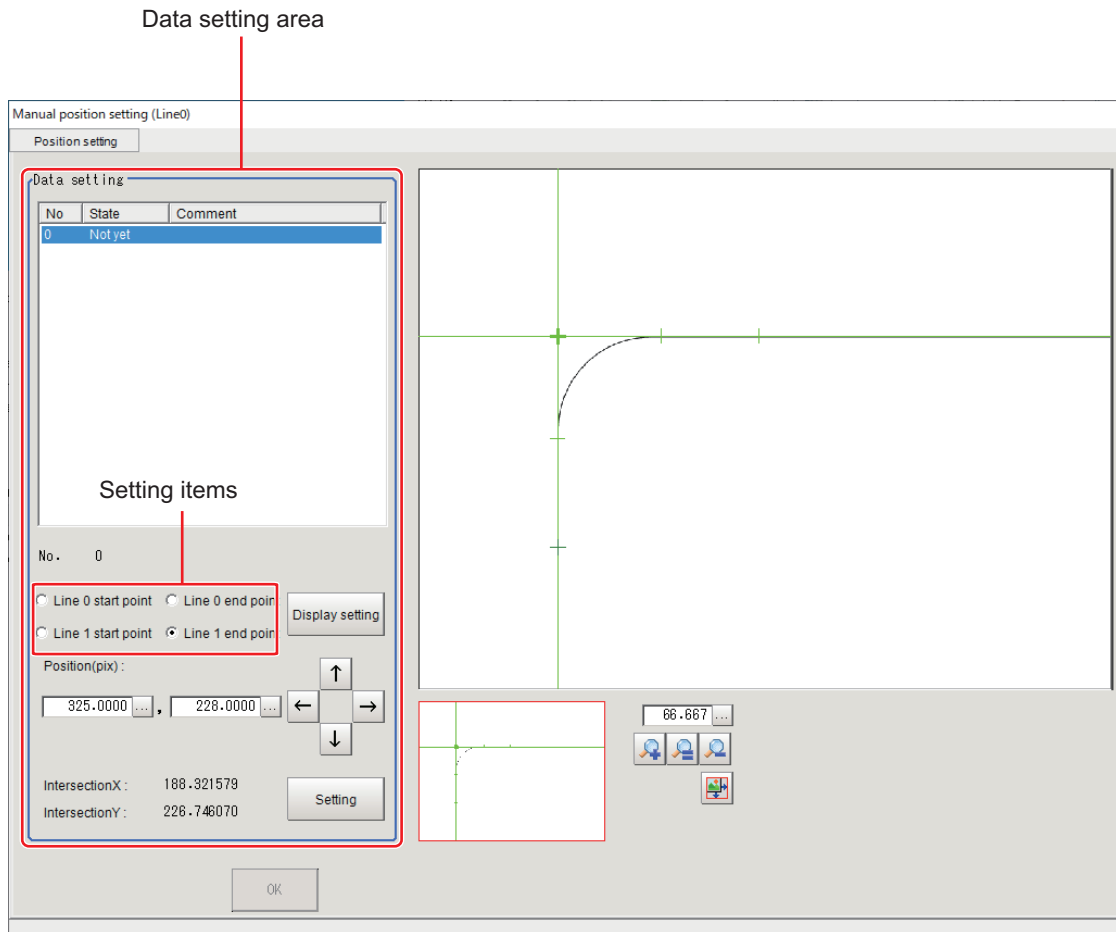

- 1 The failed measurement points are displayed in the **Data setting** area as *Not yet*. Click an item to set from the list.
When the **Display guide image** is selected, the guide image such as an alignment mark is overlapped on the displayed image in the Image display area.
- 2 Click the **Line 0 start point** to set the start point of line 0. Click the **Line 0 end point** to set the line 0 end point. Click coordinate positions on the display or input numerical values to set them.
- 3 Click the **Line 1 start point** to set the start point of line 1. Click the **Line 1 end point** to set the line 1 end point. Click coordinate positions on the display or input numerical values to set them.
- 4 Click the **Setting** button and set the intersection coordinates of the set two straight lines as the set positions.
- 5 Click two points on each line of the measurement target to display the intersection position. Click the intersection on the display or input numerical values to set the position.
- 6 Repeat the above steps until all *Not yet* items in the **Data setting** area become *Done*.
- 7 Click **OK** when all items become *Done*.
The **Manual position setting** screen is closed and the measurement processing is restarted.

Setting item	Setting value [Factory default]	Description
Data setting	-	-
Setting data list	-	Displays the No. , State and Comment of the target data for the Manual position setting. When you set the position of the target data, the State changes from <i>Not yet</i> to <i>Done</i> .
No.	-	Displays the data number of the selection items in the data list.
Line 0 start point	-	Specifies the start and end points for line 0 and 1 to set each line.
Line 0 end point	-	
Line 1 start point	-	
Line 1 end point	-	
Display setting	R: 0 to 255 [0] G: 0 to 255 [255] B: 0 to 255 [0] Line width [pix.]: 1 to 10 [1]	
Position [pix.]	0.0000 to 99,999.9999	Sets the each X and Y positions of the Line 0 start point , Line 0 end point , Line 1 start point and Line 1 end point of the selected target data No. Unit: pix
Intersection X	-	Displays the intersection position for two lines.
Intersection Y	-	
Setting	-	Clicking this button updates the current intersection as the setting position.

*1. 2 line common settings:

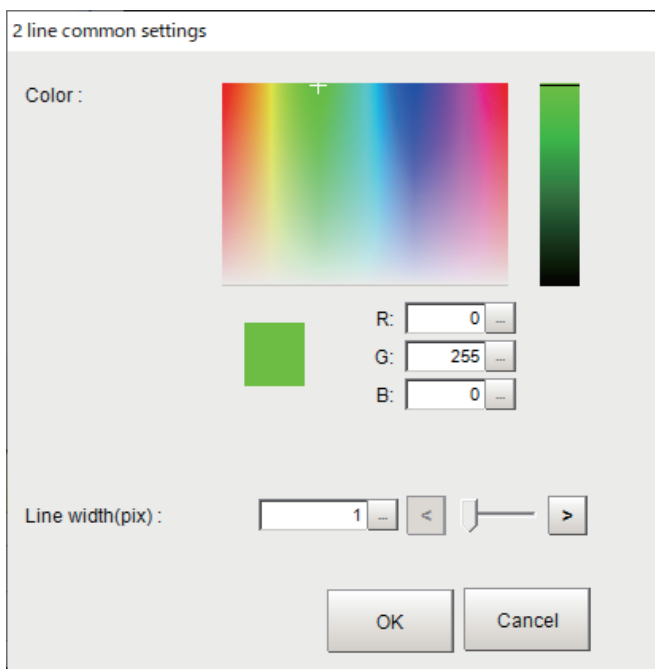

4-32-4 Measurement Results for Which Output Is Possible (Manual Position Setting)

The following values can be output using processing items related to result output. It is also possible to reference measurement values from calculation expressions and other processing units.

Measurement items	Character string	Description
Judge	JG	Judgment result 0: No judgment (unmeasured) 1: Judgment result OK -1: Judgment result NG -10: Error (image format mismatch) -11: Error (unregistered model) -12: Error (insufficient memory) -20: Error (other errors)
Position setting request flag	SRF	0: Not need position setting 1: Need position setting
Position setting complete flag	SCF	0: Not yet position setting 1: Position setting is completed
Position	X00 to X99, Y00 to Y99	Position X and Position Y When <i>2 line intersection setting</i> is set, the intersection X and Y

4-32-5 External Reference Tables (Manual Position Setting)

No.	Data name	Data ident	Set/Get	Data range
0	Judge	judge	Get only	0: No judgment (unmeasured), 1: Judgment result OK, -1: Judgment result NG
5	Position setting request flag	settingRequiredFlag	Get only	0: Not need position setting 1: Need position setting
6	Position setting complete flag	settingCompletedFlag	Get only	0: Not yet position setting 1: Position setting is completed
120	Number of data	dataNum	Set/Get	1 to 100
121	How to open position setting dialog	displayKind	Set/Get	0: With re-measurement 1: No re-measurement
200	Show detail setting	detailSetting	Set/Get	0: OFF, 1: ON
1,001+N×100 (N=0 to 99)	Position X	positionX00 to positionX99	Get only	Position X When <i>2 line intersection setting</i> is set, the intersection X
1,002+N×100 (N=0 to 99)	Position Y	positionY00 to positionY99	Get only	Position Y When <i>2 line intersection setting</i> is set, the intersection Y
1,010+N×100 (N=0 to 99)	Setting ON/OFF	enableFlag00 to enableFlag99	Set/Get	0: OFF, 1: ON
1,011+N×100 (N=0 to 99)	Measurement unit No.	measurementUnitNo00 to measurementUnitNo99	Set/Get	-1: No reference 0 to 9,999: Measurement unit referred

No.	Data name	Data ident	Set/Get	Data range
1,012+N×100 (N=0 to 99)	Position X	expPositionX00 to expPositionX99	Set/Get	Exp. Character string
1,013+N×100 (N=0 to 99)	Position Y	expPositionY00 to expPositionY99	Set/Get	Exp. Character string
1,014+N×100 (N=0 to 99)	Judge expression	expJudge00 to expJudge99	Set/Get	Exp. Character string
1,015+N×100 (N=0 to 99)	Upper limit of judgement	upperJudge00 to upperJudge99	Set/Get	-999,999,999.9999 to 999,999,999.9999
1,016+N×100 (N=0 to 99)	Lower limit of judgement	lowerJudge00 to lowerJudge99	Set/Get	-999,999,999.9999 to 999,999,999.9999
1,017+N×100 (N=0 to 99)	Comment	comment00 to comment99	Set/Get	Character string
1,018+N×100 (N=0 to 99)	Position setting method	posSettingType00 to posSettingType99	Set/Get	0: One point setting 1: Two line intersection setting
1,019+N×100 (N=0 to 99)	Guide image Setting	imageGuideSetting00 to imageGuideSetting99	Set/Get	0: OFF, 1: ON
1,020+N×100 (N=0 to 99)	Guide image kind	imageGuideSettingType00 to imageGuideSettingType99	Set/Get	0: Reg. model image of search unit, 1: Image file
1,021+N×100 (N=0 to 99)	Image file path	imageFilePath00 to imageFilePath99	Set/Get	Character string
1,022+N×100 (N=0 to 99)	Capture No.	captureNo00 to captureNo99	Set/Get	0 to 9,999
1,023+N×100 (N=0 to 99)	Camera No.	cameraNo00 to cameraNo99	Set/Get	0 to 15
1,024+N×100 (N=0 to 99)	Detection point X	detectionPosX00 to detectionPosX99	Set/Get	0 to 99,999.9999
1,025+N×100 (N=0 to 99)	Detection point Y	detectionPosY00 to detectionPosY99	Set/Get	0 to 99,999.9999
1,026+N×100 (N=0 to 99)	Display guide image	imageGuideDisplay00 to imageGuideDisplay99	Set/Get	0: OFF, 1: ON
1,027+N×100 (N=0 to 99)	Transmittance(%)	transmittance00 to transmittance99	Set/Get	0 to 100
1,028+N×100 (N=0 to 99)	Angle	angle00 to angle99	Set/Get	-180 to 180
1,029+N×100 (N=0 to 99)	Graphic color R	colorR00 to colorR99	Set/Get	0 to 255
1,030+N×100 (N=0 to 99)	Graphic color G	colorG00 to colorG99	Set/Get	0 to 255
1,031+N×100 (N=0 to 99)	Graphic color B	colorB00 to colorB99	Set/Get	0 to 255
1,032+N×100 (N=0 to 99)	Graphic width	lineWidth00 to lineWidth99	Set/Get	1 to 10

4-33 Camera Calibration

Setting the camera calibration enables to convert the measurement results to the actual dimensions for output. This processing item provides more flexible adjustment and editing utilizing the measurement flow compared to the built-in calibration function in Input Image processing items.

- The sampling function can be used by combining with measurement processing units in the measurement flow.
- A scale can be calculated from measured workpiece width and the actual workpiece width.
- The created calibration data can be adjusted or edited.

Used in the Following Case

When outputting the measurement result from a processing unit as actual dimensions

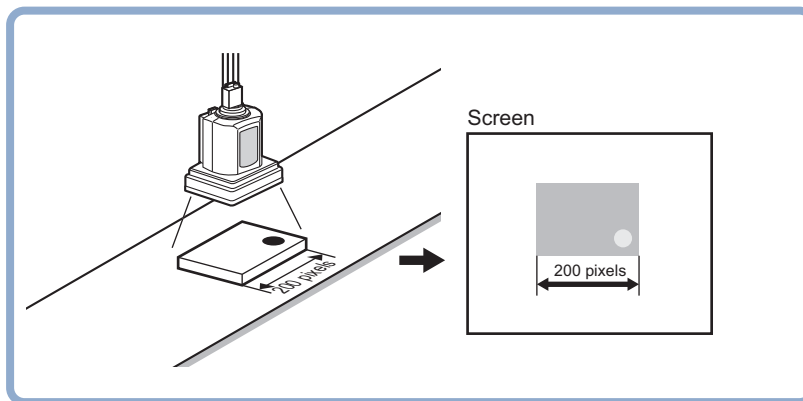

Precautions for Correct Use

In the measurement flow, if the processing unit that generates the calibration data is set after the processing unit that corrects the image, the output coordinates that can be acquired by the processing unit after the processing unit that generates the calibration data are only the coordinates after image correction.

4-33-1 Settings Flow (Camera Calibration)

To set Camera Calibration, follow the steps below.

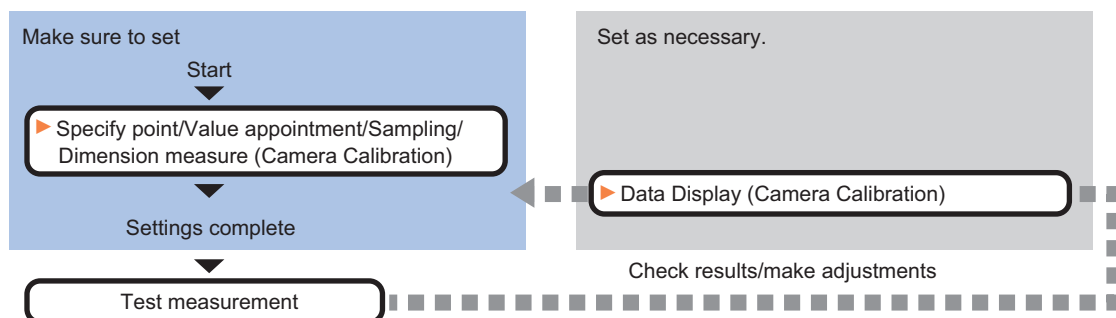

List of Camera Calibration Items

Item	Description
Specify point	Sets an arbitrary pixel to make the calibration setting. Calibration parameters are automatically calculated when actual coordinates of specified locations are set. <i>4-33-2 Specify Point (Camera Calibration) on page 4-250</i>
Value appointment	Sets the magnification ratio by specifying a numeric value directly to make the calibration setting. <i>4-33-3 Value Appointment (Camera Calibration) on page 4-251</i>
Sampling	Performs the calibration setting based on the measurement results. After measuring a position using the measurement processing units in the measurement flow, calibration data can be calculated by setting the actual coordinates of the position. <i>4-33-4 Sampling (Camera Calibration) on page 4-253</i>
Dimension measure	Performs the calibration setting based on the measurement results. After measuring a workpiece width, calibration data can be calculated by setting the actual workpiece width. <i>4-33-5 Dimension Measure (Camera Calibration) on page 4-255</i>
Data display	Displays the generated calibration data. The calibration data can be adjusted or edited as necessary. <i>4-33-6 Data Display (Camera Calibration) on page 4-258</i>

4-33-2 Specify Point (Camera Calibration)

Specify an arbitrary pixel to perform the calibration setting. Calibration parameters can be generated by setting the actual coordinates of specified locations. Up to 100 points can be set.

- 1 In the Item tab area, click **Specify point**.

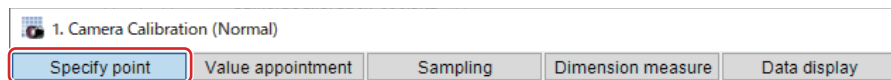

- 2 In the *Display* area, click **Change display** to select the type of camera images.

Setting item	Setting value [Factory default]	Description
Display	<ul style="list-style-type: none"> • Through image • [Freeze image] 	<ul style="list-style-type: none"> • Through image: The latest image is always loaded from the camera and displayed. • Freeze image: The image loaded in the immediately preceding measurement is displayed.

- 3 Click the first point on the screen.
- 4 Set the actual coordinates for the specified point.
The *Coordinate setting input* window is displayed.

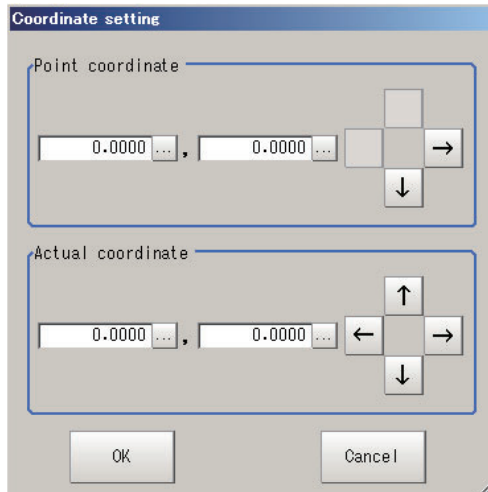

Setting item	Setting value [Factory default]	Description
Point coordinate X, Y	0 to 9,999.9999 [Clicked point on the window]	-
Actual coordinate X, Y	-99,999.9999 to 99,999.9999 [0]	-

5 Set the 2nd, 3rd, and subsequent points in the same way.

6 Edit or delete the coordinates as necessary.
Select the point to edit or delete on the list.
Click **Edit** or **Delete**.
To delete all points, click **Clear All**.

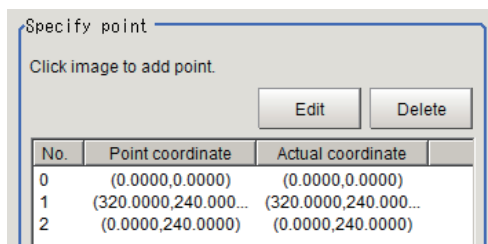

7 Click **Generate calibration parameters**.
The calibration parameters will be generated.

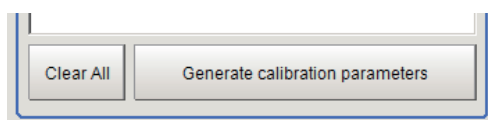

4-33-3 Value Appointment (Camera Calibration)

Set the magnification by directly specifying a numerical value to set the calibration setting.

1 In the Item tab area, click **Value appointment**.

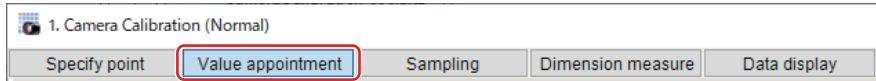

2 Set the *Value appointment* area.

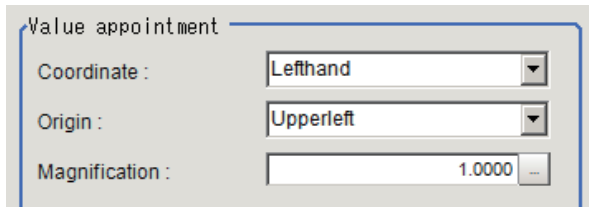

Setting item	Setting value [Factory default]	Description
Coordinate	<ul style="list-style-type: none"> [Lefthand] Righthand 	<ul style="list-style-type: none"> Lefthand The clockwise is forward when setting the coordinates. Righthand The counter-clockwise is forward when setting the coordinates.
Origin	<ul style="list-style-type: none"> [Upperleft] Lowerleft Center Specify point 	<p>Sets the origin of the actual coordinates.</p>
Magnification	0.0001 to 9.9999 [1.0000]	Specifies the ratio of one pixel to the actual dimensions.

- When *Specify point* is selected in *Origin*:

Setting item	Setting value [Factory default]	Description
Camera X and Y	-99,999.9999 to 99,999.9999 [0]	Sets the camera coordinates for an arbitrary point. When the origin in the actual coordinates is included in the field of view, measure the origin position in the actual coordinates beforehand and set them to the camera coordinates X and Y.
Changed X and Y	-99,999.9999 to 99,999.9999 [0]	Sets the coordinate values for the actual coordinates set in the camera coordinates. If the origin position in the actual coordinates is set to the camera coordinates, set (0.0, 0.0).

- 3 Click **Generate calibration parameters**.
The calibration parameters will be generated.

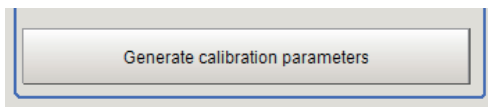

4-33-4 Sampling (Camera Calibration)

Performs the calibration setting based on the measurement results. After measuring a position using measurement processing items in the measurement flow, set the actual coordinates for the position to calculate calibration data.

- 1 In the Item Tab area, click **Sampling**.

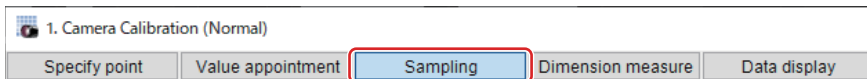

- 2 Set *Sampling* area.

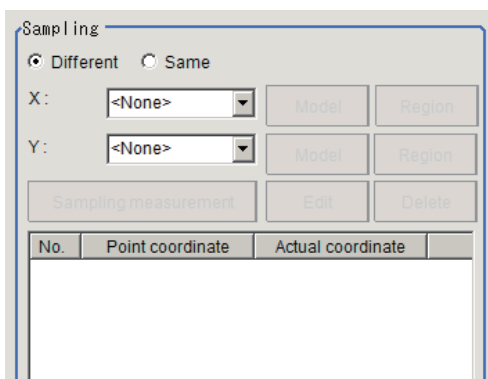

Setting item	Setting value [Factory default]	Description
XY specification method	<ul style="list-style-type: none"> [Different] Same 	<ul style="list-style-type: none"> Different: Sets X and Y individually. Same: Uses the measurement results of the processing unit selected for X specification to specify Y.

Setting item	Setting value [Factory default]	Description
X specification	<ul style="list-style-type: none"> Processing unit that can measure positions in the measurement flow [None] 	Selects the processing unit in the measurement flow used to sample the X coordinate
Y specification	<ul style="list-style-type: none"> Processing unit that can measure positions in the measurement flow [None] 	Selects the processing unit in the measurement flow used to sample the Y coordinate If <i>Same</i> is specified in the <i>XY specification method</i> , this cannot be selected.

- 3 Click **Model** or **Region** to set sampling measurement conditions, as necessary.
- 4 Click **Sampling measurement**.
- 5 Set the actual coordinates for the specified point.
The *Actual coordinate input* window is displayed.

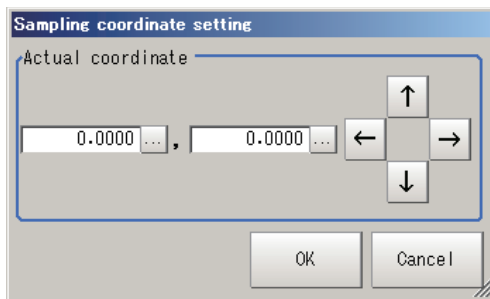

Setting item	Setting value [Factory default]	Description
Actual coordinate X, Y	-99,999.9999 to 99,999.9999 [0]	-

- 6 Set the 2nd, 3rd, and subsequent points in the same way.
- 7 Edit or delete the coordinates as necessary.
Select the point to edit or delete on the list.
Click **Edit** or **Delete**.
To delete all points, click **Clear All**.

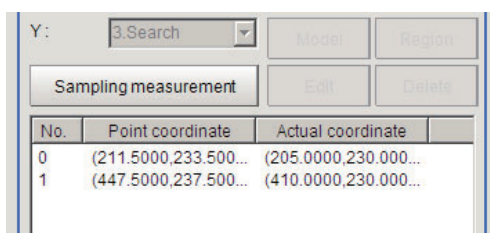

- 8** Click **Generate calibration parameters**.
The calibration parameters will be generated.

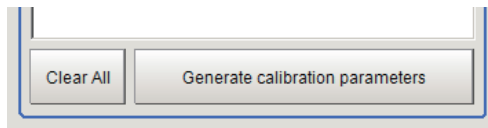

- 9** Changes the *Display setting* as necessary.

Setting item	Setting value [Factory default]	Description
Display setting	<ul style="list-style-type: none"> • [Input image] • X unit image • Y unit image 	Selects the type of image to display in the <i>Image display</i> area. The <i>Display setting</i> is valid only in the Sampling tab screen.



Additional Information

The following processing items are available for "2 points measurement" in the "Sampling".

- Search
- Search II
- EC Circle Search
- ECM Search
- EC Corner
- EC Cross
- Shape Search II
- Shape Search III
- Edge Position
- Scan Edge Position
- Gravity and Area
- Labeling

4-33-5 Dimension Measure (Camera Calibration)

Set the calibration based on the measurement results. After measuring a workpiece width using the measurement processing items in the measurement flow, set the actual workpiece width to calculate calibration data.

- 1** In the Item tab area, click **Dimension measure**.

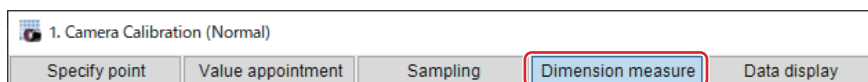

- 2** In the *Dimension measure* area, set each item.

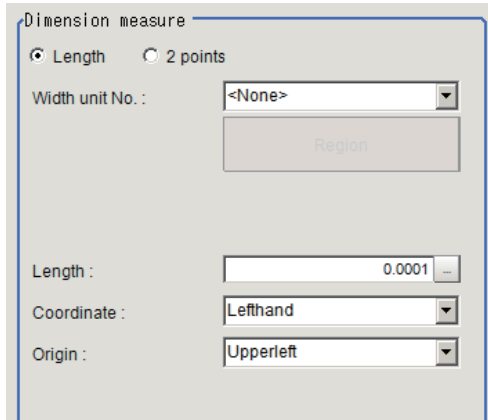

Setting item	Setting value [Factory default]	Description
dimension measure	<ul style="list-style-type: none"> [Length] 2 points 	<ul style="list-style-type: none"> Length: Measures dimensions using the measurement results of the processing unit measuring the width. The <i>Width unit No.</i> for the reference processing unit selection and Region button are displayed. 2 points: Measures dimensions using the measurement results of the processing unit measuring points. The <i>Point 1 unit No.</i> and <i>Point 2 unit No.</i> for the reference processing unit selection and Model and Region buttons are displayed.
Length	0.0001 to 99,999.9999 [0.0001]	Sets the workpiece dimensions in real dimensions.
Coordinate	<ul style="list-style-type: none"> [Lefthand] Righthand 	<ul style="list-style-type: none"> Lefthand The clockwise is forward when setting the coordinates. Righthand The counter-clockwise is forward when setting the coordinates. <div style="text-align: center;"> <p>Lefthanded</p> <p>Righthanded</p> </div>

Setting item	Setting value [Factory default]	Description
Origin	<ul style="list-style-type: none"> • [Upperleft] • Lowerleft • Center • Specify point 	Sets the origin of the actual coordinates.

- When *Length* is selected in the *Dimension measure*:

Setting item	Setting value [Factory default]	Description
Width unit No.	<ul style="list-style-type: none"> • width reference unit in the measurement flow • [<None>] 	Selects the <i>Scan Edge Width</i> processing unit in the current scene.

- When *2 points* is selected in the **Dimension measure**:

Setting item	Setting value [Factory default]	Description
Point 1 and 2 unit No.	<ul style="list-style-type: none"> • Point width measurement unit in the measurement flow • [<None>] 	Selects the processing unit that can measure points in the current scene.

- When *Specify point* is selected in the **Origin**:

Setting item	Setting value [Factory default]	Description
Camera X and Y	-99,999.9999 to 99,999.9999 [0]	Sets the camera coordinates for an arbitrary point. When the origin in the actual coordinates is included in the field of view, measure the origin position in the actual coordinates beforehand and set them to the camera coordinates X and Y.
Changed X and Y	-99,999.9999 to 99,999.9999 [0]	Sets the coordinate values for the actual coordinates set in the camera coordinates. If the origin position in the actual coordinates is set to the camera coordinates, set (0.0, 0.0).

3 Click **Region** as necessary to set sampling measurement conditions.

4 Click **Sampling measurement**.

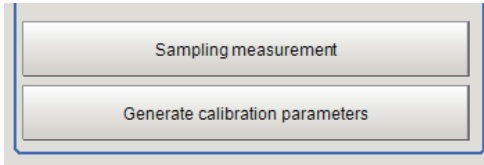

- 5** Click **Generate calibration parameters**.
The calibration parameters will be generated.

- 6** Change the *Display setting* as necessary.
- When *Length* is selected:

Setting item	Setting value [Factory default]	Description
Display setting	<ul style="list-style-type: none"> [Input image] Width unit image 	Selects the type of image to display in the <i>Image display</i> area. The <i>Display setting</i> is valid only in Dimension measure tab screen.

- When *2 points* is selected:

Setting item	Setting value [Factory default]	Description
Display setting	<ul style="list-style-type: none"> [Input image] Point 1 unit image Point 2 unit image 	Selects the type of image to display in the <i>Image display</i> area. The <i>Display setting</i> is valid only in Dimension measure tab screen.



Additional Information

The following processing items are available for "2 points measurement" in the "Dimension Measure".

- Search
- EC Circle Search
- ECM Search
- EC Corner
- EC Cross
- Shape Search II
- Shape Search III
- Edge Position
- Scan Edge Position
- Gravity and Area
- Labeling

4-33-6 Data Display (Camera Calibration)

Display the generated calibration data. The calibration data can be adjusted or edited as necessary.

- 1** In the Item tab area, click **Data display**.



2 In the *Calibration data* area, check the calibration data.

Calibration data			
A :	1.000000	D :	0.000000
B :	0.000000	E :	1.000000
C :	0.000000	F :	0.000000
X magnification :	1.000000	X-axis angle :	0.000000
Y magnification :	1.000000	Y-axis angle :	90.000000
Origin X :	0.000000	XY-axis angle :	90.000000
Origin Y :	0.000000		

Item	Description
A	These are calibration conversion values. Camera coordinates are converted to actual coordinates based on these values. The conversion expressions to actual coordinates are as follows: (X,Y): Measurement point (camera coordinates), unit: pixel (X',Y'): Conversion point (actual coordinates) $X' = A \times X + B \times Y + C$ $Y' = D \times X + E \times Y + F$
B	
C	
D	
E	
F	
X magnification	Magnification ratio for the X-axis in the coordinate system after calibration.
Y magnification	Magnification ratio for the Y-axis in the coordinate system after calibration.
Origin X	The origin X position in the coordinate system after calibration.
Origin Y	The origin Y position in the coordinate system after calibration.
X-axis angle	The X-axis angle in the coordinate system after calibration.
Y-axis angle	The Y-axis angle in the coordinate system after calibration.
XY-axis angle	Angle formed by the X-axis and Y-axis in the coordinate system after calibration.

Edit the Calibration Result

When calibration parameters have already known, you can directly edit the generated calibration parameters.

- 1 Click **Edit enable** in the *Calibration data* area.
The calibration parameters A to F will become available for editing.

Calibration data			
A :	<input type="text" value="1.000000"/>	D :	<input type="text" value="0.000000"/>
B :	<input type="text" value="0.000000"/>	E :	<input type="text" value="1.000000"/>
C :	<input type="text" value="0.000000"/>	F :	<input type="text" value="0.000000"/>
X magnification :	1.000000	X-axis angle :	0.000000
Y magnification :	1.000000	Y-axis angle :	90.000000
Origin X :	0.000000	XY-axis angle :	90.000000
Origin Y :	0.000000		

- 2 Check the edited results in the *Calibration parameter* area.

Calibration data			
A :	1.000000	D :	0.000000
B :	0.000000	E :	1.000000
C :	0.000000	F :	0.000000
X magnification :	1.000000	X-axis angle :	0.000000
Y magnification :	1.000000	Y-axis angle :	90.000000
Origin X :	0.000000	XY-axis angle :	90.000000
Origin Y :	0.000000		

Compensate the Calibration Result

The calibration result can be compensated by setting the compensation amounts such as magnification ratios and offsets for the actual dimensions and actual coordinates.

- 1 In the *Parameter* area, set the compensation values.

Parameter	
Corrected X magnification :	<input type="text" value="1.0000"/>
Corrected Y magnification :	<input type="text" value="1.0000"/>
Corrected X-axis angle :	<input type="text" value="0.0000"/>
Corrected Y-axis angle :	<input type="text" value="0.0000"/>
Origin X offset :	<input type="text" value="0.0000"/>
Origin Y offset :	<input type="text" value="0.0000"/>

Setting item	Setting value [Factory default]	Description
Corrected X/Y magnification	0.5000 to 1.5000 [1.0000]	Sets the compensation amounts for the X- and Y-axis magnification ratio respectively.
Corrected X-/Y-axis angle	-180.0000 to 180.0000 [0]	Sets the compensation amounts for the X- and Y-axis angle respectively.
Origin X/Y offset	-9,999.9999 to 9,999.9999 [0]	Sets the compensation amounts for the X and Y coordinates of the origin respectively.

- 2 In the *Calibration parameter* area, check the compensation results.



Additional Information

The following relational expressions are established between calibration parameters and compensation values. Be careful about the relationships between the compensation parameters before and after compensation when adjusting parameters.

Before adjustment: A1, B1, C1, D1, E1, F1

After adjustment: A2, B2, C2, D2, E2, F2

Compensation ratio X: KX, Compensation ratio Y: KY

Compensation angle X: θX , Compensation angle Y: θY

X origin offset setting: OX

Y origin offset setting: OY

- $A2 = KX \times (A1 \times \cos\theta X - D1 \times \sin\theta X)$
- $B2 = KY \times (B1 \times \cos\theta Y - E1 \times \sin\theta Y)$
- $C2 = C1 - OX$
- $D2 = KX \times (A1 \times \sin\theta X + D1 \times \cos\theta X)$
- $E2 = KY \times (B1 \times \sin\theta Y + E1 \times \cos\theta Y)$
- $F2 = F1 - OY$

4-33-7 Measurement Results for Which Output Is Possible (Camera Calibration)

The following values can be output using processing items related to result output. It is also possible to reference measurement values from calculation expressions and other processing units.

Measurement items	Character string	Description
Judge	JG	Judgment results 0: No judgment (unmeasured) 1: Judgment result OK -1: Judgment result NG -10: Error (image format mismatch) -11: Error (unregistered model) -12: Error (insufficient memory) -20: Error (other errors)

4-33-8 External Reference Tables (Camera Calibration)

No.	Data name	Data ident	Set/Get	Data range
0	Judge	judge	Get only	0: No judgment (unmeasured), 1: Judgment result OK, -1: Judgment result NG
5	A(corrected)	calibParamA	Get only	-
6	B(corrected)	calibParamB	Get only	-
7	C(corrected)	calibParamC	Get only	-
8	D(corrected)	calibParamD	Get only	-
9	E(corrected)	calibParamE	Get only	-
10	F(corrected)	calibParamF	Get only	-
11	X magnification(corrected)	scaleX	Get only	-
12	Y magnification(corrected)	scaleY	Get only	-
13	Origin X(corrected)	centerX	Get only	-
14	Origin Y(corrected)	centerY	Get only	-

No.	Data name	Data ident	Set/Get	Data range
15	X-axis angle(corrected)	angleX	Get only	-
16	Y-axis angle(corrected)	angleY	Get only	-
17	XY-axis angle(corrected)	angleXY	Get only	-
120	Point number(Point)	pointNum	Set/Get	0 to 100
121	Operating point No.	operatePointNo	Set/Get	-1 to 99
130	Coordinate(Value)	valCoordinate	Set/Get	0: Righthand, 1: Lefthand
131	Origin(Value)	valOrigin	Set/Get	0: Upperleft, 1: Lowerleft, 2: Center, 3: Point set
132	Magnification(Value)	valScale	Set/Get	0.0001 to 9.9999
134	Camera X(Value)	valCameraX	Set/Get	-99,999.9999 to 99,999.9999
135	Camera Y(Value)	valCameraY	Set/Get	-99,999.9999 to 99,999.9999
136	Transferred X(Value)	valTransX	Set/Get	-99,999.9999 to 99,999.9999
137	Transferred Y(Value)	valTransY	Set/Get	-99,999.9999 to 99,999.9999
140	Point number(Sampling)	samplingPointNum	Set/Get	0 to 100
141	Operating sampling No.	operateSamplingNo	Set/Get	-1 to 99
142	X unit No.	samplingUnitX	Set/Get	-1: No reference 0 to 9,999: Refer to unit No.
144	Y unit No.	samplingUnitY	Set/Get	-1: No reference 0 to 9,999: Refer to unit No.
147	Sampling mode	samplingMode	Set/Get	0: Difference, 1: Same
148	Display setting(Sampling)	dispSettingSampling	Set/Get	0: Input image, 1: X unit image, 2: Y unit image
150	Coordinate(Dimension)	dimCoordinate	Set/Get	0: Righthand, 1: Lefthand
151	Origin(Dimension)	dimOrigin	Set/Get	0: Upperleft, 1: Lowerleft, 2: Center, 3: Point set
152	Length	dimLength	Set/Get	0.0001 to 99,999.9999
154	Camera X(Dimension)	dimCameraX	Set/Get	-99,999.9999 to 99,999.9999
155	Camera Y(Dimension)	dimCameraY	Set/Get	-99,999.9999 to 99,999.9999
156	Transferred X(Dimension)	dimTransX	Set/Get	-99,999.9999 to 99,999.9999
157	Transferred Y(Dimension)	dimTransY	Set/Get	-99,999.9999 to 99,999.9999
158	Width unit No.	dimWidthUnit	Set/Get	-1: No reference 0 to 9,999: Refer to unit No.
159	Point1 unit No.	dimPointUnit1	Set/Get	-1: No reference 0 to 9,999: Refer to unit No.
160	Point2 unit No.	dimPointUnit2	Set/Get	-1: No reference 0 to 9,999: Refer to unit No.
161	Dimension mode	dimMode	Set/Get	0: Width, 1: 2 points
162	Display setting(Width)	dispSettingWidth	Set/Get	0: Input image 1: Width unit image

No.	Data name	Data ident	Set/Get	Data range
163	Display setting(Points)	dispSettingWidth-Point	Set/Get	0: Input image, 1: Point1 unit image, 2: Point2 unit image
170	A(uncorrected)	calibParamA_src	Set/Get	-999,999,999.999999 to 999,999,999.999999
171	B(uncorrected)	calibParamB_src	Set/Get	-999,999,999.999999 to 999,999,999.999999
172	C(uncorrected)	calibParamC_src	Set/Get	-999,999,999.999999 to 999,999,999.999999
173	D(uncorrected)	calibParamD_src	Set/Get	-999,999,999.999999 to 999,999,999.999999
174	E(uncorrected)	calibParamE_src	Set/Get	-999,999,999.999999 to 999,999,999.999999
175	F(uncorrected)	calibParamF_src	Set/Get	-999,999,999.999999 to 999,999,999.999999
176	X magnification(uncorrected)	scaleX_src	Get only	-
177	Y magnification(uncorrected)	scaleY_src	Get only	-
178	Origin X(uncorrected)	centerX_src	Get only	-
179	Origin Y(uncorrected)	centerY_src	Get only	-
180	X-axis angle(uncorrected)	angleX_src	Get only	-
181	Y-axis angle(uncorrected)	angleY_src	Get only	-
182	XY-axis angle(uncorrected)	angleXY_src	Get only	-
183	Corrected X magnification	correctScaleX	Set/Get	0.5000 to 1.5000
184	Corrected Y magnification	correctScaleY	Set/Get	0.5000 to 1.5000
185	Corrected X-axis angle	correctAngleX	Set/Get	-180 to 180
186	Corrected Y-axis angle	correctAngleY	Set/Get	-180 to 180
187	Origin X offset	correctCenterX	Set/Get	-9,999.9999 to 9,999.9999
188	Origin Y offset	correctCenterY	Set/Get	-9,999.9999 to 9,999.9999
200+N (N=0 to 99)	camera X of specified point	pointCameraX_00 to pointCameraX_99	Set/Get	0 to 99,999.9999
300+N (N=0 to 99)	camera Y of specified point	pointCameraY_00 to pointCameraY_99	Set/Get	0 to 99,999.9999
400+N (N=0 to 99)	real X of specified point	pointRealX_00 to pointRealX_99	Set/Get	-99,999.9999 to 99,999.9999
500+N (N=0 to 99)	real Y of specified point	pointRealY_00 to pointRealY_99	Set/Get	-99,999.9999 to 99,999.9999
600+N (N=0 to 99)	camera X of sampling point	samplingPositionX_00 to samplingPositionX_99	Set/Get	0 to 99,999.9999

No.	Data name	Data ident	Set/Get	Data range
700+N (N=0 to 99)	camera Y of sampling point	samplingPositionY_00 to samplingPositionY_99	Set/Get	0 to 99,999.9999
800+N (N=0 to 99)	real X of sampling point	realPositionX_00 to realPositionX_99	Set/Get	-99,999.9999 to 99,999.9999
900+N (N=0 to 99)	real Y of sampling point	realPositionY_00 to realPositionY_99	Set/Get	-99,999.9999 to 99,999.9999

4-34 Data Save

This processing item is not available in the FHV series.

Saves the calculation result of the expression as processing unit data.

Use this function when you want to retain the calculation result of the expression after restarting the controller.

You need to click **Data Save** and save the Scene data.

Used in the Following Case

When holding measurement values or count values even after the Sensor Controller is turned off:

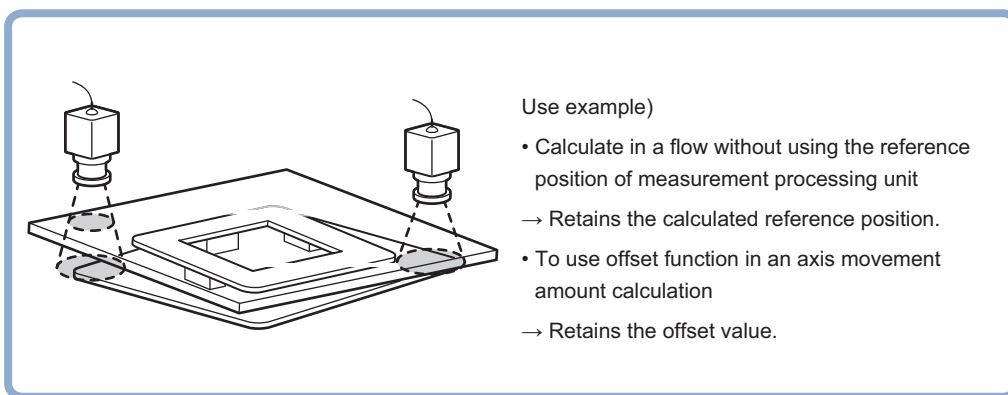

4-34-1 Setting (Data Save)

Set data to keep in this processing item.

It can be freely set using calculation expressions.

- 1** In the Item tab area, click **Setting**.
- 2** In the *Data save* area, set each item.
Up to 16 data can be saved.

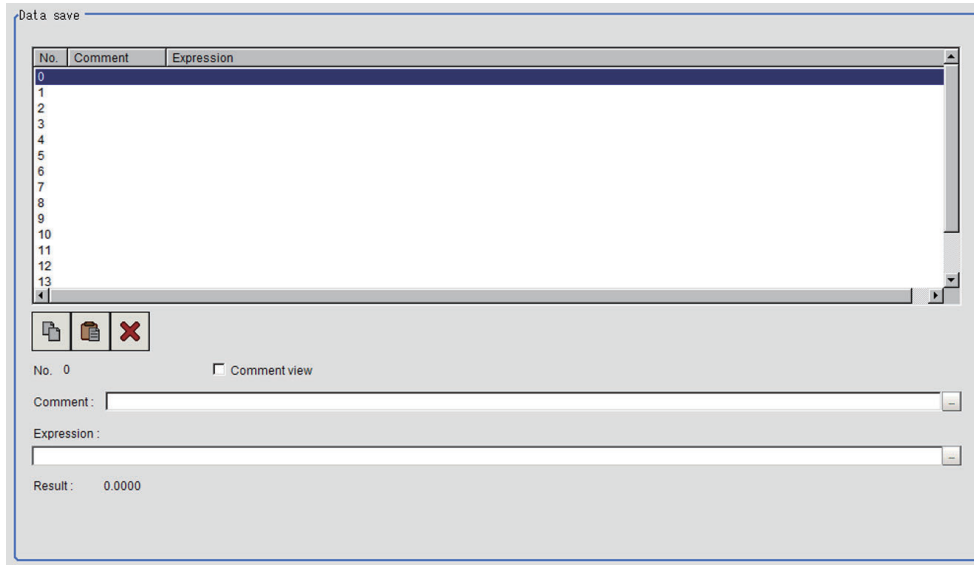

Setting item	Setting value [Factory default]	Description
Comment	-	Sets comment to describe the expression for the data to be saved. Multilingual is also supported. For details, refer to <i>Inputting Text</i> in the <i>Vision System FH/FHV Series User's Manual</i> (Cat. No. Z365).
Expression	-	Sets the expression for the data to be saved.

- 3** Place a check to *Comment view* to display it in the **Detail Result Pane** area,

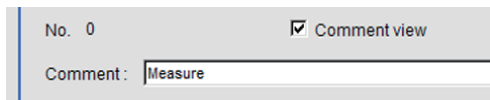

4-34-2 Key Points for Test Measurement and Adjustment (Data Save)

The following content is displayed in the *Detail result* area as text.

Displayed item	Description
Judge	Judgment results 0: No judgment (unmeasured) 1: Judgment result OK -1: Judgment result NG -10: Error (image format mismatch) -11: Error (unregistered model) -12: Error (insufficient memory) -20: Error (other errors)
Save data N (N = 0 to 15)	Stored data

Key Points for Adjustment (Data Save)

Adjust the setting parameters referring to the following points.

● **Saved data is updated unintentionally**

Parameter to be adjusted	Remedy
Measurement flow	The update can be controlled by setting the following flow. Example) 0. Camera image input 1. Input condition branching : N. Measurement completion N+1. Save data Control the DI signal so that it branches to saving data when updating saved data.

4-34-3 Measurement Results for Which Output Is Possible (Data Save)

The following values can be output using processing items related to result output. It is also possible to reference measurement values from calculation expressions and other processing units.

Measurement items	Character string	Description
Judge	JG	Judgment results 0: No judgment (unmeasured) 1: Judgment result OK -1: Judgment result NG -10: Error (image format mismatch) -11: Error (unregistered model) -12: Error (insufficient memory) -20: Error (other errors)
Stored data N (N = 0 to 15)	D00 to 15	Stored data

4-34-4 External Reference Tables (Data Save)

No.	Data name	Data ident	Set/Get	Data range
0	Judge	Judge	Get only	0: No judgment (unmeasured), 1: Judgment result OK, -1: Judgment result NG, -10: Error (image format mismatch), -11: Error (unregistered model), -12: Error (insufficient memory), -20: Error (other errors)
5+N (N=0 to 15)	Expression result of expression	resultData00 to resultData15	Get only	-999,999,999.9999 to 999,999,999.9999
120+N (N=0 to 15)	Save data calculation	setupData00 to setupData15	Set/Get	Exp. character string
136+N (N=0 to 15)	Save Data	saveData00 to saveData15	Set/Get	-999,999,999.9999 to 999,999,999.9999
168+N (N=0 to 15)	Expressions comment	comment00 to comment15	Set/Get	Character string
200+N (N=0 to 15)	Comment view	commentView00 to commentView15	Set/Get	0: OFF, 1: ON

4-35 Stage Data

This processing item is used to set and hold data for a stage connected to the Sensor Controller. Set the data based on the stage specifications you are going to use.

When using the following processing items that operate a stage or use its data, refer to this processing item.

- Vision Master Calibration
- PLC Master Calibration
- Calibration Data Reference
- Transfer Position Data
- Calc Axis Move
- Calc Axis Move by Multipoint

Used in the Following Case

When setting parameters for the type of stage or rotation polarity to be used.

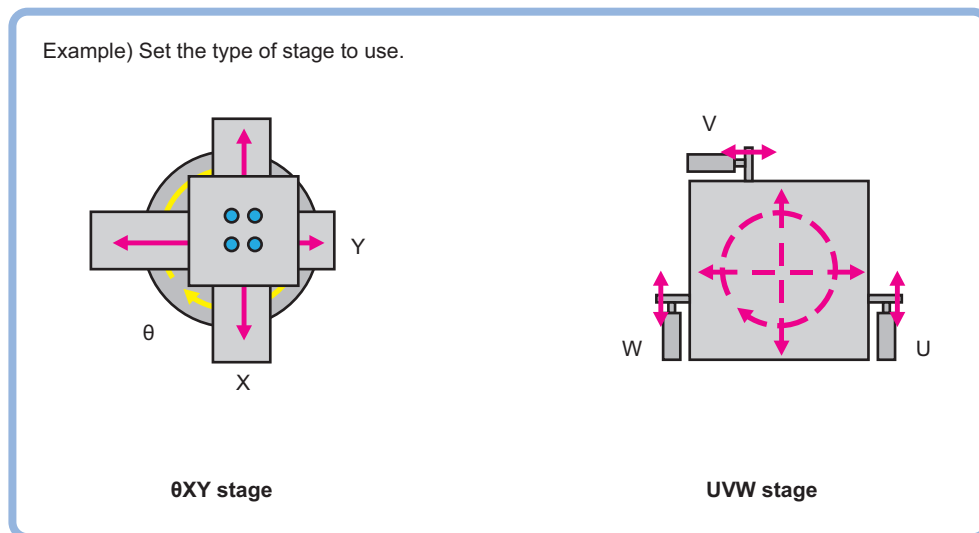

4-35-1 Data Setting (Stage Data)



Here sets the type of stage to be used and parameters. Select the stage to be used and set the parameters according to the selected stage.

When operating the stage or using the stage data, refer to this processing item from other processing items.

Selecting the Type of Stage (Stage Data)

- 1 In the *Stage setting* area, click at the *Stage type* to select the stage to be used. Stages that this device can use are displayed.
- 2 When *XYθ stage*, *θXY stage*, *Xθ(Yθ) stage*, or *θX(θY) stage* is selected, *Rotation polarity* becomes selectable. Place a check at the polarity corresponding to the selected stage.

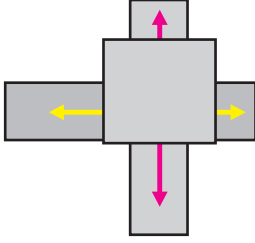
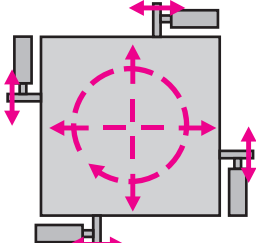
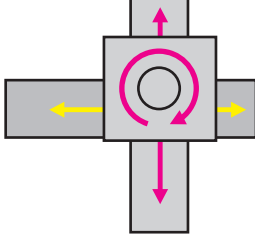

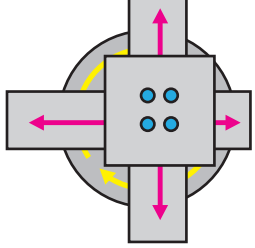
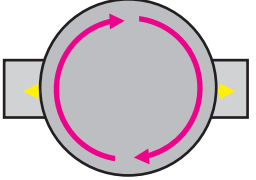
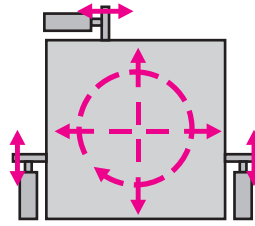
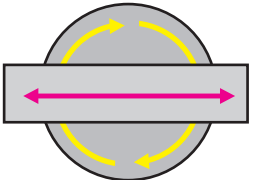
Setting item	Setting value [Factory default]	Description
Stage type	<ul style="list-style-type: none"> • [XY stage] • XYθ stage • θXY stage • UVW stage • UVWR stage • Xθ(Yθ) stage • θX(θY) stage • X(Y) stage 	<p>Selects the stage from the usable <i>Stage type</i> displayed. Usable <i>Stage type</i> is as follows.</p> <div style="display: flex; flex-wrap: wrap;"> <div style="width: 50%;"> <p>XY stage</p>  </div> <div style="width: 50%;"> <p>UVWR stage</p>  </div> <div style="width: 50%;"> <p>XYθ stage</p>  </div> <div style="width: 50%;"> <p>X(Y) stage</p>  <p>When you select [X-axis] as measurement axis, [X-stage] is set. When you select [Y-axis] as measurement axis, [Y-stage] is set.</p> </div> <div style="width: 50%;"> <p>θXY stage</p>  </div> <div style="width: 50%;"> <p>Xθ(Yθ) stage</p>  <p>When you select [X-axis] as measurement axis, [Xθ-stage] is set. When you select [Y-axis] as measurement axis, [Yθ-stage] is set.</p> </div> <div style="width: 50%;"> <p>UVW stage</p>  </div> <div style="width: 50%;"> <p>θX(θY) stage</p>  <p>When you select [X-axis] as measurement axis, [θX-stage] is set. When you select [Y-axis] as measurement axis, [θY-stage] is set.</p> </div> </div> <p>When XY stage, UVW stage, UVRW stage, or X(Y) stage is selected, the <i>Rotation polarity</i> will be disabled.</p>

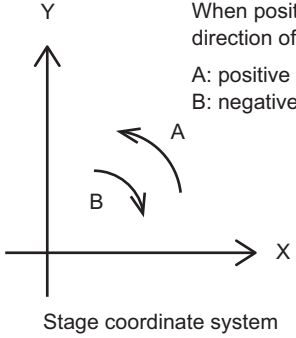
Setting item	Setting value [Factory default]	Description
Rotation polarity	<ul style="list-style-type: none"> • [Positive] • Negative 	<p>Selects the rotation direction defined as the equipment based on that of the robot coordinate system.</p> <ul style="list-style-type: none"> • Positive: From X-axis to Y-axis • Negative: From Y-axis to X-axis  <p>When positive rotation direction of the device is A: positive polarity B: negative polarity</p> <p>Stage coordinate system</p>

Setting the Data for Each Stage (XY Stage)

Here sets XY stage that is 2-axis stage.

- 1 When selecting *XY stage*, the *XY stage setting* area is displayed.

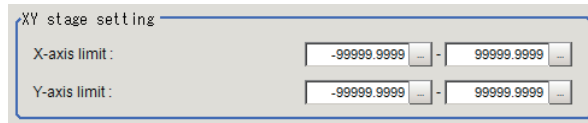

- 2 In the *XY stage setting* area, click at the right side of *X-axis limit* to set the upper and lower limit values.
- 3 Likewise, click at the right side of *Y-axis limit* to set the upper and lower limit values.

Setting item	Setting value [Factory default]	Description
X-axis limit	-99,999.9999 to 99,999.9999 [-99,999.9999] to [99,999.9999]	Sets the upper and lower limits for the X-axis movement range. The unit used is a coordinate system set in calibration.
Y-axis limit	-99,999.9999 to 99,999.9999 [-99,999.9999] to [99,999.9999]	Sets the upper and lower limits for the Y-axis movement range. The unit used is a coordinate system set in calibration.

Setting the Data for Each Stage (XYθ Stage and θXY Stage)

Here sets XYθ stage or θXY stage that is 3-axis stage.

- 1 When selecting *XYθ stage* or *θXY stage*, the *XYθ stage setting* area is displayed.

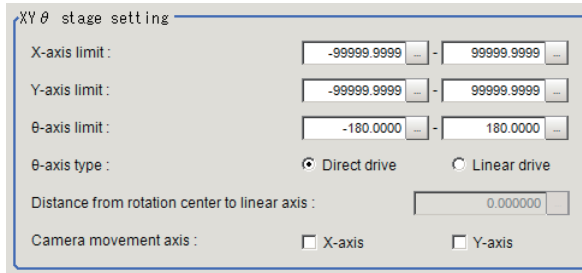

- 2 In the *XY stage setting* area, click at the right side of the *X-axis limit* to set the upper and lower limit values.
- 3 Likewise, click at the right side of the *Y-axis limit* to set the upper and lower limit values.
- 4 Likewise, click at the right side of the *θ-axis limit* to set the upper and lower limit values.
- 5 Select the *θ-axis drive system* in the *θ-axis type*.
- 6 When selecting *Direct drive* in the *θ-axis type*, *Distance from rotation center to linear axis* will be available, so set a numeric value by clicking .
- 7 When using the camera by moving it, select the axis to mount the camera from the *Camera movement axis*.

Setting item	Setting value [Factory default]	Description
X-axis limit	-99,999.9999 to 99,999.9999 [-99,999.9999] to [99,999.9999]	Sets the upper and lower limits for the X-axis movement range. The unit used is a coordinate system set in calibration.
Y-axis limit	-99,999.9999 to 99,999.9999 [-99,999.9999] to [99,999.9999]	Sets the upper and lower limits for the Y-axis movement range. The unit used is a coordinate system set in calibration.
θ-axis limit	-180.0000 to 180.0000 [-180.0000] to [180.0000]	Sets the upper and lower limits for θ-axis angle movement range. Unit: degree

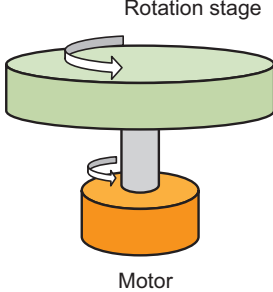
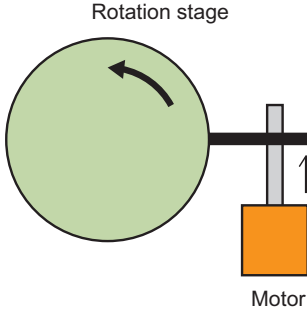
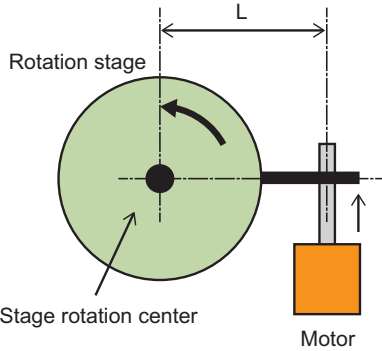













Setting item		Setting value [Factory default]	Description
θ-axis type		<ul style="list-style-type: none"> [Direct drive] Linear drive 	<p>Selects the type of θ-axis drive.</p> <ul style="list-style-type: none"> Direct drive: A drive system which the direction of θ-axis rotation is the same as that of the motor shaft.  <ul style="list-style-type: none"> Linear drive: A system which controls the θ-axis rotation by the linear movement. 
	Distance from rotation center to linear axis	0.0000 to 99,999.9999 [0.0000]	<p>For the linear drive system, set the distance (L) from the stage rotation center to the linear axis.</p> 
Camera movement axis	X-axis	<ul style="list-style-type: none"> Checked [Unchecked] 	Enable this setting when the camera moves instead of the stage axis.
	Y-axis	<ul style="list-style-type: none"> Checked [Unchecked] 	When this is disabled, a movement amount and so on is calculated on the premise that the stage moves.

Setting the Data for Each Stage (UVW Stage and UVWR Stage)

Here sets UVW stage that is 3-axis stage or UVWR stage that is 4-axis stage.





- 1 When *UVW stage* or *UVWR stage* is selected, *UVW stage setting area* or *UVWR stage setting area* is displayed.

- 2 Select the type of fulcrum in the *Fulcrum type*.
- 3 Click at the right side of the *U-axis direction* and set the axis direction of U-axis to either positive or negative versus the X- or Y-axis direction in the XY coordinate system which is in parallel or perpendicular to each UVWR axis.
- 4 Click at the right side of the *U-axis limit* to set the upper and lower limit values.
- 5 Likewise, click at the right side of the *V-axis direction* and set the axis direction of V-axis to either positive or negative versus the X- or Y-axis direction in the XY coordinate system which is in parallel or perpendicular to each UVWR axes.
- 6 Click at the right side of the *V-axis limit* to set the upper and lower limit values.
- 7 Likewise, click at the right side of the *W-axis direction* and set the axis direction of W-axis to either positive or negative versus the X- or Y-axis direction in the XY coordinate system which is in parallel or perpendicular to each UVWR axes.
- 8 Click at the right side of the *W-axis limit* to set the upper and lower limit values.
- 9 Likewise, click at the right side of the *R-axis direction* and set the axis direction of R-axis to either positive or negative versus the X- or Y-axis direction in the XY coordinate system which is in parallel or perpendicular to each UVWR axes.
- 10 Click at the right side of the *R-axis limit* to set the upper and lower limit values.
- 11 In the *Axis parameter setting* area, select the fulcrum parameter setting for each UVWR axis either by *Setting by XY coordinate system* or *Setting by Polar coordinate system*.
- 12 When selecting the *Setting by XY coordinate system* in the *Axis parameter setting*, the *Setting by XY coordinate system* area will be enabled.
- 13 In the *Setting by XY coordinate system* area, click at the right side of the *UX* to set a value.

- 14** Likewise, In the *Setting by XY coordinate system* area, click  at the right side of the *UY* to set a value for the Y coordinate of U-axis fulcrum in the origin return state.
- 15** Likewise, In the *Setting by XY coordinate system* area, click  at the right side of the *VX* to set a value for the X coordinate of V-axis fulcrum in the origin return state.
- 16** Likewise, In the *Setting by XY coordinate system* area, click  at the right side of the *VY* to set a value for the Y coordinate of V-axis fulcrum in the origin return state.
- 17** Likewise, In the *Setting by XY coordinate system* area, click  at the right side of the *WX* to set a value for the X coordinate of W-axis fulcrum in the origin return state.
- 18** Likewise, In the *Setting by XY coordinate system* area, click  at the right side of the *WY* to set a value for the Y coordinate of W-axis fulcrum in the origin return state.
- 19** Likewise, In the *Setting by XY coordinate system* area, click  at the right side of the *RX* to set a value for the X coordinate of R-axis fulcrum in the origin return state.
- 20** Likewise, In the *Setting by XY coordinate system* area, click  at the right side of the *RY* to set a value for the Y coordinate of R-axis fulcrum in the origin return state.
- 21** Likewise, In the *Setting by XY coordinate system* area, click  at the right side of the *Rotation center X* to set a value for the rotation center X coordinate of in the origin return state.
- 22** Likewise, In the *Setting by XY coordinate system* area, click  at the right side of the *Rotation center Y* to set a value for the rotation center Y coordinate of in the origin return state.
- 23** When selecting the *Setting by Polar coordinate system* in the *Axis parameter setting*, the *Setting by Polar coordinate system* area will be enabled.
- 24** In the *Setting by Polar coordinate system* area, click  at the right side of the *R1* to set distance between the U-axis fulcrum and the rotation center in the origin rerun state.
- 25** In the *Setting by Polar coordinate system* area, click  at the right side of the *R2* to set distance between the V-axis fulcrum and the rotation center in the origin rerun state.
- 26** In the *Setting by Polar coordinate system* area, click  at the right side of the *R3* to set distance between the W-axis fulcrum and the rotation center in the origin rerun state.
- 27** In the *Setting by Polar coordinate system* area, click  at the right side of the *R4* to set distance between the R-axis fulcrum and the rotation center in the origin rerun state.
- 28** In the *Setting by Polar coordinate system* area, click  at the right side of the $\theta 1$ to set a value.
- 29** In the *Setting by Polar coordinate system* area, click  at the right side of the $\theta 2$ to set a value.

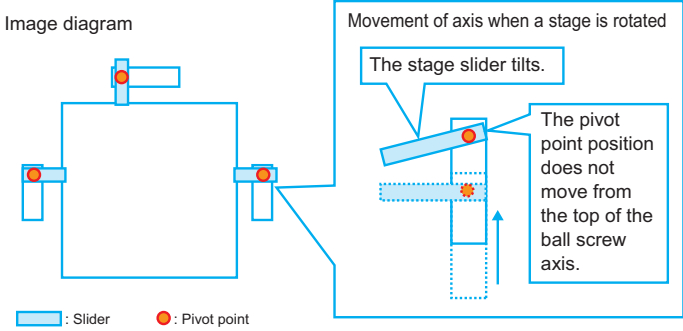
30 In the *Setting by Polar coordinate system* area, click  at the right side of the $\theta 3$ to set a value.

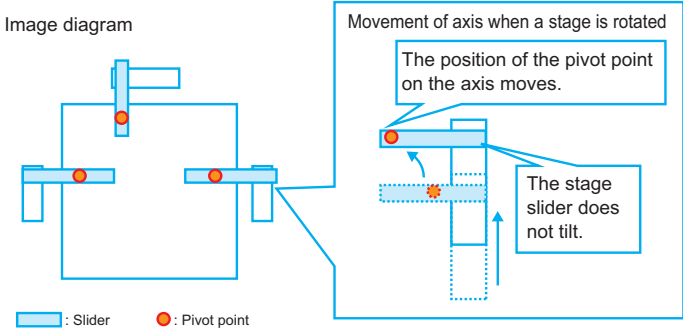
31 In the *Setting by Polar coordinate system* area, click  at the right side of the $\theta 4$ to set a value.

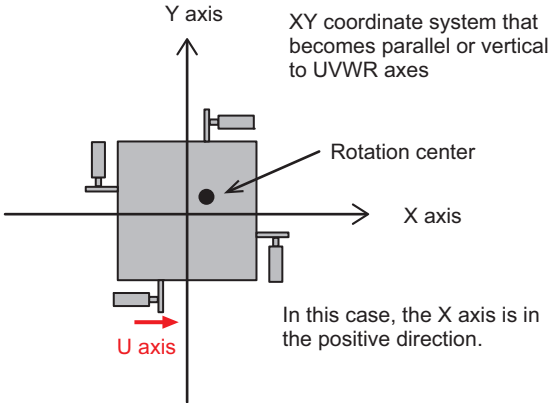
Setting item	Setting value [Factory default]	Description
Fulcrum type	<ul style="list-style-type: none"> Linear [Rotation] 	<p>Select the slider operation type when the stage is rotated</p> <ul style="list-style-type: none"> Linear: <div data-bbox="767 636 1453 965"> <p>Image diagram</p>  <p>Movement of axis when a stage is rotated</p> <p>The stage slider tilts.</p> <p>The pivot point position does not move from the top of the ball screw axis.</p> <p>Legend:  : Slider  : Pivot point</p> </div> Rotation: <div data-bbox="767 1066 1453 1395"> <p>Image diagram</p>  <p>Movement of axis when a stage is rotated</p> <p>The position of the pivot point on the axis moves.</p> <p>The stage slider does not tilt.</p> <p>Legend:  : Slider  : Pivot point</p> </div>
U-axis direction	<ul style="list-style-type: none"> [X-axis positive] X-axis negative Y-axis positive Y-axis negative 	<p>For the axis direction of the U-axis, set the rotation center as the point of origin then set it to either positive or negative versus the X- or Y-axis direction in the XY coordinate system which is parallel or perpendicular to each UVWR axis.</p> <div data-bbox="730 1597 1283 1998">  <p>Y axis</p> <p>XY coordinate system that becomes parallel or vertical to UVWR axes</p> <p>Rotation center</p> <p>X axis</p> <p>U axis</p> <p>In this case, the X axis is in the positive direction.</p> </div>

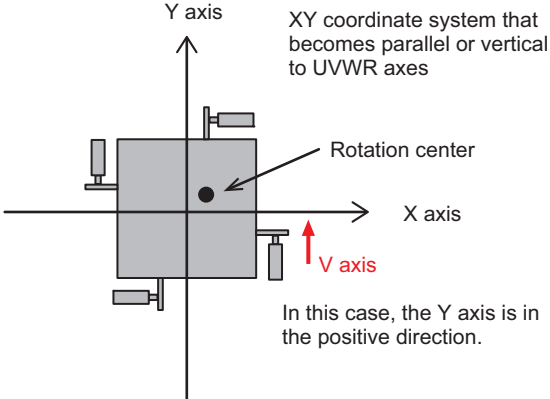
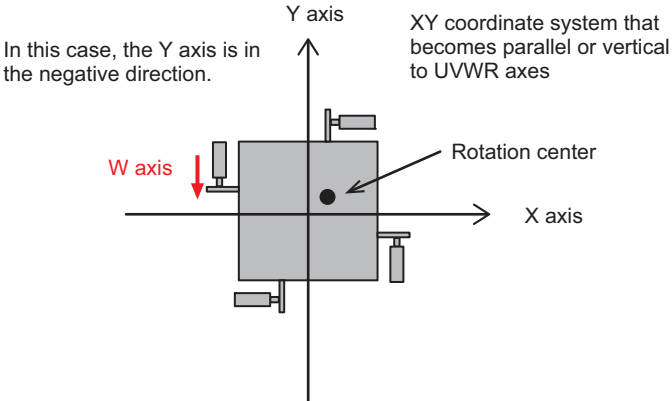
Setting item	Setting value [Factory default]	Description
U-axis limit	-99,999.9999 to 99,999.9999 [-99,999.9999] to [99,999.9999]	Sets the upper and lower limit values for U-axis movement range. The unit used is a coordinate system set in calibration.
V-axis direction	<ul style="list-style-type: none"> • [X-axis positive] • X-axis negative • Y-axis positive • Y-axis negative 	<p>For the axis direction of the V-axis, set the rotation center as the point of origin then set it to either positive or negative versus the X- or Y-axis direction in the XY coordinate system which is parallel or perpendicular to each UVWR axis.</p> 
V-axis limit	-99,999.9999 to 99,999.9999 [-99,999.9999] to [99,999.9999]	Sets the upper and lower limit values for V-axis movement range. The unit used is a coordinate system set in calibration.
W-axis direction	<ul style="list-style-type: none"> • [X-axis positive] • X-axis negative • Y-axis positive • Y-axis negative 	<p>For the axis direction of the W-axis, set the rotation center as the point of origin then set it to either positive or negative versus the X- or Y-axis direction in the XY coordinate system which is parallel or perpendicular to each UVWR axis.</p> 
W-axis limit	-99,999.9999 to 99,999.9999 [-99,999.9999] to [99,999.9999]	Sets the upper and lower limit values for W-axis movement range. The unit used is a coordinate system set in calibration.

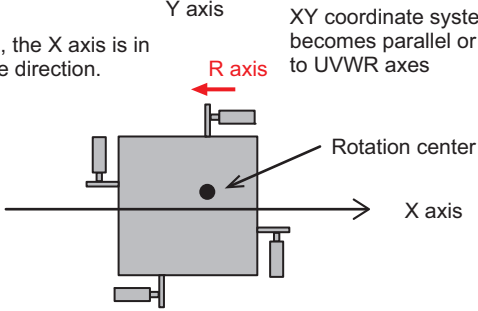
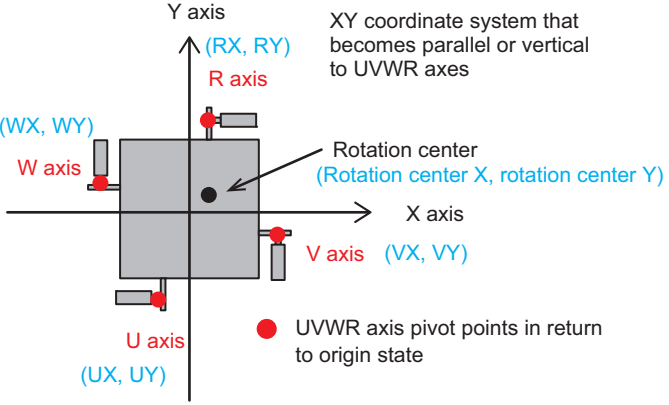
Setting item	Setting value [Factory default]	Description
R-axis direction	<ul style="list-style-type: none"> • [X-axis positive] • X-axis negative • Y-axis positive • Y-axis negative 	<p>For the axis direction of the R-axis, set the rotation center as the point of origin then set it to either positive or negative versus the X- or Y-axis direction in the XY coordinate system which is parallel or perpendicular to each UVWR axis.</p> <p>In this case, the X axis is in the negative direction.</p> 
R-axis limit	-99,999.9999 to 99,999.9999 [-99,999.9999] to [99,999.9999]	Sets the upper and lower limit values for R-axis movement range. The unit used is a coordinate system set in calibration.
Axis parameter setting	<ul style="list-style-type: none"> • [Setting by XY coordinate system] • Setting by Polar coordinate system 	Selects the fulcrum parameter of each UVWR axis either by XY coordinate system or Polar coordinate system.
UX	-99,999.999999 to 99,999.999999	Sets the X coordinate value of the U-axis fulcrum in the origin return state. 
UY	-99,999.999999 to 99,999.999999 [0.000000]	Sets the Y coordinate value of the U-axis fulcrum in the origin return state.
VX	-99,999.999999 to 99,999.999999 [0.000000]	Sets the X coordinate value of the V-axis fulcrum in the origin return state.
VY	-99,999.999999 to 99,999.999999 [0.000000]	Sets the Y coordinate value of the V-axis fulcrum in the origin return state.
WX	-99,999.999999 to 99,999.999999 [0.000000]	Sets the X coordinate value of the W-axis fulcrum in the origin return state.

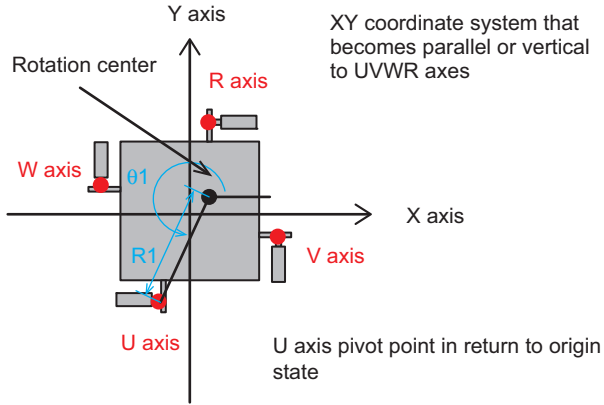
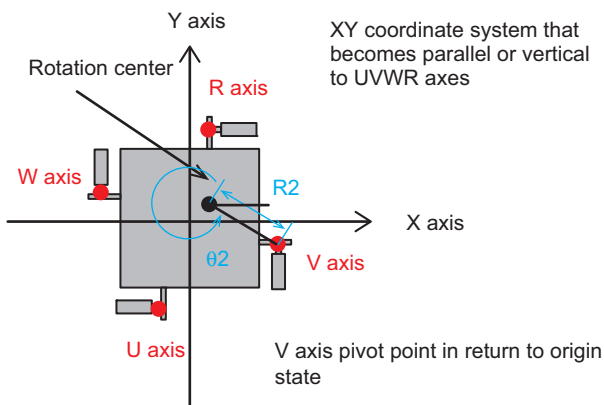
Setting item	Setting value [Factory default]	Description
WY	-99,999.999999 to 99,999.999999 [0.000000]	Sets the Y coordinate value of the W-axis fulcrum in the origin return state.
RX	-99,999.999999 to 99,999.999999 [0.000000]	Sets the X coordinate value of the R-axis fulcrum in the origin return state.
RY	-99,999.999999 to 99,999.999999 [0.000000]	Sets the Y coordinate value of the R-axis fulcrum in the origin return state.
Rotation center X	-99,999.999999 to 99,999.999999 [0.000000]	Sets the X coordinate value of the rotation center in the origin return state.
Rotation center Y	-99,999.999999 to 99,999.999999 [0.000000]	Sets the Y coordinate value of the rotation center in the origin return state.
R1	0.000000 to 99,999.999999 [0.000000]	<p>Sets the length of line segment connecting the stage rotation center and U-axis fulcrum in the origin return state (each axis movement amount is 0).</p>  <p>XY coordinate system that becomes parallel or vertical to UVWR axes</p> <p>U axis pivot point in return to origin state</p>
θ1	-360.000000 to 360.000000 [0.000000]	Sets the angle from the X-axis of the line segment connecting the stage rotation center and U-axis fulcrum in the origin return state (each axis movement amount is 0). As for the angle, the X-axis is set to 0° and the direction from X-axis positive direction to Y-axis positive one is set to +.
R2	0.000000 to 99,999.999999 [0.000000]	<p>Sets the length of line segment connecting the stage rotation center and V-axis fulcrum in the origin return state (each axis movement amount is 0).</p>  <p>XY coordinate system that becomes parallel or vertical to UVWR axes</p> <p>V axis pivot point in return to origin state</p>

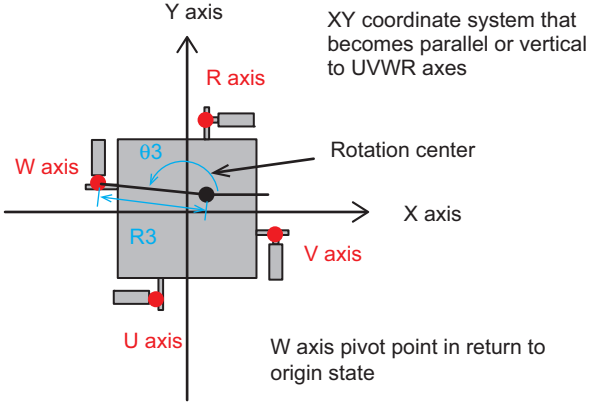
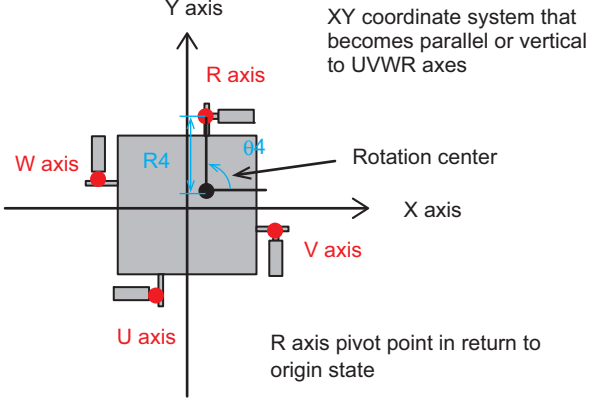
Setting item	Setting value [Factory default]	Description
θ2	-360.000000 to 360.000000 [0.000000]	Sets the angle from the X-axis of the line segment connecting the stage rotation center and V-axis fulcrum in the origin return state (each axis movement amount is 0).As for the angle, the X-axis is set to 0° and the direction from X-axis positive direction to Y-axis positive one is set to +.
R3	0.000000 to 99,999.999999 [0.000000]	Sets the length of line segment connecting the stage rotation center and W-axis fulcrum in the origin return state (each axis movement amount is 0). 
θ3	-360.000000 to 360.000000 [0.000000]	Sets the angle from the X-axis of the line segment connecting the stage rotation center and W-axis fulcrum in the origin return state (each axis movement amount is 0).As for the angle, the X-axis is set to 0° and the direction from X-axis positive direction to Y-axis positive one is set to +.
R4	0.000000 to 99,999.999999 [0.000000]	Sets the length of line segment connecting the stage rotation center and R-axis fulcrum in the origin return state (each axis movement amount is 0). 
θ4	-360.000000 to 360.000000 [0.000000]	Sets the angle from the X-axis of the line segment connecting the stage rotation center and R-axis fulcrum in the origin return state (each axis movement amount is 0).As for the angle, the X-axis is set to 0° and the direction from X-axis positive direction to Y-axis positive one is set to +.

Set Parameters Depending on Each of Stage (X θ Stage and Y θ stage)

Here sets X θ stage or Y θ stage that is 2-axis stage.

- 1 When selecting X θ (Y θ) stage in the *Stage type*, the X θ (Y θ) stage setting area is displayed. Set parameters in the X θ (Y θ) stage setting area.

- 2 Select the type of stage for the *Movement axis* in the X θ (Y θ) stage setting area. Selecting X-axis is set to X θ stage, and selecting Y-axis is set to Y θ stage. The name of parameters in the X θ (Y θ) stage setting area will be changed by selecting *Movement axis*.*1

When you select [X-axis]

When you select [Y-axis]

- 3 Select *Lefthand* or *Righthand* in the *Coordinate*.

- 4 Click at the right side of *Y-axis relative angle (X-axis standard)* to set the relative angle for X-axis.*1
- 5 Click at the right side of *Y-axis relative magnification (X-axis standard)* to set the relative magnification for X-axis.*1
- 6 Click at the right side of *X-axis limit* to set the upper and lower limit values for the movement axis of X-axis.*1
- 7 Click at the right side of *θ-axis limit* to set the upper and lower limit values for the θ-axis movement angle on the Xθ stage.
- 8 Select the moving method for the θ-axis in the *θ-axis type*.
- 9 When selecting *Linear drive* in the *θ-axis type*, the *Distance from rotation center to linear axis* becomes available to set. So set a numeric value by clicking .
- 10 When using the camera by moving it, select the axis to mount the camera from *Camera movement axis*.

Setting item	Setting value [Factory default]	Description
Movement axis	<ul style="list-style-type: none"> • [X-axis] • Y-axis 	<p>Selects the type of stage.</p> <p>Selecting <i>X-axis</i> is set to Xθ stage and selecting <i>Y-axis</i> is set to Yθ stage.</p>
Coordinate	<ul style="list-style-type: none"> • [Lefthand] • Righthand 	<p>Sets the coordinate system to be used.</p> <ul style="list-style-type: none"> • Lefthand The clockwise is forward when setting the coordinates. • Righthand The counter-clockwise is forward when setting the coordinates. <div style="text-align: center;"> </div>

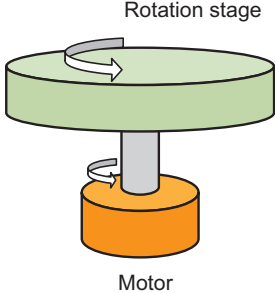
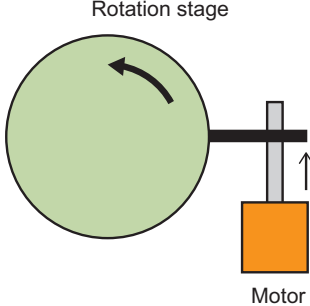
Setting item	Setting value [Factory default]	Description
Y-axis relative angle (X-axis standard) ^{*1}	0.000001 to 180.000000 [90.000000]	X-axis selected: Sets a virtually calculated relative angle of Y-axis into X-axis. Y-axis selected: Sets a virtually calculated relative angle of X-axis into Y-axis. Unit: degree
Y-axis relative magnification ^{*1}	0.100000 to 9.999999 [1.000000]	X-axis selected: Sets a virtually calculated relative magnification of Y-axis into X-axis. Y-axis selected: Sets a virtually calculated relative magnification of X-axis into Y-axis.
X-axis limit ^{*1}	-99,999.9999 to 99,999.9999 [-99,999.9999] to [99,999.9999]	X-axis selected: Sets the upper and lower limit values for the X-axis movement range. Y-axis selected: Sets the upper and lower limit values for the Y-axis movement range. The unit used is a coordinate system set in calibration.
θ-axis limit	-180.0000 to 180.0000 [-180.0000] to [180.0000]	Sets the upper and lower limit values for the θ-axis movement angle. Unit: degree
θ-axis type	<ul style="list-style-type: none"> [Direct drive] Linear drive 	<p>Selects the type of θ-axis drive.</p> <ul style="list-style-type: none"> Direct drive: A drive system which the direction of θ-axis rotation is the same as that of the motor shaft.  <ul style="list-style-type: none"> Linear drive: A system which controls the θ-axis rotation by the linear movement. 

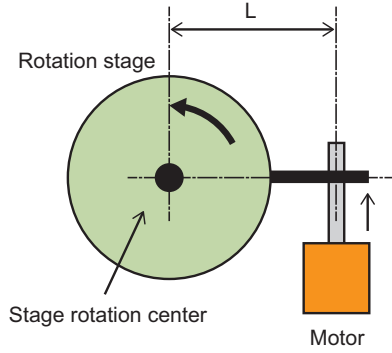
Setting item	Setting value [Factory default]	Description
Distance from rotation center to linear axis	0.0000 to 99,999.9999 [0.0000]	For the linear drive system, set the distance (L) from the stage rotation center to the linear axis. 
Camera movement axis	X-axis	<ul style="list-style-type: none"> • Checked • [Unchecked]
	Y-axis	<ul style="list-style-type: none"> • Checked • [Unchecked]

*1. The name of parameters noted is when X-axis is selected as the movement axis. When Y-axis is selected, the notation is changed like below.

X-axis is selected as the Measurement axis	Y-axis is selected as the Measurement axis
Y-axis relative angle (X-axis standard)	X-axis relative angle (Y-axis standard)
Y-axis relative magnification (X-axis standard)	X-axis relative magnification (Y-axis standard)
X-axis limit	Y-axis limit

Set Parameters Depending on Each of Stage (θX Stage and θY Stage)

Here sets θX stage or θY stage that is 2-axis stage.

- 1 When selecting $\theta X(\theta Y)$ stage in the *Stage type*, the $\theta X(\theta Y)$ stage setting area is displayed. Set parameters in the $\theta X(\theta Y)$ stage setting area.

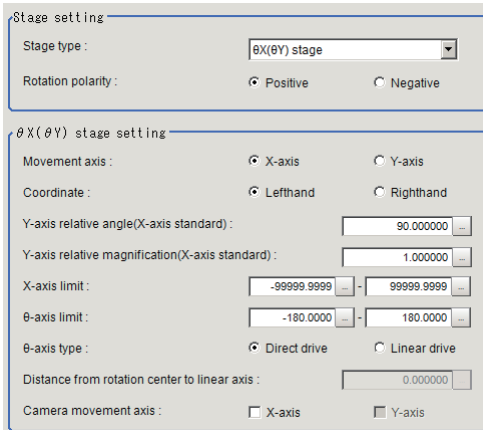

- 2 Select the type of stage for the *Movement axis* in the $\theta X(\theta Y)$ stage setting area. Selecting X-axis is set to θX stage, and selecting Y-axis is set to θY stage.

The name of parameters in the $X\theta(Y\theta)$ stage setting area will be changed by selecting *Movement axis*.*1

When you select [X-axis]

The screenshot shows the 'θ X (θ Y) stage setting' dialog box. The 'Movement axis' is set to 'X-axis'. The 'Coordinate' is set to 'Lefthand'. The 'Y-axis relative angle(X-axis standard)' is 90.000000. The 'Y-axis relative magnification(X-axis standard)' is 1.000000. The 'X-axis limit' is set to -99999.9999 and 99999.9999. The 'θ-axis limit' is set to -180.0000 and 180.0000. The 'θ-axis type' is set to 'Direct drive'. The 'Distance from rotation center to linear axis' is 0.000000. The 'Camera movement axis' is set to 'X-axis'.

When you select [Y-axis]

The screenshot shows the 'θ X (θ Y) stage setting' dialog box. The 'Movement axis' is set to 'Y-axis'. The 'Coordinate' is set to 'Lefthand'. The 'X-axis relative angle(Y-axis standard)' is 90.000000. The 'X-axis relative magnification(Y-axis standard)' is 1.000000. The 'Y-axis limit' is set to -99999.9999 and 99999.9999. The 'θ-axis limit' is set to -180.0000 and 180.0000. The 'θ-axis type' is set to 'Direct drive'. The 'Distance from rotation center to linear axis' is 0.000000. The 'Camera movement axis' is set to 'Y-axis'.

- 3 Select *Lefthand* or *Righthand* in the *Coordinate*.
- 4 Click at the right side of *Y-axis relative angle (X-axis standard)* to set the relative angle for X-axis.*1
- 5 Click at the right side of *Y-axis relative magnification (X-axis standard)* to set the relative magnification for X-axis.*1
- 6 Click at the right side of *X-axis limit* to set the upper and lower limit values for the movement axis of X-axis.*1
- 7 Click at the right side of *θ-axis limit* to set the upper and lower limit values for the θ-axis movement angle on the $X\theta$ stage.
- 8 Select the moving method for the θ-axis in the *θ-axis type*.
- 9 When selecting *Linear drive* in the *θ-axis type*, the *Distance from rotation center to linear axis* becomes available to set. So set a numeric value by clicking .
- 10 When using the camera by moving it, select the axis to mount the camera from *Camera movement axis*.

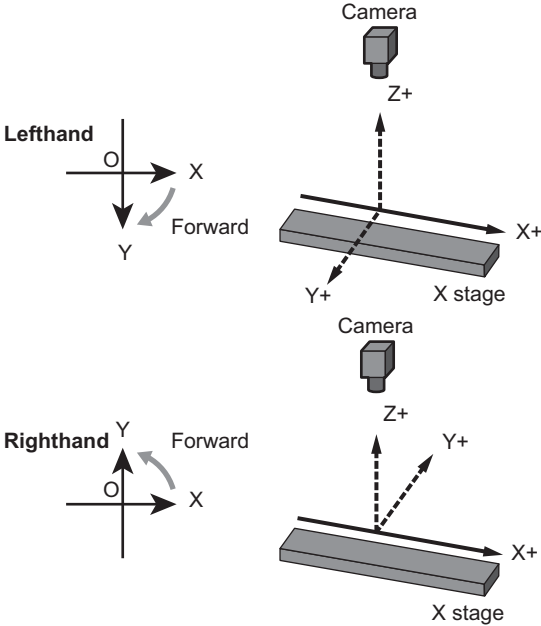
Setting item	Setting value [Factory default]	Description
Movement axis	<ul style="list-style-type: none"> • [X-axis] • Y-axis 	Selects the type of stage. Selecting X-axis is set to Xθ stage and selecting Y-axis is set to Yθ stage.
Coordinate	<ul style="list-style-type: none"> • [Lefthand] • Righthand 	Sets the coordinate system to be used. <ul style="list-style-type: none"> • Lefthand The clockwise is forward when setting the coordinates. • Righthand The counter-clockwise is forward when setting the coordinates. 
Y-axis relative angle (X-axis standard)*1	0.000001 to 180.000000 [90.000000]	X-axis selected: Sets a virtually calculated relative angle of Y-axis into X-axis. Y-axis selected: Sets a virtually calculated relative angle of X-axis into Y-axis. Unit: degree
Y-axis relative magnification*1	0.100000 to 9.999999 [1.000000]	X-axis selected: Sets a virtually calculated relative magnification of Y-axis into X-axis. Y-axis selected: Sets a virtually calculated relative magnification of X-axis into Y-axis.
X-axis limit*1	-99,999.9999 to 99,999.9999 [-99,999.9999] to [99,999.9999]	X-axis selected: Sets the upper and lower limit values for the X-axis movement range. Y-axis selected: Sets the upper and lower limit values for the Y-axis movement range. The unit used is a coordinate system set in calibration.
θ-axis limit	-180.0000 to 180.0000 [-180.0000] to [180.0000]	Sets the upper and lower limit values for the θ-axis movement angle. Unit: degree

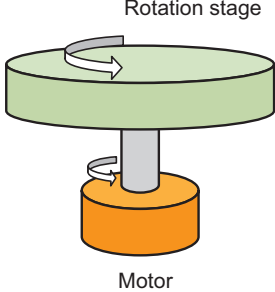
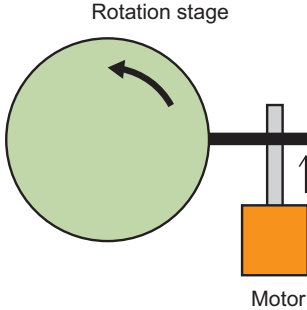
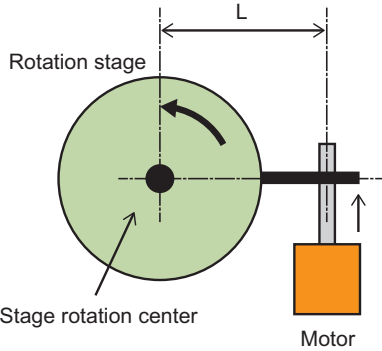
Setting item		Setting value [Factory default]	Description
θ-axis type		<ul style="list-style-type: none"> [Direct drive] Linear drive 	<p>Selects the type of θ-axis drive.</p> <ul style="list-style-type: none"> Direct drive: A drive system which the direction of θ-axis rotation is the same as that of the motor shaft.  <ul style="list-style-type: none"> Linear drive: A system which controls the θ-axis rotation by the linear movement. 
	Distance from rotation center to linear axis	0.0000 to 99,999.9999 [0.0000]	<p>For the linear drive system, set the distance (L) from the stage rotation center to the linear axis.</p> 
Camera movement axis	X-axis	<ul style="list-style-type: none"> Checked [Unchecked] 	Enable this setting when the camera moves instead of the stage axis.
	Y-axis	<ul style="list-style-type: none"> Checked [Unchecked] 	When this is disabled, a movement amount and so on is calculated on the premise that the stage moves.

*1. The name of parameters noted is when X-axis is selected as the movement axis. When Y-axis is selected, the notation is changed like below.

X-axis is selected as the Measurement axis	Y-axis is selected as the Measurement axis
Y-axis relative angle (X-axis standard)	X-axis relative angle (Y-axis standard)
Y-axis relative magnification (X-axis standard)	X-axis relative magnification (Y-axis standard)
X-axis limit	Y-axis limit

Set Parameters Depending on Each of Stage (X(Y) Stage)

Here sets X or Y stage that is 1-axis stage.

- 1 When selecting *X(Y) stage* in the *Stage type*, the *X(Y) stage setting* area is displayed. Set parameters in the *X(Y) stage setting* area.

Stage setting

Stage type:

Rotation polarity: Positive Negative

X(Y) stage setting

Movement axis: X-axis Y-axis

Coordinate: Lefthand Righthand

Y-axis relative angle(X-axis standard):

Y-axis relative magnification(X-axis standard):

X-axis limit: -

- 2 Select the type of stage for the *Movement axis* in the *X(Y) stage setting* area. Selecting *X-axis* is set to X stage, and selecting *Y-axis* is set to Y stage. The name of parameters in the *X(Y) stage setting* area will be changed by selecting *Movement axis*.*1

When you select [X-axis]

X(Y) stage setting

Movement axis: X-axis Y-axis

Coordinate: Lefthand Righthand

Y-axis relative angle(X-axis standard):

Y-axis relative magnification(X-axis standard):

X-axis limit: -

When you select [Y-axis]

X(Y) stage setting

Movement axis: X-axis Y-axis

Coordinate: Lefthand Righthand

X-axis relative angle(Y-axis standard):

X-axis relative magnification(Y-axis standard):

Y-axis limit: -

- 3 Select *Lefthand* or *Righthand* in the *Coordinate*.

The camera position direction is assumed as a Z-axis with respect to the plane on which the workpiece including the moving axis is placed. Viewed from the camera, the positive direction is clockwise to the lefthand system and the counterclockwise direction is the righthand system, select one of them.

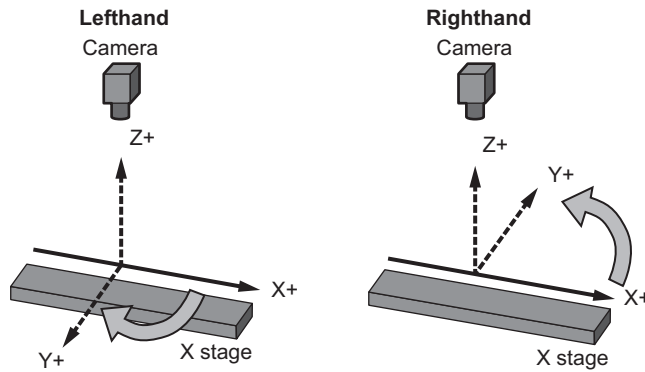

- 4** Click at the right side of *Y-axis relative angle (X-axis standard)* to set the relative angle for X-axis.*1

Sets an angle formed by Y-axis virtually set on calculation and X-axis. It is 90 degrees in the normal orthogonal coordinate system.

- 5** Click at the right side of *Y-axis relative magnification (X-axis standard)* to set the relative magnification for X-axis.*1

Sets the rate of a unit movement amount of Y-axis virtually set on calculation. It is 1 in the normal orthogonal coordinate system.

- 6** Click at the right side of *X-axis limit* to set the upper and lower limit values for the movement axis of X-axis.*1

Setting item	Setting value [Factory default]	Description
Movement axis	<ul style="list-style-type: none"> [X-axis] Y-axis 	Selects the type of stage. Selecting X-axis is set to Xθ stage and selecting Y-axis is set to Yθ stage.
Coordinate	<ul style="list-style-type: none"> [Lefthand] Righthand 	Sets the coordinate system to be used. <ul style="list-style-type: none"> Lefthand The clockwise is forward when setting the coordinates. Righthand The counter-clockwise is forward when setting the coordinates.
Y-axis relative angle (X-axis standard) <i>Set Parameters Depending on Each of Stage (X(Y) Stage) on page 4-288</i>	0.000001 to 180.000000 [90.000000]	X-axis selected: Sets a virtually calculated relative angle of Y-axis into X-axis. Y-axis selected: Sets a virtually calculated relative angle of X-axis into Y-axis. Unit: degree
Y-axis relative magnification <i>Set Parameters Depending on Each of Stage (X(Y) Stage) on page 4-288</i>	0.100000 to 9.999999 [1.000000]	X-axis selected: Sets a virtually calculated relative magnification of Y-axis into X-axis. Y-axis selected: Sets a virtually calculated relative magnification of X-axis into Y-axis.

Setting item	Setting value [Factory default]	Description
X-axis limitSet Parameters Depending on Each of Stage (X(Y) Stage) on page 4-288	-99,999.9999 to 99,999.9999 [-99,999.9999] to [99,999.9999]	X-axis selected: Sets the upper and lower limit values for the X-axis movement range. Y-axis selected: Sets the upper and lower limit values for the Y-axis movement range. The unit used is a coordinate system set in calibration.

*1. The name of parameters noted is when X-axis is selected as the movement axis. When Y-axis is selected, the notation is changed like below.

X-axis is selected as the Measurement axis	Y-axis is selected as the Measurement axis
Y-axis relative angle (X-axis standard)	X-axis relative angle (Y-axis standard)
Y-axis relative magnification (X-axis standard)	X-axis relative magnification (Y-axis standard)
X-axis limit	Y-axis limit

4-35-2 Measurement Results for Which Output Is Possible (Stage Data)

The following values can be output using processing items related to result output. It is also possible to reference measurement values from calculation expressions and other processing units.

Measurement items	Character string	Description
Judge	JG	Judgment results 0: No judgment (unmeasured) 1: Judgment result OK -1: Judgment result NG -10: Error (image format mismatch) -11: Error (unregistered model) -12: Error (insufficient memory) -20: Error (other errors)

4-35-3 External Reference Tables (Stage Data)

No.	Data name	Data ident	Set/Get	Data range
0	Judge	judge	Get only	0: No judgment (unmeasured), 1: Judgment result OK, -1: Judgment result NG,
120	Stage type	machineType	Set/Get	0: XY stage, 1: XY θ stage, 2: θ XY stage, 3: UVW stage, 4: UVWR stage, 5: X θ (Y θ) stage, 6: θ X(θ Y) stage, 7: X(Y) stage
121	Rotation polarity	rotationPolarValue	Set/Get	-1: Negative (Y-axis to X-axis direction), 1: Positive (X-axis to Y-axis direction)
122	Distance from rotation center to linear axis	centerPositionDist	Set/Get	0.000000 to 99,999.999999

No.	Data name	Data ident	Set/Get	Data range
123	Axis parameter setting	settingType	Set/Get	0: Setting by XY coordinates, 1: Setting by Polar coordinate system
124	Rotation center X	stageRotPosX	Set/Get	-99,999.999999 to 99,999.999999
125	Rotation center Y	stageRotPosY	Set/Get	-99,999.999999 to 99,999.999999
126	Fulcrum type	sliderType	Set/Get	0: Rotation, 1: Linear
127	θ -axis type	thetaType	Set/Get	0: Direct drive, 1: Linear drive
128	Camera movement axis X-axis	cameraMoveAxisX	Set/Get	0: Camera moving axis X is not used. 1: Camera moving axis X is used.
129	Camera movement axis Y-axis	cameraMoveAxisY	Set/Get	0: Camera moving axis Y is not used. 1: Camera moving axis Y is used.
130	R1	axisDistU	Set/Get	0.000000 to 99,999.999999
131	θ 1	axisAngleU	Set/Get	-360.000000 to 360.000000
132	R2	axisDistV	Set/Get	0.000000 to 99,999.999999
133	θ 2	axisAngleV	Set/Get	-360.000000 to 360.000000
134	R3	axisDistW	Set/Get	0.000000 to 99,999.999999
135	θ 3	axisAngleW	Set/Get	-360.000000 to 360.000000
136	R4	axisDistR	Set/Get	0.000000 to 99,999.999999
137	θ 4	axisAngleR	Set/Get	-360.000000 to 360.000000
150	UX	axisPosXU	Set/Get	-99,999.999999 to 99,999.999999
151	UY	axisPosYU	Set/Get	-99,999.999999 to 99,999.999999
152	VX	axisPosXV	Set/Get	-99,999.999999 to 99,999.999999
153	VY	axisPosYV	Set/Get	-99,999.999999 to 99,999.999999
154	WX	axisPosXW	Set/Get	-99,999.999999 to 99,999.999999
155	WY	axisPosYW	Set/Get	-99,999.999999 to 99,999.999999
156	RX	axisPosXR	Set/Get	-99,999.999999 to 99,999.999999
157	RY	axisPosYR	Set/Get	-99,999.999999 to 99,999.999999
170	U-axis direction	axisKindU	Set/Get	0: X-axis positive, 1: X-axis negative, 2: Y-axis positive, 3: Y-axis negative
171	V-axis direction	axisKindV	Set/Get	0: X-axis positive, 1: X-axis negative, 2: Y-axis positive, 3: Y-axis negative
172	W-axis direction	axisKindW	Set/Get	0: X-axis positive, 1: X-axis negative, 2: Y-axis positive, 3: Y-axis negative

No.	Data name	Data ident	Set/Get	Data range
173	R-axis direction	axisKindR	Set/Get	0: X-axis positive, 1: X-axis negative, 2: Y-axis positive, 3: Y-axis negative
180	Lower limit of X-axis movement	lowerMoveX	Set/Get	-99,999.9999 to 99,999.9999
181	Upper limit of X-axis movement	upperMoveX	Set/Get	-99,999.9999 to 99,999.9999
182	Lower limit of Y-axis movement	lowerMoveY	Set/Get	-99,999.9999 to 99,999.9999
183	Upper limit of Y-axis movement	upperMoveY	Set/Get	-99,999.9999 to 99,999.9999
184	Lower limit of θ -axis movement	lowerMoveTheta	Set/Get	-180 to 180
185	Upper limit of θ -axis movement	upperMoveTheta	Set/Get	-180 to 180
186	Lower limit of θ -axis(linear drive) movement	lowerMoveLinear-Theta	Set/Get	-99,999.9999 to 99,999.9999
187	Upper limit of θ -axis(linear drive) movement	upperMoveLinear-Theta	Set/Get	-99,999.9999 to 99,999.9999
190	Lower limit of U-axis movement	lowerMoveU	Set/Get	-99,999.9999 to 99,999.9999
191	Upper limit of U-axis movement	upperMoveU	Set/Get	-99,999.9999 to 99,999.9999
192	Lower limit of V-axis movement	lowerMoveV	Set/Get	-99,999.9999 to 99,999.9999
193	Upper limit of V-axis movement	upperMoveV	Set/Get	-99,999.9999 to 99,999.9999
194	Lower limit of W-axis movement	lowerMoveW	Set/Get	-99,999.9999 to 99,999.9999
195	Upper limit of W-axis movement	upperMoveW	Set/Get	-99,999.9999 to 99,999.9999
196	Lower limit of R-axis movement	lowerMoveR	Set/Get	-99,999.9999 to 99,999.9999
197	Upper limit of R-axis movement	upperMoveR	Set/Get	-99,999.9999 to 99,999.9999
300	Movement axis	moveAxis	Set/Get	0: X-axis, 1: Y-axis
301	Coordinate	coordinate	Set/Get	0: Lefthand, 1: Righthand
302	relative angle	relativeAngle	Set/Get	1.000000 to 179.000000
303	relative magnification	relativeScale	Set/Get	0.100000 to 9.999999

4-36 Conveyor Calibration

This processing item is specialized for the FH Sensor Controller, especially for conveyor tracking applications.

This item cannot be operated from an FH Sensor Controller User Interface. Use Sysmac Studio in that case.

For details, refer to *FH series Vision Sensor Conveyor Tracking Application Programming Guide (Cat. No. Z368)*.

Used in the Following Case

When calibrating camera, conveyor, and robot with the *Conveyor Calibration*.

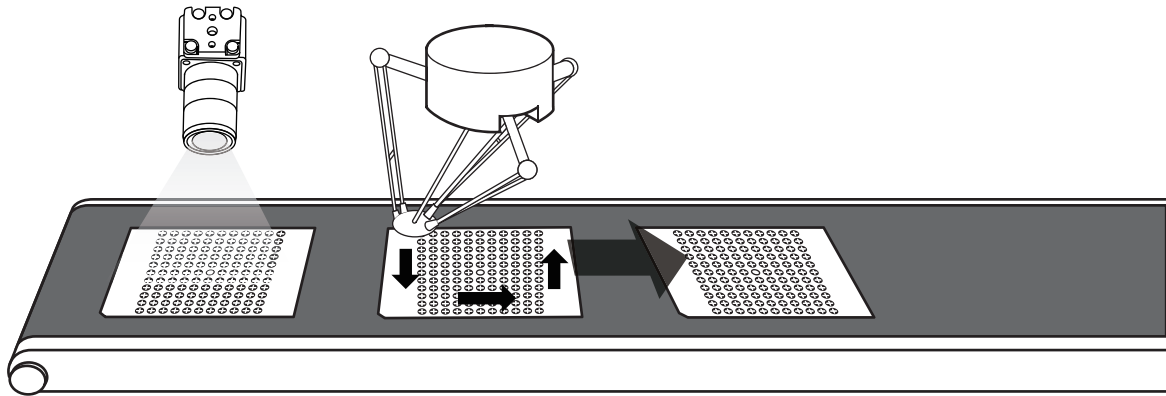

Precautions for Correct Use

In the measurement flow, if the processing unit that generates the calibration data is set after the processing unit that corrects the image, the output coordinates that can be acquired by the processing unit after the processing unit that generates the calibration data are only the coordinates after image correction.

4-37 Scene

This processing item defines frequently performed processing units in the measurement flow in a scene, and registers them to the measurement flow as the reference. Performing the parameter settings once by the defined processing unit reflects the settings to all processing units registered in the measurement flow.

Moreover, such reflection is also available from the measurement flow.

Used in the Following Case

When reducing the time for parameter settings for the same processing units frequently performed in the measurement flow without performing it individually.

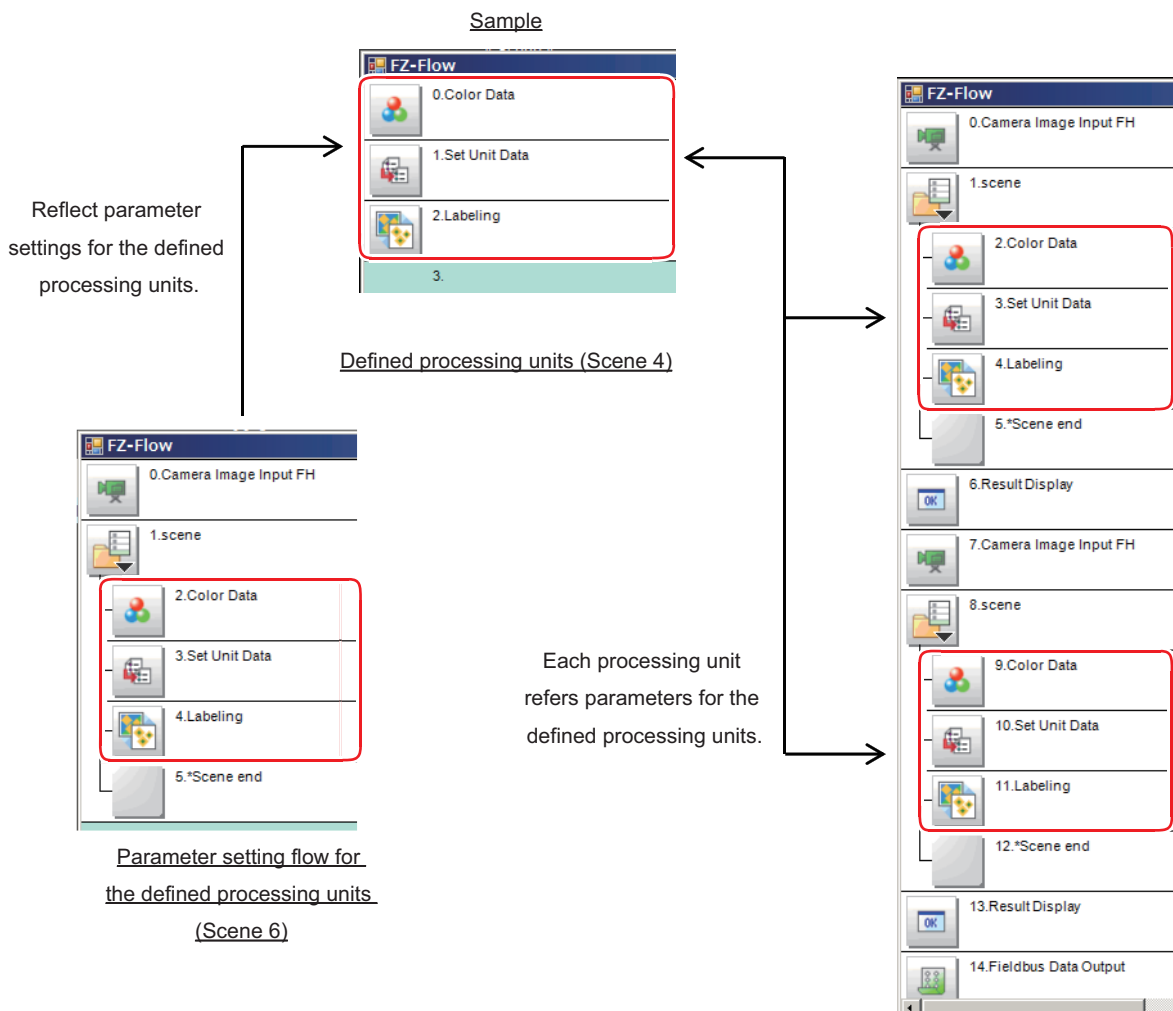



Precautions for Correct Use

- Since the processing unit being referenced as the data source is pulled in to the reference destination, application memory is consumed for it in each reference destination it is used in.
- Be sure to use *Scene* processing item and *Scene end* processing item as a pair.
- Avoid to refer to each other scene between *Scene* processing items.
- Avoid to refer to a scene in the measurement flow with the *Scene* processing item.
- Scene numbers which can be referenced using the *Scene* processing item are limited to them in the same scene group.
- Avoid to include the *Display Image Hold* processing item in the scene referenced with the *Scene* processing item. The stored images are cleared due to the flow reconstruction when switching scenes.
- If a scene not registered is selected using the *Scene* processing item, the reference is it cannot be referenced.
- If you use an operator to reference data between a processing unit within a *Scene* and one outside the *Scene*, it will not operate correctly.
- For the *Scene* processing item, do not use scene variables or system-defined variables as parameters. The data may not be read.

4-37-1 Scene Setting (Scene)

First, select scenes in the same scene group and define processing units which are repeatedly and frequently used in the measurement flow.

Second, create a flow for the setting and adjusting the defined processing items in another scene in the same scene group. In the flow, place a pair of *Scene* processing items and insert the defined processing units between the *Scene* processing items and then perform the setting and adjustment.

Lastly, create a measurement flow and place the *Scene* processing items and place the defined processing items between them.

Define Processing Units

Create a flow for processing units to be defined in the *Flow editing* window.

- 1 Click **Scene switch** on the *Tool* window in the *Main* screen to set the scene to use. In the example below, the scene 3 is used.

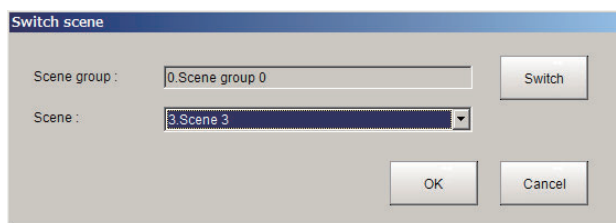

- 2 Click **Edit flow** on the *Tool* window in the *Main* screen.

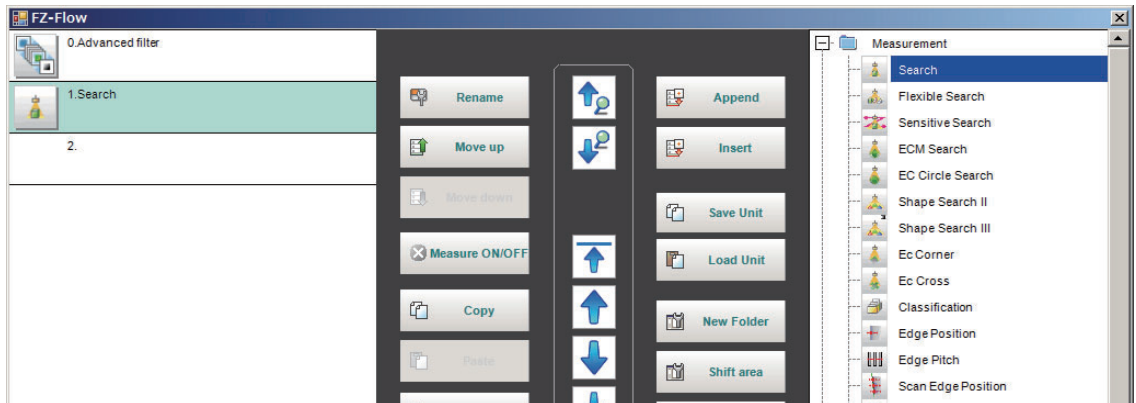

- 3 Click **Close** to return to the Main screen.

Create a Flow for Setting and Adjusting the Defined Processing Units

Create a flow for setting and adjusting the defined processing units in another scene in the same scene group. Use this scene when setting and adjusting the defined processing units.

- 1 Click **Scene switch** on the *Tool* window in the Main screen to set the scene to use. In the example below, the scene 5 is used.

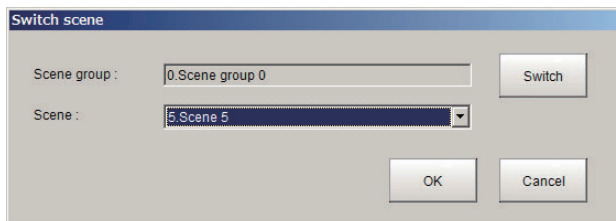

- 2 Click **Edit flow** on the *Tool* window in the *Main* screen to display the *Flow edit* screen.
- 3 Click **Append** or **Insert** to add the *Scene* processing item into the flow. The *Scene* processing unit and the *Scene end* processing unit are added into the flow as a pair.

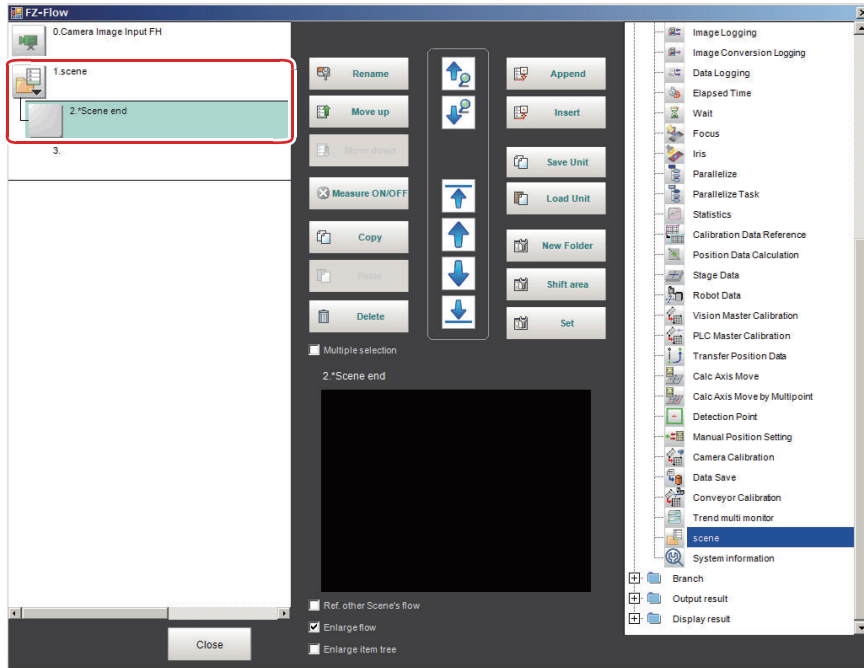

- 4** Select the *Scene* processing unit on the flow.
The *Scene* processing unit and the *Scene end* processing unit are selected together.

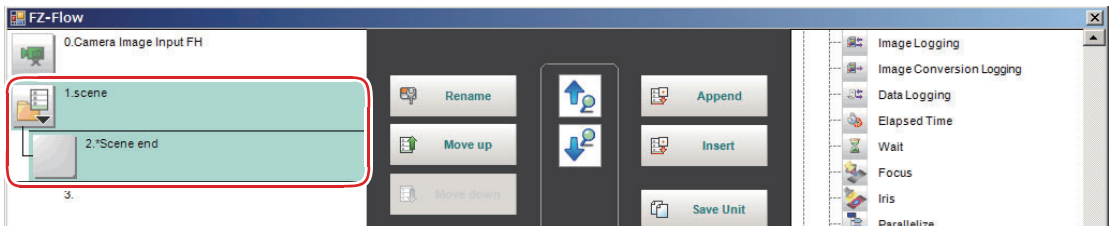

- 5** Click **Set**.
The *Scene* setting dialog is displayed.

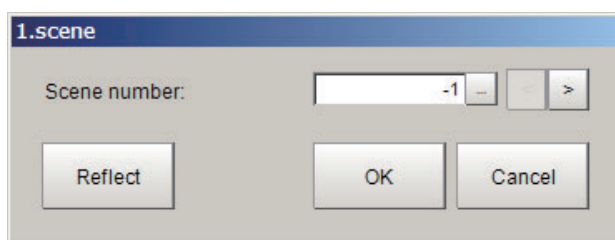

- 6** Input the scene number for the defined processing units in the *Scene number* and click **OK**.
The defined processing units are inserted between the *Scene* processing unit and *Scene end* processing unit.

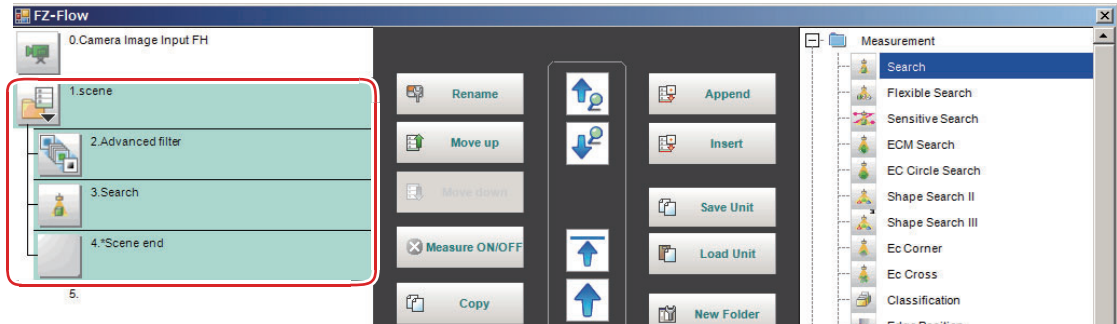

- 7 Click **Close** to return to the Main screen and measure and set parameters.
- 8 Select the *Scene* processing unit and click  at the upper right of the flow display window. As the *Scene* setting dialog is displayed, input the scene number for the defined processing units.

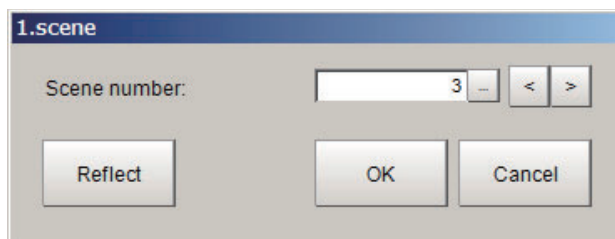

- 9 Click **Reflect**.
The set parameters are reflected in the defined processing units.
- 10 Click **OK**.
The setting and adjustment are completed.

Scene Setting

Create a measurement flow on another scene in the same scene group.

- 1 Click **Scene switch** on the *Tool* window in the Main screen to set the scene to use. In the example below, use the scene 0.

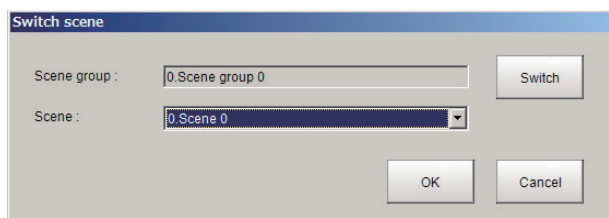

- 2 Click **Edit flow** on the *Tool* window in the *Main* screen to display the *Flow edit* screen.
- 3 Click **Append** or **Insert** to add the *Scene* processing item into the flow.

The *Scene* processing unit and the *Scene end* processing unit are added into the flow as a pair.

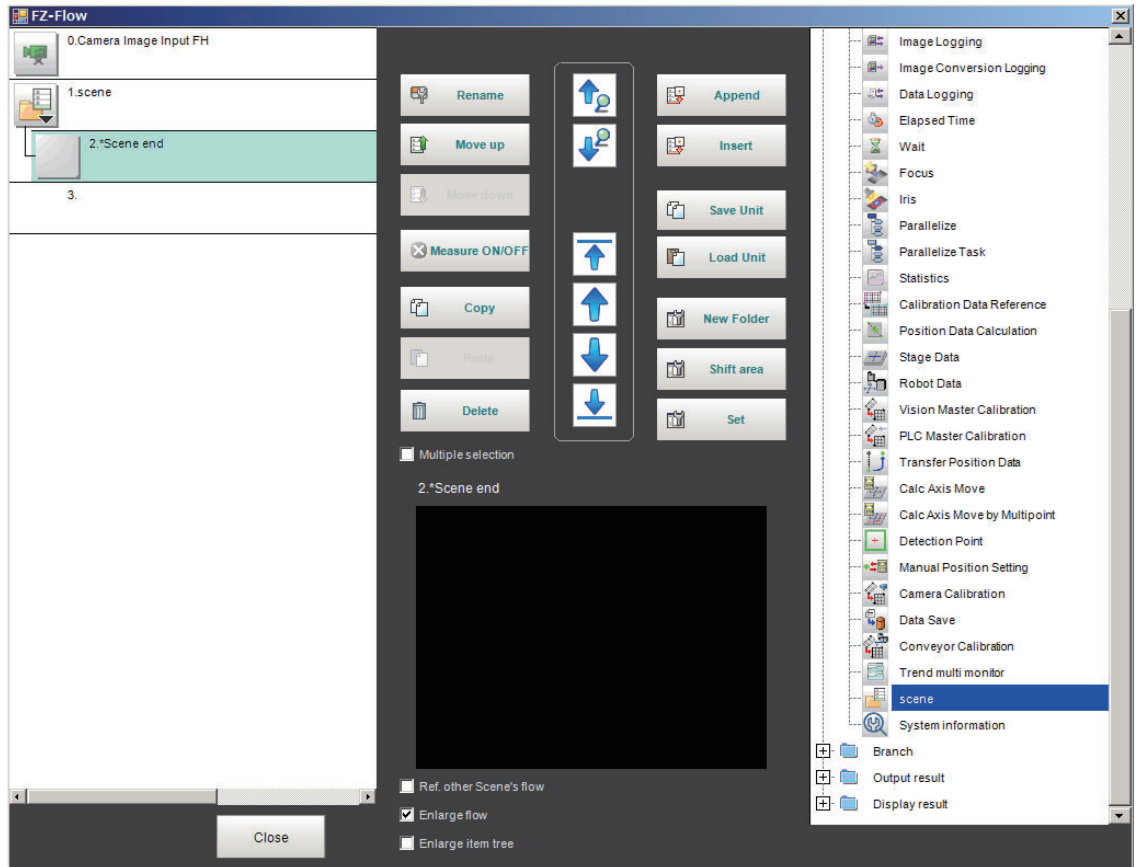

- 4** Select the *Scene* processing unit on the flow.
The *Scene* processing unit and the *Scene end* processing unit are selected together.

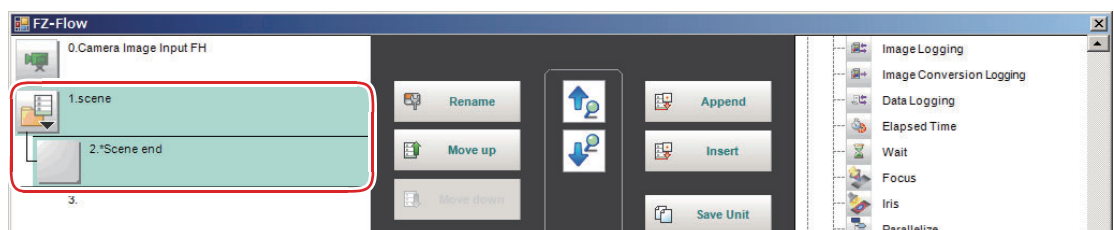

- 5** Click **Set**.
The *Scene* setting dialog is displayed.

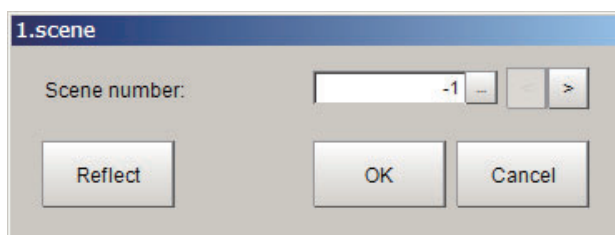

- 6** Input the scene number for the defined processing units in the *Scene number* and click **OK**.

The defined processing units are inserted between the *Scene* processing unit and *Scene end* processing unit.

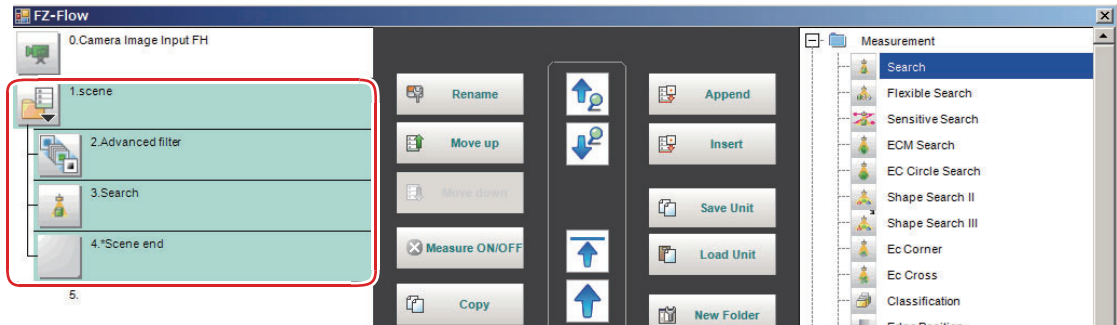

- 7 Create the measurement flow by repeating the same procedures.
- 8 Click **Close** to return to the Main screen.

Reflecting the Modified Settings on the Measurement Flow into the Setting and Adjustment Flow

Any modifications to the defined processing units between the *Scene* and *Scene end* processing items such as adding processing items, deleting processing units, or correcting parameters for each processing unit can be reflected in the reference source.



Precautions for Correct Use

If there are multiple scene processing items, after reflecting any modifications in a pair of *Scene* processing item and the *Scene end* processing items and then move to the next pair.

- 1 In the Flow edit screen, add processing items, delete processing units, or correct parameters for processing units between the *Scene* to *Scene end* processing units.
- 2 Select the *Scene* processing unit on the measurement flow.
The processing units between the *Scene* and *Scene end* processing units are selected.
- 3 Click **Set**.
- 4 The *Scene* setting dialog is displayed.

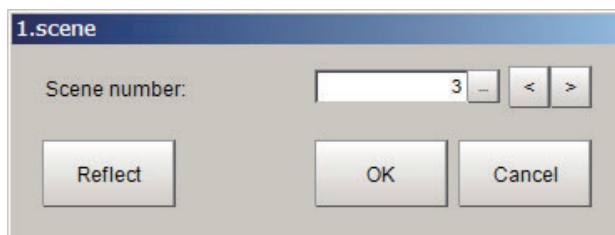

- 5 Click **Reflect**.
The modifications are reflected in the defined processing units.

- 6 Click **OK**.
- 7 When there are multiple *Scene* processing items, repeat step 1 to 6 accordingly.
- 8 After the modifications are completed, click **Close** to return to the Main screen.
- 9 Click **Data save** to save the modifications.

4-37-2 External Reference Tables (Scene)

No.	Data name	Data ident	Set/Get	Data range
None	Judge	judge	Get only	0: No judgment (unmeasured), 1: Judgment result OK, -1: Judgment result NG, -10: Error (image format mismatch), -11: Error (unregistered model), -12: Error (insufficient memory), -20: Error (other errors)
None	SceneNo	sceneNo	Set/Get	Specify sceneNo (-1: No setting)

4-38 System Information

This processing item gets the system information such as memory capacity, disk space, and/or I/O input signal status of the Sensor Controller.

You just add this item in the measurement flow without any settings.

Used in the Following Case

When acquiring system information such as memory capacity, disk space, and I/O input signal status of the Sensor Controller:

4-38-1 Usage

On the setting screen, the output parameters for System Information are displayed.

In the Variable column, you can assign the parameter you want to obtain using the variable.

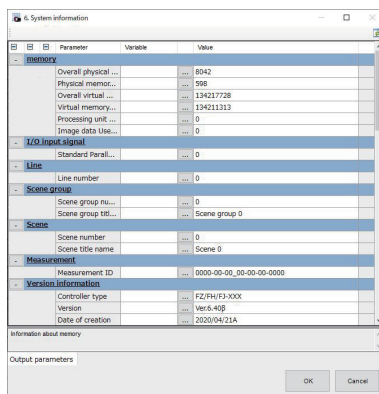

4-38-2 Available System Information (System information)

The available system information to be acquired is below and depends on models.

System information	Description
Memory	Information about memory
Overall physical memory size	Unit: MB
Physical memory usable size	Unit: MB
Overall virtual memory size	Unit: MB
Virtual memory usable size	Unit: MB
Processing unit data used size	Unit: MB
Image data used size	Unit: MB
I/O input signal	Information about I/O input signals
Standard Parallel I/O	The bit sum of the pin whose input signal is ON.
Line	Information about the line
Current Line Number	Number of the current line
Scene Group	Information about scene groups

System information		Description
	Scene Group Number	Number of the current scene group
	Scene Group Name	Title name of the current scene group
Scene		Information about the scene
	Scene Number	Number of the current scene
	Scene Name	Title name of the current scene
Measurement		Information about measurement
	Measurement ID	Measurement ID
Version Information		Version Information
	Controller Type	Controller Type
	Version	Application Software Version
	Date of Creation	Creation date of application software
Disk Capacity		Information about disk capacity
	Available size of drive C	Unit: MB
	Overall size of drive C	Unit: MB
	Free size of drive C	Unit: MB
	Available size of drive D	Unit: MB
	Overall size of drive D	Unit: MB
	Free size of drive D	Unit: MB
	Available size of drive E	Unit: MB
	Overall size of drive E	Unit: MB
	Free size of drive E	Unit: MB
	Available size of drive F	Unit: MB
	Overall size of drive F	Unit: MB
	Free size of drive F	Unit: MB
	Available size of drive M	Unit: MB
	Overall size of drive M	Unit: MB
	Free size of drive M	Unit: MB
	Available size of drive S	Unit: MB
	Overall size of drive S	Unit: MB
	Free size of drive S	Unit: MB
	Available size of drive T	Unit: MB
	Overall size of drive T	Unit: MB
	Free size of drive T	Unit: MB
	Available size of drive U	Unit: MB
	Overall size of drive U	Unit: MB
	Free size of drive U	Unit: MB
	Available size of drive V	Unit: MB
	Overall size of drive V	Unit: MB
	Free size of drive V	Unit: MB
	Available size of drive W	Unit: MB
	Overall size of drive W	Unit: MB
	Free size of drive W	Unit: MB
	Available size of drive X	Unit: MB
	Overall size of drive X	Unit: MB
Free size of drive X	Unit: MB	
Available size of drive Y	Unit: MB	
Overall size of drive Y	Unit: MB	

System information		Description
	Free size of drive Y	Unit: MB
	Available size of drive Z	Unit: MB
	Free size of drive Z	Unit: MB
	Overall size of drive Z	Unit: MB

4-38-3 External Reference Tables (System information)

No.	Data name	Data ident	Set/Get	Data range
None	Available size of drive X	disk.availableX	Get only	(Unit: MB)
None	Free size of drive W	disk.freeW	Get only	(Unit: MB)
None	Overall size of drive W	disk.totalW	Get only	(Unit: MB)
None	Overall size of drive X	disk.totalX	Get only	(Unit: MB)
None	Overall size of drive Y	disk.totalY	Get only	(Unit: MB)
None	Available size of drive Y	disk.availableY	Get only	(Unit: MB)
None	Free size of drive X	disk.freeX	Get only	(Unit: MB)
None	Free size of drive U	disk.freeU	Get only	(Unit: MB)
None	Overall size of drive U	disk.totalU	Get only	(Unit: MB)
None	Available size of drive U	disk.availableU	Get only	(Unit: MB)
None	Available size of drive V	disk.availableV	Get only	(Unit: MB)
None	Available size of drive W	disk.availableW	Get only	(Unit: MB)
None	Free size of drive V	disk.freeV	Get only	(Unit: MB)
None	Overall size of drive V	disk.totalV	Get only	(Unit: MB)
None	Scene title name	scene.title	Get only	Title name of the current scene
None	Scene number	scene.no	Get only	Number of the current scene
None	Scene group title name	sceneGroup.title	Get only	Title name of the current scene group
None	Measurement ID	measure.measureId	Get only	Measurement ID
None	Date of creation	version.date	Get only	Creation date of application software
None	Version	version.version	Get only	Application software version
None	Controller type	version.machine	Get only	Controller type
None	Overall size of drive Z	disk.totalZ	Get only	(Unit: MB)
None	Available size of drive Z	disk.availableZ	Get only	(Unit: MB)
None	Free size of drive Y	disk.freeY	Get only	(Unit: MB)
None	Free size of drive Z	disk.freeZ	Get only	(Unit: MB)

No.	Data name	Data ident	Set/Get	Data range
None	Scene group number	sceneGroup.no	Get only	Number of the current scene group
None	Line number	multiLine.no	Get only	Number of the current line
None	Standard Parallel I/O	io.Parallelo.GetAll	Get only	The bit sum of the pin whose input signal is ON
None	Free size of drive C	disk.freeC	Get only	(Unit: MB)
None	Overall size of drive C	disk.totalC	Get only	(Unit: MB)
None	Available size of drive C	disk.availableC	Get only	(Unit: MB)
None	Available size of drive D	disk.availableD	Get only	(Unit: MB)
None	Available size of drive E	disk.availableE	Get only	(Unit: MB)
None	Free size of drive D	disk.freeD	Get only	(Unit: MB)
None	Overall size of drive D	disk.totalD	Get only	(Unit: MB)
None	Physical memory usable size	memory.physicalA- available	Get only	(Unit: MB)
None	Overall physical memory size	memory.physicalTo- total	Get only	(Unit: MB)
None	Judge	judge	Get only	0: No judgment (unmeasured), 1: Judgment result OK, -1: Judgement result NG, -10: Error (image format mismatch), -11: Error (unregistered model), -12: Error (insufficient memory), -20: Error (other errors)
None	Overall virtual memory size	memory.virtualTotal	Get only	(Unit: MB)
None	Image data Used size	memory.imageUsed	Get only	(Unit: MB)
None	Processing unit data Used size	memory.procUnitUsed	Get only	(Unit: MB)
None	Virtual memory usable size	memory.virtualAvail- able	Get only	(Unit: MB)
None	Overall size of drive S	disk.totalS	Get only	(Unit: MB)
None	Available size of drive S	disk.availableS	Get only	(Unit: MB)
None	Free size of drive M	disk.freeM	Get only	(Unit: MB)
None	Free size of drive S	disk.freeS	Get only	(Unit: MB)
None	Free size of drive T	disk.freeT	Get only	(Unit: MB)
None	Overall size of drive T	disk.totalT	Get only	(Unit: MB)
None	Available size of drive T	disk.availableT	Get only	(Unit: MB)
None	Available size of drive F	disk.availableF	Get only	(Unit: MB)

No.	Data name	Data ident	Set/Get	Data range
None	Free size of drive E	disk.freeE	Get only	(Unit: MB)
None	Overall size of drive E	disk.totalE	Get only	(Unit: MB)
None	Overall size of drive F	disk.totalF	Get only	(Unit: MB)
None	Overall size of drive M	disk.totalM	Get only	(Unit: MB)
None	Available size of drive M	disk.availableM	Get only	(Unit: MB)
None	Free size of drive F	disk.freeF	Get only	(Unit: MB)

5

Branch

This chapter describes setting methods for when branch processing is performed.

5-1	Conditional Branch	5-3
5-1-1	List of Conditional Branch Items	5-4
5-1-2	Conditional Branch	5-4
5-1-3	Conditional Branch Settings Examples	5-5
5-1-4	Timeout (Conditional Branch)	5-7
5-1-5	Measurement Results for Which Output Is Possible (Conditional Branch).....	5-7
5-1-6	External Reference Tables (Conditional Branch)	5-8
5-2	End	5-9
5-3	DI Branch	5-11
5-3-1	Settings (DI Branch)	5-11
5-3-2	Timeout (DI Branch).....	5-12
5-3-3	Measurement Results for Which Output Is Possible (DI Branch)	5-13
5-3-4	External Reference Tables (DI Branch)	5-14
5-4	Control Flow Normal	5-16
5-4-1	Settings Flow (Control Flow Normal)	5-17
5-4-2	Settings (Control Flow Normal).....	5-17
5-4-3	Output Parameters (Control Flow Normal)	5-18
5-4-4	Key Points for Test Measurement and Adjustment (Control Flow Normal)...	5-19
5-4-5	Measurement Results for Which Output Is Possible (Control Flow Normal).....	5-19
5-4-6	External Reference Tables (Control Flow Normal)	5-19
5-5	Control Flow PLC Link	5-21
5-5-1	Settings Flow (Control Flow PLC Link)	5-22
5-5-2	Settings (Control Flow PLC Link).....	5-22
5-5-3	Output Parameters (Control Flow PLC Link)	5-23
5-5-4	Key Points for Test Measurement and Adjustment (Control Flow PLC Link).....	5-24
5-5-5	Measurement Results for Which Output Is Possible (Control Flow PLC Link).....	5-24
5-5-6	Timing Chart (Control Flow PLC Link)	5-24
5-5-7	External Reference Tables (Control Flow PLC Link)	5-26
5-6	Control Flow Parallel	5-27
5-6-1	Settings Flow (Control Flow Parallel).....	5-28
5-6-2	Settings (Control Flow Parallel)	5-28
5-6-3	Output Parameters (Control Flow Parallel).....	5-29
5-6-4	Key Points for Test Measurement and Adjustment (Control Flow Parallel) ..	5-30

5-6-5	Measurement Results for Which Output Is Possible (Control Flow Parallel)	5-30
5-6-6	External Reference Tables (Control Flow Parallel)	5-31
5-7	Control Flow Fieldbus.....	5-32
5-7-1	Settings Flow (Control Flow Fieldbus)	5-33
5-7-2	Settings (Control Flow Fieldbus).....	5-33
5-7-3	Output Parameters (Control Flow Fieldbus)	5-34
5-7-4	Key Points for Test Measurement and Adjustment (Control Flow Fieldbus).....	5-35
5-7-5	Measurement Results for Which Output Is Possible (Control Flow Fieldbus).....	5-35
5-7-6	Timing Chart (Control Flow Fieldbus)	5-35
5-7-7	External Reference Tables (Control Flow Fieldbus)	5-38
5-8	Selective Branch	5-39
5-8-1	Selective Branch (Selective Branch)	5-40
5-8-2	Output Parameters (Selective Branch)	5-41
5-8-3	Timeout (Selective Branch).....	5-41
5-8-4	Key Points for Test Measurement and Adjustment (Selective Branch)	5-42
5-8-5	Measurement Results for Which Output Is Possible (Selective Branch)	5-43
5-8-6	External Reference Tables (Selective Branch)	5-44
5-9	Conditional Execution (If).....	5-45
5-9-1	Conditional Execution Settings (Conditional Execution (If))	5-45
5-9-2	External Reference Tables (Conditional Execution (If))	5-49
5-10	Conditional Execution (Else).....	5-50
5-10-1	Conditional Execution Settings (Conditional Execution (Else))	5-50
5-10-2	External Reference Tables (Conditional Execution (Else))	5-54
5-11	Loop.....	5-55
5-11-1	Loop detail settings (Loop)	5-56
5-11-2	External Reference Tables (Loop)	5-58
5-12	Loop Interrupt.....	5-59
5-12-1	Loop Interrupt Settings (Loop Interrupt).....	5-60
5-12-2	External Reference Tables (Loop suspension)	5-60
5-13	Select Execution (Select)	5-61
5-13-1	Select Execution Setting (Select Execution (Select))	5-62
5-13-2	External Reference Tables (Select execution (Select))	5-64
5-14	Select Execution (Case)	5-65
5-14-1	Select Execution Setting (Select Execution (Case)).....	5-65
5-14-2	External Reference Tables (Select execution (Case))	5-68

5-1 Conditional Branch

This processing item is not available in the FHV series.

This processing item performs a comparative calculation using calculation expressions and conditions and branches the processing for subsequent items according to the calculation results.

Used in the Following Case

When applying optimum inspection respectively to two or more types of products flowing on the production line:

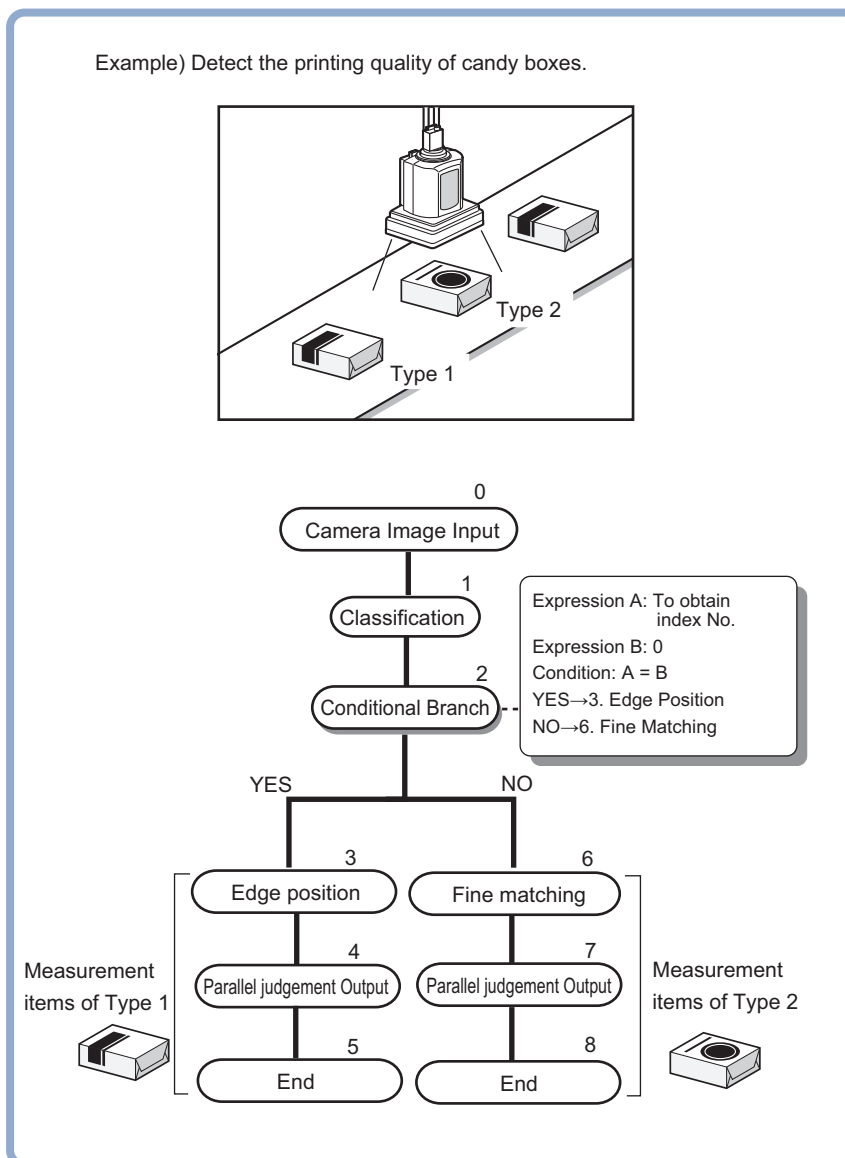

5-1-1 List of Conditional Branch Items

Setting item	Set value [Factory default]	Description
Condition	<ul style="list-style-type: none"> • [A = B] • A ≤ B • A < B • A ≥ B • A > B 	Selects the evaluation method for the expression A and B. Two data obtained from the conditional expressions are compared.
Expression A	Up to 256 characters	Sets the evaluation expression that will be the branching basis. the expression is set with calculation. For details, refer to 5-1-2 <i>Conditional Branch</i> on page 5-4.
Expression B		
Destination unit	YES	0 to 9,999: unit No. -1: [End processing]
	NO	0 to 9,999: unit No. -1: [End processing]

5-1-2 Conditional Branch

Specify the expression A and B for the branching conditions.

- Specify the expression A and B respectively.
For details, refer to 4-3-3 *Layout of Setting Expression Window (Calculation)* on page 4-12.

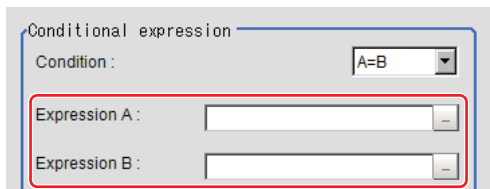

- Click ▼ at the *Condition* to set the conditions.

Condition	Condition
A=B	When the value of the expression A equals that of the expression B, the flow branches to the unit in which the <i>Destination unit</i> is YES. Otherwise, the flow branches to the NO unit.
A<=B	When the value of the expression A is equal to or smaller than that of the expression B, the flow branches to the unit in which the <i>Destination unit</i> is YES. Otherwise, the flow branches to the NO unit.
A<B	When the value of the expression A is smaller than that of the expression B, the flow branches to the unit in which the <i>Destination unit</i> is YES. Otherwise, the flow branches to the NO unit.
A>=B	When the value of the expression A is equal to or bigger than that of the expression B, the flow branches to the unit in which the <i>Destination unit</i> is YES. Otherwise, the flow branches to the NO unit.
A>B	When the value of the expression A is bigger than that of the expression B, the flow branches to the unit in which the <i>Destination unit</i> is YES. Otherwise, the flow branches to the NO unit.

3 Set the branch destination.



Precautions for Correct Use

- To avoid to loop in measurement processing, the branch destination should be selected to a processing unit thereafter this processing unit.
- Be sure to set *End* as the last processing unit at the branch destination to indicate the end of the branch.
For details, refer to 5-2 *End* on page 5-9.
- Avoid setting *Camera Image Input* of the processing unit 0 as the branch destination due to images improperly to be loaded.

Destination unit :

YES : 2.Search

NO : (End processing)



Additional Information

- The judgement result of a processing unit is determined at the timing when the processing unit was processed.
- The overall judgement is determined at the timing when the measurement for all processing units was completed.

5-1-3 Conditional Branch Settings Examples

By acquiring the overall judgement results for the processing units until the unit number in which the expression was set, branch the flow according to it.

Ex.: When branching the measurement process according to the overall judgement results for the unit 0 to 4:

Sample Display

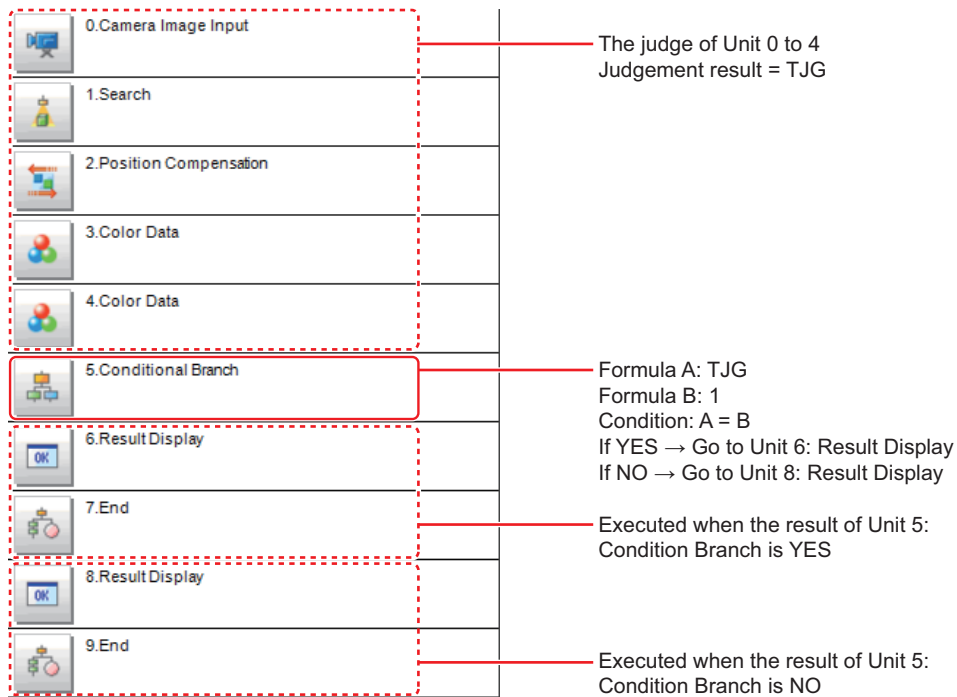

1 Set Conditional Branch in unit 5 and set the following expressions in the Expression A and B respectively.

- Expression A: TJG

Acquires the overall judgement results for unit 0 to 4. The overall results are output in the following manner according to the judgement results for unit 0 to 4.

Results of unit 0 to unit 4	TJG output
All the unit's judgement results are OK	1
The judgement results of one or more units are NG	-1

- Expression B: 1

Sets the value to be compared with the value of the expression A (TJG value).

2 Set the condition of the conditional expression to $A = B$.

As $A=B$, which means $TJG = 1$, is set the condition, when all judgement result for unit 0 to 4 are OK, the condition judgement results will be *YES*.

3 Set the branch destination respectively.

In the case of *YES*: Branch to unit 6, In the case of *NO*: Branch to unit 8.



Precautions for Correct Use

Parameters for units to which do not pass through at the conditional branch:

The judgement results at the time of the previous conditional branch, other than the judgement result (JG) of units, are maintained. The judgement result (JG) for units to which did not branch at the conditional branch becomes *No judgement (unmeasured)*. The judgement result (JG) however will be set to the unmeasured state at the time of all measurement processing completed. During the flow processing, the previous judgement result (JG) is maintained.

5-1-4 Timeout (Conditional Branch)

Set the conditions for the timeout of branch processing.

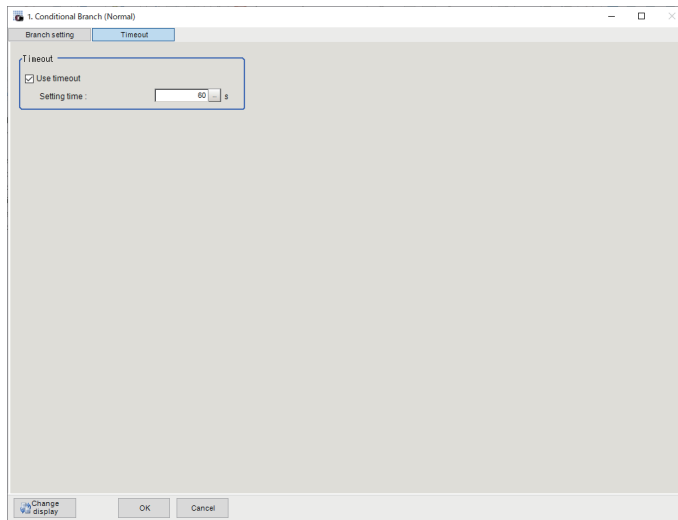

- 1 In the Item Tab area, click **Timeout**.
- 2 In the Timeout area, set each item.

Setting item	Setting value [Factory default]	Description
Use timeout	<ul style="list-style-type: none"> • [Checked] • Unchecked 	Places a check here to time out the branch processing after passing the specified time.
Setting time	1 to 3,600 [60]	<p>This is enabled when the <i>Use timeout</i> is checked.</p> <p>Sets the time in seconds until the measurement processing is timed out on this processing unit.</p> <p>When the measurement processing for this unit was performed, it will be timed out when the time from the measurement start exceeded the <i>Setting time</i>. When the measurement processing was timed out, the judgment result becomes NG.</p>



Precautions for Correct Use

- Normally, the *Use timeout* should be checked. If it were unchecked, a measurement flow can fall into infinite loop depending on the settings for the *Conditional Branch*.
- When using the *Conditional Branch* in a block of the parallelization task in the measurement flow, set it that branches occur only within the block. If the branches occurred across the blocks of the parallelization task, the timeout may not function properly even if the *Use timeout* were checked.

5-1-5 Measurement Results for Which Output Is Possible (Conditional Branch)

The following values can be output using processing items related to result output. It is also possible to reference measurement values from calculation expressions and other processing units.

Measurement items	Character string	Description
Judge	JG	Judgment results 0: No judgment (unmeasured) 1: Judgment result OK -1: Judgment result NG -10: Error (image format mismatch) -11: Error (unregistered model) -12: Error (insufficient memory) -20: Error (other errors)
Result of expression A	D0	Operation result of expression A
Result of expression B	D1	Operation result of expression B
Comparison result	RS	Compared result of the expressions (0: NO, 1: YES)
Destination unit No.	BU	Destination unit number based on the compared result of the expressions

5-1-6 External Reference Tables (Conditional Branch)

No.	Data name	Data ident	Set/Get	Data range
0	Judge	judge	Get only	0: No judgment (unmeasured), 1: Judgment result OK, -1: Judgment result NG, -10: Error (image format mismatch), -11: Error (unregistered model), -12: Error (insufficient memory), -20: Error (other errors)
5	Expression A result	resultExpA	Get only	Maximum 256 characters (result of calculation selected in expression A)
6	Expression B result	resultExpB	Get only	Maximum 256 characters (result of calculation selected in expression B)
7	Comparison result	judgeExpression	Get only	0: NO, 1: YES
8	Destination unit No.	branchUnitNo	Get only	0 to 9,999
120	Condition type	conditionType	Set/Get	0: A = B, 1: A <= B, 2: A < B, 3: A >= B, 4: A > B
121	Yes branch destination unit No.	unitBranchOK	Set/Get	-1: End processing 0 to 9,999: Unit No.
122	No branch destination unit No.	unitBranchNG	Set/Get	-1: End processing 0 to 9,999: Unit No.
123	Expression A	expressionA	Set/Get	Exp. character string
124	Expression B	expressionB	Set/Get	Exp. character string
125	Timeout	timeout	Set/Get	0: Not used, 1: Used
126	Timeout time[s]	timeoutTime	Set/Get	1 to 3,600

5-2 End

Just add this processing item in a scene. No operations such as condition settings are necessary. Please set this at the last unit of each branch.

Used in the Following Case

When ending the processing after branch:

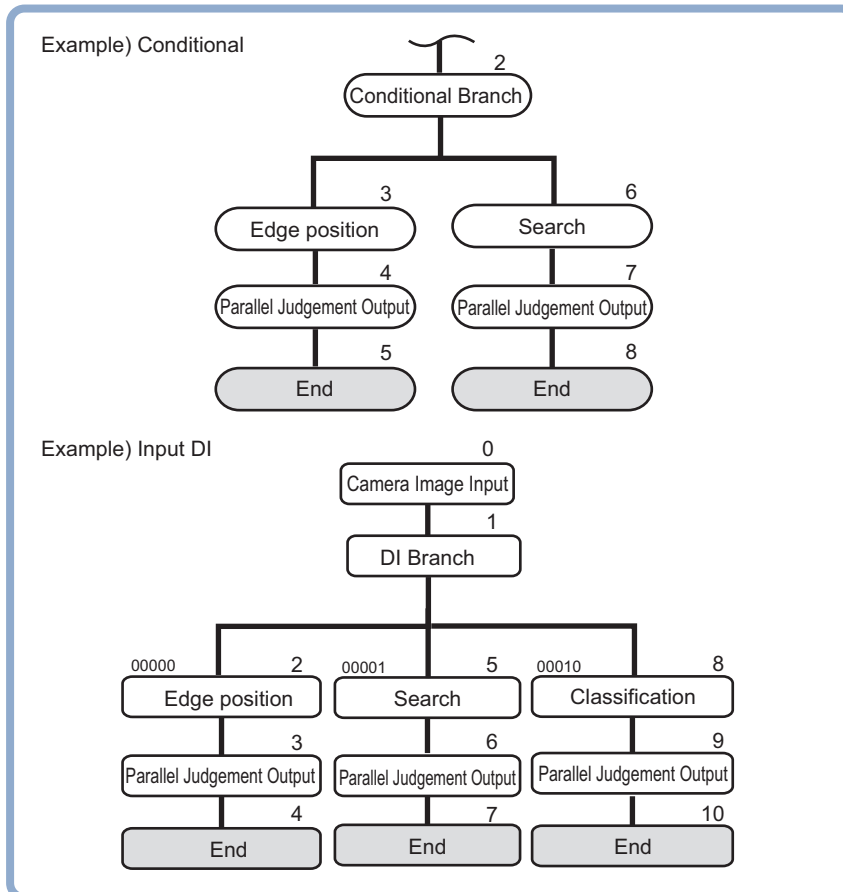



Additional Information

If the *End* processing item were not set at the end of a branch destination in the scene, even if a processing has been ended at a branch, the processing moves to next unit number in the scene.

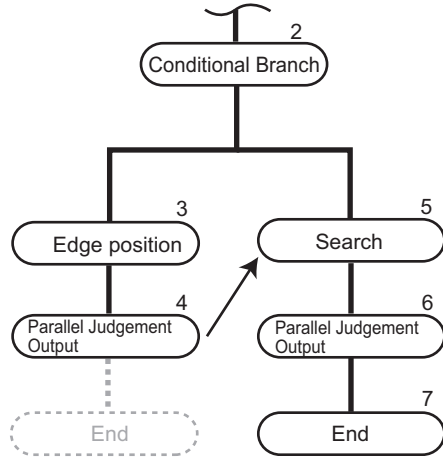

5-3 DI Branch

This processing item is not available in the FHV series.

This processing item branches subsequent processing units according to the information input from DI0 to 4 on the terminal block. Up to 32 branch destinations can be set.

Used in the Following Case

When applying different inspections to products on one production line according to a time band:

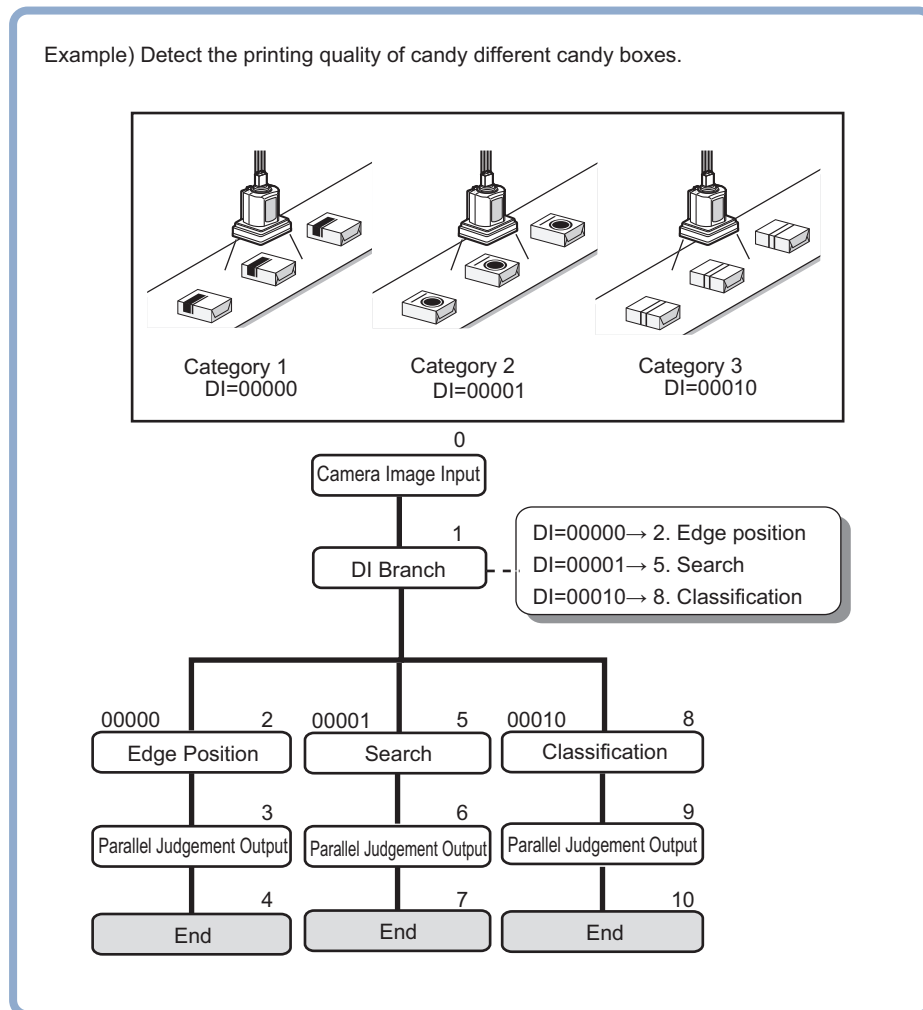

5-3-1 Settings (DI Branch)

Select the branch destination unit. Set it according to the information input in DI.

- 1 In the Item Tab area, click **Setting**.
- 2 From the input signal list, click the DI input to set the branch destination.
- 3 In the **Destination unit** area, click to set the branch destination unit.

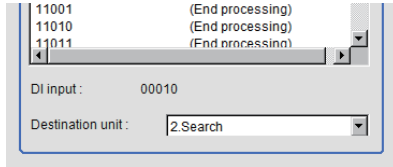

Precautions for Correct Use

- To avoid looping the measurement processing, the branch destination must be specified in the subsequent unit number from the *DI Branch*.
- Be sure to place the *End* processing unit at the end of the branch destination to indicate the end of the branch.
For details, refer to the 5-2 *End* on page 5-9
- When the operation mode in the FH series is set to *Multi-line random-trigger mode*, the DI input functions as follows.
Line 0: Follows DI0 and DI1 input status.
Line 1: Follows DI2 and DI3 input status.
Avoid setting the *DI branch* processing unit in Line 2 and later. The operation is unexpected. The behavior is undefined.

- 4** Repeat the step 2 to 3, and set the branch destination units in other input signals too.



Precautions for Correct Use

- Up to 32 branch destinations can be set.
- The Sensor Controller refers to the DI signals when the measurement for the *DI Branch* is performed.

- 5** Click **OK**.
The settings are completed.

5-3-2 Timeout (DI Branch)

Set the conditions for the timeout of branch processing.

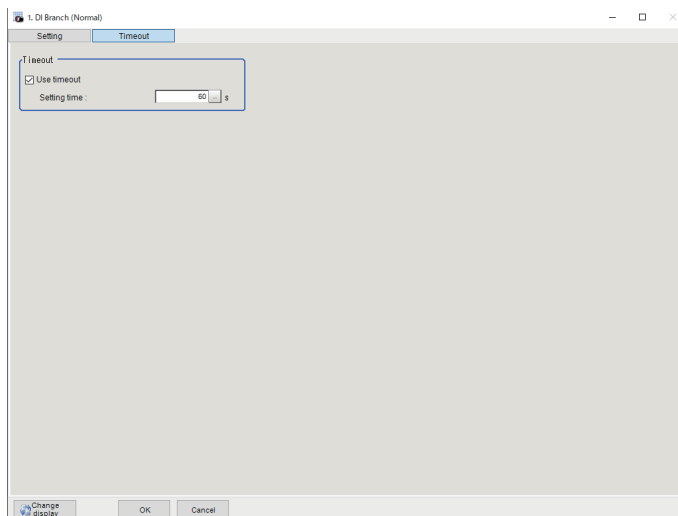

- 1** In the Item Tab area, click **Timeout**.

2 In the Timeout area, set each item.

Setting item	Setting value [Factory default]	Description
Use timeout	<ul style="list-style-type: none"> • [Checked] • Unchecked 	Places a check here to time out the DI branch processing after passing the specified time.
Setting time	1 to 3,600 [60]	<p>This is enabled when the <i>Use timeout</i> is checked.</p> <p>Sets the time in seconds until the measurement processing is timed out on this processing unit.</p> <p>When the measurement processing for this unit was performed, it will be timed out when the time from the measurement start exceeded the <i>Setting time</i>. When the measurement processing was timed out, the judgment result becomes NG.</p>



Precautions for Correct Use

- Normally, the *Use timeout* should be checked. If it were unchecked, a measurement flow can fall into infinite loop depending on the settings for the *Conditional Branch*.
- When using the *Conditional Branch* in a block of the parallelization task in the measurement flow, set it that branches occur only within the block. If the branches occurred across the blocks of the parallelization task, the timeout may not function properly even if the *Use timeout* were checked.

5-3-3 Measurement Results for Which Output Is Possible (DI Branch)

The following values can be output using processing items related to result output. It is also possible to reference measurement values from calculation expressions and other processing units.

Measurement items	Character string	Description
Judge	JG	Judgment results 0: No judgment (unmeasured) 1: Judgment result OK -1: Judgment result NG -10: Error (image format mismatch) -11: Error (unregistered model) -12: Error (insufficient memory) -20: Error (other errors)
DI input No.	DI	Number (decimal) corresponding to DI input (00000 to 11111)
Destination Unit No.	BU	Destination unit number corresponding to DI input

5-3-4 External Reference Tables (DI Branch)

No.	Data name	Data ident	Set/Get	Data range
0	Judge	judge	Get only	0: No judgment (unmeasured), 1: Judgment result OK, -1: Judgment result NG, -10: Error (image format mismatch), -11: Error (unregistered model), -12: Error (insufficient memory), -20: Error (other errors)
5	DI input No.	inputDIIno	Get only	No. used to indicate DI input (00000 to 11111)
6	Unit No.	branchUnitNo	Get only	0 to 9,999
120	Destination Unit No. 0 (DI input 00000)	unitBranch0	Set/Get	-1: End processing 0 to 9,999: Unit No.
121	Destination Unit No. 1 (DI input 00001)	unitBranch1	Set/Get	-1: End processing 0 to 9,999: Unit No.
122	Destination Unit No. 2 (DI input 00010)	unitBranch2	Set/Get	-1:End processing 0 to 9,999: Unit No.
123	Destination Unit No. 3 (DI input 00011)	unitBranch3	Set/Get	-1: End processing 0 to 9,999: Unit No.
124	Destination Unit No. 4 (DI input 00100)	unitBranch4	Set/Get	-1: End processing 0 to 9,999: Unit No.
125	Destination Unit No. 5 (DI input 00101)	unitBranch5	Set/Get	-1: End processing 0 to 9,999: Unit No.
126	Destination Unit No. 6 (DI input 00110)	unitBranch6	Set/Get	-1: End processing 0 to 9,999: Unit No.
127	Destination Unit No. 7 (DI input 00111)	unitBranch7	Set/Get	-1: End processing 0 to 9,999: Unit No.
128	Destination Unit No. 8 (DI input 01000)	unitBranch8	Set/Get	-1: End processing 0 to 9,999: Unit No.
129	Destination Unit No. 9 (DI input 01001)	unitBranch9	Set/Get	-1: End processing 0 to 9,999: Unit No.
130	Destination Unit No. 10 (DI input 01010)	unitBranch10	Set/Get	-1: End processing 0 to 9,999: Unit No.
131	Destination Unit No. 11 (DI input 01011)	unitBranch11	Set/Get	-1: End processing 0 to 9,999: Unit No.
132	Destination Unit No. 12 (DI input 01100)	unitBranch12	Set/Get	-1: End processing 0 to 9,999: Unit No.
133	Destination Unit No. 13 (DI input 01101)	unitBranch13	Set/Get	-1: End processing 0 to 9,999: Unit No.
134	Destination Unit No. 14 (DI input 01110)	unitBranch14	Set/Get	-1: End processing 0 to 9,999: Unit No.
135	Destination Unit No. 15 (DI input 01111)	unitBranch15	Set/Get	-1: End processing 0 to 9,999: Unit No.
136	Destination Unit No. 16 (DI input 10000)	unitBranch16	Set/Get	-1: End processing 0 to 9,999: Unit No.
137	Destination Unit No. 17 (DI input 10001)	unitBranch17	Set/Get	-1: End processing 0 to 9,999: Unit No.
138	Destination Unit No. 18 (DI input 10010)	unitBranch18	Set/Get	-1: End processing 0 to 9,999: Unit No.

No.	Data name	Data ident	Set/Get	Data range
139	Destination Unit No. 19 (DI input 10011)	unitBranch19	Set/Get	-1: End processing 0 to 9,999: Unit No.
140	Destination Unit No. 20 (DI input 10100)	unitBranch20	Set/Get	-1: End processing 0 to 9,999: Unit No.
141	Destination Unit No. 21 (DI input 10101)	unitBranch21	Set/Get	-1: End processing 0 to 9,999: Unit No.
142	Destination Unit No. 22 (DI input 10110)	unitBranch22	Set/Get	-1: End processing 0 to 9,999: Unit No.
143	Destination Unit No. 23 (DI input 10111)	unitBranch23	Set/Get	-1: End processing 0 to 9,999: Unit No.
144	Destination Unit No. 24 (DI input 11000)	unitBranch24	Set/Get	-1: End processing 0 to 9,999: Unit No.
145	Destination Unit No. 25 (DI input 11001)	unitBranch25	Set/Get	-1: End processing 0 to 9,999: Unit No.
146	Destination Unit No. 26 (DI input 11010)	unitBranch26	Set/Get	-1: End processing 0 to 9,999: Unit No.
147	Destination Unit No. 27 (DI input 11011)	unitBranch27	Set/Get	-1: End processing 0 to 9,999: Unit No.
148	Destination Unit No. 28 (DI input 11100)	unitBranch28	Set/Get	-1: End processing 0 to 9,999: Unit No.
149	Destination Unit No. 29 (DI input 11101)	unitBranch29	Set/Get	-1: End processing 0 to 9,999: Unit No.
150	Destination Unit No. 30 (DI input 11110)	unitBranch30	Set/Get	-1: End processing 0 to 9,999: Unit No.
151	Destination Unit No. 31 (DI input 11111)	unitBranch31	Set/Get	-1: End processing 0 to 9,999: Unit No.
200	Timeout	timeout	Set/Get	0: Not used, 1: Used
201	Timeout time[s]	timeoutTime	Set/Get	1 to 3,600

5-4 Control Flow Normal

This processing item is not available in the FHV series.

This processing item put the measurement flow currently performed into a wait state, and enable a specific communication command from an external device to be performed.

Used in the Following Case

When performing a communication command while processing a measurement flow:

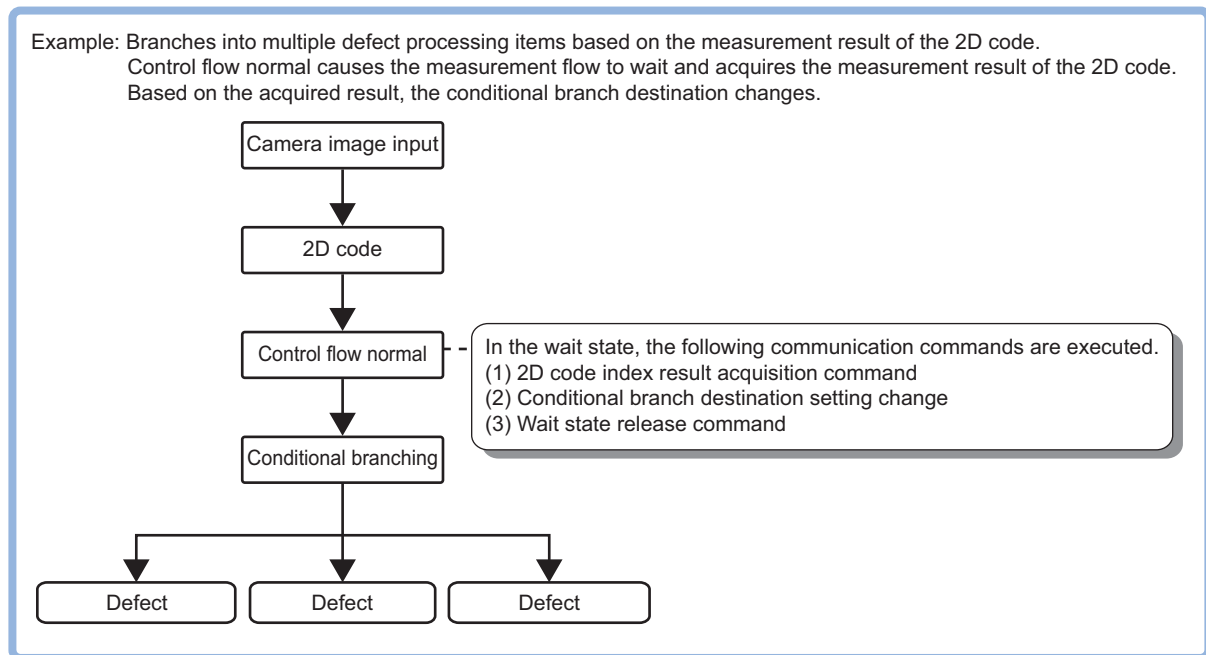

This processing item corresponds to the measurement flow control using the following communication modules.

Parallel	PLC Link	EtherNet/IP	EtherCAT	Non-procedure* ¹
-	-	-	-	OK

*1. Unless the communication module is non-procedure (UDP) (Fxxx series), or non-procedure (Fxxx series).

During the wait state, the communication commands below can be executed. For details about the communication commands, refer to the *Appendixes: Command Control - Command List* in the *Vision System FH/FHV Series User's Manual for Communications Settings (Cat. No. Z342)*.

Command name	Function
Get Unit Data	Gets the parameters and measurement values of processing units.
Set Unit Data	Sets the parameters and measurement values to processing units.
Return to Start of Flow	Branches to the start of the measurement flow (processing unit 0).

To clear the wait state, use the *Set Unit Data* command. By setting *1* to the *Wait state clear command* in the external reference table, the wait state can be cleared. For details, refer to the *5-4-6 External Reference Tables (Control Flow Normal)* on page 5-19.

5-4-1 Settings Flow (Control Flow Normal)

To set Control Flow Normal, follow the steps below.

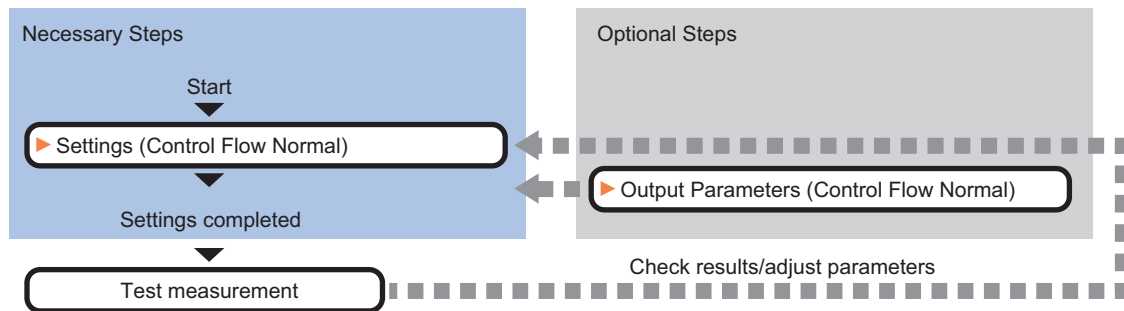

List of Control Flow Normal Items

Item	Description
Setting	Sets communication and timeout conditions for controlling the measurement flow.
Output parameter	Sets this to change the output parameters. Set the conditions and parameters to output measurement results to other processing units or external devices as the output parameters.

5-4-2 Settings (Control Flow Normal)

Set conditions for communications and timeout to control the measurement flow.

- 1 In the Item Tab area, click **Setting**.

- 2 In the Communication method area, select the item.

Setting item	Setting value [Factory default]	Description
Communication method	<ul style="list-style-type: none"> • [RS-232C / RS-422] • Ethernet 	Selects the communication method to control the measurement flow from an external device. *1

*1. RS-422 is unavailable in the FH/FHV series.

3 In the Timeout area, set each item.

Setting item	Setting value [Factory default]	Description
Use timeout	<ul style="list-style-type: none"> • [Checked] • Unchecked 	Places a check here when clearing the wait state after a specified time passed. Normally, place a check this to use.
Setting time	0 to 120,000 [5,000]	This is enabled when <i>Use timeout</i> is checked. Specifies the time in ms until the wait state set by this processing unit is cleared. When the timeout is used, the wait state is cleared after the time set in the <i>Setting time</i> passed from the start of measurement processing of this processing unit. The measurement flow resumes after the wait state was cleared.
Unit judgment in timeout	<ul style="list-style-type: none"> • [NG] • OK 	This is enabled when <i>Use timeout</i> is checked. Selects whether to set OK or NG as the judgment result of this processing unit when this processing unit was timed out in the measurement processing after the "Setting time" elapsed.



Precautions for Correct Use

Normally, the *Use timeout* should be checked. If it were unchecked, the wait state can be cleared only by transmitting the *Wait state clear command* from an external device.

5-4-3 Output Parameters (Control Flow Normal)

Set this item to change the output parameters.

As the output parameters, set the conditions and parameters to output measurement results to other processing units and external devices. Normally, the factory default values can be used.

1 In the Item Tab area, click **Output parameter**.

2 Select the item.

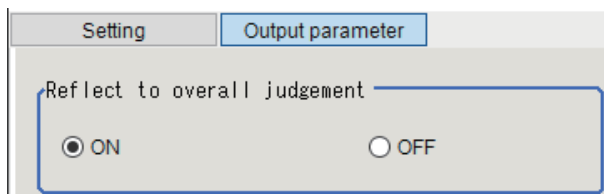

Setting item	Setting value [Factory default]	Description
Reflect to overall judgment	<ul style="list-style-type: none"> • [ON] • OFF 	Enables choosing whether or not the judgment results of this processing unit is reflected in the scene overall judgment.

5-4-4 Key Points for Test Measurement and Adjustment (Control Flow Normal)

The following content is displayed in the *Detail result* area as text.

Displayed item	Description
Judge	Judgment results 0: No judgment (unmeasured) 1: Judgment result OK -1: Judgment result NG -10: Error (image format mismatch) -11: Error (unregistered model) -12: Error (insufficient memory) -20: Error (other errors)

The image specified in the Sub-image number in the image display setting is displayed in the *Image Display* area.

Sub-image number	Description of image to be displayed
0	Measurement image

5-4-5 Measurement Results for Which Output Is Possible (Control Flow Normal)

The following values can be output using processing items related to result output. It is also possible to reference measurement values from calculation expressions and other processing units.

Measurement items	Character string	Description
Judge	JG	Judgment results 0: No judgment (unmeasured) 1: Judgment result OK -1: Judgment result NG -10: Error (image format mismatch) -11: Error (unregistered model) -12: Error (insufficient memory) -20: Error (other errors)

5-4-6 External Reference Tables (Control Flow Normal)

No.	Data name	Data ident	Set/Get	Data range
0	Judge	judge	Get only	0: No judgment (unmeasured), 1: Judgment result OK, -1: Judgment result NG, -10: Error (image format mismatch), -11: Error (unregistered model), -12: Error (insufficient memory), -20: Error (other errors)
5	status	status	Get only	0: Flow is running 1: Flow has stopped
103	Reflect to overall judgement	overallJudge	Set/Get	0: ON, 1: OFF

No.	Data name	Data ident	Set/Get	Data range
120	Timeout	timeout	Set/Get	0: Not used, 1: Used
121	Timeout time[ms]	timeoutTime	Set/Get	0 to 120,000
122	Communication method	comType	Set/Get	0: RS-232C/RS-422 *1 1: Ethernet
123	Unit judgement in timeout	timeoutJudge	Set/Get	0: NG, 1: OK
5,000	Release waiting	releaseWaiting	Set only	1: Release waiting status

*1. RS-422 is unavailable in the FH/FHV series.

5-5 Control Flow PLC Link

This processing item is not available in the FHV series.

This processing item put the measurement flow currently performed into a wait state, and enable a specific communication command from an external device to be performed.

Used in the Following Case

When performing a communication command while processing a measurement flow:

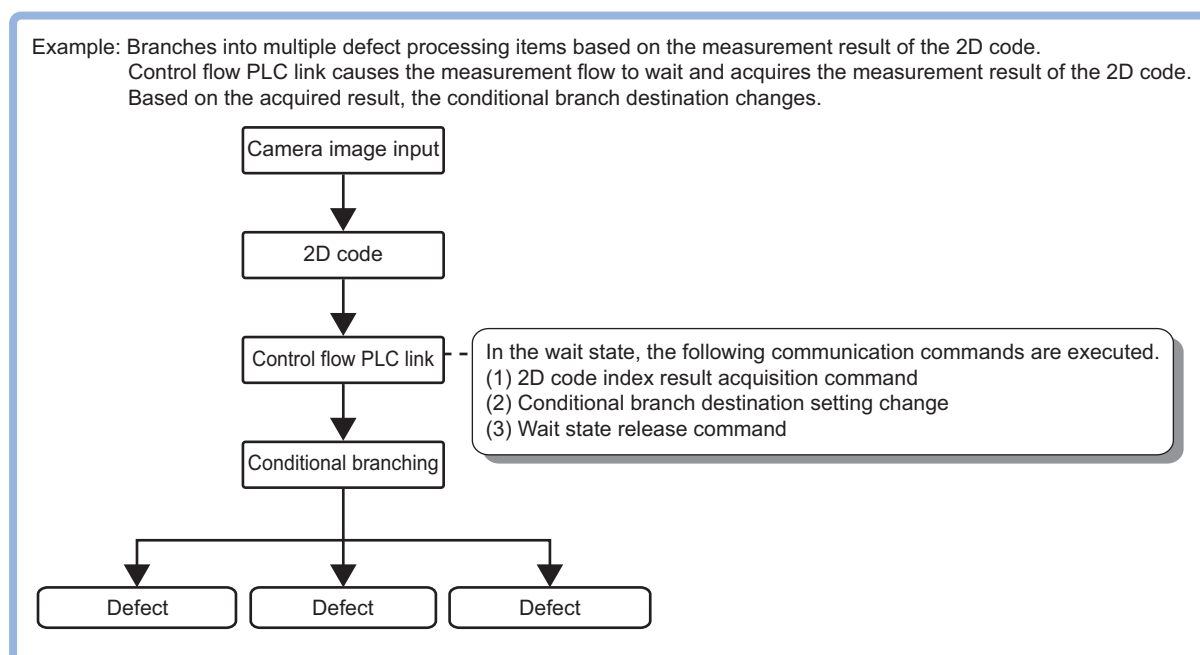

This processing item corresponds to the measurement flow control using the following communication modules.

Parallel	PLC Link	EtherNet/IP	EtherCAT	Non-procedure
-	OK	-	-	-

During the wait state, the communication commands below can be executed. For details about the communication commands, refer to the *Appendixes: Command Control - Command List* in the *Vision System FH/FHV Series User's Manual for Communications Settings (Cat. No. Z342)*.

Command name	Function
Get Unit Data	Gets the parameters and measurement values of processing units.
Set Unit Data	Sets the parameters and measurement values to processing units.
Return to Start of Flow	Branches to the start of the measurement flow (processing unit 0).

To clear the wait state, use the *Set Unit Data* command. By setting 1 to the *Wait state clear command* in the external reference table, the wait state can be cleared. For details, refer to the *5-5-7 External Reference Tables (Control Flow PLC Link)* on page 5-26.

5-5-1 Settings Flow (Control Flow PLC Link)

To set Control Flow PLC Link, follow the steps below.

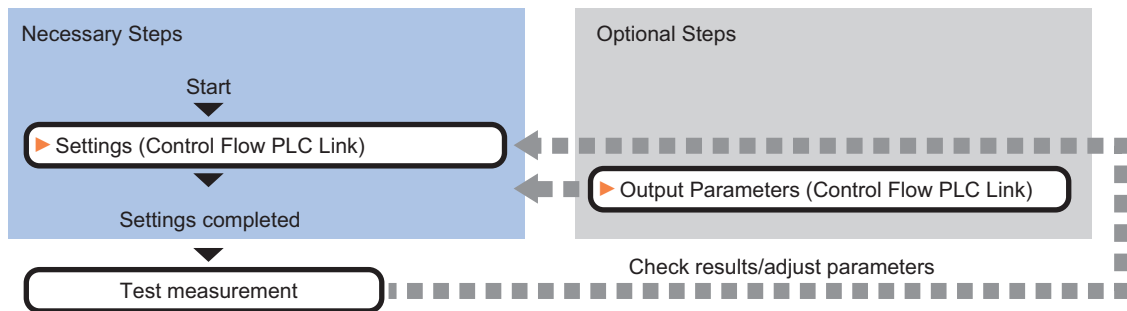

List of Control Flow PLC Link Items

Item	Description
Setting	Sets communication and timeout conditions for controlling the measurement flow.
Output parameter	Sets this to change the output parameters. Set the conditions and parameters to output measurement results to other processing units or external devices as the output parameters.

5-5-2 Settings (Control Flow PLC Link)

Set conditions for communications and timeout to control the measurement flow.

- 1 In the Item Tab area, click **Setting**.

- 2 In the Communication method area, select the item.

Setting item	Setting value [Factory default]	Description
Communication method	<ul style="list-style-type: none"> [RS-232C / RS-422] Ethernet 	Selects the communication method to control the measurement flow from an external device. *1

*1. RS-422 is unavailable in the FH/FHV series.

3 In the Timeout area, set each item.

Setting item	Setting value [Factory default]	Description
Use timeout	<ul style="list-style-type: none"> • [Checked] • Unchecked 	Places a check here when clearing the wait state after a specified time passed. Normally, place a check this to use.
Setting time	0 to 120,000 [5,000]	This is enabled when <i>Use timeout</i> is checked. Specifies the time in ms until the wait state set by this processing unit is cleared. When the timeout is used, the wait state is cleared after the time set in the <i>Setting time</i> passed from the start of measurement processing of this processing unit. The measurement flow resumes after the wait state was cleared.
Unit judgment in timeout	<ul style="list-style-type: none"> • [NG] • OK 	This is enabled when <i>Use timeout</i> is checked. Selects whether to set OK or NG as the judgment result of this processing unit when this processing unit was timed out in the measurement processing after the "Setting time" elapsed.



Precautions for Correct Use

Normally, the *Use timeout* should be checked. If it were unchecked, the wait state can be cleared only by transmitting the *Wait state clear command* from an external device.

5-5-3 Output Parameters (Control Flow PLC Link)

Set this item to change the output parameters.

As the output parameters, set the conditions and parameters to output measurement results to other processing units and external devices. Normally, the factory default values can be used.

1 In the Item Tab area, click **Output parameter**.

2 Select the item.

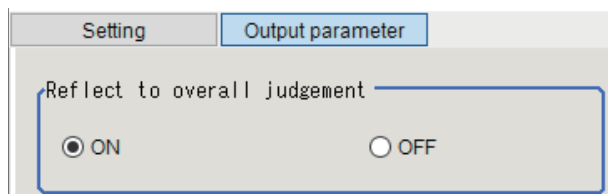

Setting item	Setting value [Factory default]	Description
Reflect to overall judgment	<ul style="list-style-type: none"> • [ON] • OFF 	Enables choosing whether or not the judgement results of this processing unit is reflected in the scene overall judgment.

5-5-4 Key Points for Test Measurement and Adjustment (Control Flow PLC Link)

The following content is displayed in the *Detail result* area as text.

Displayed item	Description
Judge	Judgment results 0: No judgment (unmeasured) 1: Judgment result OK -1: Judgment result NG -10: Error (image format mismatch) -11: Error (unregistered model) -12: Error (insufficient memory) -20: Error (other errors)

The image specified in the Sub-image number in the image display setting is displayed in the *Image Display* area.

Sub-image number	Description of image to be displayed
0	Measurement image

5-5-5 Measurement Results for Which Output Is Possible (Control Flow PLC Link)

The following values can be output using processing items related to result output. It is also possible to reference measurement values from calculation expressions and other processing units.

Measurement items	Character string	Description
Judge	JG	Judgment results 0: No judgment (unmeasured) 1: Judgment result OK -1: Judgment result NG -10: Error (image format mismatch) -11: Error (unregistered model) -12: Error (insufficient memory) -20: Error (other errors)

5-5-6 Timing Chart (Control Flow PLC Link)

To perform a command during the measurement flow by using the **Control Flow PLC Link** processing item, control the Sensor Controller paying attention to each signal timing from external devices. Refer to the timing chart below.

Ex.:

Perform the measurement command with PLC Link, and then perform the *Set Unit Data* command with the *Control Flow PLC Link* processing during measurement.

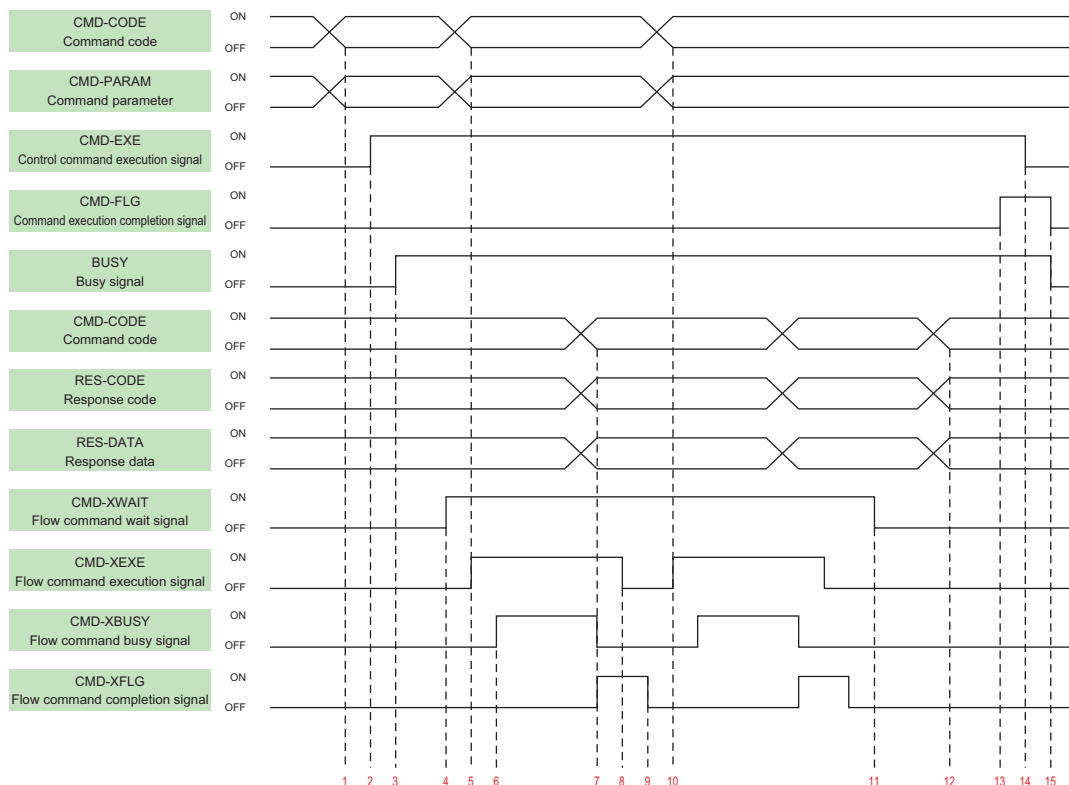

1. Set the command code and command parameters to be executed by the user (PLC). (In the above example, this is the measurement command.)
2. The user (PLC) turns ON the control command execution signal (EXE signal).
3. The sensor controller turns ON the processing busy signal (BUSY signal)
4. When the processing unit is executed inside the measurement flow, the Sensor Controller turns ON the measuring command standby signal (XWAIT signal).
5. The user (PLC) sets the command code to be executed during measurement and the command parameters, during measurement, and turns ON the measuring command execution signal (XEXE signal). (In the above example, this is the Set Unit Data command.)
6. The sensor controller turns ON the measuring command executing signal (XBUSY signal).
7. After setting the command code executed during measurement, the response code, and response data, the sensor controller turns ON the flow command completion signal (XFLG signal), and turns OFF the measuring command executing signal (XBUSY signal).
8. The user (PLC) turns OFF the flow command execution signal (XEXE signal). If the signal does not turn OFF within the set timeout time, the control flow advances directly to step 14.
9. The sensor controller turns OFF the measuring command completion signal (XFLG signal).
10. The user (PLC) sets the command code to be executed during measurement and the command parameters, during measurement, and turns ON the measuring command execution signal (XEXE signal). (In the above example, this is clearing of the wait state by the processing unit data setting command.) After this, steps 6 through 9 are performed.
11. When the processing unit finishes measurement processing, the sensor controller turns OFF the measuring command standby signal (XWAIT signal).
12. The sensor controller sets the executed command code, response code, and response data.
13. The sensor controller turns ON the command completion signal (FLG signal).

14. The user (PLC) turns OFF the command execution signal (EXE signal).
15. The sensor controller turns OFF the command completion signal (FLG signal), and turns OFF the processing busy signal (BUSY signal).

5-5-7 External Reference Tables (Control Flow PLC Link)

No.	Data name	Data ident	Set/Get	Data range
0	Judge	judge	Get only	0: No judgment (unmeasured), 1: Judgment result OK, -1: Judgment result NG, -10: Error (image format mismatch), -11: Error (unregistered model), -12: Error (insufficient memory), -20: Error (other errors)
5	status	status	Get only	0: Flow is running 1: Flow has stopped
103	Reflect to overall judgement	overallJudge	Set/Get	0: ON, 1: OFF
120	Timeout	timeout	Set/Get	0: Not used, 1: Used
121	Timeout time[ms]	timeoutTime	Set/Get	0 to 120,000
122	Communication method	comType	Set/Get	0: RS-232C/RS-422 *1 1: Ethernet
123	Unit judgement in timeout	timeoutJudge	Set/Get	0: NG, 1: OK
5,000	Release waiting	releaseWaiting	Set only	1: Release waiting status

*1. RS-422 is unavailable in the FH/FHV series.

5-6 Control Flow Parallel

This processing item is not available in the FHV series.

This processing item put the measurement flow currently performed into a wait state, and enable a specific communication command from an external device to be performed.

Used in the Following Case

When performing a communication command while processing a measurement flow:

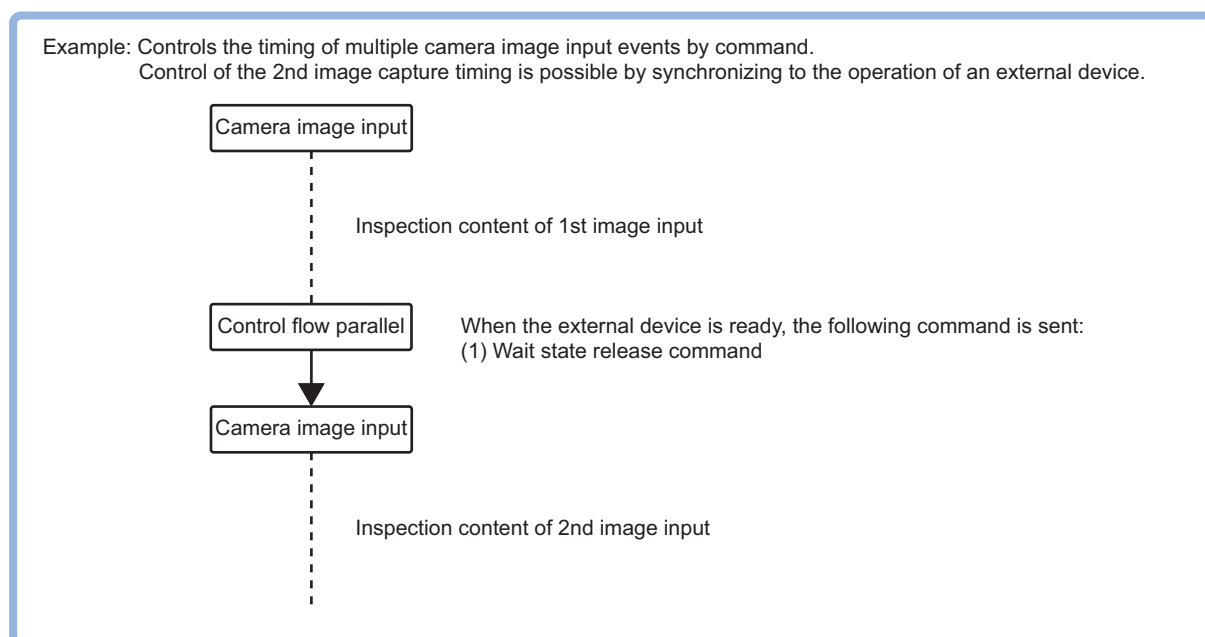

This processing item corresponds to the measurement flow control using the following communication modules.

Parallel	PLC Link	EtherNet/IP	EtherCAT	Non-procedure
OK	-	-	-	-

Put the measurement flow into a wait state, and enable a specific command to be performed. There two ways to clear the wait state; using a command, or setting timeout.

During the wait state, the communication commands below can be executed.

Item	Description	Input Format (DI7 to DI0)			Input Ex. (DI7 to DI0)
		Execution (DI7)	Command (DI6, DI5)	Command Data (DI4 to DI0)	
Wait state release	Clears the wait state for processing items for control flow parallel.	1	10	10	11001111

5-6-1 Settings Flow (Control Flow Parallel)

To set Control Flow Parallel, follow the steps below.

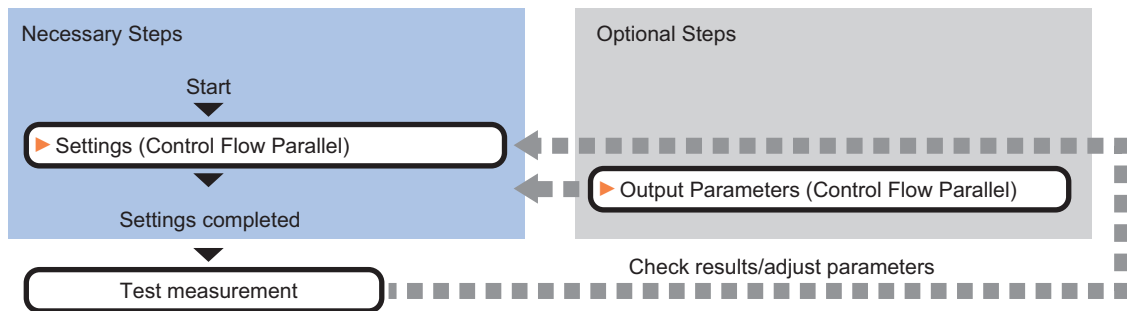

List of Control Flow Parallel Items

Item	Description
Setting	Sets communication and timeout conditions for controlling the measurement flow.
Output parameter	<p>Sets this to change the output parameters.</p> <p>Set the conditions and parameters to output measurement results to other processing units or external devices as the output parameters.</p>

5-6-2 Settings (Control Flow Parallel)

Set conditions for communications and timeout to control the measurement flow.

- 1 In the Item Tab area, click **Setting**.

- 2 In the *Timeout* area, set each item.

Setting item	Setting value [Factory default]	Description
Use timeout	<ul style="list-style-type: none"> [Checked] Unchecked 	Places a check here when clearing the wait state after a specified time passed. Normally, place a check this to use.
Setting time	0 to 120,000 [5,000]	This is enabled when <i>Use timeout</i> is checked. Specifies the time in ms until the wait state set by this processing unit is cleared. When the timeout is used, the wait state is cleared after the time set in the <i>Setting time</i> passed from the start of measurement processing of this processing unit. The measurement flow resumes after the wait state was cleared.
Unit judgment in timeout	<ul style="list-style-type: none"> [NG] OK 	This is enabled when <i>Use timeout</i> is checked. Selects whether to set OK or NG as the judgment result of this processing unit when this processing unit was timed out in the measurement processing after the "Setting time" elapsed.



Precautions for Correct Use

Normally, the *Use timeout* should be checked. If it were unchecked, the wait state can be cleared only by transmitting the *Wait state clear command* from an external device.

- 3** In the *DO signal setting* area, set each item.

Setting item	Setting value [Factory default]	Description
Wait signal	<ul style="list-style-type: none"> [Checked] Unchecked 	Places a check here when using the DO signal as a Flow Command Wait signal. Normally, place a check this to use.
Signal No.	DO0 to DO15 [DO0]	Sets the signal used as a WAIT signal. The signal set here can be used as a Flow Command Wait signal.
FLG signal	<ul style="list-style-type: none"> [Checked] Unchecked 	Places a check here when using the DO signal as a Flow Command Completion signal. Normally, place a check this to use.
Signal No.	DO0 to DO15 [DO1]	Sets the signal used as the FLG signal. This signal set here can be used as a Flow Command Completion signal.



Additional Information

If the same signal number is assigned for the WAIT signal and the FLG signal, an error message, *Same Signals are Assigned*, will be displayed. Assign different signal number for each signal.

5-6-3 Output Parameters (Control Flow Parallel)

Set this item to change the output parameters.

As the output parameters, set the conditions and parameters to output measurement results to other processing units and external devices. Normally, the factory default values can be used.

1 In the Item Tab area, click **Output parameter**.

2 Select the item.

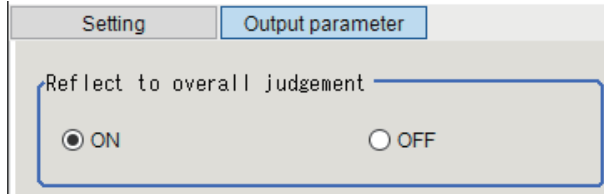

Setting item	Setting value [Factory default]	Description
Reflect to overall judgement	<ul style="list-style-type: none"> • [ON] • OFF 	Enables choosing whether or not the judgement results of this processing unit is reflected in the scene overall judgement.

5-6-4 Key Points for Test Measurement and Adjustment (Control Flow Parallel)

The following content is displayed in the *Detail result* area as text.

Displayed item	Description
Judge	Judgment results 0: No judgment (unmeasured) 1: Judgment result OK -1: Judgment result NG -10: Error (image format mismatch) -11: Error (unregistered model) -12: Error (insufficient memory) -20: Error (other errors)

The image specified in the Sub-image number in the image display setting is displayed in the *Image Display* area.

Sub-image number	Description of image to be displayed
0	Measurement image

5-6-5 Measurement Results for Which Output Is Possible (Control Flow Parallel)

The following values can be output using processing items related to result output. It is also possible to reference measurement values from calculation expressions and other processing units.

Measurement items	Character string	Description
Judge	JG	Judgment results 0: No judgment (unmeasured) 1: Judgment result OK -1: Judgment result NG -10: Error (image format mismatch) -11: Error (unregistered model) -12: Error (insufficient memory) -20: Error (other errors)

5-6-6 External Reference Tables (Control Flow Parallel)

No.	Data name	Data ident	Set/Get	Data range
0	Judge	judge	Get only	0: No judgment (unmeasured), 1: Judgment result OK, -1: Judgment result NG, -10: Error (image format mismatch), -11: Error (unregistered model), -12: Error (insufficient memory), -20: Error (other errors)
5	status	status	Get only	0: Flow is running 1: Flow has stopped
103	Reflect to overall judgement	overallJudge	Set/Get	0: ON, 1: OFF
120	Timeout	timeout	Set/Get	0: Not used, 1: Used
121	Timeout time[ms]	timeoutTime	Set/Get	0 to 120,000
122	WAIT signal	readyOutput	Set/Get	0: Not used, 1: Used
123	WAIT signal No.	readyOutputNo	Set/Get	0 to 15: DO0 to DO15
124	FLG signal	flgOutput	Set/Get	0: Not used, 1: Used
125	FLG signal No.	flgOutputNo	Set/Get	0 to 15: DO0 to DO15
126	Unit judgement in timeout	timeoutJudge	Set/Get	0: NG, 1: OK
5,000	Release waiting	releaseWaiting	Set only	1: Release waiting status

5-7 Control Flow Fieldbus

This processing item is not available in the FHV series.

This processing item put the measurement flow currently performed into a wait state, and enable a specific communication command from an external device to be performed.

Used in the Following Case

When performing a communication command while processing a measurement flow:

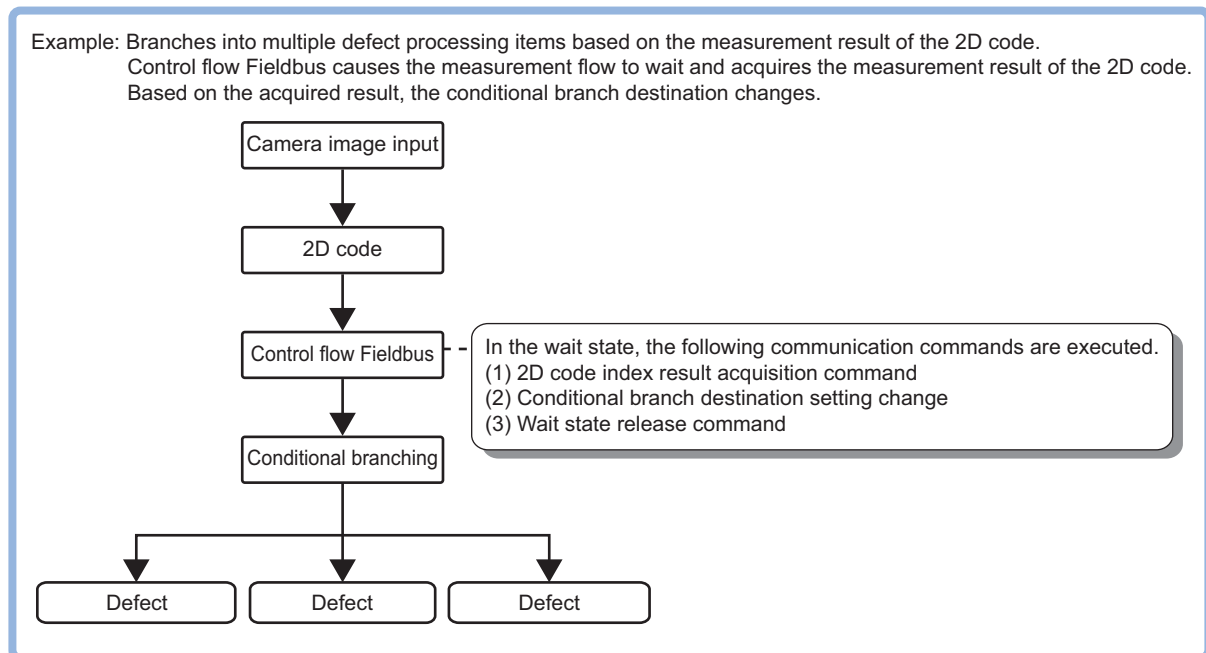

This processing item corresponds to the measurement flow control using the following communication modules.

Parallel	PLC Link	EtherNet/IP	EtherCAT	Non-procedure
-	-	OK	OK	-

During the wait state, the communication commands below can be executed. For details about the communication commands, refer to the *Appendixes: Command Control - Command List* in the *Vision System FH/FHV Series User's Manual for Communications Settings (Cat. No. Z342)*.

Command name	Function
Get Unit Data	Gets the parameters and measurement values of processing units.
Set Unit Data	Sets the parameters and measurement values to processing units.
Return to Start of Flow	Branches to the start of the measurement flow (processing unit 0).

To clear the wait state, use the *Set Unit Data* command. By setting *1* to the *Wait state clear command* in the external reference table, the wait state can be cleared. For details, refer to the *5-7-7 External Reference Tables (Control Flow Fieldbus)* on page 5-38.

5-7-1 Settings Flow (Control Flow Fieldbus)

To set Control Flow Fieldbus, follow the steps below.

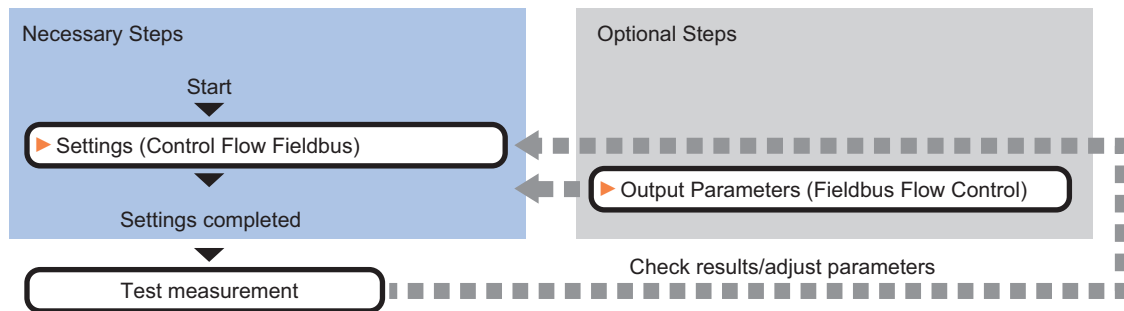

List of Control Flow Fieldbus Items

Item	Description
Setting	Sets communication and timeout conditions for controlling the measurement flow.
Output parameter	Sets this to change the output parameters. Set the conditions and parameters to output measurement results to other processing units or external devices as the output parameters.

5-7-2 Settings (Control Flow Fieldbus)

Set conditions for communications and timeout to control the measurement flow.

- 1 In the Item Tab area, click **Setting**.

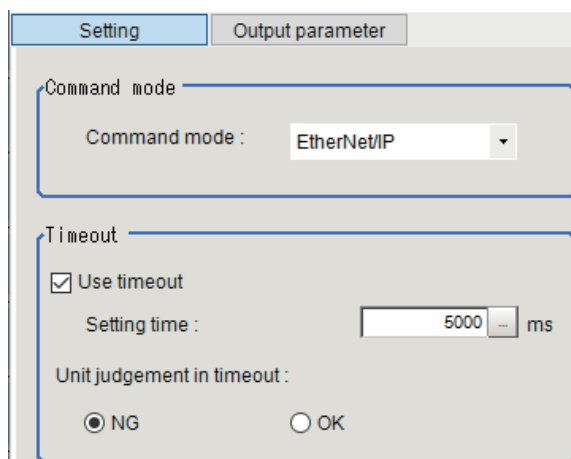

- 2 In the *Communication method* area, select the item.

Setting item	Setting value [Factory default]	Description
Communication method	<ul style="list-style-type: none"> • [EtherNet/IP] • EtherCAT • PROFINET 	Selects the communication method to control the measurement flow from an external device.

3 In the *Timeout* area, set each item.

Setting item	Setting value [Factory default]	Description
Use timeout	<ul style="list-style-type: none"> • [Checked] • Unchecked 	Places a check here when clearing the wait state after a specified time passed. Normally, place a check this to use.
Setting time	0 to 120,000 [5,000]	This is enabled when <i>Use timeout</i> is checked. Specifies the time in ms until the wait state set by this processing unit is cleared. When the timeout is used, the wait state is cleared after the time set in the <i>Setting time</i> passed from the start of measurement processing of this processing unit. The measurement flow resumes after the wait state was cleared.
Unit judgment in timeout	<ul style="list-style-type: none"> • [NG] • OK 	This is enabled when <i>Use timeout</i> is checked. Selects whether to set OK or NG as the judgment result of this processing unit when this processing unit was timed out in the measurement processing after the "Setting time" elapsed.



Precautions for Correct Use

Normally, the *Use timeout* should be checked. If it were unchecked, the wait state can be cleared only by transmitting the *Wait state clear command* from an external device.

5-7-3 Output Parameters (Control Flow Fieldbus)

Set this item to change the output parameters.

As the output parameters, set the conditions and parameters to output measurement results to other processing units and external devices. Normally, the factory default values can be used.

1 In the Item Tab area, click **Output parameter**.

2 Select the item.

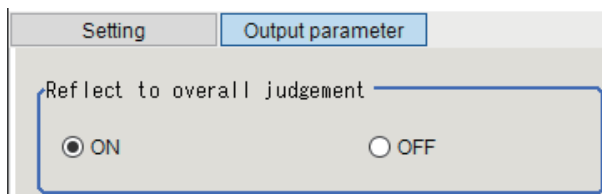

Setting item	Setting value [Factory default]	Description
Reflect to overall judgment	<ul style="list-style-type: none"> • [ON] • OFF 	Enables choosing whether or not the judgment results of this processing unit is reflected in the scene overall judgment.

5-7-4 Key Points for Test Measurement and Adjustment (Control Flow Fieldbus)

The following content is displayed in the *Detail result* area as text.

Displayed item	Description
Judge	Judgment results 0: No judgment (unmeasured) 1: Judgment result OK -1: Judgment result NG -10: Error (image format mismatch) -11: Error (unregistered model) -12: Error (insufficient memory) -20: Error (other errors)

The image specified in the Sub-image number in the image display setting is displayed in the *Image Display* area.

Sub-image number	Description of image to be displayed
0	Measurement image

5-7-5 Measurement Results for Which Output Is Possible (Control Flow Fieldbus)

The following values can be output using processing items related to result output. It is also possible to reference measurement values from calculation expressions and other processing units.

Measurement items	Character string	Description
Judge	JG	Judgment results 0: No judgment (unmeasured) 1: Judgment result OK -1: Judgment result NG -10: Error (image format mismatch) -11: Error (unregistered model) -12: Error (insufficient memory) -20: Error (other errors)

5-7-6 Timing Chart (Control Flow Fieldbus)

To perform a command during the measurement flow by using the **Control Flow Fieldbus** processing item, control the Sensor Controller paying attention to each signal timing from external devices. Refer to the timing chart below.

Flow Control in EtherCAT Communication

The following shows the basic timing chart when the *Control Flow Fieldbus* is used in EtherCAT communication.

Ex. :

A measurement trigger is input via EtherCAT, and perform the *Set Unit Data* command with *Control Flow Fieldbus* processing during measurement.

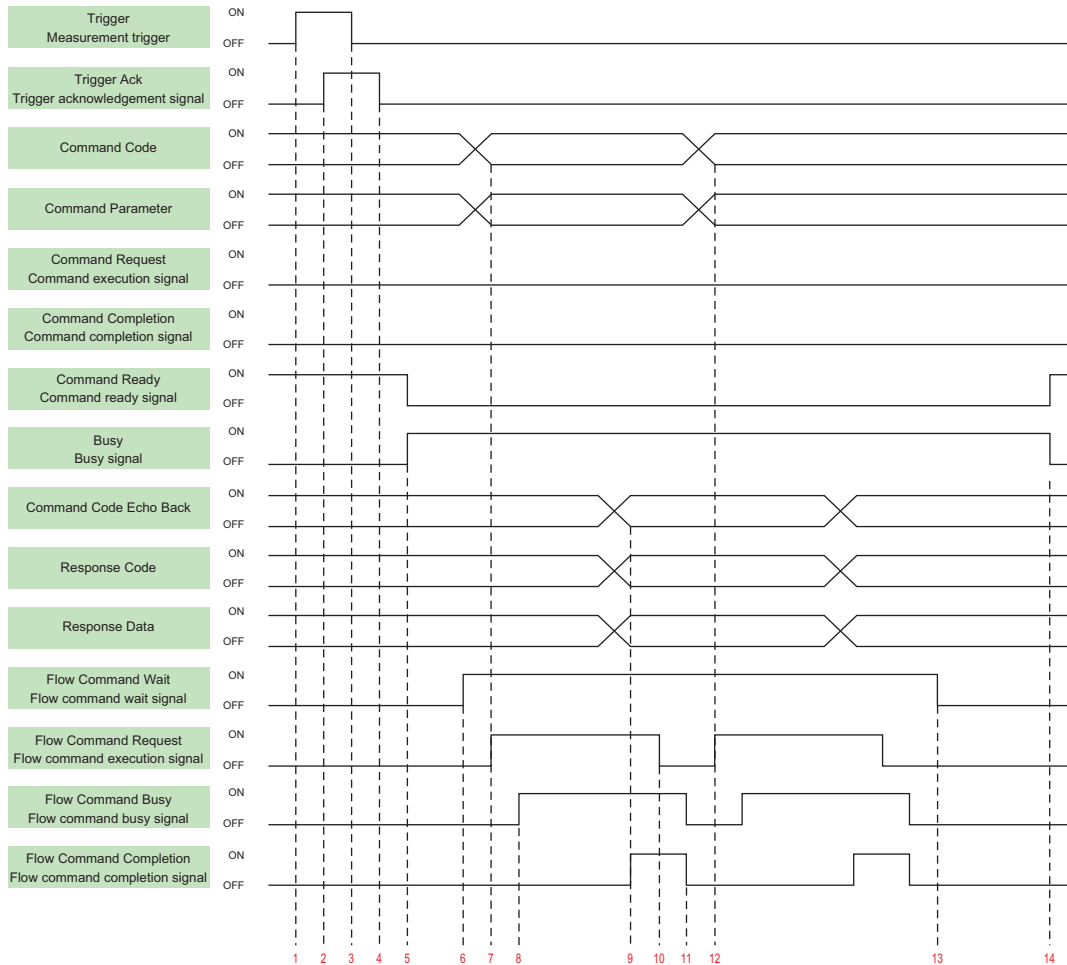

1. The controller (master) turns ON the measurement trigger signal (Trigger signal).
2. The Sensor Controller (slave) turns ON the trigger acknowledge signal (Trigger Ack signal).
3. The controller (slave) turns OFF the measurement trigger signal (Trigger signal).
4. The Sensor Controller (slave) turns OFF the trigger acknowledge signal (Trigger Ack signal).
5. The Sensor Controller (slave) turns ON the processing signal (Busy signal).
6. When the processing unit is executed inside the measurement flow, the Sensor Controller (slave) turns ON the flow command wait signal (Flow Command Wait signal).
7. The controller (master) sets the command code and command parameters to be executed during measurement, and turns ON the measuring command execution signal (Flow Command Request signal). (In the above example, this is the Set Unit Data command.)
8. The Sensor Controller (slave) turns ON the measuring command executing signal (Flow Command Busy signal).
9. After setting the echo back of the command code executed during measurement, the response code, and response data, the Sensor Controller turns ON the flow command completion signal (Flow Command Completion signal), and turns OFF the flow command busy signal (Flow Command Busy signal).
10. The controller (master) turns OFF the flow command execution signal (Flow Command Request signal). If the signal does not turn OFF within the set timeout time, the control flow advances directly to step 13.

11. The sensor Controller (slave) turns OFF the measuring command completion signal (Flow completion Busy signal).
12. The controller (master) sets the command code and command parameters to be executed during measurement, and turns ON the measuring command execution signal (Flow Command Request signal). (In the above example, the wait state is cleared by Set Unit Data command.) After this, steps 8 through 11 are performed.
13. When the processing unit finishes measurement processing, the Sensor Controller (slave) turns OFF the measuring command standby signal (Flow Command Wait signal).
14. When execution of the measurement flow ends, the Sensor Controller (slave) turns OFF the Command executing signal (Busy signal).

Flow control in EtherNet/IP Communication

The following is the basic timing chart when Control Flow Fieldbus is used in EtherNet/IP communication.

Ex. :

A measurement trigger is input via EtherNet/IP, and perform the *Set Unit Data* command with *Control Flow Fieldbus* processing during measurement.

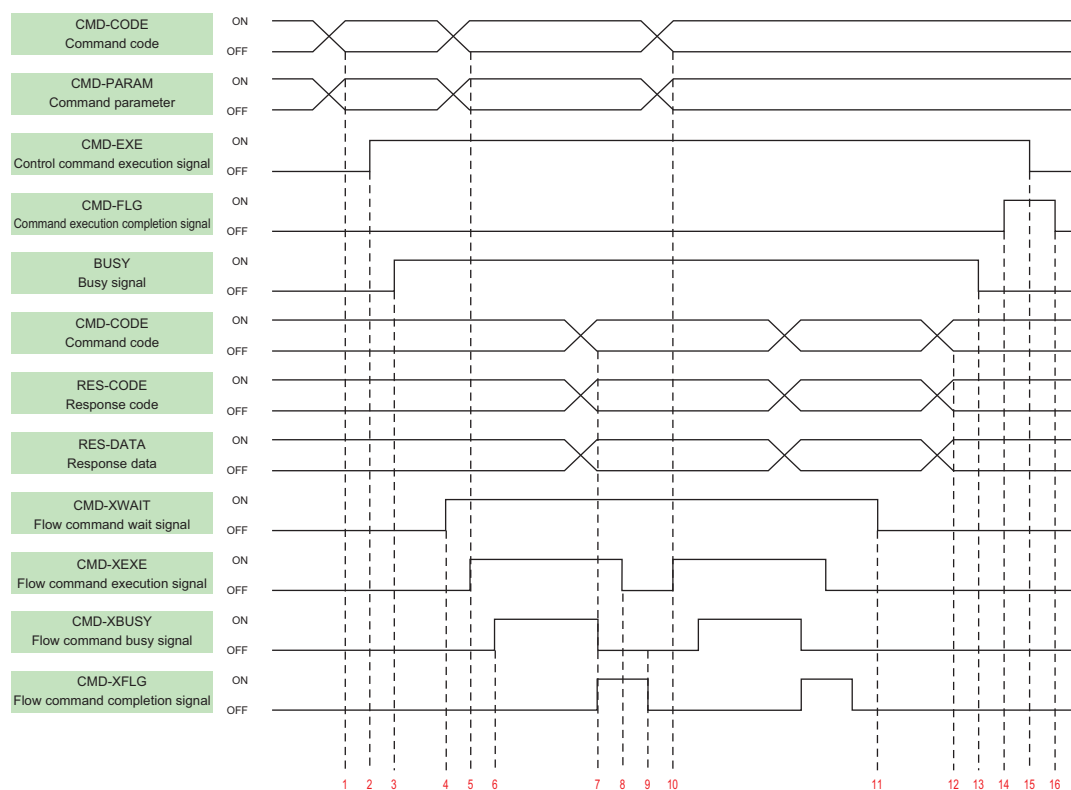

1. Set the command code and command parameters to be executed by the user (PLC). (In the above example, this is the measurement command.)
2. The user (PLC) turns ON the control command execution signal (EXE signal).
3. The user (PLC) turns ON the control command execution signal (EXE signal).
4. When the processing unit is executed inside the measurement flow, the sensor controller turns ON the measuring command standby signal (XWAIT signal).

5. The user (PLC) sets the command code to be executed during measurement and the command parameters, during measurement, and turns ON the measuring command execution signal (XEXE signal). (In the above example, this is the Set Unit Data command.)
6. The Sensor Controller turns ON the measuring command executing signal (XBUSY signal).
7. After setting the command code executed during measurement, the response code, and response data, the Sensor Controller turns ON the flow command completion signal (XFLG signal), and turns OFF the measuring command executing signal (XBUSY signal).
8. The user (PLC) turns OFF the flow command execution signal (XEXE signal). If the signal does not turn OFF within the set timeout time, the control flow advances directly to step 14.
9. The Sensor Controller turns OFF the measuring command execution signal (XEXE signal) and the measuring command completion signal (XFLG signal).
10. The user (PLC) sets the command code to be executed during measurement and the command parameters, during measurement, and turns ON the measuring command execution signal (XEXE signal). (In the above example, this is clearing of the wait state by the Set Unit Data command.) After this, steps 6 through 9 are performed.
11. When the processing unit finishes measurement processing, the Sensor Controller turns OFF the measuring command standby signal (XWAIT signal).
12. The Sensor Controller sets the executed command code, response code, and response data. The Sensor Controller turns OFF the command executing signal (BUSY signal).
13. The Sensor Controller turns ON the command completion signal (FLG signal).
14. The user (PLC) turns OFF the control command execution signal (EXE signal).
15. The Sensor Controller turns OFF the command completion signal (FLG signal).

5-7-7 External Reference Tables (Control Flow Fieldbus)

No.	Data name	Data ident	Set/Get	Data range
0	Judge	judge	Get only	0: No judgment (unmeasured), 1: Judgment result OK, -1: Judgment result NG, -10: Error (image format mismatch), -11: Error (unregistered model), -12: Error (insufficient memory), -20: Error (other errors)
5	status	status	Get only	0: Flow is running 1: Flow has stopped
103	Reflect to overall judgement	overallJudge	Set/Get	0: ON, 1: OFF
120	Timeout	timeout	Set/Get	0: Not, used 1: Used
121	Timeout time[ms]	timeoutTime	Set/Get	0 to 120,000
122	Communication method	comType	Set/Get	0: EtherNet/IP, 1: EtherCAT, 2: PROFINET
123	Unit judgement in timeout	timeoutJudge	Set/Get	0: NG, 1: OK
5,000	Release waiting	releaseWaiting	Set only	1: Release waiting status

5-8 Selective Branch

This processing item is not available in the FHV series.

Setting calculation expressions and selected values branches the processing of the subsequent items from here by the conformance result of the calculation results and selected values.

Up to 32 branch destinations can be set.

Used in the Following Case

When applying different inspections to products on one production line according to a time band:

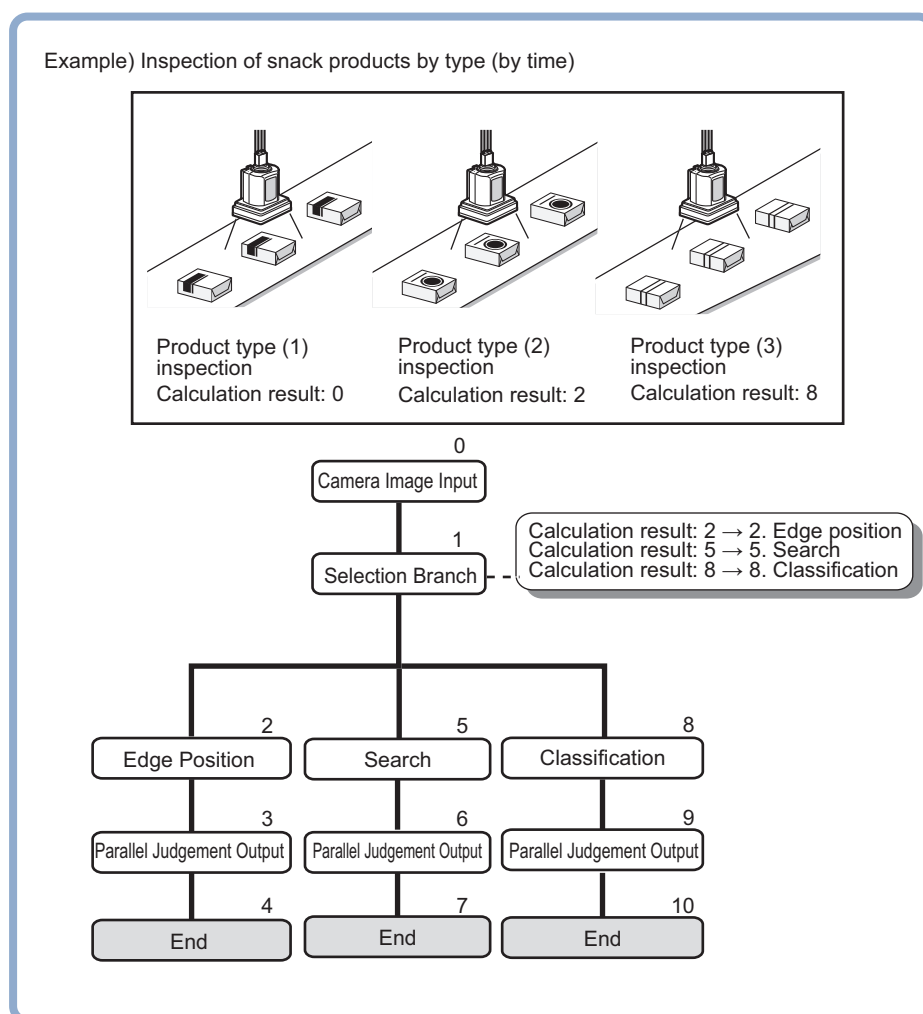

List of Selective Branch Items

Item	Description
Selective Branch	This item sets the branch conditions 5-8-1 Selective Branch (Selective Branch) on page 5-40
Output parameter	This item can be changed as necessary. Normally, the factory default value will be used. 5-8-2 Output Parameters (Selective Branch) on page 5-41
Timeout	This item sets the conditions that the branch processing times out. 5-8-3 Timeout (Selective Branch) on page 5-41

5-8-1 Selective Branch (Selective Branch)

Set the branch conditions. Up to 32 branch destinations can be set. As the branch destinations can be easily enabled or disabled using checkboxes, set them as necessary.

- 1 In the Item Tab area, click **Selective branch**.
- 2 In the *Condition setting* area, set the expression for the branch conditions.

- 3 In the *Branch place setting* area, click the number of the branch destination to set the branch conditions.
Clicking **Enable all** will enable all branch destinations.
Clicking **Disable all** will disable all branch destinations.

No.	Condition value	Destination unit	Comment
<input checked="" type="checkbox"/>	0	(End processing)	
<input type="checkbox"/>	1	(End processing)	
<input type="checkbox"/>	2	(End processing)	
<input type="checkbox"/>	3	(End processing)	
<input type="checkbox"/>	4	(End processing)	
<input type="checkbox"/>	5	(End processing)	
<input type="checkbox"/>	6	(End processing)	
<input type="checkbox"/>	7	(End processing)	
<input type="checkbox"/>	8	(End processing)	
<input type="checkbox"/>	9	(End processing)	
<input type="checkbox"/>	10	(End processing)	

- 4 Click , <, or > at the *Condition value* to set the selection value.

- 5 Click at the **Destination unit** to select the branch destination unit.
When *Display only folder* is checked, only the first unit in the folder will be the setting target.

- 6 Click at the *Comment* to input comments.
Multilingual is also supported.

For details, refer to *Inputting Text* in the *Vision System FH/FHV Series User's Manual (Cat. No. Z365)*.

- 7** Click at the **Destination unit** in the *Miscompare setting* area to set the branch destination unit.

When *Display only folder* is checked, only the first unit in the folder will be the setting target.

- 8** Select **Judgement**.

- 9** Click **OK**.

5-8-2 Output Parameters (Selective Branch)

Specify whether or not the judgement results of this processing unit is reflected in the scene overall judgement.

- 1** In the Item Tab area, click **Output parameter**.
- 2** Select the *Reflect to overall judgement*.

Setting item	Setting value [Factory default]	Description
Reflect to overall judgement	<ul style="list-style-type: none"> • [ON] • OFF 	Enables choosing whether or not the judgement results of this processing unit is reflected in the scene overall judgement.

5-8-3 Timeout (Selective Branch)

Set the conditions for the timeout of branch processing.

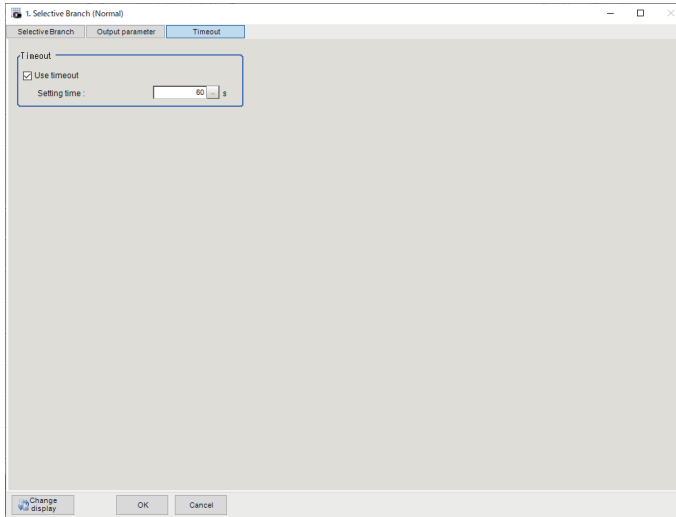

- 1 In the Item Tab area, click **Timeout**.
- 2 In the *Timeout* area, set each item.

Setting item	Setting value [Factory default]	Description
Use timeout	<ul style="list-style-type: none"> • [Checked] • Unchecked 	Places a check here to time out the Selective branch processing after passing the specified time.
Setting time	1 to 3,600 [60]	<p>This is enabled when the <i>Use timeout</i> is checked.</p> <p>Sets the time in seconds until the measurement processing is timed out on this processing unit.</p> <p>When the measurement processing for this unit was performed, it will be timed out when the time from the measurement start exceeded the <i>Setting time</i>. When the measurement processing was timed out, the judgment result becomes NG.</p>



Precautions for Correct Use

- Normally, the *Use timeout* should be checked. If it were unchecked, a measurement flow can fall into infinite loop depending on the settings for the *Selective Branch*.
- When using the *Selective Branch* in a block of the parallelization task in the measurement flow, set it that branches occur only within the block. If the branches occurred across the blocks of the parallelization task, the timeout may not function properly even if the *Use timeout* were checked.

5-8-4 Key Points for Test Measurement and Adjustment (Selective Branch)

Select the adjustment method referring to the following points.

Key Points for Adjustment (Selective Branch)

Adjust the setting parameters referring to the following points.

- **When the system freezes after executing the measurement**

Parameter to be adjusted	Remedy
Selection branch	An infinite loop occurs when the branch destination unit is incorrect. In order to avoid a measurement processing looping, for the branch destination, set a processing unit number that is after the Selection branch .

- **When measurement processing of an unintended unit is executed**

Parameter to be adjusted	Remedy
Measurement flow	If the End is not registered at the end of a branch, the processing in the scene will continue to move to the next unit No. even if the branch has been completed. Make sure to set the End at the last branch destination.

- **When the judgement results (JG) of the unit within the flow is updated or not updated**

Parameter to be adjusted	Remedy
Measurement flow	The system is designed this way. For results other than the unit's judgement results (JG), the measurement result during the previous pas ed. The JG for units that do not pass through the condition branch becomes unmeasured (0). Note, however, that the unit JG becomes unmeasured at the point in time when all the measurement processing ends. During flow processing, the previous time judgement (JG) is retained.

5-8-5 Measurement Results for Which Output Is Possible (Selective Branch)

The following values can be output using processing items related to result output. It is also possible to reference measurement values from calculation expressions and other processing units.

Measurement items	Character string	Description
Judge	JG	Judgment results 0: No judgment (unmeasured) 1: Judgment result OK -1: Judgment result NG -10: Error (image format mismatch) -11: Error (unregistered model) -12: Error (insufficient memory) -20: Error (other errors)
Condition No.	JN	Condition number that matches the selection condition expression result
Destination unit No.	BU	Branch destination unit number of the condition that matches the selection condition expression result
Conditional expression	DJ	Expression result of the selection conditional expression

5-8-6 External Reference Tables (Selective Branch)

No.	Data name	Data ident	Set/Get	Data range
0	Judge	judge	Get only	0: No judgment (unmeasured), 1: Judgment result OK, -1: Judgment result NG, -10: Error (image format mismatch), -11: Error (unregistered model), -12: Error (insufficient memory), -20: Error (other errors)
5	Condition No.	jumpUnitNo	Get only	-1 to 31
6	Branch place	resultNoJudge	Get only	-1 to 9,999
7	Conditional expression	resultExpJudge	Get only	-
103	Reflect to overall judgement	overallJudge	Set/Get	0 :ON, 1:OFF
120	Miscompare branch place	jumpUnitNoDefault	Set/Get	-1 to 9,999
121	Miscompare judgement	unitJudgeDefault	Set/Get	0: NG, 1: OK
122	Conditional expression	expressionJudge	Set/Get	Exp. character string
123	Timeout	timeout	Set/Get	0: Not used, 1: Used
124	Timeout time[s]	timeoutTime	Set/Get	1 to 3,600
130+N×10 (N=0 to 31)	Destination unit No.	unitBranchOK00 to unitBranchOK31	Set/Get	-1 to 9,999
131+N×10 (N=0 to 31)	Condition value	expression00 to ex- pression31	Set/Get	-9,999 to 9,999
132+N×10 (N=0 to 31)	Comment	comment00 to com- ment31	Set/Get	Character string
133+N×10 (N=0 to 31)	Validation Flag	checkFlag00 to checkFlag31	Set/Get	0: No validation 1: Validation

5-9 Conditional Execution (If)

Setting calculation expressions and conditions branches the measurement flow according to the comparison result.

Used in the Following Case

When branching the processing according to the intermediate results of the measurement flow:

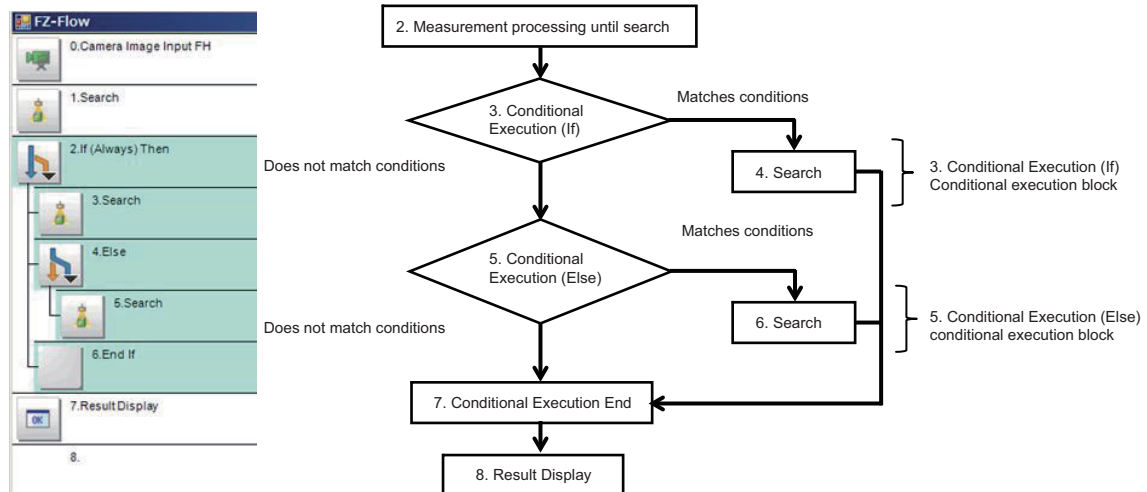

Precautions for Correct Use

- Be sure to pair *Conditional Execution (If)* and *Conditional Execution End* processing items.
- Be sure to insert *Conditional Execution (Else)* processing item between *Conditional Execution (If)* and *Conditional Execution End* processing items.
- When using a *Conditional Branch* processing item within a Conditional Execution block, be sure to locate the branch destination unit within the same Conditional Execution block.
- When using a *Conditional Branch* processing item outside a Conditional Execution block, be sure to avoid locating the branch destination unit within the Conditional Execution block

5-9-1 Conditional Execution Settings (Conditional Execution (If))

Set the following two settings.

- Flow settings to perform *Conditional Execution (If)* processing item (Conditional Execution block settings).
- Conditions settings to be performed in *Conditional Execution (If)* .

Setting the Flow to Perform (Conditional Execution Block Settings)

Set the flow to perform when conditions are met between the *Conditional Execution (If)* and *Conditional Execution End* processing items.

- 1 In the Edit Flow window, add the *Conditional Execution (If)* processing item to the flow. The *Conditional Execution (If)* and *Conditional Execution End* processing items are added to the flow as a pair.

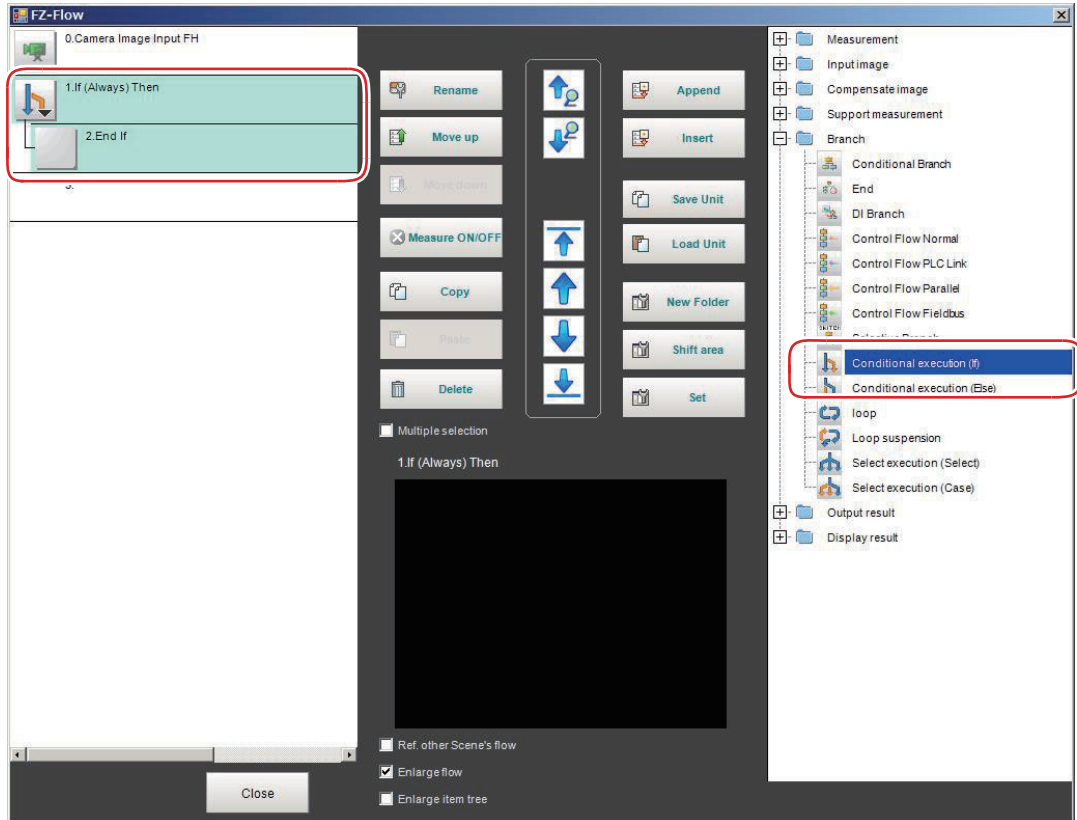

- 2 Set the Conditional Execution block between the *Conditional Execution (If)* and *Conditional Execution End* processing items.

Setting Conditions

Set the condition details and comparison conditions.

- 1 In the Edit Flow window, select the *Conditional Execution (If)* processing item to set conditions. From the selected *Conditional Execution (If)* processing item to the *Conditional Execution End* processing item are selected.

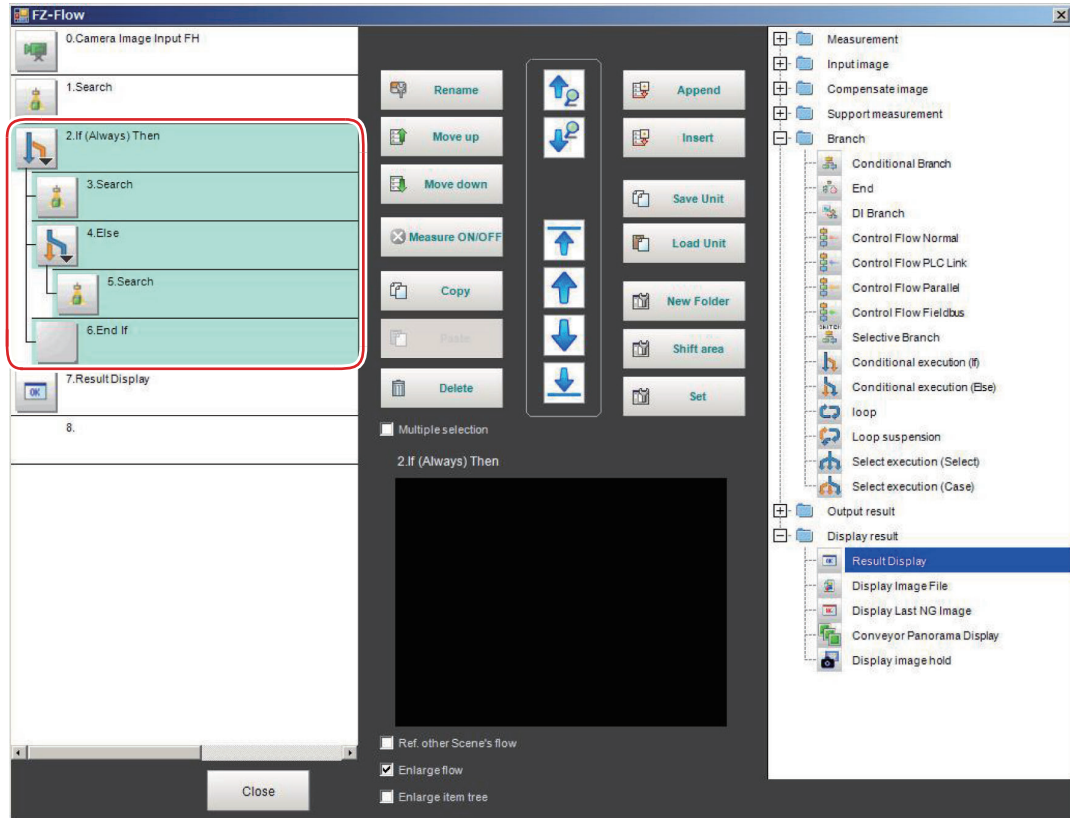

- 2** Click **Set**.
The *If (Always) Then* setting dialog is displayed.

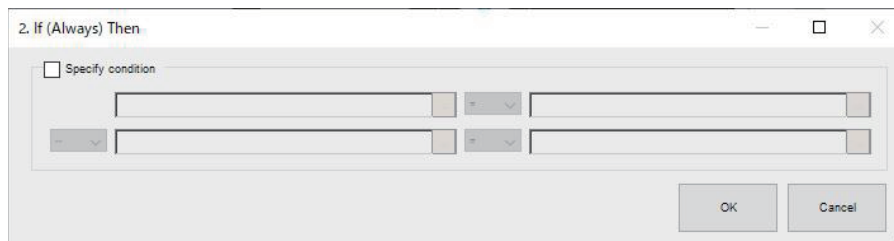

Additional Information

The following operation also display the setting dialog.

- Select the setting target processing unit on the flow display window in the Main screen, click **property setting** icon in the upper right of the flow display window.

For details, refer to the *Main Window (Layout 0): Adjustment Window (Default)* in the *the Vision System FH/FHV Series User's Manual (Cat. No. Z365)*.

- In the *TDM editor*, select the processing unit you want to configure and click **Set - Open the unit setting UI**.

- 3** Set the conditions.
Set the conditions by following the description below.

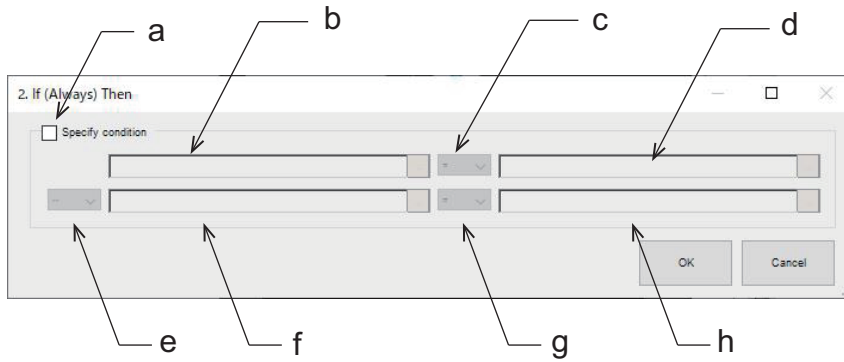

- a) Conditions setting check box:
 Checked: When the conditions are met (true), the Conditional Execution block will be executed.
 Unchecked: Regardless of the conditions, the Conditional Execution block will be executed.
- b) Condition input box (expression A0):
 Set the conditions with a calculation expression.
 For details, refer to 4-3-3 *Layout of Setting Expression Window (Calculation)* on page 4-12.
- c) Comparison condition selection box:
 Compare the expression A0 (b condition) and expression B0 (d condition).

Comparison operator	Description
=	When the value of the expression A0 equals that of the expression B0, then "true".
≤	When the value of the expression A0 is no more than that of the expression B0, then "true".
<	When the value of the expression A0 is less than that of the expression B0, then "true".
≥	When the value of the expression A0 is no less than that of the expression B0, then "true".
>	When the value of the expression A0 is more than that of the expression B0, then "true".
≠	When the value of the expression A0 is not equal to that of the expression B0, then "true".

- d) Condition input box (expression B0):
 Set the conditions with a calculation expression.
 For details, refer to 4-3-3 *Layout of Setting Expression Window (Calculation)* on page 4-12.
- e) Logical operation selection box:
 Set the logical operation conditions for the conditions set in b, c, and d (expression 0), and the conditions set in f, g, and h (expression 1).

Logical operator	Description
-	When the value of expression 0 is true, then "true". The expression 1 is grayed out.
And	When the values of both expression 0 and expression 1 are true, then "true". When either one of them is false, then "false".
Or	Either one or both expression 0 and expression 1 are true, then "true". When both conditions are false, then "false".

- f) Condition input box (expression A1):

Set the conditions with a calculation expression.

For details, refer to 4-3-3 *Layout of Setting Expression Window (Calculation)* on page 4-12.

g) Comparison condition selection box:

Compare expression A1 (f condition) and expression B1 (h condition).

h) Condition input box (expression B1):

Set the conditions with a calculation expression.

For details, refer to 4-3-3 *Layout of Setting Expression Window (Calculation)* on page 4-12.

5-9-2 External Reference Tables (Conditional Execution (If))

No.	Data name	Data ident	Set/Get	Data range
None	Expression A0 result	valueA0	Get only	Result of calculation selected in expression A0
None	Judge	judge	Get only	0: No judgment (unmeasured), 1: Judgment result OK, -1: Judgment result NG, -10: Error (image format mismatch), -11: Error (unregistered model), -12: Error (insufficient memory), -20: Error (other errors)
None	Expression 1 code	conditionType1	Set/Get	0: =, 1: <=, 2: <, 3: >=, 4: >, 5: ≠
None	Expression B0 result	valueB0	Get only	Result of calculation selected in expression B0
None	Result	result	Get only	0: NO, 1: YES
None	Expression B1 result	valueB1	Get only	Result of calculation selected in expression B1
None	Expression A1 result	valueA1	Get only	Result of calculation selected in expression A1
None	Expression B0	expressionB0	Set/Get	Exp. character string
None	Expression A0	expressionA0	Set/Get	Exp. character string
None	Specify condition	specifyCondition	Set/Get	0: OFF, 1: ON
None	Expression 0 code	conditionType0	Set/Get	0: =, 1: <=, 2: <, 3: >=, 4: >, 5: ≠
None	Expression B1	expressionB1	Set/Get	Exp. character string
None	Expression A1	expressionA1	Set/Get	Exp. character string
None	Logical operation	logicalOperation1	Set/Get	0: -, 1: And, 2: Or

5-10 Conditional Execution (Else)

By inserting this processing item between *Conditional Execution (If)* and *Conditional Execution End* processing items, and setting expressions and conditions, the processing in the measurement flow is branched according to the comparison result.

Used in the Following Case

When branching the processing according to the intermediate results of the measurement flow:

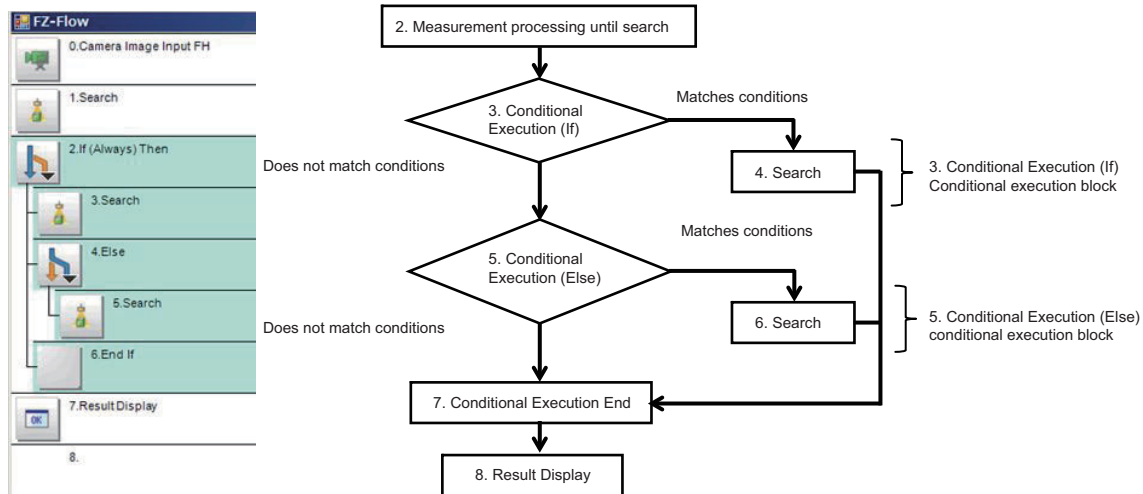

Precautions for Correct Use

- Be sure to pair *Conditional Execution (If)* and *Conditional Execution End* processing items.
- Be sure to insert *Conditional Execution (Else)* processing item between *Conditional Execution (If)* and *Conditional Execution End* processing items.
- When using a *Conditional Branch* processing item within a Conditional Execution block, be sure to locate the branch destination unit within the same Conditional Execution block.
- When using a *Conditional Branch* processing item outside a Conditional Execution block, be sure to avoid locating the branch destination unit within the Conditional Execution block

5-10-1 Conditional Execution Settings (Conditional Execution (Else))

Set the following two settings.

- Flow settings to perform *Conditional Execution (Else)* processing item (Conditional Execution block settings).
- Conditions settings to be performed in *Conditional Execution (Else)*.

Setting the Flow to Perform (Conditional Execution Block Settings)

Set the flow (Conditional Execution Block) to perform when conditions are met between the *Conditional Execution (Else)* and *Conditional Execution End* processing items.

- 1 In the Edit Flow window, add the *Conditional Execution (Else)* processing item between the *Conditional Execution (If)* and *Conditional Execution End* processing items.

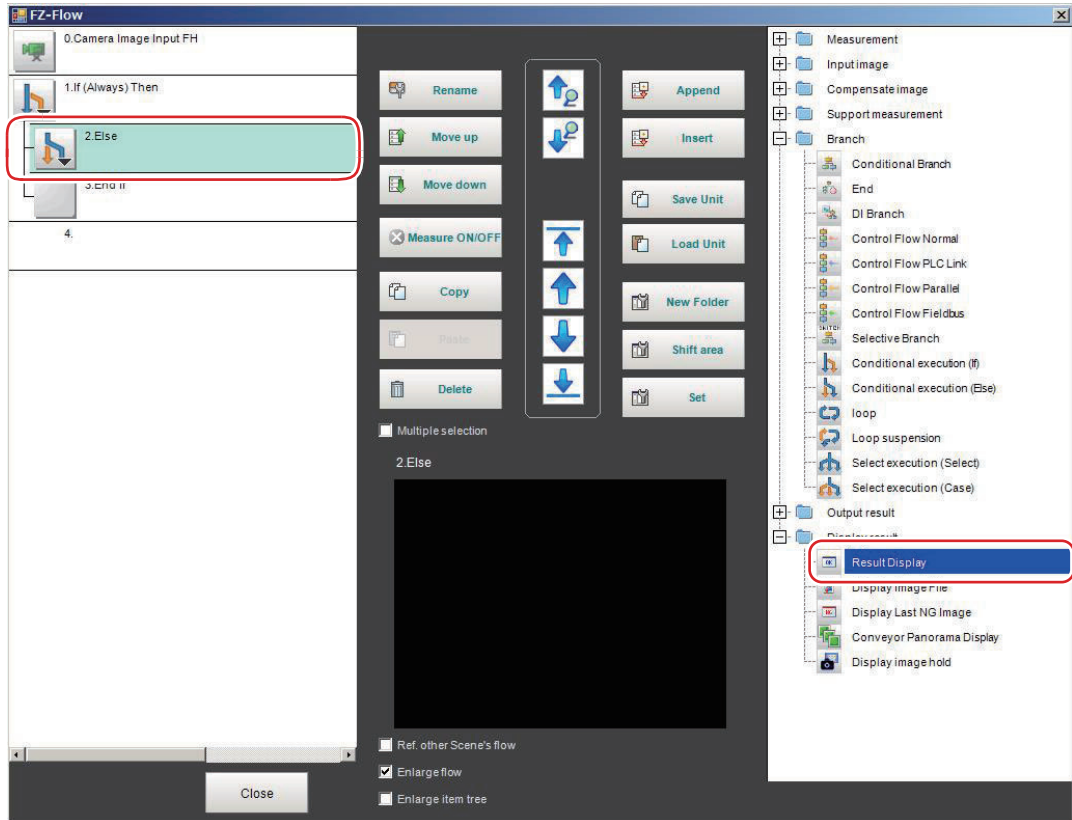

- 2 Set the Conditional Execution Block between the *Conditional Execution (Else)* and *Conditional Execution End* processing items.

Setting Conditions

Set the condition details and comparison conditions.

- 1 In the Edit Flow window, select the *Conditional Execution (Else)* processing item to set conditions.
Selected *Conditional Execution (Else)* processing item and the Conditional Execution Block will be selected.

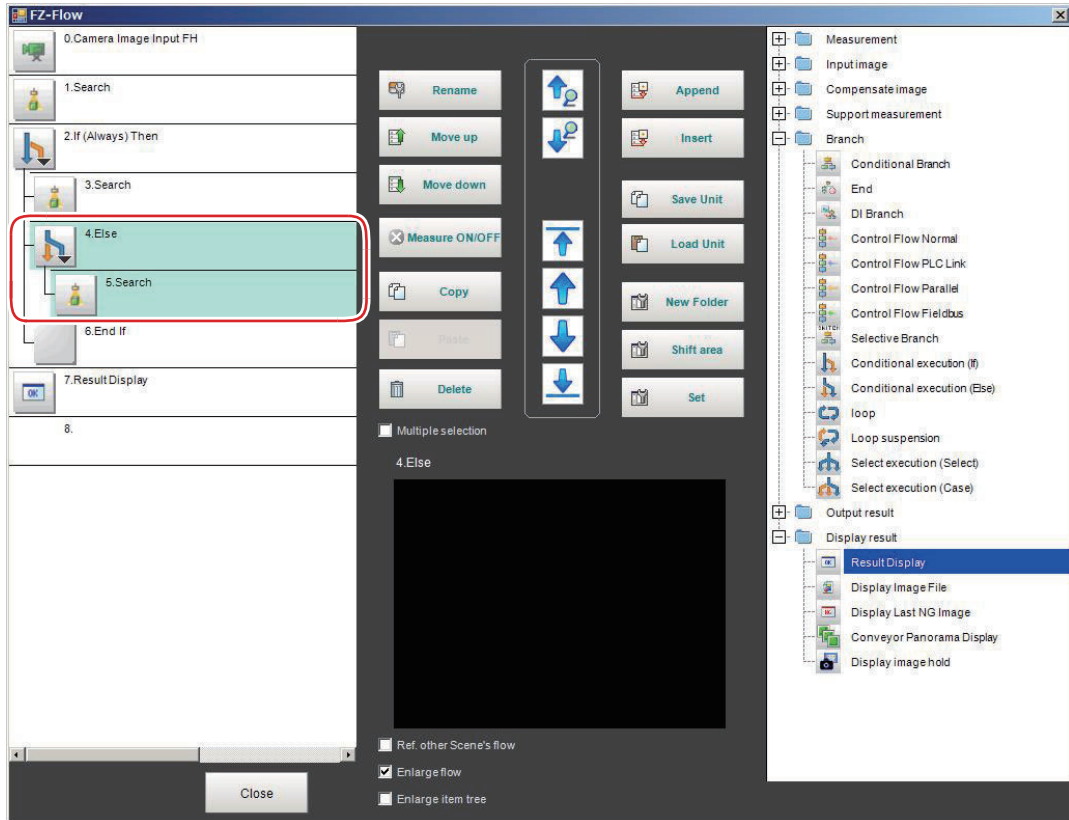

2 Click **Set**.

The *Conditional Execution (Else)* setting dialog is displayed.

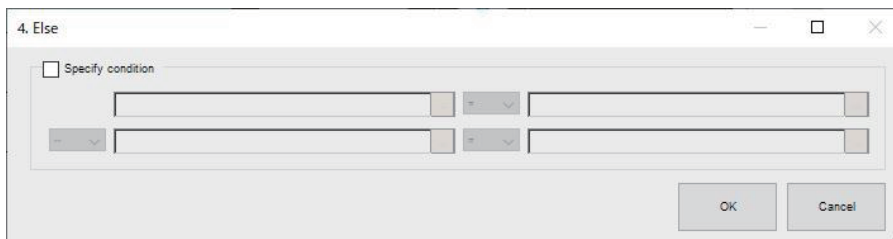

Additional Information

The following operation also display the setting dialog.

- Select the setting target processing unit on the flow display window in the Main screen, click **property setting** icon in the upper right of the flow display window.
For details, refer to the *Main Window (Layout 0): Adjustment Window (Default)* in the *the Vision System FH/FHV Series User's Manual (Cat. No. Z365)*.
- In the *TDM editor*, select the processing unit you want to configure and click **Set - Open the unit setting UI**.

3 Set conditions.

Set the conditions by following the description below.

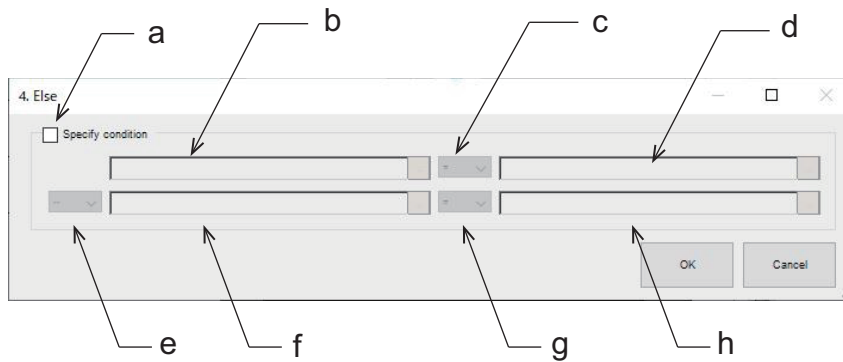

- a) Conditions setting check box:
 Checked: When the set conditions are met (true), the Conditional Execution Block will be executed.
 Unchecked: Regardless of the conditions, the Conditional Execution Block will be executed.
- b) Condition input box (expression A0):
 Set the conditions with a calculation expression.
 For details, refer to *4-3-3 Layout of Setting Expression Window (Calculation)* on page 4-12.
 For details, refer to *4-3-3 Layout of Setting Expression Window (Calculation)* on page 4-12.
- c) Comparison condition selection box:
 Compare the expression A0 (b condition) and expression B0 (d condition).

Comparison operator	Description
=	When the value of the expression A0 equals that of the expression B0, then "true".
≤	When the value of the expression A0 is no more than that of the expression B0, then "true".
<	When the value of the expression A0 is less than that of the expression B0, then "true".
≥	When the value of the expression A0 is no less than that of the expression B0, then "true".
>	When the value of the expression A0 is more than that of the expression B0, then "true".
≠	When the value of the expression A0 is not equal to that of the expression B0, then "true".

- d) Condition input box (expression B0):
 Set the conditions with a calculation expression.
 For details, refer to *4-3-3 Layout of Setting Expression Window (Calculation)* on page 4-12.
- e) Logical operation selection box:
 Set the logical operation conditions for the conditions set in b, c, and d (expression 0), and the conditions set in f, g, and h (expression 1).

Logical operator	Description
-	When the value of expression 0 is true, then "true". The expression 1 is grayed out.
And	When the values of both expression 0 and expression 1 are true, then "true". When either one of them is false, then "false".
Or	Either one or both expression 0 and expression 1 are true, then "true". When both conditions are false, then "false".

- f) Condition input box (expression A1):
Set the conditions with a calculation expression.
For details, refer to *4-3-3 Layout of Setting Expression Window (Calculation)* on page 4-12.
- g) Comparison condition selection box:
Compare expression A1 (f condition) and expression B1 (h condition).
- h) Condition input box (expression B1):
Set the conditions with a calculation expression.
For details, refer to *4-3-3 Layout of Setting Expression Window (Calculation)* on page 4-12.

5-10-2 External Reference Tables (Conditional Execution (Else))

No.	Data name	Data ident	Set/Get	Data range
None	Expression A0 result	valueA0	Get only	Result of calculation selected in expression A0
None	Judge	judge	Get only	0: No judgment (unmeasured), 1: Judgment result OK, -1: Judgment result NG, -10: Error (image format mismatch), -11: Error (unregistered model), -12: Error (insufficient memory), -20: Error (other errors)
None	Expression 1 code	conditionType1	Set/Get	0: =, 1: <=, 2: <, 3: >=, 4: >, 5: ≠
None	Expression B0 result	valueB0	Get only	Result of calculation selected in expression B0
None	Result	result	Get only	0: NO, 1: YES
None	Expression B1 result	valueB1	Get only	Result of calculation selected in expression B1
None	Expression A1 result	valueA1	Get only	Result of calculation selected in expression A1
None	Expression B0	expressionB0	Set/Get	Exp. character string
None	Expression A0	expressionA0	Set/Get	Exp. character string
None	Specify condition	specifyCondition	Set/Get	0: OFF, 1: ON
None	Expression 0 code	conditionType0	Set/Get	0: =, 1: <=, 2: <, 3: >=, 4: >, 5: ≠
None	Expression B1	expressionB1	Set/Get	Exp. character string
None	Expression A1	expressionA1	Set/Get	Exp. character string
None	Logical operation	logicalOperation1	Set/Get	0: -, 1: And, 2: Or

5-11 Loop

The processing item repeats the set processing. after the number of repeats reaches the loop count specified, then the processing moves to the following processing.

Used in the Following Case

When repeating processing until the conditions are met:

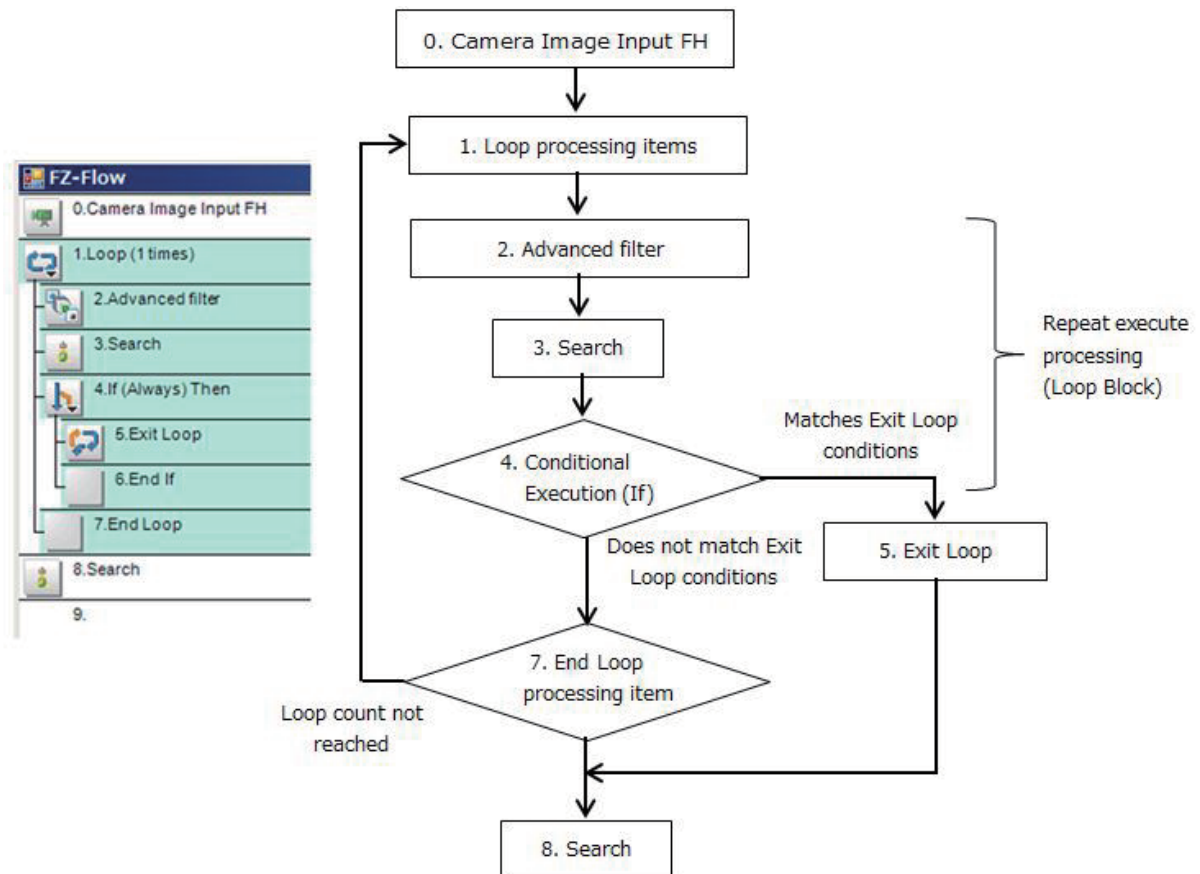

Precautions for Correct Use

- Be sure to pair the *Loop* and *End Loop* processing items.
- Processing can break out of the loop only when the loop count is reached or the *Exit Loop* processing item is processed.
- To break out of the loop, use the *Exit Loop* processing item. If the *Conditional Branch* is used to break out of the loop, the loop count cannot be initialized, therefore the count is not properly performed accurately.
- Be sure to insert the *Exit Loop* processing item between the *Loop* and *End Loop* processing items.
- When the *Conditional Branch* processing item is used within a loop block, be sure to locate the branch destination unit within the same loop block.
- When the *Conditional Branch* processing item is used out of a loop block, be sure not to locate the branch destination unit within the same loop block.

5-11-1 Loop detail settings (Loop)

Set the following two settings.

- Flow settings to perform in the *Loop* processing item (Loop block settings)
- *Loop* count settings

Setting the Flow to Repeatedly Perform Loop Block Settings)

Set the flow (Loop Block) to repeatedly perform between the *Loop* and *End Loop* processing items.

- 1 In the Edit Flow window, add the *Loop* processing item to the flow. The *Loop* and *End Loop* processing items are added to the flow as a pair.

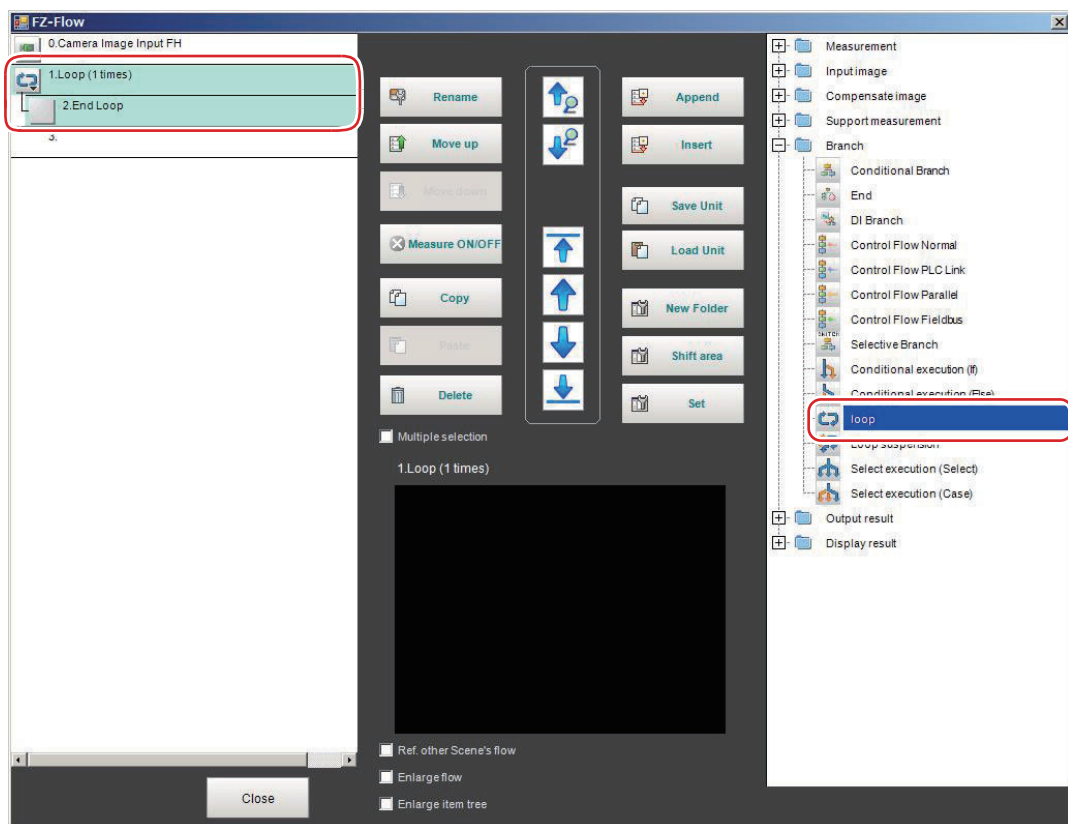

- 2 Set the Loop Block including processing items necessary for measurement between the *Loop* and *End Loop* processing items.

Setting the Loop Count

Set the loop count for the loop block.

- 1 In the Edit Flow window, select the *Loop* processing item to set the loop count. Processing items from the selected *Loop* to the *End Loop* are selected.

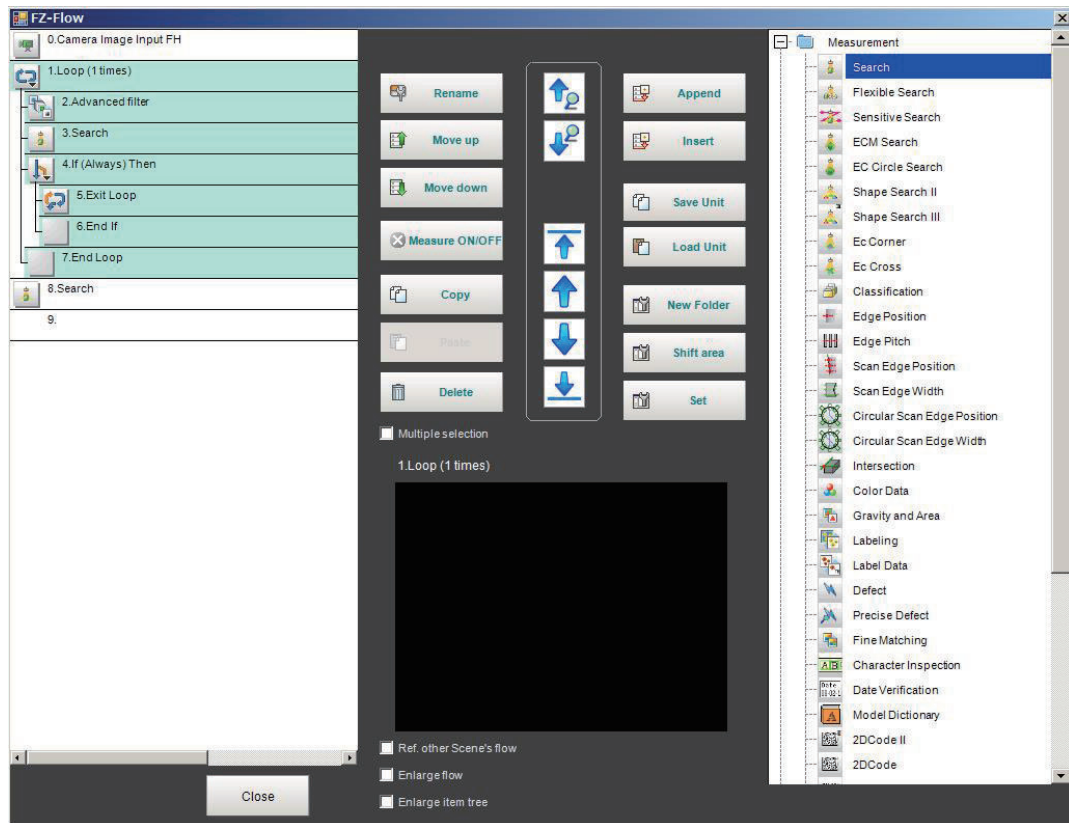

- 2** Click **Set**.
The setting dialog is displayed.

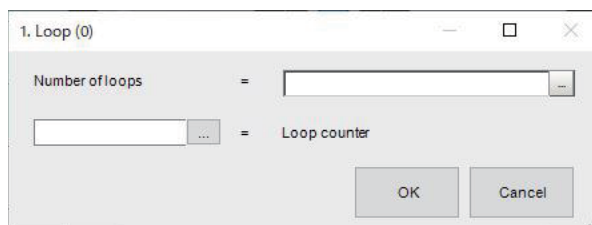

Additional Information

The following operation also display the setting dialog.

- Select the setting target processing unit on the flow display window in the Main screen, click **property setting** icon in the upper right of the flow display window.
For details, refer to the *Main Window (Layout 0): Adjustment Window (Default)* in the *the Vision System FH/FHV Series User's Manual (Cat. No. Z365)*.
- In the *TDM editor*, select the processing unit you want to configure and click **Set - Open the unit setting UI**.

- 3** Set the loop count, and click **OK**.

Setting item	Setting value [Factory default]	Description
Number of loops	0 to 2,147,483,647 [0]	Sets the loop count. The loop count is incremented from 0.

Setting item	Setting value [Factory default]	Description
Loop counter	-	The set number of loops. Click the button to the left of the Loop counter to open the variable assignment screen and assign a variable to the Loop counter.

5-11-2 External Reference Tables (Loop)

No.	Data name	Data ident	Set/Get	Data range
None	Loop counter	CNT	Get only	0 to Number of loops
None	Judge	judge	Get only	0: No judgment (unmeasured), 1: Judgment result OK, -1: Judgment result NG, -10: Error (image format mismatch), -11: Error (unregistered model), -12: Error (insufficient memory), -20: Error (other errors)
None	Number of loops	loopCount	Set/Get	0 to 2,147,483,647

5-12 Loop Interrupt

This processing item is inserted between the *Loop* and *End Loop* processing items and used to break out of a loop without using the loop count.

When interruption conditions are set within a loop, after the conditions are met, the loop can be broken out even if the loop count is not met.

Used in the Following Case

When breaking out of the loop in the middle of processing which is repeated until conditions are met:

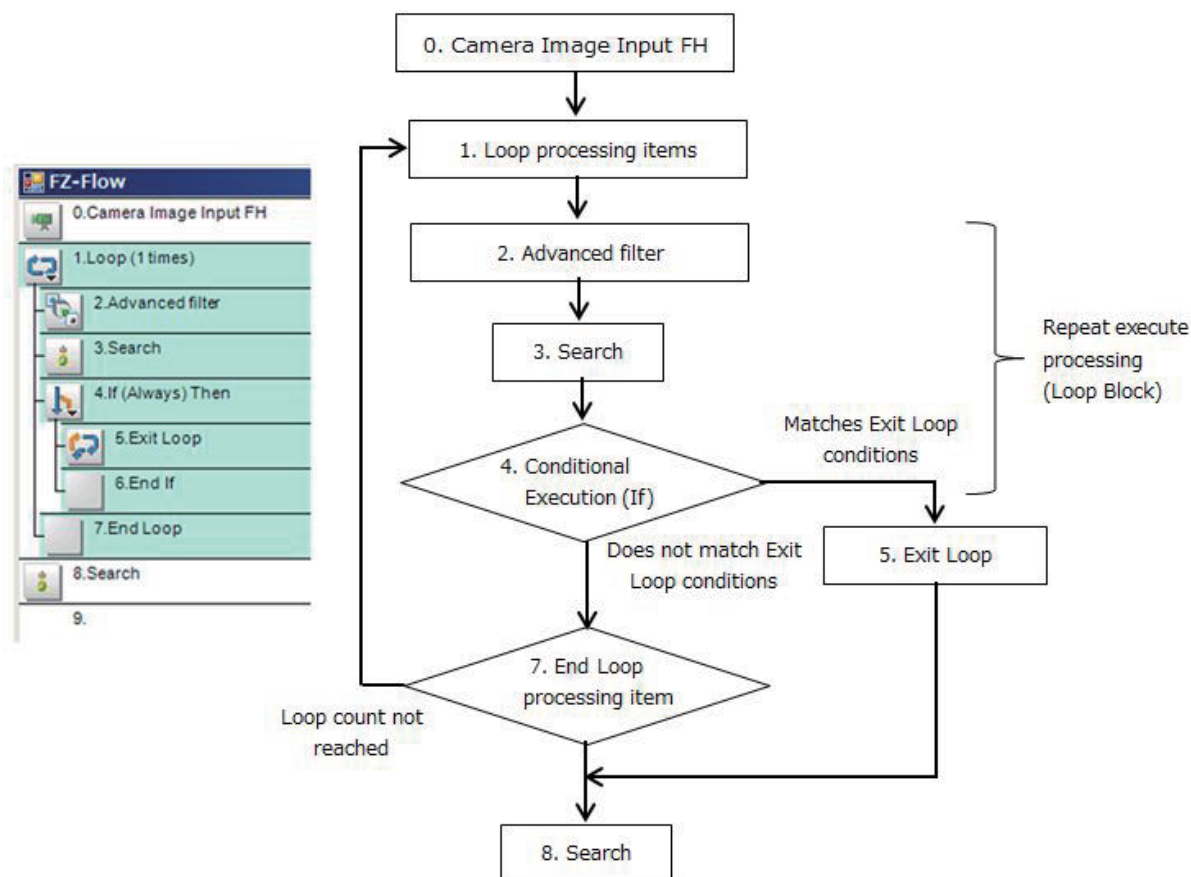

Precautions for Correct Use

- Be sure to pair the *Loop* and *End Loop* processing items.
- Processing can break out of the loop only when the loop count is reached or the *Exit Loop* processing item is processed.
- To break out of the loop, use the *Exit Loop* processing item. If the *Conditional Branch* is used to break out of the loop, the loop count cannot be initialized, therefore the count is not properly performed accurately.
- Be sure to insert the *Exit Loop* processing item between the *Loop* and *End Loop* processing items.
- When the *Conditional Branch* processing item is used within a loop block, be sure to locate the branch destination unit within the same loop block.
- When the *Conditional Branch* processing item is used out of a loop block, be sure not to locate the branch destination unit within the same loop block.

5-12-1 Loop Interrupt Settings (Loop Interrupt)

This processing item enables the current processing to break out of a loop. Just locating this between the *Loop* and *End Loop* processing items completes the settings.

5-12-2 External Reference Tables (Loop suspension)

No.	Data name	Data ident	Set/Get	Data range
None	Judge	judge	Get only	0: No judgment (unmeasured), 1: Judgment result OK, -1: Judgment result NG, -10: Error (image format mismatch), -11: Error (unregistered model), -12: Error (insufficient memory), -20: Error (other errors)

5-13 Select Execution (Select)

By setting conditions using expressions, this processing item branches the measurement flow according to the comparison results.

The conditions are set in the *Select Execution (Select)* processing item, and the *Select Execution (Case)* processing item judges the conditions.

Only integer values can be set as the conditions.

Used in the Following Case

When branching the processing according to the intermediate results of the measurement flow:

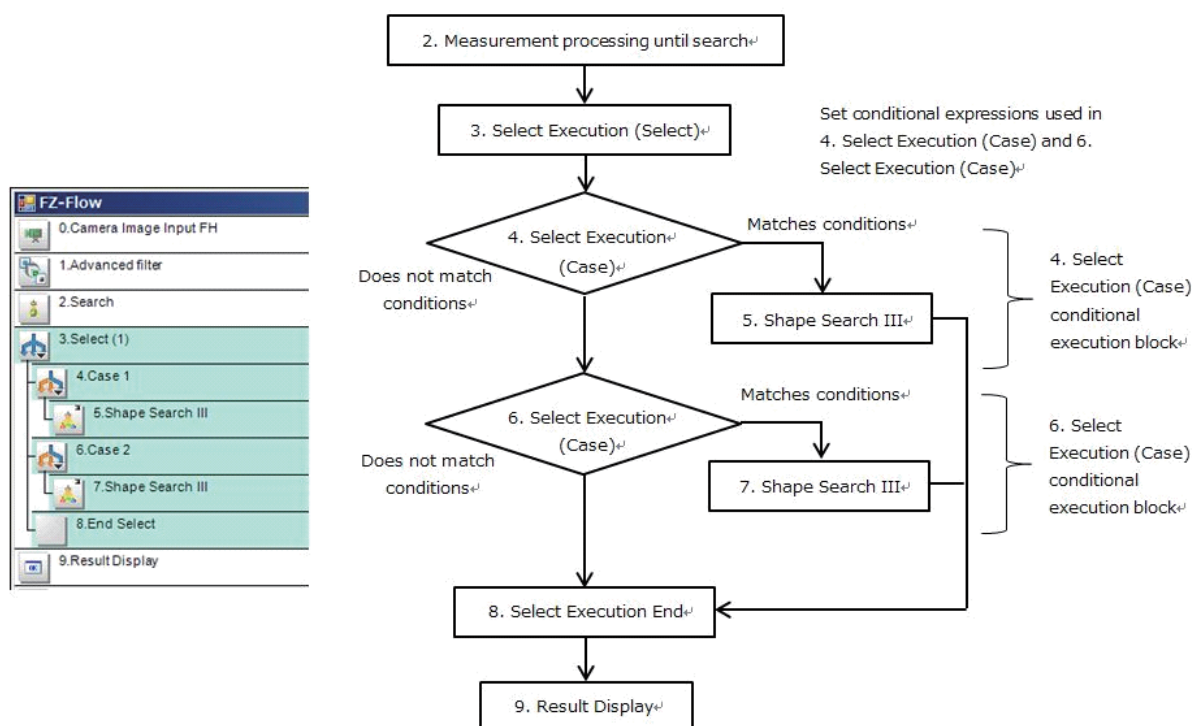

Precautions for Correct Use

- Be sure to pair the *Select Execution (Select)* and *Select Execution End* processing items.
- Be sure to insert the *Select Execution (Case)* processing item between the *Select Execution (Select)* and *Select Execution End* processing items.
- When the *Conditional Branch* processing item is used within a conditional execution block, be sure to locate the branch destination unit within the same conditional execution block.
- When the *Conditional Branch* processing item is used out of a conditional execution block, be sure not to locate the branch destination unit within the same conditional execution block.

5-13-1 Select Execution Setting (Select Execution (Select))

Set which data to be used as the branch conditions.

- 1 In the Edit Flow window, add the *Select Execution (Select)* processing item to the measurement flow.
A total of four processing items are added as a set: the *Select Execution (Select)* x 1, *Select Execution (Case)* x 2, and *Select Execution End* x 1.

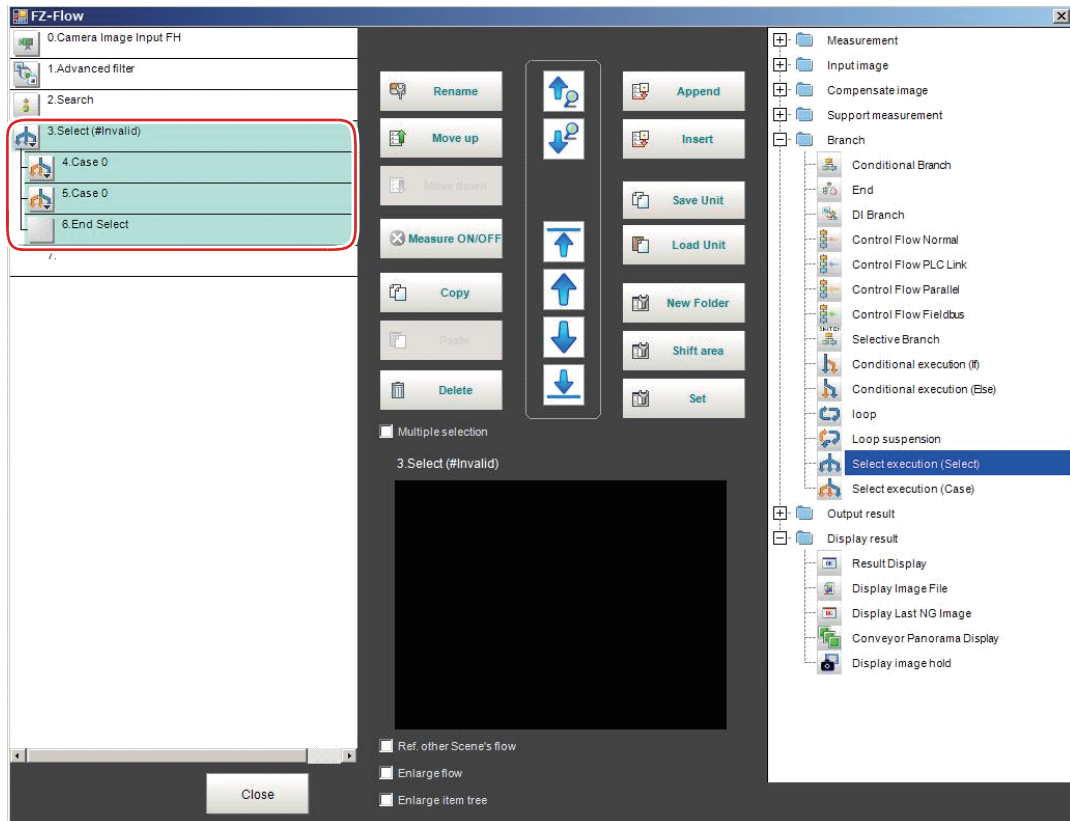

- 2 Set the flow for each Conditional Execution block.
- 3 Select the *Select Execution (Select)* processing item to set the conditions.
The processing items from the *Select Execution (Select)* to *Select Execution End* will be selected.

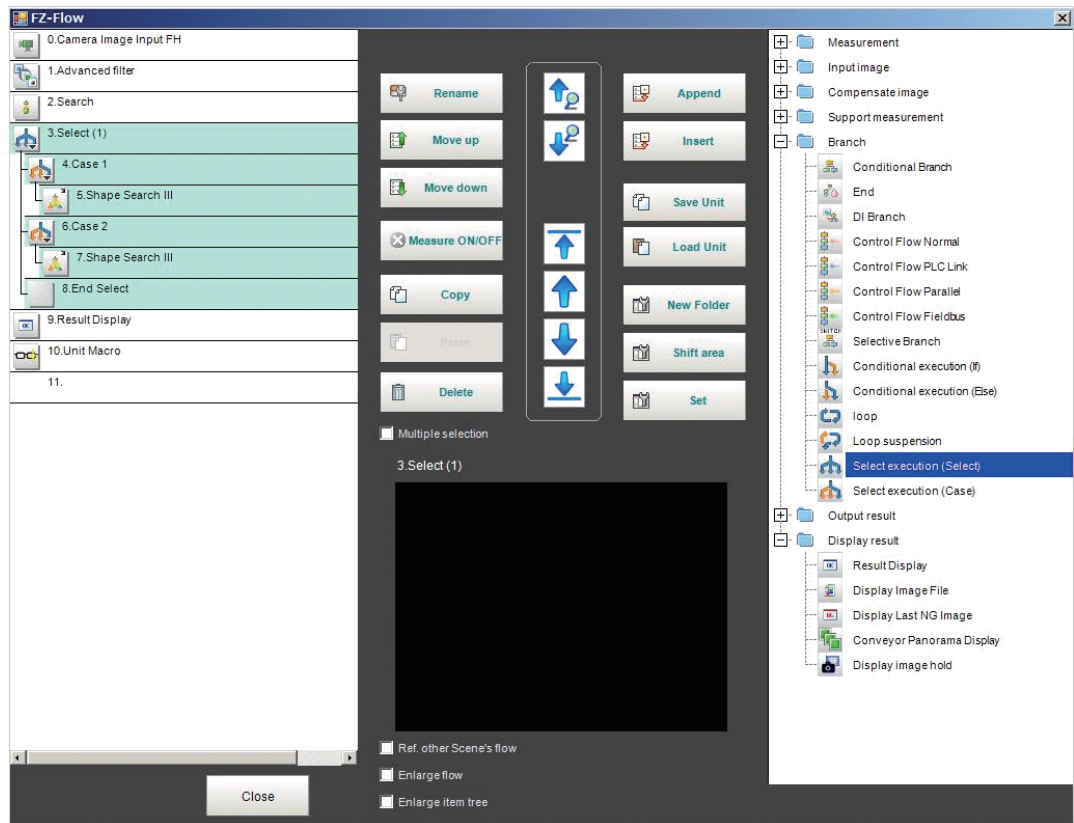

- 4** Click **Set**.
The *Select* setting dialog is displayed.

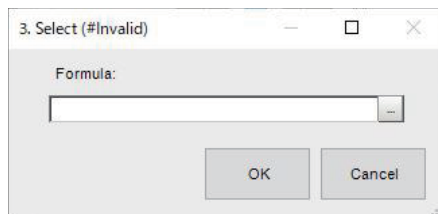

Additional Information

The following operation also display the setting dialog.

- Select the setting target processing unit on the flow display window in the Main screen, click **property setting** icon in the upper right of the flow display window.
For details, refer to the *Main Window (Layout 0): Adjustment Window (Default)* in the *the Vision System FH/FHV Series User's Manual (Cat. No. Z365)*.
- In the *TDM editor*, select the processing unit you want to configure and click **Set - Open the unit setting UI**.

- 5** Click  at the right side of the *Formula* to set conditions.
Set the conditions using a calculation expression.

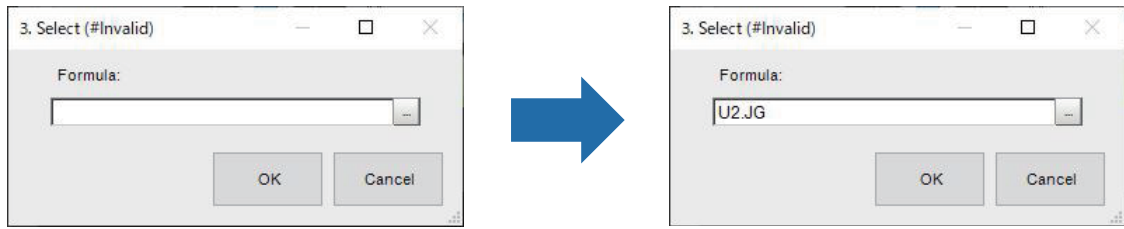

When the conditions are set, the calculation expression for the input conditions will be displayed in the **(#Invalid)** part in the dialog and the processing item.

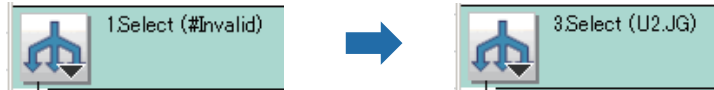

For details, refer to *4-3-3 Layout of Setting Expression Window (Calculation)* on page 4-12. When the value calculated from the set conditions meets the value for one of subsequent *Select Execution (Case)* processing items, the Conditional Execution block will be performed.

5-13-2 External Reference Tables (Select execution (Select))

No.	Data name	Data ident	Set/Get	Data range
None	Expression result	value	Get only	Result of calculation selected in expression
None	Judge	judge	Get only	00: No judgment (unmeasured), 1: Judgment result OK, -1: Judgment result NG, -10: Error (image format mismatch), -11: Error (unregistered model), -12: Error (insufficient memory), -20: Error (other errors)
None	Formula	expression	Set/Get	Exp. character string

5-14 Select Execution (Case)

By setting conditions using expressions, this processing item branches the measurement flow according to the comparison results.

The conditions are set in the *Select Execution (Select)* processing item, and the *Select Execution (Case)* processing item judges the conditions.

Only integer values can be set as the conditions.

Used in the Following Case

When branching the processing according to the intermediate results of the measurement flow:

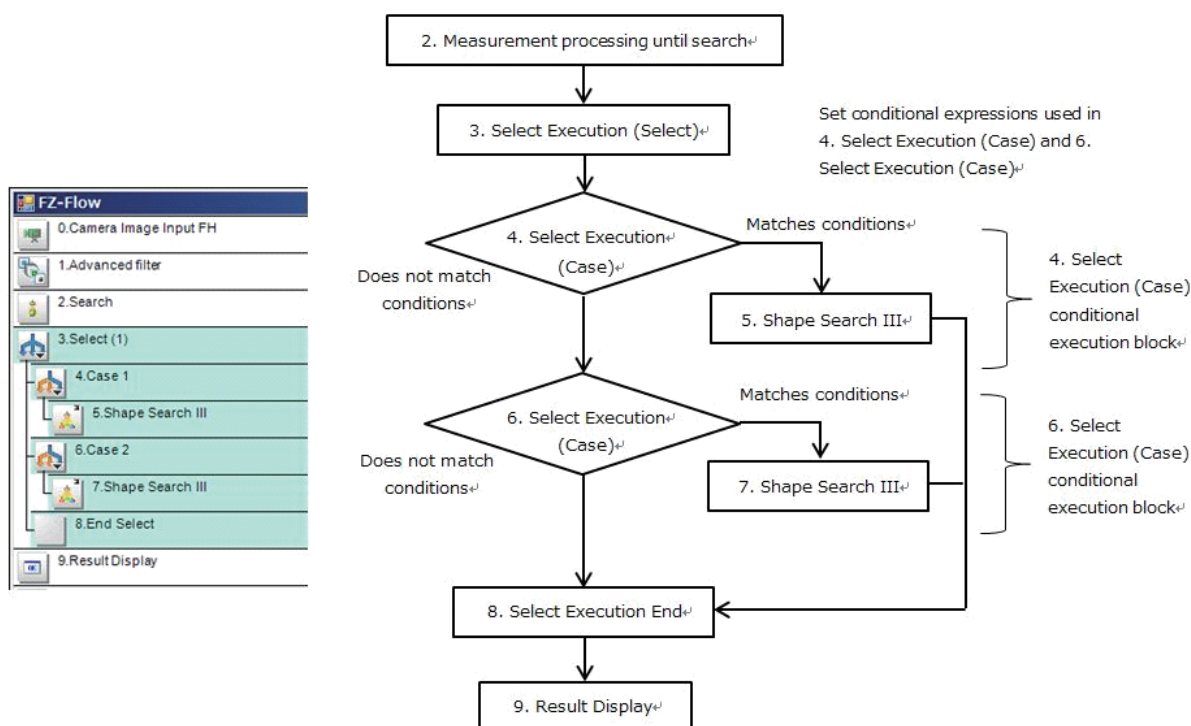

Precautions for Correct Use

- Be sure to pair the *Select Execution (Select)* and *Select Execution End* processing items.
- Be sure to insert the *Select Execution (Case)* processing item between the *Select Execution (Select)* and *Select Execution End* processing items.
- When the *Conditional Branch* processing item is used within a conditional execution block, be sure to locate the branch destination unit within the same conditional execution block.
- When the *Conditional Branch* processing item is used out of a conditional execution block, be sure not to locate the branch destination unit within the same conditional execution block.

5-14-1 Select Execution Setting (Select Execution (Case))

Set the value to be compared with that set in the *Select Execution (Select)* processing item.

- 1 In the Edit Flow window, add the *Select Execution (Case)* processing item to the measurement flow as necessary.

The *Select Execution (Case)* processing item is added to the flow.

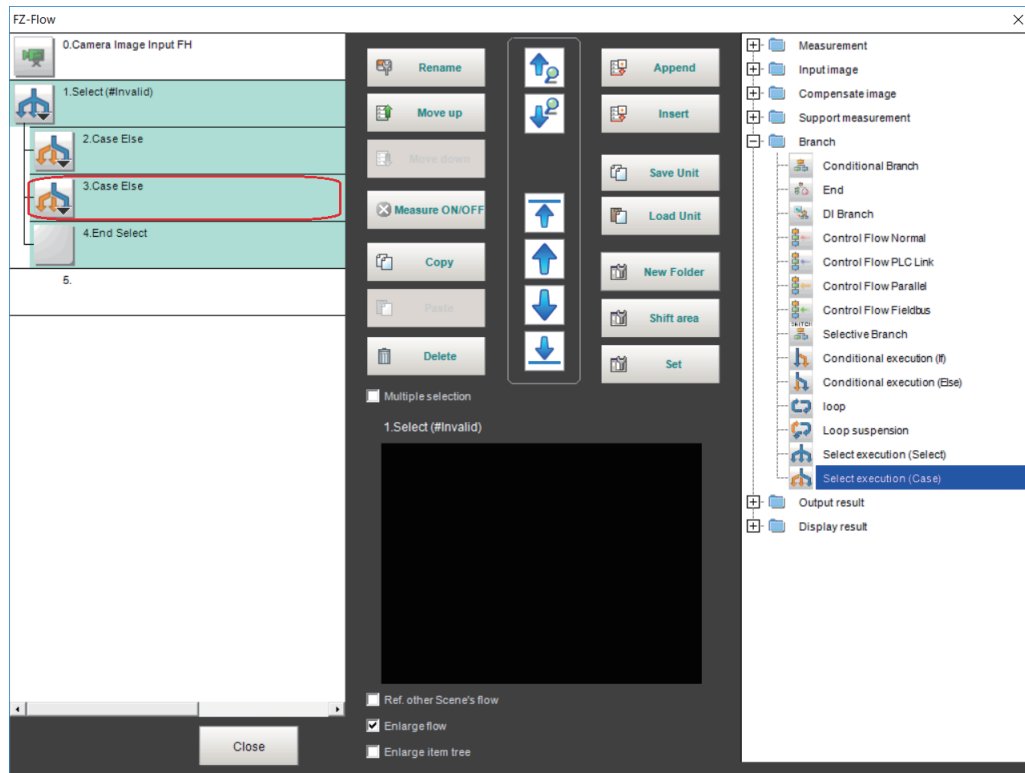

- 2** Set the flow for each Conditional Execution block.
- 3** Select the *Select Execution (Case)* processing item to set the conditions.
the *Select Execution (Case)* processing item and the Conditional Execution block will be selected.

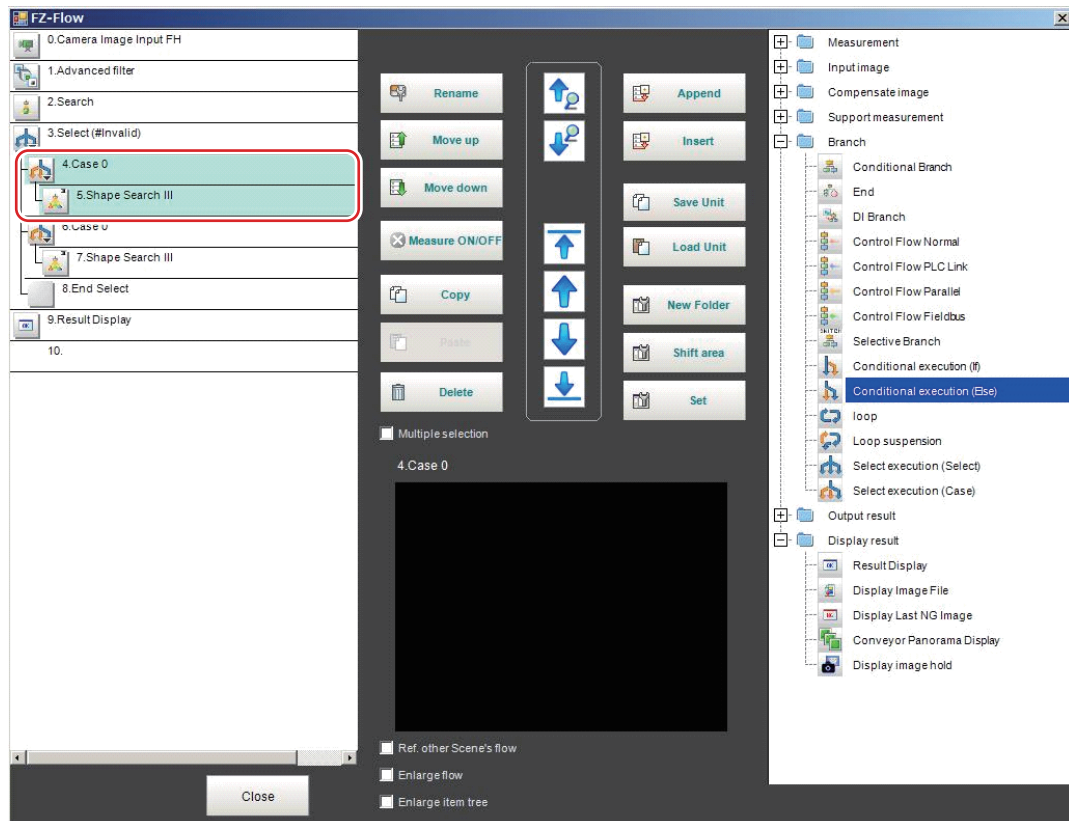

- 4** Click **Set**.
The Case dialog box is displayed.

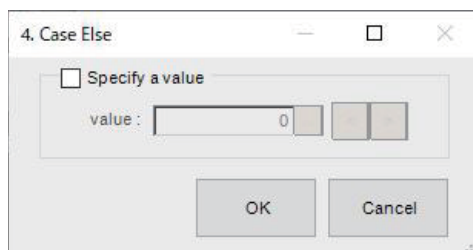

Additional Information

The following operation also display the setting dialog.

- Select the setting target processing unit on the flow display window in the Main screen, click **property setting** icon in the upper right of the flow display window.
For details, refer to the *Main Window (Layout 0): Adjustment Window (Default)* in the *the Vision System FH/FHV Series User's Manual (Cat. No. Z365)*.
- In the *TDM editor*, select the processing unit you want to configure and click **Set - Open the unit setting UI**.

- 5** Place a check at the *Specify a value* and click  at the right side of the *value* to set a value to compare.
When the value set here meets that set in the *Select Execution (Case)* processing item, the Conditional Execution block for the *Select Execution (Case)* will be performed.

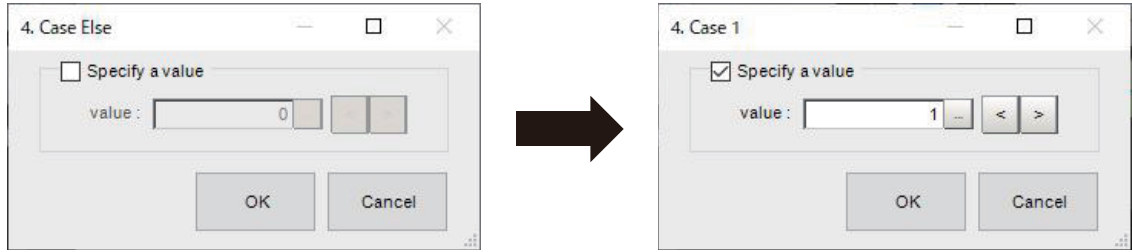

When the value is set, the input value is will be displayed the **Else** part in the dialog and the processing item.



Setting item	Setting value [Factory default]	Description
Specify a value	<ul style="list-style-type: none"> Checked [Unchecked] 	Places a check here to enable to input a value. Sets the value. <ul style="list-style-type: none"> Checked: Compares the input value with the value set in the Select Execution (Select) processing unit. If it met, the Conditional Execution block is processed. Unchecked: The Conditional Execution block is unconditionally processed.
Value	-2147483648 to 2147483647 Refer to data No. 0	This is enabled after the checkbox for the <i>Specify a value</i> is checked. Inputs an integer value to be compared with the value set in the Select Execution (Select) processing item.



Precautions for Correct Use

- When the *Specify a value* is not checked in the *Select Execution (Select)* processing item, the Conditional Execution block is unconditionally processed, and the *Select Execution End* processing item will be performed.
- Only a positive integer value can be set in the *Value*. If a value other than that were set, the judgement in the *Select Execution (Case)* results in a mismatch unconditionally.

5-14-2 External Reference Tables (Select execution (Case))

No.	Data name	Data ident	Set/Get	Data range
None	Judge	judge	Get only	0: No judgment (unmeasured), 1: Judgment result OK, -1: Judgment result NG, -10: Error (image format mismatch), -11: Error (unregistered model), -12: Error (insufficient memory), -20: Error (other errors)
None	value	value	Set/Get	-2,147,483,648 to 2,147,483,647
None	Specify condition	specifyValue	Set/Get	0: OFF, 1: ON

6

Output Result

This chapter describes setting methods when measurement results are output to the external devices.

6-1	Result Output (I/O)	6-2
6-1-1	External Reference Tables (Result output (I / O)).....	6-2
6-2	Result Output (Message)	6-3
6-2-1	External Reference Tables (Result output (Message)).....	6-5
6-3	Result Output (Result Output (Parallel I/O))	6-6
6-3-1	External Reference Tables (Result Output (Parallel I/O)).....	6-6
6-4	Data Output	6-7
6-4-1	External Reference Tables (Data Output).....	6-7
6-5	Parallel Data Output	6-9
6-5-1	External Reference Tables (Parallel Data Output).....	6-9
6-6	Parallel Judgement Output	6-10
6-6-1	External Reference Tables (Parallel Judgement Output).....	6-10
6-7	Fieldbus Data Output	6-12
6-7-1	External Reference Tables (Fieldbus Data Output)	6-12

6-1 Result Output (I/O)

Used in the Following Case

Output data to the external devices such as a programmable controller or a PC via PLC Link or Fieldbus interface (EtherCAT, EtherNet/IP (except message communications), and PROFINET).

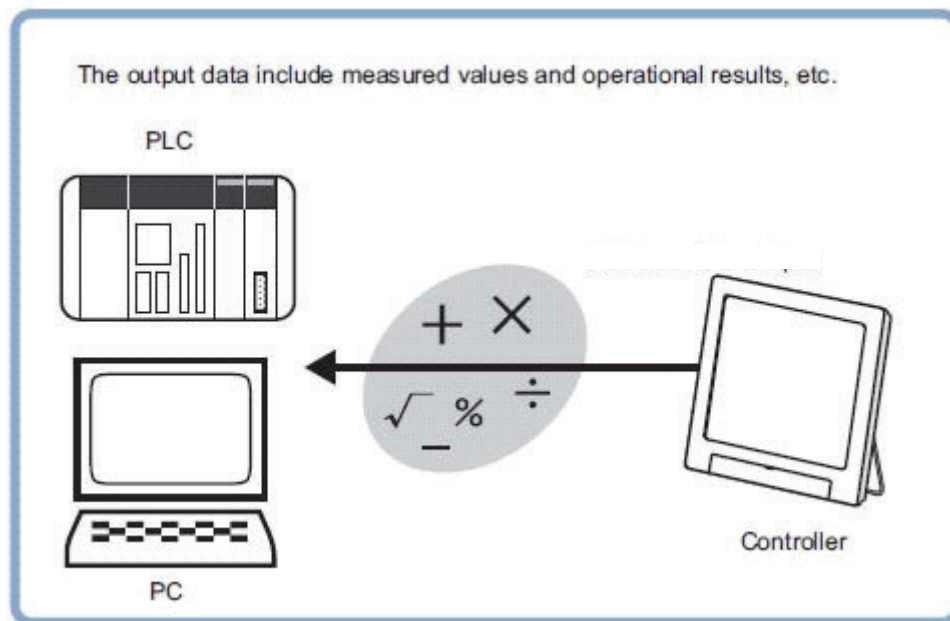

The settings for the PLC link and Fieldbus, refer to *Methods for Connecting and Communicating with External Devices* in the *Vision System FH/FHV Series User's Manual for Communications Settings* (Cat. No. Z342).

6-1-1 External Reference Tables (Result output (I / O))

No.	Data name	Data ident	Set/Get	Data range
None	Title of output data	title	Set/Get	String
None	Judge	judge	Get only	0: No judgment (unmeasured), 1: Judgment result OK, -1: Judgment result NG, -10: Error (image format mismatch), -11: Error (unregistered model), -12: Error (insufficient memory), -20: Error (other errors)
None	Output device	ioident	Set/Get	IoModule2: Serial (Ethernet), IoModule1: Serial (RS-232C/422), IoModule3: Fieldbus
None	Output data	output	Set/Get	String

6-2 Result Output (Message)

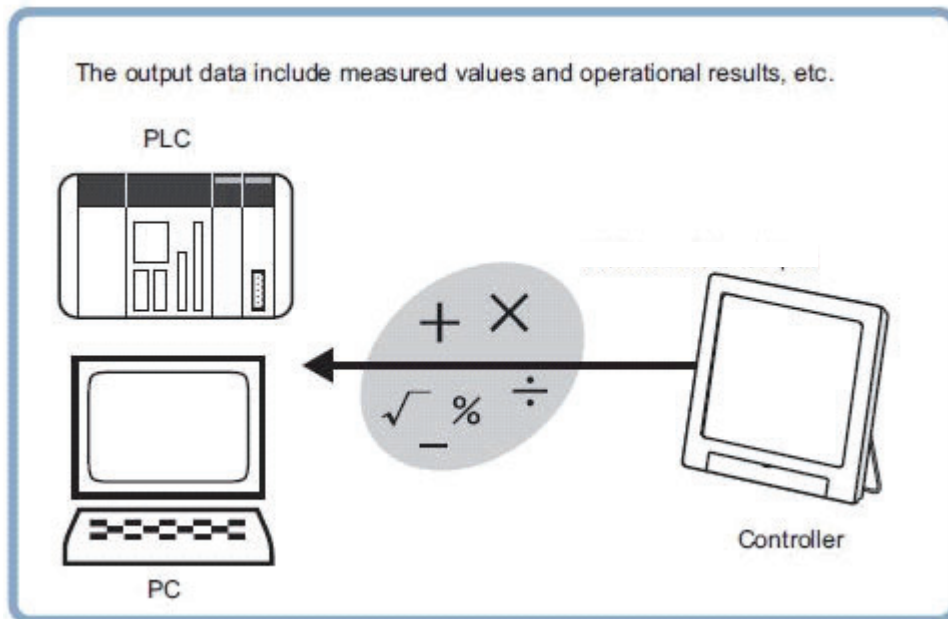

Used in the Following Case

Output data to the external devices such as a programmable controller or a PC with non-procedure mode via the serial interface or Ethernet (message communications). This processing item allows you to save the logging data as a “.csv” file into the Sensor Controller as well.



The settings for the serial data output with non-procedure protocol, refer to *Methods for Connecting and Communicating with External Devices* in the *Vision System FH/FHV Series User's Manual for Communications Settings (Cat. No. Z342)*.

Saving Logging Data

- 1 On the Main window, click **Edit flow** in the Tool bar.
- 2 Click **Result Output (Message)** from the processing item tree.
- 3 Click **Append**.
- 4 Click  icon of the **Result Output (Message)** or  to set the output setting and output item data.
Result Output (Message) setting window is displayed.

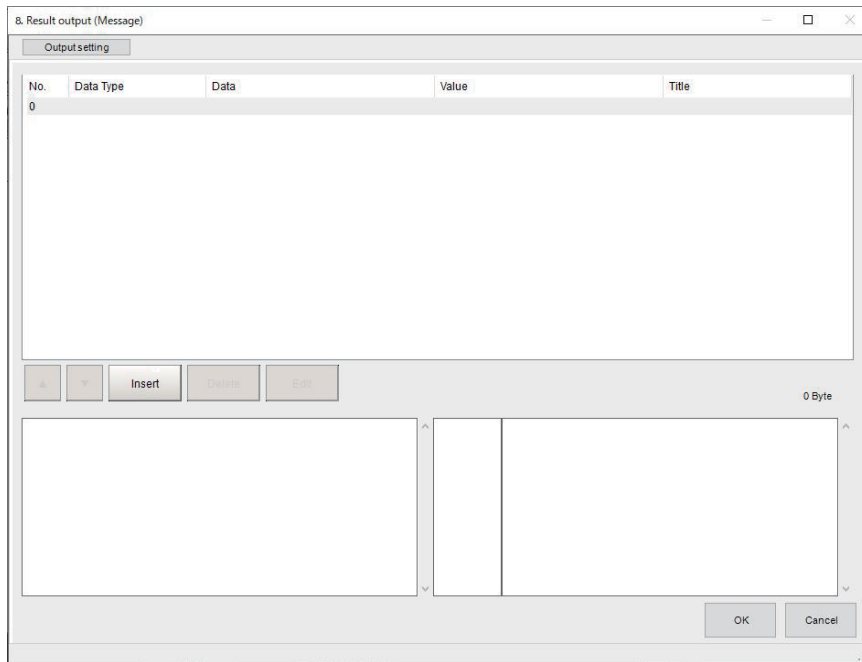

- 5** Click on the **Output setting** tab.
The **Output setting** screen appears.

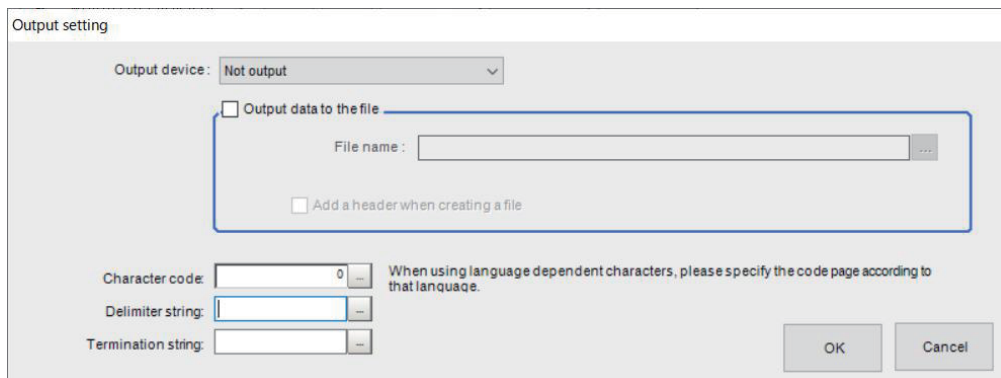

- 6** Click  at the right side of the **Output device** text box.
- Select *Serial (Ethernet)* or *Serial (RS-232C/422)* according to communication protocols when outputting character strings together in non-procedure protocol.
 - Select *Not output* when executing only the data logging.

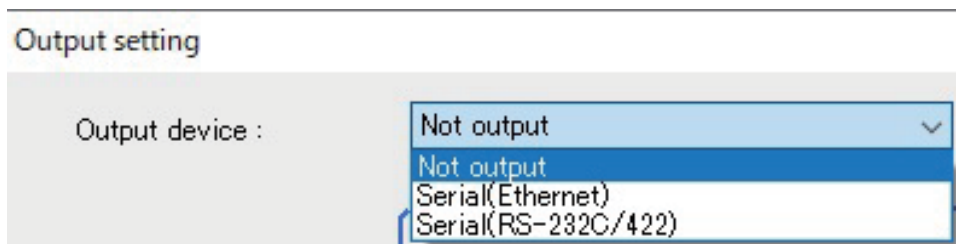

- 7** Place a check in the check box for the *Output data to the file* when executing the data logging.
The following part will be enabled.

Contents entered in *Title* on the *Output data editing* dialog in the **Output data** tab will be inserted in the first line of logged data when placing a check in the check box for the *Add a header when creating a file*.

- 8** Click  at the right side of the **File name** text box. *FileExplorer* will appear.
- 9** Specify a .CSV file to be used in the data logging or enter a file name and click **OK**.
- 10** Click **OK** to end the setting.



Additional Information

- A byte-order-mark BOM (0xEF 0xBB 0xBF) will be added in the head of the file when specifying "UTF-8" for the character code.
- This data logging has no dependency with **Data logging** on the **Logging setting** in the **System settings**. The data logged is always output when *Output data to the file* is checked.

6-2-1 External Reference Tables (Result output (Message))

No.	Data name	Data ident	Set/Get	Data range
None	Output data	output	Set/Get	String
None	Termination string	terminator	Set/Get	String
None	Judge	judge	Get only	0: No judgment (unmeasured), 1: Judgment result OK, -1: Judgment result NG, -10: Error (image format mismatch), -11: Error (unregistered model), -12: Error (insufficient memory), -20: Error (other errors)
None	Title of output data	title	Set/Get	String
None	Delimiter string	separator	Set/Get	String
None	File name	fileName	Set/Get	String
None	Output device	ioident	Set/Get	IoModule2: Serial (Ethernet), IoModule1: Serial (RS-232C/422)
None	Character code:	codePage	Set/Get	When using language-dependent characters, specify a code page according to the language.
None	Add a header when creating a file	fileHeader	Set/Get	0: Not output, 1: Output

6-3 Result Output (Result Output (Parallel I/O))

Used in the Following Case

Used when outputting measurement results or judgment results to external devices such as a programmable controller or a PC via the parallel interface.

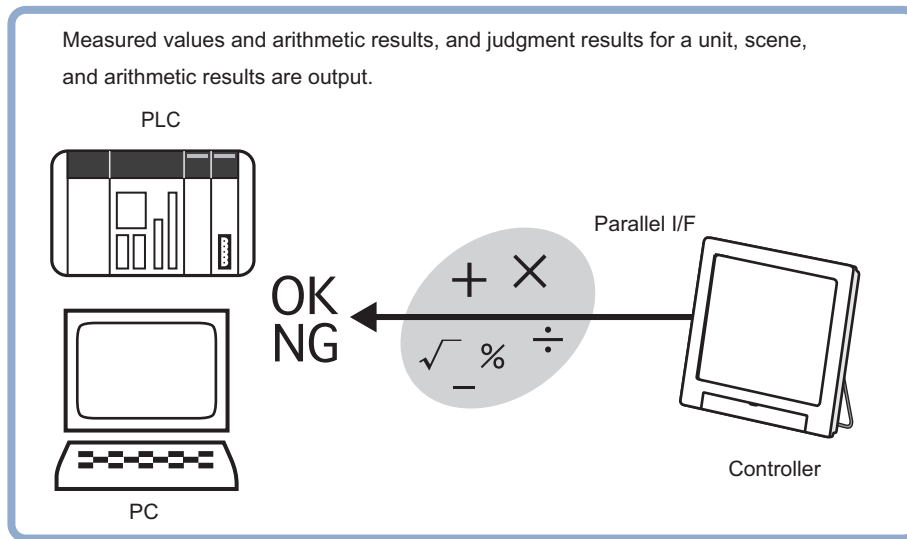

The settings for the parallel interface, refer to *Methods for Connecting and Communicating with External Devices - Parallel Communications* in the *Vision System FH/FHV Series User's Manual for Communication Settings* (Cat. No. Z342).

6-3-1 External Reference Tables (Result Output (Parallel I/O))

No.	Data name	Data ident	Set/Get	Data range
None	Judge	judge	Get only	0: No judgment (unmeasured), 1: Judgment result OK, -1: Judgment result NG, -10: Error (image format mismatch), -11: Error (unregistered model), -12: Error (insufficient memory), -20: Error (other error)
None	Output data title	title	Set/Get	String
None	Output data	output	Set/Get	String

6-4 Data Output

This processing item is not available in the FHV series.

Used in the Following Case

Output data to the external devices such as programmable controller and PC with the no-order mode via the serial interface. With serial data output, output starts immediately after the end of processing of serial data output in the flow.

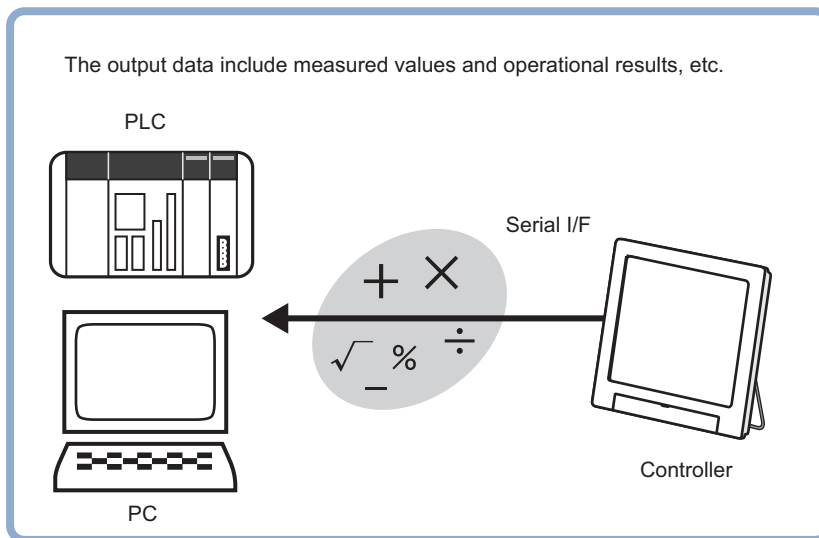

The settings for the serial data output, refer to *Methods for Connecting and Communicating with External Devices* in the *Vision System FH/FHV Series User's Manual for Communications Settings* (Cat. No. Z342).

6-4-1 External Reference Tables (Data Output)

No.	Data name	Data ident	Set/Get	Data range
0	Judge	judge	Get only	0: No judgment (unmeasured), 1: Judgment result OK, -1: Judgment result NG, -10: Error (image format mismatch), -11: Error (unregistered model), -12: Error (insufficient memory), -20: Error (other errors)
136	Communication method	comSelect	Set/Get	0: Ethernet, 1: RS-232C/RS-422 *1
137	Output format	dataFormat	Set/Get	0: ASCII, 1: Binary
138	Integer	integerDigit	Set/Get	1 to 10
139	Decimal	decimalDigit	Set/Get	0 to 4
140	Minus	minusNum	Set/Get	0: -, 1: 8
141	Field separator	fieldSeparator	Set/Get	0: OFF, 1: Comma, 2: Tab, 3: Space, 4: Delimiter

No.	Data name	Data ident	Set/Get	Data range
142	Record separator	recordSeparator	Set/Get	0: OFF, 1: Comma, 2: Tab, 3: Space, 4: Delimiter
143	0 suppress	zeroSuppress	Set/Get	0: OFF, 1: ON
144+N (N=0 to 3)	Output IP address	iPAddress0 to iPA- dress3	Set/Get	Output iPAddress iPAddress1: 1 to 223, iPAddress2 to iPA- dress4: 0 to 255
149	Output IP address setting (only when "Ethernet" is select- ed for the communi- cation method)	iPAddressDiv	Set/Get	0: Reference to system, 1: Individual specification
150	Output form (deci- mal)	decOutputForm	Set/Get	0: Fixed point, 1: Floating point
151	Offset	OutputOffset	Set/Get	0 to 99,999
152	Number of output da- ta items (Valid only for PLClink)	dataNum	Set/Get	8 to 256
153	Plus	plusNum	Set/Get	0: OFF, 1: +
160+N (N=0 to 255)	Comment view	commentView000 to commentView255	Set/Get	0: OFF, 1: ON
1,000+N (N=0 to 255)	Data	resultData000 to re- sultData255	Get only	ASCII: -999,999,999.9999 to 999,999,999.9999, Binary: -2,147,483.648 to 2,147,483.647
2,000+N (N=0 to 255)	Output data	setupData000 to se- tupData255	Set/Get	Exp. character string
3,000+N (N=0 to 255)	Comment about the output data	comment000 to com- ment255	Set/Get	Character string

*1. RS-422 is unavailable in the FH/FHV series.

6-5 Parallel Data Output

This processing item is not available in the FHV series.

Used in the Following Case

Used when outputting data to external devices such as a programmable controller or a PC via the parallel interface.

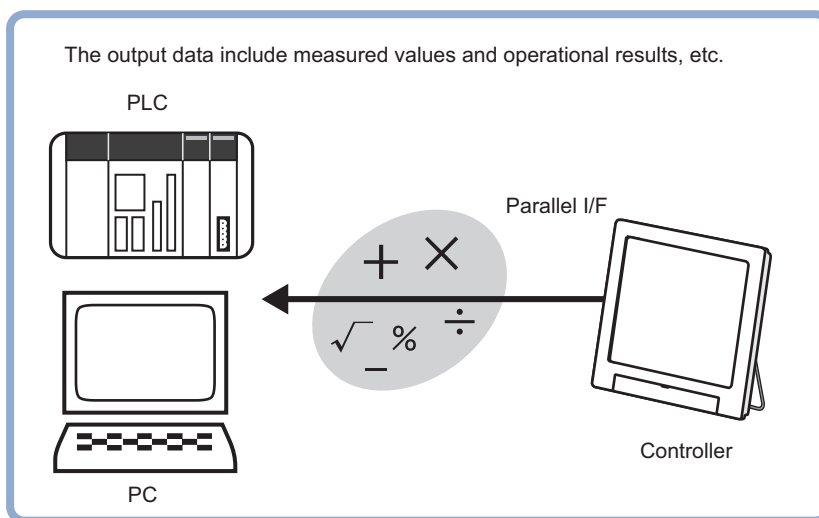

The settings for the parallel data output, refer to *Methods for Connecting and Communicating with External Devices - Parallel Communications* in the *Vision System FH/FHV Series User's Manual for Communications Settings (Cat. no. Z342)*.

6-5-1 External Reference Tables (Parallel Data Output)

No.	Data name	Data ident	Set/Get	Data range
0	Judge	judge	Get only	0: No judgment (unmeasured), 1: Judgment result OK, -1: Judgment result NG, -10: Error (image format mismatch), -11: Error (unregistered model), -12: Error (insufficient memory), -20: Error (other errors)
5+N (N=0 to 7)	Data	resultData0 to resultData7	Get only	Binary: -32,768 to 32,768, BCD: -999 to 999
120+N (N=0 to 7)	Expressions of output data	setupData0 to setupData7	Set/Get	Exp. character string
128	Data type	formatType	Set/Get	0: Binary, 1: BCD
129+N (N=0 to 7)	Comment about the output data	comment0 to comment7	Set/Get	Character string
160+N (N=0 to 7)	Comment view	commentView0 to commentView7	Set/Get	0: OFF, 1: ON

6-6 Parallel Judgement Output

This processing item is not available in the FHV series.

Used in the Following Case

Used when outputting judgement results to external devices such as a programmable controller or PC via the parallel interface.

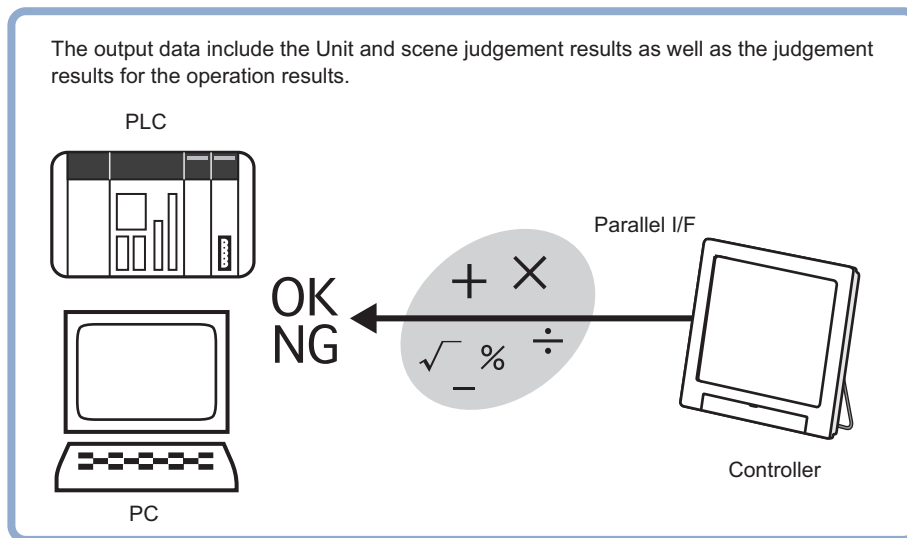

The settings for the parallel judgement output, refer to *Methods for Connecting and Communicating with External Devices - Parallel Communications* in the *Vision System FH/FHV Series User's Manual for Communications Settings (Cat. No. Z342)*.

6-6-1 External Reference Tables (Parallel Judgement Output)

No.	Data name	Data ident	Set/Get	Data range
0	Judge	Judge	Get only	0: No judgment (unmeasured), 1: Judgment result OK, -1: Judgment result NG, -10: Error (image format mismatch), -11: Error (unregistered model), -12: Error (insufficient memory), -20: Error (other errors)
5+N (N=0 to 15)	Data	resultData00 to resultData15	Get only	-999,999,999.9999 to 999,999,999.9999
21+N (N=0 to 15)	Judge	resultJudge00 to resultJudge15	Get only	0: No judgment (unmeasured), 1: Judgment result OK, -1: Judgment result NG
103	Reflect to overall judgement	overallJudge	Set/Get	0: ON, 1: OFF
120+N (N=0 to 15)	Expressions of judgement data	setupData00 to setupData15	Set/Get	Exp. character string

No.	Data name	Data ident	Set/Get	Data range
136+N×2 (N=0 to 15)	Upper limit for judgement	upperCalc00 to upperCalc15	Set/Get	-999,999,999.9999 to 999,999,999.9999
137+N×2 (N=0 to 15)	Lower limit for judgement	lowerCalc00 to lowerCalc15	Set/Get	-999,999,999.9999 to 999,999,999.9999
168+N (N=0 to 15)	Comment about the judgement data	comment00 to comment15	Set/Get	Character string
190+N (N=0 to 15)	Comment view	commentView00 to commentView15	Set/Get	0: OFF, 1: ON
210	Output polarity setting	outputPolaritySetting	Set/Get	0: System (parallel) 1: Unit
211	Output polarity	outputPolarity	Set/Get	0: ON at NG, 1: ON at OK

6-7 Fieldbus Data Output

This processing item is not available in the FHV series.

Used in the Following Case

Used when outputting data to an external device, such as a programmable controller, via the Fieldbus interface.

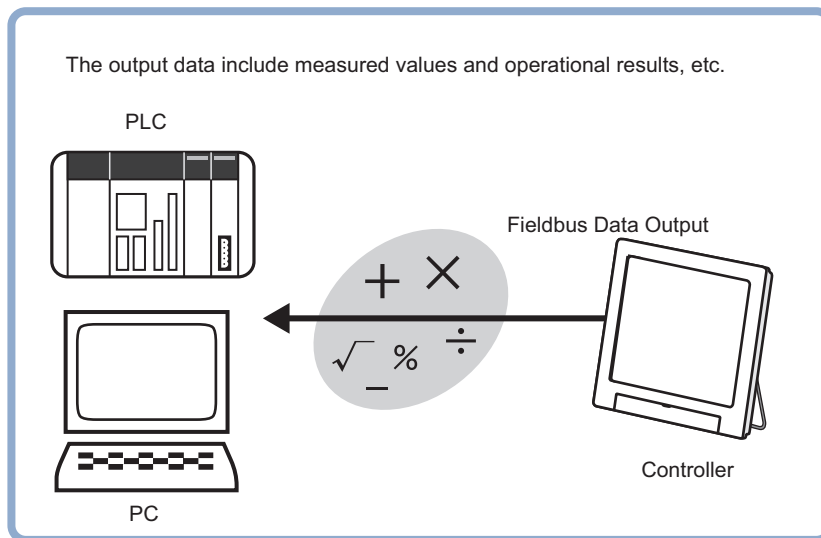

The settings for the Fieldbus data output, refer to *Fieldbus Methods for Connecting and Communicating with External Devices - EtherCAT Connections (FH only)/Communicating with EtherNet/IP in the Vision System FH/FHV Series User's Manual for Communications Settings (Cat. No. Z342)*.

6-7-1 External Reference Tables (Fieldbus Data Output)

No.	Data name	Data ident	Set/Get	Data range
0	Judge	judge	Get only	0: No judgment (unmeasured), 1: Judgment result OK, -1: Judgment result NG, -10: Error (image format mismatch), -11: Error (unregistered model), -12: Error (insufficient memory), -20: Error (other errors)
120+N (N=0 to 7)	Expressions	setupData0 to setupData7	Set/Get	Exp. character string
129+N (N=0 to 7)	Comment	comment0 to comment7	Set/Get	Character string
150	Output form (decimal)	decOutputForm	Set/Get	0: Fixed point , 1: Floating point
1,000+N×10 (N=0 to 63)	Result data (DINT)	resultDataDINT00 to resultDataDINT63	Get only	Result data

No.	Data name	Data ident	Set/Get	Data range
1,001+N×10 (N=0 to 63)	Expressions (DINT)	setupDataDINT00 to setupDataDINT63	Set/Get	Exp. character string
1,002+N×10 (N=0 to 63)	Comment (DINT)	commentDINT00 to commentDINT63	Set/Get	Character string
2,000+N×10 (N=0 to 31)	Result data (LREAL)	resultDataLREAL00 to resultDataL- REAL31	Get only	Result data
2,001+N×10 (N=0 to 31)	Expressions (LREAL)	setupDataLREAL00 to setupDataL- REAL31	Set/Get	Exp. character string
2,002+N×10 (N=0 to 31)	Comment (LREAL)	commentLREAL00 to commentL- REAL31	Set/Get	Character string
3,000+N×10 (N=0 to 7)	Comment display	commentView- NONE0 to comment- ViewNONE7	Set/Get	0: OFF, 1: ON
3,001+N×10 (N=0 to 63)	Comment display (DINT)	commentView- DINT00 to comment- ViewDINT63	Set/Get	0: OFF, 1: ON
3,002+N×10 (N=0 to 31)	Comment display (LREAL)	commentViewL- REAL00 to com- mentViewLREAL31	Set/Get	0: OFF, 1: ON
3,003+N×10 (N=0 to 63)	Comment display (EtherNet/IP)	commentViewEIP00 to commentView- EIP63	Set/Get	0: OFF, 1: ON
4,000+N×10 (N=0 to 63)	Result data (Ether- Net/IP)	resultDataEIP00 to resultDataEIP63	Get only	Result data
4,001+N×10 (N=0 to 63)	Expressions (Ether- Net/IP)	setupDataEIP00 to setupDataEIP63	Set/Get	Exp. character string
4,002+N×10 (N=0 to 63)	Comment (EtherNet/IP)	commentEIP00 to commentEIP63	Set/Get	Character string
5,000+N×10 (N=0 to 63)	Result data (PROFI- NET)	resultDataPRO00 to resultDataPRO63	Get only	Result data
5,001+N×10 (N=0 to 63)	Expressions (PROFI- NET)	setupDataPRO00 to setupDataPRO63	Set/Get	Exp. character string
5,002+N×10 (N=0 to 63)	Comment (PROFI- NET)	commentPRO00 to commentPRO63	Set/Get	Character string
5,003+N×10 (N=0 to 63)	Comment display (PROFINET)	commentView- PRO00 to comment- ViewPRO63	Set/Get	0: OFF, 1: ON



Display Result

This chapter describes how to display strings and figures in the window that displays the measurement results.

7-1	Result Display	7-2
7-1-1	Result Display	7-3
7-1-2	External Reference Tables (Result Display)	7-7
7-2	Display Image File	7-11
7-2-1	Select Image (Display Image File).....	7-11
7-2-2	Key Points for Test Measurement and Adjustment (Display Image File).....	7-12
7-2-3	External Reference Tables (Display Image File).....	7-12
7-3	Display Last NG Image	7-14
7-3-1	NG Error Judgment (Display Last NG Image)	7-14
7-3-2	Image Saving (Display Last NG Image)	7-16
7-3-3	Data Saving (Display Last NG Image).....	7-16
7-3-4	Output parameters (Display Last NG Image)	7-17
7-3-5	Key Points for Test Measurement and Adjustment (Display Last NG Image)	7-17
7-3-6	Measurement Results for Which Output Is Possible (Display Last NG Image)	7-18
7-3-7	External Reference Tables (Display Last NG Image)	7-19
7-4	Conveyor Panorama Display	7-20
7-5	Display Image Hold	7-21
7-5-1	Display Image Retention Settings (Display Image Hold)	7-21
7-5-2	External Reference Tables (Display image hold).....	7-22

7-1 Result Display

Used in the Following Case

For your convenience in verifying measurement results, text and figures will be displayed in the "Image display" area.

The following content can be displayed.

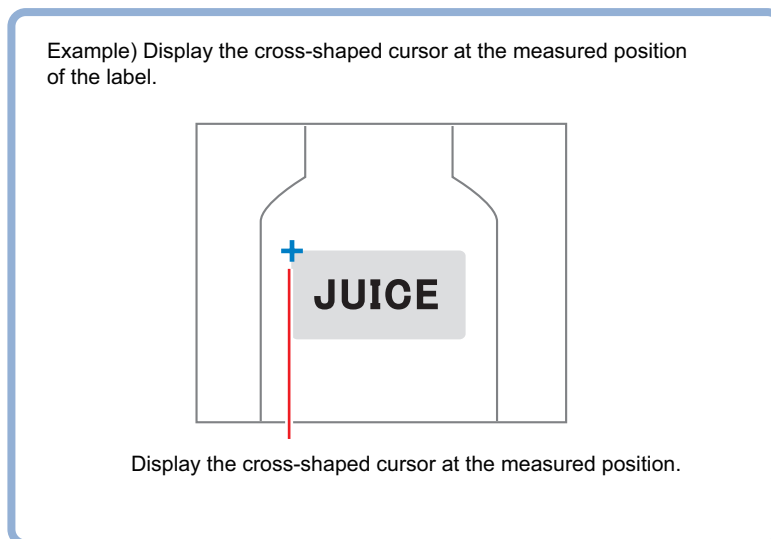
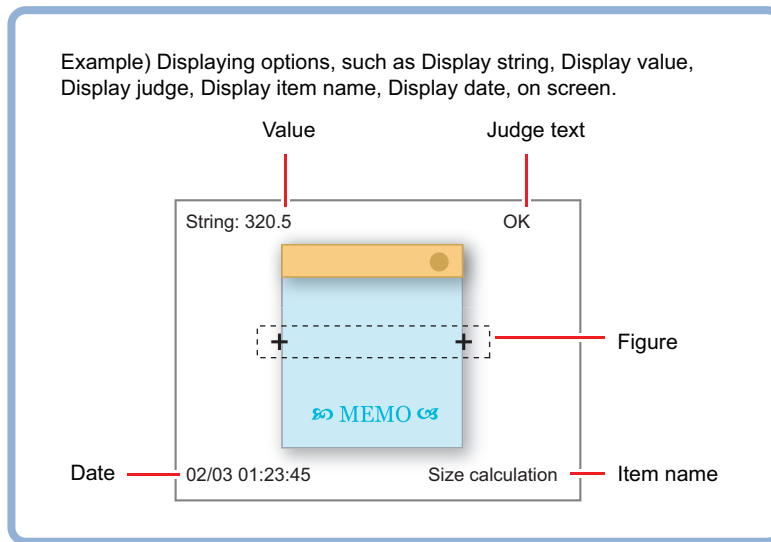

7-1-1 Result Display

- 1 In the *List of result display* area, select the number with which to set the object and click **Add**.

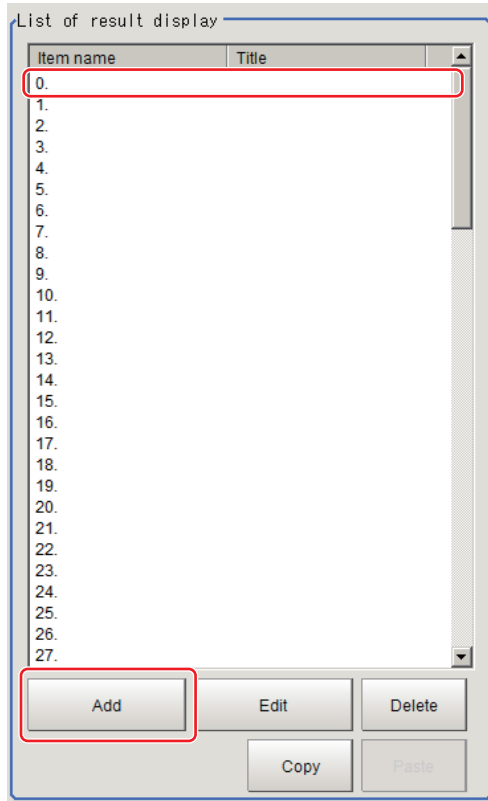

- 2 Select the object to be added in the *Select Items to Display* window and click **OK**. The selected object is added to the *List of result display* area and the Image Display area.
- 3 In the *List of result display* area, select the object and click **Edit**. Setting options are displayed. The setting items are different depending on the object.

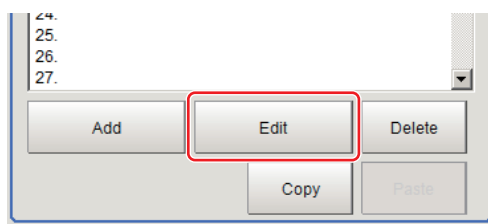

- 4 Click **Change title** as necessary to change titles displayed in the list of result display. Up to 31 characters can be entered.

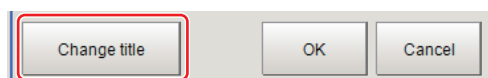

When Display Rectangle, Line, Circle, Ellipse, Arc, Cursor Display, or Display Cross Line Is Selected

Specify display position, style, width, and color of figure.

Setting item	Setting item	Description
Display position Disp pos	Figure (or Numerical)	Select this if you would like the figure to always display in the same location. Methods for specifying display position include drawing the figure on the window and indicating coordinates numerically. If you would like to always display the figure in a reference position, set up an expression using Operation .
	Operation	Select this when you would like to change display position for each measurement based on the measured value. Set up the expression to specify the display position.
Style	<ul style="list-style-type: none"> • Solid line • Dashed line 	Select the line type.
Width	1 to 10	Select the line width.
Color	OK Color	Displayed in green.
	NG Color	Displayed in red.
	Judgment	Displayed using OK color or NG color based on the judgment results. Specify measurement values subject to judgment and set up respective judgment conditions.
	Arbitrary color	Displayed using specified color. Methods for specifying color include specifying by clicking on a color chart and specifying RGB values.

When Display String, Value, Item name, Judge, Date, or Display Unit string Is Selected

Sets display position, size, and color etc. of characters.

- Common settings:

Setting item	Setting value	Description
Display position Disp pos	Figure (or Numerical)	Select this if you would like the figure to always display in the same location. Methods include specifying by clicking on the window and specifying coordinate values. If you would like to always display the figure in a reference position, set up an expression using Operation .
	Operation	Select this when you would like to change display position for each measurement based on the measured value. Set up the expression to specify the display position.

- Detail:

Setting item	Setting value	Description
Align	<ul style="list-style-type: none"> • Top • bottom • Left • Center • Right 	Specify the alignment of the text.
Size	10 to 200	Specify the font size.
Angle	0 to 359	Specify the display angle.
Style	<ul style="list-style-type: none"> • Bold • Italic • Under line • Mark out 	Specify the character decoration.
Character color	OK Color	Displayed in green.
	NG Color	Displayed in red.
	Judgment	Displayed using OK color or NG color based on the judgment results. Specify measurement values subject to judgment and set up respective judgment conditions.
	Arbitrary color	Displayed using specified color. Methods for specifying color include specifying by clicking on a color chart and specifying RGB values.

- Display string:

Setting item	Setting value	Description
Set letter	-	Set characters within 64 characters. For details, refer to <i>Inputting Text</i> in the <i>Vision Sensor FH/FHV Series Vision System User's manual (Cat. No. Z365)</i> .

- Display judge:

Setting item	Setting value	Setting value
Judge type	-	Specify measurement values subject to judgment and set up respective judgment conditions. Displays using OK letter or NG letter based on the judgment results.
Judgment condition	-999,999,999.9999 to 999,999,999.9999	
OK letter	-	Sets characters displayed for the case that judgment results are OK.
NG letter	-	Sets characters displayed for the case that judgment results are NG.

- Display date:

Setting item	Setting value	Description
Date kind	<ul style="list-style-type: none"> • Month/Day/Hour/Minute/Second • Month/Day/Hour/Minute • Hour/Minute/Second • Hour/Minute 	Select display format. Adjust the calendar time that comes with the controller in advance. For details, refer to <i>Setting Date/Time [Date/Time Settings]</i> in the <i>Vision Sensor FH/FHV Series Vision System User's manual (Cat. No. Z365)</i> .

- Display value:

Setting item	Setting value	Description
Measurement	—	Specify the measurements you would like to display using expression.
Digits of integer	1 to 10	Specify the digits of the integer including the sign. For positive number, the plus sign "+" is not output. Example: Setting: 4 digits, data - 5619 The output is -999.
Decimal	0 to 4	Set the number of fraction digits. Decimals are rounded off to output. When 0 is set, the decimal digits will be rounded off.

- Display processing item name:

Setting item	Setting value	Description
Processing item	-	Select the processing name in the displayed scene.

- Display cross line:

Setting item	Setting value [Factory default]	Description
Scale display	-	Place a check to show the scale.
Unit	<ul style="list-style-type: none"> • [Calibration] • Pixels 	Select the unit used when grids are displayed.
Interval	0.0000 to 9,999.9999 [50.0000]	Set the intervals of the scale on the grids.
Line length	0.0000 to 9,999.9999 [10.0000]	Set the length of the scale line on the grids.

- Display unit string:

Setting item	Setting value [Factory default]	Description
Processing item name	[<None>]	Select the processing item name in the displayed scene. Processing items for Barcode, 2D code, and Character inspection can be selected.
Set unit string	[<None>]	Select a character string contained in the selected processing item name. <ul style="list-style-type: none"> • Character inspection: Reading string, verification string • Barcode: Reading string, comparison string, and error output character string • 2D code: Reading string, comparison string, and error output character string
String range specify	<ul style="list-style-type: none"> • Checked [1] to [3,200] • [Unchecked] 	Place a check to set the display range of character string.

When Display unit graphic is Selected

Specify unit number and image number.

- Display unit graphic:

Setting item	Setting value [Factory default]	Description
Processing item	0 to 9,999 [0]	Select the processing item name in the displayed scene.
Sub number	-1 to 99 [0]	Select the sub image number to be displayed for the selected processing item.

7-1-1 Toggling Between Show and Hide by Judgment

Show and hide can be toggled by judgment.

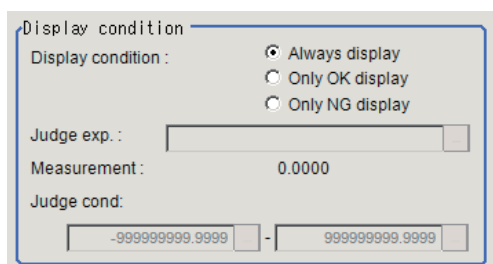

Setting item	Setting value [Factory default]	Description
Display condition	<ul style="list-style-type: none"> • [Always display] • Only OK display • Only NG display 	Place a check to show the scale.
Judge exp.	-	Set an expression to determine whether it is OK or NG.
Judge cond	-99999999.99999 to 99999999.99999	Specify the range where the measurement result is judged to be OK.

7-1-2 External Reference Tables (Result Display)

No.	Data name	Data ident	Set/Get	Data range
None	Figure Set	fig_00	Set/Get	Figure Set
:	:	:	:	:
None	Figure Set	fig_99	Set/Get	Figure Set
0	Judge	judge	Get only	0: No judgment (unmeasured), 1: Judgment result OK, -1: Judgment result NG, -10: Error (image format mismatch), -11: Error (unregistered model), -12: Error (insufficient memory), -20: Error (other errors)
1,100	Title	title_00	Set/Get	Character string
1,101	Display position	type_00	Set/Get	0: Figure (Numerical), 1: Operation, 2: Camera middle
1,102	L-Up X	calcstr0Box_00	Set/Get	Exp. character string
1,103	L-Up Y	calcstr1Box_00	Set/Get	Exp. character string
1,104	R-Down X	calcstr2Box_00	Set/Get	Exp. character string

No.	Data name	Data ident	Set/Get	Data range
1,105	R-Down Y	calcstr3Box_00	Set/Get	Exp. character string
1,106	Init X	calcstr0Line_00	Set/Get	Exp. character string
1,107	Init Y	calcstr1Line_00	Set/Get	Exp. character string
1,108	Terminal X	calcstr2Line_00	Set/Get	Exp. character string
1,109	Terminal Y	calcstr3Line_00	Set/Get	Exp. character string
1,110	Width (Line)	calcstr4Line_00	Set/Get	Exp. character string
1,111	Central X (Expression)	calcstr0Circle_00	Set/Get	Exp. character string
1,112	Central Y (Expression)	calcstr1Circle_00	Set/Get	Exp. character string
1,113	Radius	calcstr2Circle_00	Set/Get	Exp. character string
1,114	Width (Circumference)	calcstr3Circle_00	Set/Get	Exp. character string
1,115	Radius X	calcstr2Ellipse_00	Set/Get	Exp. character string
1,116	Radius Y	calcstr3Ellipse_00	Set/Get	Exp. character string
1,117	Width (Arc)	calcstr3Arc_00	Set/Get	Exp. character string
1,118	Start angle	calcstr4Arc_00	Set/Get	Exp. character string
1,119	End angle	calcstr5Arc_00	Set/Get	Exp. character string
1,120	Disp pos X (Expression)	calcPositionX_00	Set/Get	Exp. character string
1,121	Disp pos Y (Expression)	calcPositionY_00	Set/Get	Exp. character string
1,122	Disp pos X	positionX_00	Set/Get	0 to 99,999
1,123	Disp pos Y	positionY_00	Set/Get	0 to 99,999
1,124	Central X	positionXMid_00	Set/Get	0 to 99,999
1,125	Central Y	positionYMid_00	Set/Get	0 to 99,999
1,126	Style	style_00	Set/Get	0: Solid (display arc), 0: Solid 1: Dot (display rectangle/ display line/display circle/ display ellipse/display cursor/ display cross line)
1,127	Width	width_00	Set/Get	1 to 2 (display arc), 1 to 10 (display rectangle/display line/display circle/display el- lipse/display cursor/display cross line)
1,128	Color	colorKind_00	Set/Get	0: OK Color, 1: NG Color, 2: Specify judgment condition, 3 :Arbitrary color
1,129	Color R	colorR_00	Set/Get	0 to 255
1,130	Color G	colorG_00	Set/Get	0 to 255
1,131	Color B	colorB_00	Set/Get	0 to 255
1,132	Color Specify judgement condition	colorStr_00	Set/Get	Exp. character string
1,133	Color Upper limit of judgement	colorUpp_00	Set/Get	-999,999,999.9999 to 999,999,999.9999
1,134	Color Lower limit of judgement	colorLow_00	Set/Get	-999,999,999.9999 to 999,999,999.9999

No.	Data name	Data ident	Set/Get	Data range
1,135	Alignment	align_00	Set/Get	0: Top Left, 1: Top Center 2: Top Right, 3: Bottom Left, 4: Bottom Center, 5: Bottom Right
1,136	Bold	bold_00	Set/Get	0: OFF, 1: ON
1,137	Italic	italic_00	Set/Get	0: OFF, 1: ON
1,138	Underline	underline_00	Set/Get	0: OFF, 1: ON
1,139	Denied line	strikeout_00	Set/Get	0: OFF, 1: ON
1,140	Size	size_00	Set/Get	10 to 200
1,141	Angle	angle_00	Set/Get	0 to 359
1,142	Set letter	setString_00	Set/Get	Character string
1,143	Measurement	calcValue_00	Set/Get	Exp. character string
1,144	Integer	integerDigit_00	Set/Get	1 to 10
1,145	Decimal	decimalDigit_00	Set/Get	0 to 4
1,146	Item	unitNo_00	Set/Get	0 to 9,999: Unit No. (item name display), -1 to 9,999: Unit No. (display unit graphic/display unit string)
1,147	OK letter	stringOK_00	Set/Get	Character string
1,148	NG letter	stringNG_00	Set/Get	Character string
1,149	Judge type (Display judge)	calcJudge_00	Set/Get	Exp. character string
1,150	Upper limit of judgement (Display judge)	judgeUpp_00	Set/Get	-999,999,999.9999 to 999,999,999.9999
1,151	Lower limit of judgement (Display judge)	judgeLow_00	Set/Get	-999,999,999.9999 to 999,999,999.9999
1,152	Date kind	typeDate_00	Set/Get	0: Month/Day/Hour/Minute/Second, 1: Month/Day/Hour/Minute, 2: Hour/Minute/Second, 3: Hour/Minute,
1,153	Scale	dispScale_00	Set/Get	0: OFF, 1: ON
1,154	Interval	scaleInterval_00	Set/Get	0.0000 to 9,999.9999
1,155	Length	scaleLength_00	Set/Get	0.0000 to 9,999.9999
1,156	Unit	scaleUnit_00	Set/Get	0: Calibration parameter, 1: Pixel
1,157	String range specify	strRange_00	Set/Get	0: OFF, 1: ON
1,158	Lower limit of string range specify	strlenLow_00	Set/Get	1 to 3,200
1,159	Upper limit of string range specify	strlenUpper_00	Set/Get	1 to 3,200
1,160	Set unit string	stringIdent_00	Set/Get	0 to 100
1,161	Image	subNo_00	Set/Get	-1 to 99
1,162	Condition display	dispType_00	Set/Get	0: Always display, 1: Only OK display, 2: Only NG display
1,163	Judge type	judgeDispStr_00	Set/Get	Exp. character string
1,164	Upper limit of judgement	judgeDispUpp_00	Set/Get	-999,999,999.9999 to 999,999,999.9999
1,165	Lower limit of judgement	judgeDispLow_00	Set/Get	-999,999,999.9999 to 999,999,999.9999

No.	Data name	Data ident	Set/Get	Data range
1,166	Select items to display	assign_00	Set/Get	0: Display rectangle, 1: Display line, 2: Display circle, 3: Display ellipse, 4: Display arc, 5: Display cursor, 6: Display string, 7: Display value, 8: Display item name, 9: Display judge, 10: Display date, 11: Display cross line, 12: Display unit string, 13: Display unit graphic
2,100	Title	title_01	Set/Get	Character string
:	:	:	:	:
3,100	Title	title_02	Set/Get	Character string
:	:	:	:	:
:	:	:	:	:
100,100	Title	title_99	Set/Get	Character string
100,166	Select items to display	assign_99	Set/Get	0: Display rectangle, 1: Display line, 2: Display circle, 3: Display ellipse, 4: Display arc, 5: Display cursor, 6: Display string, 7: Display value, 8: Display item name, 9: Display judge, 10: Display date, 11: Display cross line, 12: Display unit string, 13: Display unit graphic

7-2 Display Image File

This processing item is not available in the FHV series.

Displays image files in the external memory device such as a USB flash drive or RAMDisk.

Used in the Following Case

Use when you want to display camera input images to be used as reference or work images that are OK or NG (Judgment is Passed or Failed).

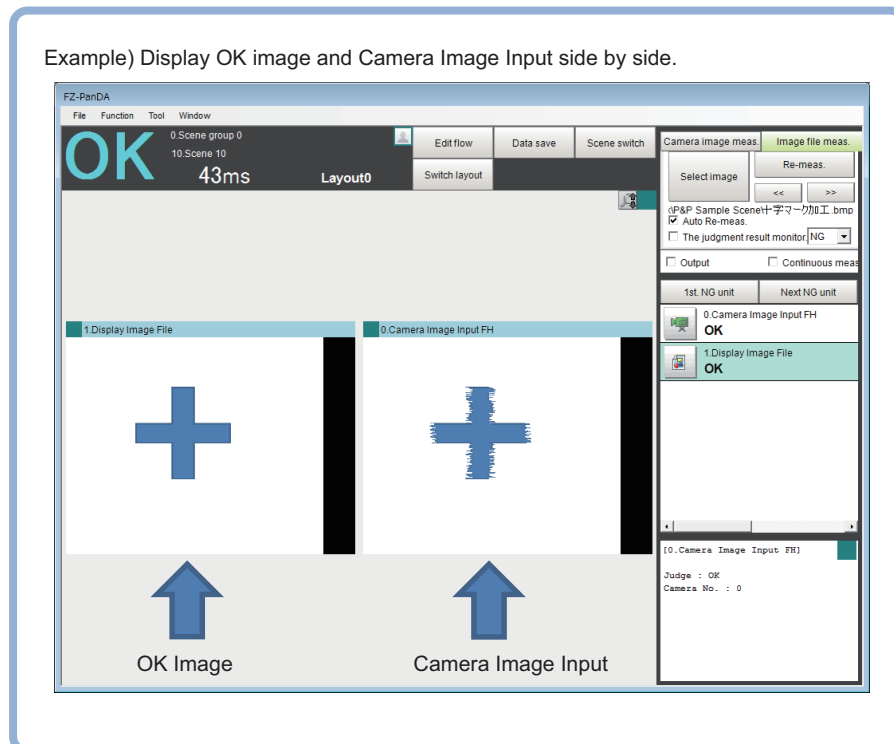

7-2-1 Select Image (Display Image File)

- 1 Set the number of image files to register.
Up to 4 images can be selected by entering **Number of image**.

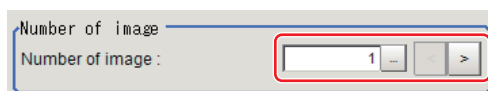

- 2 Specify image to display.
Set **System settings - Logging setting - Multiple image logging** to **ON**. When there are multiple images in an image file, set an image, enter the **Capture No.** * and **Camera No.** to set an image.

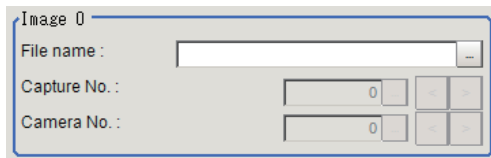

Enter the number of Camera input image to **Captuer No.**.

For details, refer to *Appendices Image file* in the *Vision Sensor FH/FHV Series Vision System User's manual (Cat. No. Z365)*.



Precautions for Correct Use

Only image logging files (ifz format) and BMP format image files for which the region size is 1,600 x 1,200 or less can be specified.

3

Select an image to display on the *Properties* dialog box.

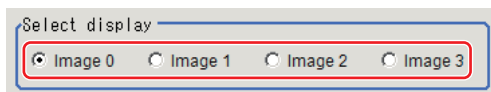

Precautions for Correct Use

The images in image file 0 to 3 can be displayed by specifying the sub-image number on the RUN window and ADJUST window.

For details, refer to *Setting Windows* in the *Vision System FH/FHV Series User's manual (Cat. No. Z365)*.

4

Click **OK**.

The settings are completed.

7-2-2 Key Points for Test Measurement and Adjustment (Display Image File)

The following content can be confirmed in the *Detail result* area using text.

Display item	Description
Judge	Judget result

The image specified by the sub-image number in the image display setting is displayed in the *Image display* area.

Sub-image No.	Description of image to be displayed
0	Image 0
1	Image 1
2	Image 2
3	Image 3

7-2-3 External Reference Tables (Display Image File)

No.	Data name	Data ident	Set/Get	Data range
120	Number of files	fileNum	Set/Get	1 to 4
121	Camera No.0	cameraNo0	Set/Get	0 to 15
122	Camera No.1	cameraNo1	Set/Get	0 to 15

No.	Data name	Data ident	Set/Get	Data range
123	Camera No.2	cameraNo2	Set/Get	0 to 15
124	Camera No.3	cameraNo3	Set/Get	0 to 15
125	File name 0	file0	Set/Get	Character string
126	File name 1	file1	Set/Get	Character string
127	File name 2	file2	Set/Get	Character string
128	File name 3	file3	Set/Get	Character string
129	Capture No.0	captureNo0	Set/Get	0 to 9,999 (Maximum depending on image file)
130	Capture No.1	captureNo1	Set/Get	0 to 9,999 (Maximum depending on image file)
131	Capture No.2	captureNo2	Set/Get	0 to 9,999 (Maximum depending on image file)
132	Capture No.3	captureNo3	Set/Get	0 to 9,999 (Maximum depending on image file)

7-3 Display Last NG Image

Using NG conditions defined by an expression allows you to store the maximum four measurement images for the specified processing unit or specified data by arithmetic expression. Since the stored images or data are remained even if you operate the window. Since the stored images or data are stored on the memory, so they are held even if you operate the window.

Used in the Following Case

Image and data for NG case are held:

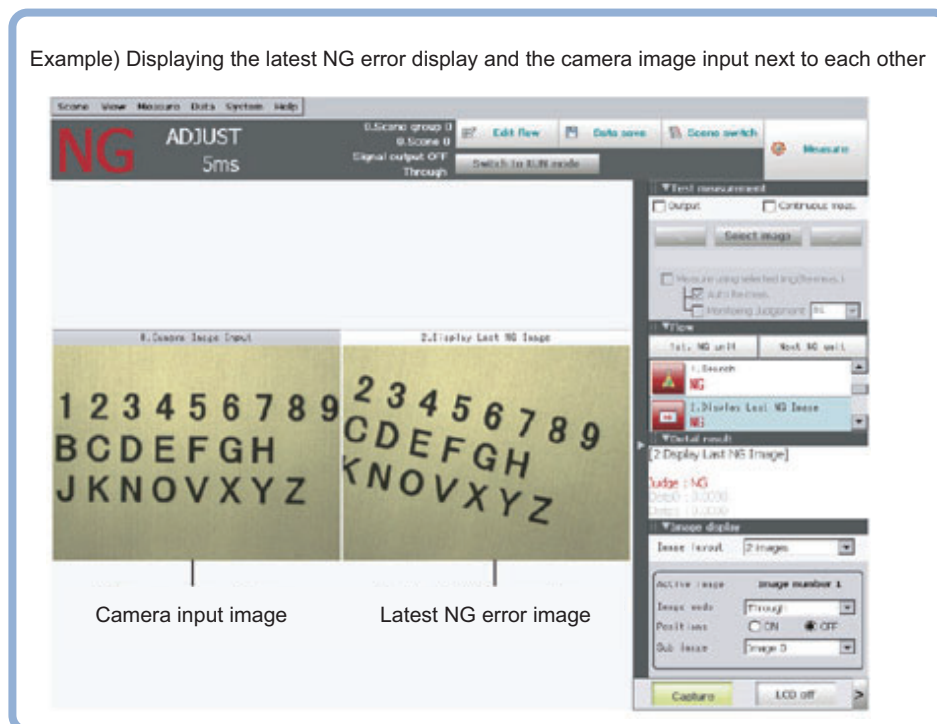

7-3-1 NG Error Judgment (Display Last NG Image)

Sets conditions for NG judgment.

- 1 Click **Judge NG** in the Item tab area.
- 2 Set the **out** in the *NG settings* area.

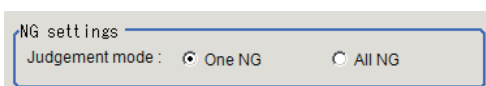



Setting item	Setting value [Factory default]	Description
Judgment mode	<ul style="list-style-type: none"> [One NG] All NG 	<ul style="list-style-type: none"> One NG: The image is saved even if only one of the judgment items set by the <i>Judgment expression</i> is judged as NG. All NG: The image is saved if all the judgments set by the <i>judgment expression</i> are judged as NG.

Expression Settings

The measurement details used for NG judgment are set up using an expression.

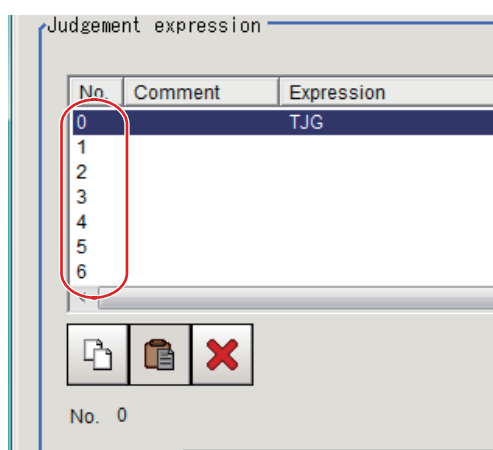
- 1 Click **No.** to set the expression on the list in the *Judgment expression* area.
The selected No. will be displayed below the list.



- 2 Click  for the expression to set the expression.
An expression setting window is displayed.
- 3 Click **OK**.
The expression is set.
- 4 Click  for the **comment** to enter an explanation for the expression as necessary.
Multilingual is also supported.
For details, refer to *Inputting Text* in the *Vision Sensor FH/FHV Series Vision System User's manual (Cat. No. Z365)*.
- 5 Set the upper and lower limits for the Judgment in the **Judgment condition**.

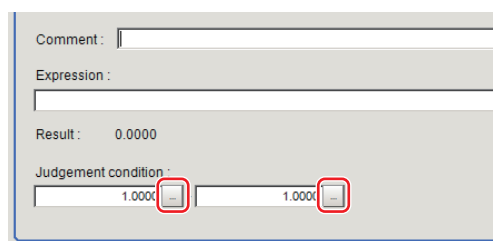

Setting item	Setting value	Description
Judgment condition	-999,999,999.9999 to 999,999,999.9999	This judgment condition is for the expression. Set the upper and lower limits to judge OK.

- 6** Repeat the step 1 to 5 to set the expression.

7-3-2 Image Saving (Display Last NG Image)

Specifies the target unit to be saved and the number of times to save images when an NG occurs.

- 1 Click **Image save** in the Item tab area.
- 2 Set each item.

Setting item	Setting value [Factory default]	Description
No. of logging	1 to 4 [1]	Sets the number of NG images to save. A maximum of four NG images consisting of Last NG, Last 1 NG, Last 2 NG, Last 3 NG can be saved.
Unit	-	Specifies the target processing unit to save an image. Select the unit (Camera Input Image, image with pre-processing or position compensation) with the image to save. Select a target unit placed prior to this processing unit in the flow.
Set an image for next unit.	<ul style="list-style-type: none"> • Checked • [Unchecked] 	Place a check when a subsequent processing unit uses captured images.

- 3** Set the expression



Additional Information

The saved images are held in the sub-image number 0 to 3.
(0: Last NG, 1: Last 1 NG, 2: Last 2 NG, 3: Last 3 NG)

To display the sub-image number, refer to Setting Windows in the *Vision Sensor FH/FHV Series Vision System User's Manual (Cat. No. Z365)*.

7-3-3 Data Saving (Display Last NG Image)

Sets data to be saved when an NG occurs.

- 1 Click **Saving data** in the Item tab area.
- 2 Set each item.

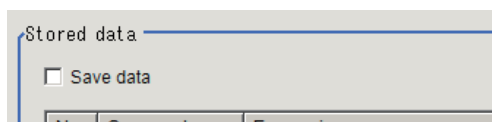

Setting item	Setting value [Factory default]	Description
Save data	<ul style="list-style-type: none"> • Checked • [Unchecked] 	Place a check when saving measurement data set by an expression when an NG occurs. In conjunction with the number of saves, the maximum four measurement data from Last NG, Last 1 NG, Last 2 NG and Last 3 NG can be saved for one expression. Set the expression to refer to a unit prior to the current one.

- 3 Set the expression.
- 4 Set the *Judgement condition*.



Additional Information

For the saved data, refer to 7-3-6 *Measurement Results for Which Output Is Possible (Display Last NG Image)* on page 7-18.

7-3-4 Output parameters (Display Last NG Image)

Specifies whether or not the judgment results of this processing unit is reflected in the scene overall judgment.

- 1 Click **Output parameter** in the Item tab area.
- 2 Specify whether or not to reflect the judgment result in the scene overall judgment in *Reflect to overall judgment* area.

Setting item	Setting value [Factory default]	Description
Reflect to overall judgment	<ul style="list-style-type: none"> • [ON] • OFF 	Enables choosing whether or not the judgement results of this processing unit is reflected in the scene overall judgment.

7-3-5 Key Points for Test Measurement and Adjustment (Display Last NG Image)

The following content is displayed in the *Detail result* area as text.

Displayed item	Description
Comment of Data 0	Expression result of Expression 0
Comment of Data 1	Expression result of Expression 1
Comment of Data 2	Expression result of Expression 2
Comment of Data 3	Expression result of Expression 3
Comment of Data 4	Expression result of Expression 4
Comment of Data 5	Expression result of Expression 5

Displayed item	Description
Comment of Data 6	Expression result of Expression 6
Comment of Data 7	Expression result of Expression 7
Comment of Data 8	Expression result of Expression 8
Comment of Data 9	Expression result of Expression 9
Comment of Data 10	Expression result of Expression 10
Comment of Data 11	Expression result of Expression 11
Comment of Data 12	Expression result of Expression 12
Comment of Data 13	Expression result of Expression 13
Comment of Data 14	Expression result of Expression 14
Comment of Data 15	Expression result of Expression 15

The image specified in the Sub-image number in the image display setting is displayed in the *Image Display* area.

Sub-image number	Description of image to be displayed
0	Last NG image
1	Previous NG error image (Displayed when there are 2 or more saved images. Otherwise, "Last NG" image is displayed.)
2	NG error image from 2 previous (Displayed when there are 3 or more saved images. Otherwise, "Last NG" image is displayed.)
3	NG error image from 3 previous (Displayed when there are 4 or more saved images. Otherwise, "Last NG" image is displayed.)

7-3-6 Measurement Results for Which Output Is Possible (Display Last NG Image)

The following values can be output using processing items related to result output. It is also possible to reference measurement values from calculation expressions and other processing units.

Measurement items	Character string	Description
Judge	JG	Judgment results 0: No judgment (unmeasured) 1: Judgment result OK -1: Judgment result NG -10: Error (image format mismatch) -11: Error (unregistered model) -12: Error (insufficient memory) -20: Error (other errors)
Condition data 00 to 07	JD 00 to 07	Calculation data 00 to 07 for inclusion 0
Condition judgment 00 to 07	JJ 00 to 07	Calculation judgment 00 to 07 for inclusion
Last NG data 00 to 15	D0 00 to 15	NG data 00 to 15
Last NG judgment 00 to 15	J0 00 to 15	NG judgment 00 to 15
Last 1 NG data 00 to 15	D1 00 to 15	Last 1 NG data 00 to 15
Last 1 NG judgment 00 to 15	J1 00 to 15	Last 1 NG judgment 00 to 15
Last 2 NG data 00 to 15	D2 00 to 15	Last 2 NG data 00 to 15
Last 2 NG judgment 00 to 15	J2 00 to 15	Last 2 NG judgment 00 to 15
Last 3 NG data 00 to 15	D3 00 to 15	Last 3 NG data 00 to 15
Last 3 NG judgment 00 to 15	J3 00 to 15	Last 3 NG judgment 00 to 15

7-3-7 External Reference Tables (Display Last NG Image)

No.	Data name	Data ident	Set/Get	Data range
0	Judge	judge	Get only	0: No judgment (unmeasured), 1: Judgment result OK, -1: Judgment result NG, -10: Error (image format mismatch), -11: Error (unregistered model), -12: Error (insufficient memory), -20: Error (other errors)
5+N (N=0 to 7)	Judge data	judgeData0 to judgeData7	Set/Get	-999,999,999.9999 to 999,999,999.9999
13+N (N=0 to 7)	Judge judge	judgeJudge0 to judgeJudge7	Set/Get	0: No judgment (unmeasured), 1: Judgment result OK, -1: Judgment result NG
103	Reflect to overall judgement	overallJudge	Set/Get	0: ON, 1: OFF
120	Judgement mode	judgeMode	Set/Get	0: One NG, 1: All NG
121	Save type	saveType	Set/Get	0: Image, 1: Image + data
122	Number of loggings :	saveCount	Set/Get	1 to 4
123	Target processing unit number	unitNo	Set/Get	-1 to 9,999, -1: Images in own processing unit saved
124	Image memory setting flag	setImageFlag	Set/Get	0: OFF, 1: ON
140+N (N=0 to 7)	Condition exp	judgeStr0 to judgeStr7	Set/Get	Exp character string for inclusion processing unit 0
148+N×2 (N=0 to 7)	Upper limit of condition calculation	upperJudge0 to upperJudge7	Set/Get	-999,999,999.9999 to 999,999,999.9999
149+N×2 (N=0 to 7)	Lower limit of condition calculation	lowerJudge0 to lowerJudge7	Set/Get	-999,999,999.9999 to 999,999,999.9999
164+N (N=0 to 7)	Condition calculation Comment	commentJudge0 to commentJudge7	Set/Get	Character string
180+N (N=0 to 15)	Data exp	setupData00 to setupData15	Set/Get	Exp character string.
196+N×2 (N=0 to 15)	Upper limit for data calculation	upperCalc00 to upperCalc15	Set/Get	-999,999,999.9999 to 999,999,999.9999
197+N×2 (N=0 to 15)	Lower limit for data calculation	lowerCalc00 to lowerCalc15	Set/Get	-999,999,999.9999 to 999,999,999.9999
228+N (N=0 to 15)	Data calculation comment	comment00 to comment15	Set/Get	Character string
244+N (N=0 to 15)	Comment view	commentView00 to commentView15	Set/Get	0: OFF, 1: ON
500+N (N=0 to 15)	Latest NG image data	resultData00 to resultData15	Get only	-999,999,999.9999 to 999,999,999.9999
532+N (N=0 to 15)	1 time before NG image data	D100 to D115	Get only	-999,999,999.9999 to 999,999,999.9999
564+N (N=0 to 15)	2 times before NG image data	D200 to D215	Get only	-999,999,999.9999 to 999,999,999.9999
596+N (N=0 to 15)	3 times before NG image data	D300 to D315	Get only	-999,999,999.9999 to 999,999,999.9999

7-4 Conveyor Panorama Display

Conveyor Panorama Display is a processing item exclusively for the FH Sensor Controller and is specifically used for the conveyor tracking application.

Conveyor Panorama Display cannot be operated on the FH Sensor Controller. Use Sysmac Studio.

For more information, refer to the *Vision Sensor FH Series Conveyor Tracking Application Programming Guide (Cat. No. Z368)*.

Used in the Following Case

Use Conveyor Panorama Display when you want to show images of the tracking area as a panoramic image to help in the adjusting of the conveyor speed and trigger interval:

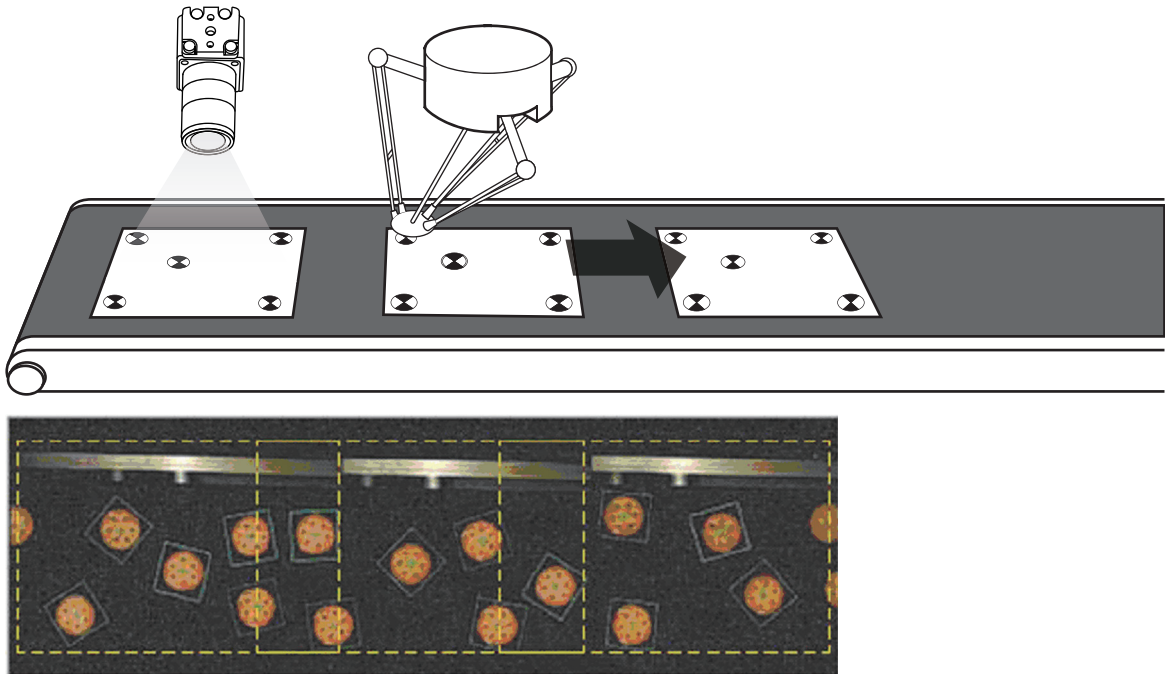

7-5 Display Image Hold

Processing item to retain images including measurement results.

This processing item captures the image window for an Image Input processing item processed immediately before as the set state of the position list display.

Used in the Following Cases

- When measurement results are deleted having not passed through a branching, and are displayed as not measured:
- After scene switching, when measurement results are deleted and are displayed as not measured:



Precautions for Correct Use

- This processing item captures the image window as the position list display. Accordingly, if zoomed then character strings will be enlarged, and graphics diagrams displayed with thicker lines.
- Additionally, previous processing type processing item settings up until image input type processing items immediately before are not reflected.

7-5-1 Display Image Retention Settings (Display Image Hold)

This processing item is set by situating in a scene. There are no items to set.

This processing item captures the image window for the image input type processing items processed immediately before the situated flow, as the set position list display status.

Retained images are retained even after scene switching. Delete retained images by switching the scene group, turning the power OFF, or from **Function** in the menu, executing **Clear Measurement Results**.



Additional Information

When editing a processing unit with the TDM editor, you can specify the Unit number and Sub-image number to be displayed.

For details, refer to *Setting the Editing Processing Units in a Scene [TDM Editor]* in the *Vision System FH/FHV Series User's manual (Cat. No. Z365)*.

Setting item	Setting value [Factory default]	Description
Unit number to be displayed	-1: No setting 0 to 9,999: Unit No. [-1]	Specify the number of the unit whose image will be referenced. If nothing is set, the image from the preceding processing unit will be displayed.
Sub-image number to be displayed	-1: No setting 0 to 99: Sub image number [-1]	Specify a sub image number for the measurement image to display. The sub image number that can be displayed depends on the processing item. If nothing is set, all positions will be displayed.

7-5-2 External Reference Tables (Display image hold)

No.	Data name	Data ident	Set/Get	Data range
None	Judge	judge	Get only	0: No judgment (unmeasured), 1: Judgment result OK, -1: Judgment result NG, -10: Error (image format mismatch), -11: Error (unregistered model), -12: Error (insufficient memory), -20: Error (other errors)
None	Sub-image number to be displayed	subNo	Set/Get	Sub-number possessed by processing item to be displayed
None	Unit number to be displayed	displayUnitNo	Set/Get	



Index

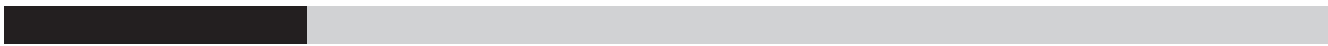

Index

Numerics

2D Code.....	2-429
2D Code II.....	2-456

A

Advanced Filter.....	3-73
AI Fine Matching.....	2-575
Anti Color Shading.....	3-35
Ave. pitch.....	2-197
Ave. width.....	2-197

B

Background Suppression.....	3-14
Barcode.....	2-477
Brightness Correct Filter.....	3-19

C

Calc Axis Move.....	4-197
Calc Axis Move by Multipoint.....	4-212
Calculation.....	4-8
Calibration Data Reference.....	4-122
Camera Calibration.....	4-249
Camera Image Input.....	1-3
Camera Image Input FH.....	1-28
Camera Image Input FHV.....	1-66
Camera Image Input HDR (using FH Controller).....	1-93
Camera Image Input HDR (using FHV Controller).....	1-105
Camera Image Input HDR Lite.....	1-116
Camera Switching.....	1-167
Character Inspection.....	2-395
check No. range.....	2-242
Check No. range.....	2-257
Circle Angle.....	2-546
Circle Regression.....	4-28
Circular Scan Edge Position.....	2-233
Circular Scan Edge Width.....	2-250
Classification.....	2-166
Color Data.....	2-282
Color Gray Filter.....	3-24
Color to count.....	2-196
Compati. (Ver.5.73 or earlier).....	2-211, 2-271
Conditional Branch.....	5-3
Conditional Execution (Else).....	5-50
Conditional Execution (If).....	5-45
Control Flow Fieldbus.....	5-32
Control Flow Normal.....	5-16
Control Flow Parallel.....	5-27
Control Flow PLC Link.....	5-21
Conveyor Calibration.....	4-293
Conveyor Panorama Display.....	7-20

D

Data Logging.....	4-91
Data Output.....	6-7
Data Save.....	4-265
Date Verification.....	2-408
Defect.....	2-348
Density change.....	2-186, 2-210, 2-226, 2-240, 2-256, 2-270
Derivation.....	2-255
Detection Point.....	4-228
DI Branch.....	5-11
Display Image File.....	7-11
Display Image Hold.....	7-21
Display Last NG Image.....	7-14
Distance.....	2-211, 2-271

E

EC Circle Search.....	2-84
Ec Corner.....	2-138
Ec Cross.....	2-152
ECM Search.....	2-67
Edge color level.....	2-185, 2-195, 2-209, 2-225, 2-240, 2-255, 2-269
Edge level.....	2-195, 2-196
Edge Lower.....	2-185, 2-186, 2-209, 2-210, 2-225, 2-226, 2-240, 2-255, 2-256, 2-269, 2-270
Edge No.....	2-185, 2-186, 2-209, 2-210, 2-225, 2-226, 2-240, 2-255, 2-256, 2-269, 2-270
Edge Pitch.....	2-192
Edge Position.....	2-178
Edge position X.....	2-187
Edge position Y.....	2-187
Edges.....	2-197
Edge Upper.....	2-185, 2-186, 2-209, 2-210, 2-225, 2-226, 2-240, 2-255, 2-256, 2-269, 2-270
Elapsed Time.....	4-98
Enabled.....	2-209, 2-225, 2-268
End.....	5-9
Enlarged display.....	2-197
Extract Color Filter.....	3-28

F

Fieldbus Data Output.....	6-12
Filtering.....	3-9
Filter strength.....	2-187, 2-211, 2-227, 2-241, 2-257, 2-271
Fine Matching.....	2-383
Flexible Search.....	2-39
Focus.....	4-101
Forward area.....	2-225

G

Get Unit Data.....	4-50
Get Unit Figure.....	4-60
Glue Bead Inspection.....	2-554
Gravity and Area.....	2-297

I

Image Conversion Logging.....	4-85
Image Logging.....	4-80
Image Subtraction.....	3-66
Intersection.....	2-263
Iris.....	4-106

L

Label Data.....	2-343
Labeling.....	2-317
Line Regression.....	4-22
Loop.....	5-55
Loop Interrupt.....	5-59

M

Machine Simulator.....	3-58
Manual Position Setting.....	4-231
Measurement Image Switching.....	1-169
Measure type.....	2-186, 2-210, 2-226, 2-240, 2-256, 2-270
Mode.....	2-196
Model Dictionary.....	2-421
Multi-trigger Imaging.....	1-172
Multi-trigger Imaging Task.....	1-176

N

Noise cancel.....	2-211, 2-271
Noise level.....	2-187, 2-196, 2-211, 2-227, 2-241, 2-257, 2-271
Noise width.....	2-187, 2-196, 2-211, 2-227, 2-241, 2-257, 2-271

O

OCR.....	2-498
OCR User Dictionary.....	2-492

P

Panorama.....	3-137
Parallel Data Output.....	6-9
Parallelize.....	4-112
Parallelize Task.....	4-113
Parallel Judgement Output.....	6-10
Photometric Stereo Image Input (using FH Controller).....	1-122
Photometric Stereo Image Input (using FHV Controller).....	1-144
Pitch.....	2-197
PLC Master Calibration.....	4-176
Polar Transformation.....	3-45
Position Compensation.....	3-3
Position Data Calculation.....	4-128

Precise Calibration.....	4-32
Precise Defect.....	2-364
Projection.....	2-255

R

Rate.....	2-211, 2-271
Result Display.....	7-2
Result Output (I/O).....	6-2
Result Output (Message).....	6-3
Result Output (Parallel I/O).....	6-6
Reverse area.....	2-225
Robot Data.....	4-137

S

Scan Edge Position.....	2-202
Scan Edge Width.....	2-220
Scene.....	4-294
Search.....	2-8
Search II.....	2-24
Select Execution (Case).....	5-65
Select Execution (Select).....	5-61
Selective Branch.....	5-39
Sensitive Search.....	2-50
Set Unit Data.....	4-46
Shape Search II.....	2-96
Shape Search III.....	2-111
Stage Data.....	4-268
Statistics.....	4-114
Stripes Removal Filter II.....	3-40
Sub-region No.....	2-209, 2-225, 2-239, 2-255, 2-268
System Information.....	4-302

T

Terms and Conditions.....	24
Transfer Position Data.....	4-187
Trapezoidal Correction.....	3-49
Trend Monitor.....	4-67

U

Unit Calculation Macro.....	4-7
Unit Macro.....	4-6
User Data.....	4-42

V

Vision Master Calibration.....	4-143
--------------------------------	-------

W

Wait.....	4-100
Width.....	2-197

OMRON Corporation Industrial Automation Company

Kyoto, JAPAN

Contact : www.ia.omron.com

Regional Headquarters

OMRON EUROPE B.V.

Wegalaan 67-69, 2132 JD Hoofddorp
The Netherlands
Tel: (31) 2356-81-300 Fax: (31) 2356-81-388

OMRON ASIA PACIFIC PTE. LTD.

438B Alexandra Road, #08-01/02 Alexandra
Technopark, Singapore 119968
Tel: (65) 6835-3011 Fax: (65) 6835-2711

OMRON ELECTRONICS LLC

2895 Greenspoint Parkway, Suite 200
Hoffman Estates, IL 60169 U.S.A.
Tel: (1) 847-843-7900 Fax: (1) 847-843-7787

OMRON (CHINA) CO., LTD.

Room 2211, Bank of China Tower,
200 Yin Cheng Zhong Road,
PuDong New Area, Shanghai, 200120, China
Tel: (86) 21-5037-2222 Fax: (86) 21-5037-2200

Authorized Distributor:

©OMRON Corporation 2013-2023 All Rights Reserved.
In the interest of product improvement,
specifications are subject to change without notice.

Cat. No. Z341-E1-22 0323
Printed in Japan