



Machine Automation Controller NJ-series

EtherNet/IP™ Connection Guide

OMRON Corporation Auto Focus Multi Code Reader V330-F / V430-F-series

Network
Connection
Guide

About Copyrights and Trademarks

Microsoft product screen shots used with permission from Microsoft.

Windows is a registered trademark of Microsoft Corporation in the USA and other countries.

ODVA, EtherNet/IP™ are trademarks of ODVA.

Sysmac and SYSMAC are trademarks or registered trademarks of OMRON Corporation in Japan and other countries for OMRON factory automation products.

Company names and product names in this document are the trademarks or registered trademarks of their respective companies.

Contents

1. Related Manuals	3
2. Terms and Definitions.....	4
3. Restrictions and Precautions.....	5
4. Overview	6
5. Applicable Devices and Device Configuration	7
5.1. Applicable Devices	7
5.2. Device Configuration	8
6. EtherNet/IP Settings.....	11
6.1. Parameters	11
6.2. Data Types to Use for Tag Data Links.....	12
6.3. Global Variables	14
6.4. Tag Set.....	16
6.5. Tag Data Link Table	16
7. EtherNet/IP Connection Procedure.....	17
7.1. Operation Flow	17
7.2. Code Reader Setup.....	18
7.3. Controller Setup.....	23
7.4. Checking the EtherNet/IP Communications.....	43
8. Initializing the System.....	47
8.1. Initializing the Controller	47
8.2. Initializing the Code Reader.....	47
9. Appendices How to Use the Project File	48
9.1. Operation Flow	48
9.2. Controller Setup.....	49
10. Revision History	51

1. Related Manuals

To ensure system safety, make sure to always read and follow the information provided in all Safety Precautions and Precautions for Safe Use in the manuals for each device which is used in the system.

The following OMRON Corporation (hereinafter referred to as “OMRON”) manuals are related to this document:

Cat. No.	Model	Manual name
W500	NJ Series	NJ-series CPU Unit Hardware User's Manual
W501	NJ/NX Series	NJ/NX-series CPU Unit Software User's Manual
W506	NJ/NX Series	NJ/NX-series CPU Unit Built-in EtherNet/IP Port User's Manual
W504	SYSMAC-SE2□□□	Sysmac Studio Version 1 Operation Manual
W502	NJ/NX Series	Machine Automation Controller Instructions Reference Manual
Z432	V320-F/V330-F/V420-F/V430-F Series	MicroHAWK V320-F/V330-F/V420-F/V430-F Series Barcode Reader User Manual
Z407	V320-F/V330-F/V420-F/V430-F Series	Autofocus Multicode Reader MicroHAWK V320-F/V330-F/V420-F/V430-F Series User Manual for Communication Settings

2. Terms and Definitions

Below is a list of terms used in this manual and their definitions.

Term	Description/Definition
Node	It refers to a relay point, a branch point or a terminal on an EtherNet/IP network comprised of equipment having an EtherNet/IP port. Devices with one EtherNet/IP port are recognized as one node on the EtherNet/IP network, and devices with two EtherNet/IP ports are recognized as two nodes.
Tag	A tag is a unit that is used to exchange data with tag data links. Data is exchanged between the local network variables and remote network variables specified in the tags or between specified I/O memory areas.
Tag Set	When a tag data link connection is established, one or more tags (up to eight tags including the controller status) are configured as a set. This is referred to as a Tag Set. Each tag set represents the unit of data that is linked for a tag data link connection. Tag data links are therefore created through a connection between one tag set and another tag set. A tag set name must be set for each tag set.
Tag Data Link	The Implicit communications of the EtherNet/IP standard is called a Tag Data Link. Tag data links enable cyclic tag data exchange between controllers or between a controller and other devices on an EtherNet/IP network.
Connection	A connection is used to exchange data as a unit within which data concurrency is maintained.
Connection Type	You can select multi-cast or unicast (point-to-point) as the connection type in the tag data link connection settings. Multi-cast sends an output tag set in one packet to more than one node. Unicast, on the other hand, individually sends one output tag set to each node. Therefore, using a multi-cast connection can decrease the communications load when sending one output tag to multiple nodes.
Originator and Target	To use tag data links, it is necessary to first establish a connection between the nodes that use them. The node that requests a connection is called the originator, and the node that receives the request is called the target.
Tag Data Link Parameters	In tag data link setting, “tag settings”, “tag set settings” and “connection settings” are collectively called “tag data link parameters”.
EDS File	It is a file describing device-specific information such as the number of input/output points for EtherNet/IP devices.

3. Restrictions and Precautions

- (1) Before building a system, understand the specifications of devices which are used in the system. Allow some margin for ratings and performance, and provide safety measures such as installing a safety circuit in order to minimize the risk in case of failure.
- (2) To ensure system safety, make sure to read and follow the information provided in all Safety Precautions and Precautions for Safe Use in the manuals for each device which is used in the system.
- (3) The user is encouraged to confirm the standards and regulations that the system must conform to.
- (4) It is prohibited to copy, to reproduce, and to distribute a part or the whole of this document without the permission of OMRON Corporation.
- (5) The information contained in this document is current as of February 2023. It is subject to change for improvement without notice.

The following notations are used in this document.

 WARNING	Indicates a potentially hazardous situation which, if not avoided, may result in minor or moderate injury, or may result in serious injury or death. Additionally, there may be severe property damage.
--	---

 Caution	Indicates a potentially hazardous situation which, if not avoided, may result in minor or moderate injury, or property damage.
--	--



Precautions for Correct Use

Precautions on what to do and what not to do to ensure proper operation and performance.



Note

Additional information to read as required.

This information is provided to increase understanding or make operation easier.

Symbols



The filled circle symbol indicates operations that you must do.

The specific operation is shown in the circle and explained in text.

This example shows a general precaution for something that you must do.

4. Overview

This document describes the procedures for connecting the OMRON code reader products (V330-F/V430-F Series) to an NJ Series Machine Automation Controller (hereinafter referred to as the controller) via EtherNet/IP and for checking their connections.

Refer to *Section 6. EtherNet/IP Settings* and *Section 7. EtherNet/IP Connection Procedure* to understand setting methods and key points to operate EtherNet/IP tag data links.



Note

The settings described in 7.3. *Controller Setup* are already made in advance in the Sysmac Studio project file (hereinafter referred to as “project file”) listed below. For how to use this project file, refer to 9. *Appendices How to Use the Project File*. Obtain the latest version of the project file from OMRON Corporation.

Name	Filename	Version
Sysmac Studio Compact Project File (Extension: csm2)	OMRON_V330_EIP_V100.csm2	Ver. 1.00
Sysmac Studio Compact Project File (Extension: csm2)	OMRON_V430_EIP_V101.csm2	Ver. 1.01

5. Applicable Devices and Device Configuration

5.1. Applicable Devices

The applicable devices that can be connected are as follows:

Manufacturer	Name	Model	Version
OMRON	NJ Series CPU Unit	NJ501-1500 NJ501-1400 NJ501-1300 NJ301-□□□□	Same or later version as indicated in section 5.2.
OMRON	Code reader	V330-F□□□□□□□□-□□□ V430-F□□□□□□□□-□□□	



Note

This document describes the procedures for establishing the network connections. It does not provide information on operation, installation, and wiring methods that are not directly related to the connection procedures. It also does not describe the function or operation of the equipment. Please refer to the instruction manual or contact the equipment manufacturer.



Note

From among the above applicable devices, this document uses the devices listed in section 5.2 for the connection check. When using devices that are not described in section 5.2, check the connection according to this document.



Precautions for Correct Use

The connection and connection check procedures described in this document use the devices listed in section 5.2, from among the above applicable devices.

You cannot use devices with versions earlier than the versions listed in section 5.2.

To use models that are not listed in section 5.2. or versions that are later than those listed in section 5.2., check the differences in the specifications according to their instruction manuals before operating the devices.

5.2. Device Configuration

The system components required for reproducing the connection procedures described in this document are as follows.

- Configuration with V330-F

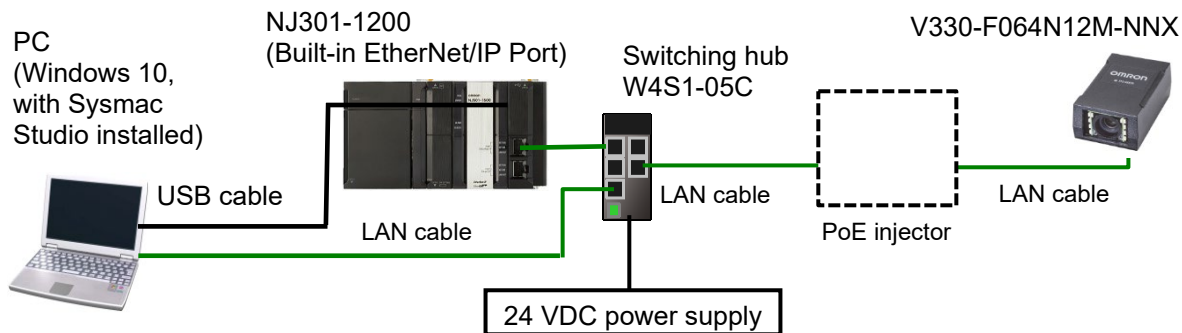

Manufacturer	Name	Model	Version
OMRON	NJ Series CPU Unit (Built-in EtherNet/IP Port)	NJ301-1200	Ver. 1.19
OMRON	Power Supply Unit	NJ-PA3001	
OMRON	Switching hub	W4S1-05C	
OMRON	Sysmac Studio	SYSMAC-SE2□□□	Ver. 1.44
OMRON	Sysmac Studio Project File	OMRON_V330_EIP_V100 .csm2	Ver. 1.00
---	PC (OS: Windows 10)	---	
---	USB cable (USB 2.0-compliant B-type connector)	---	
---	LAN cable (STP (shielded, twisted-pair) cable of Ethernet category 5 or higher)		
OMRON	Code reader	V330-F064N12M-NNX	Ver. 2.1.0
OMRON	PoE (Power over Ethernet) injector	Select one that can be powered via Ethernet.	---
---	24 VDC power supply	---	

- Configuration with V430-F

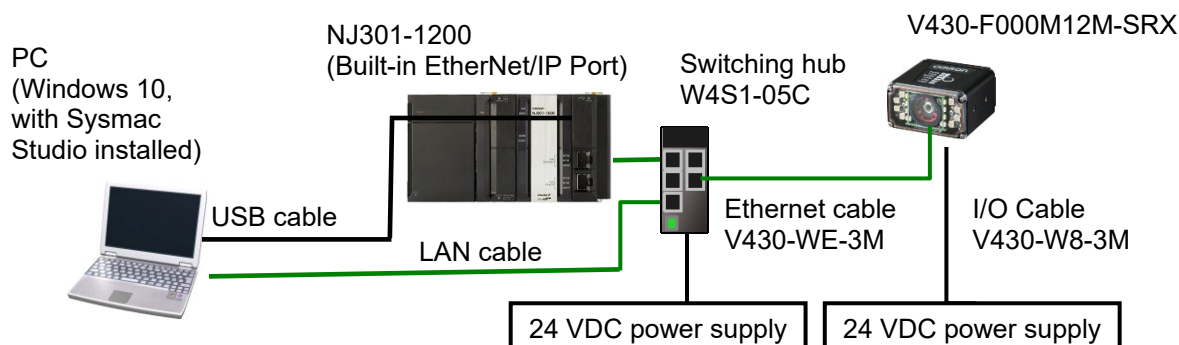

Manufacturer	Name	Model	Version
OMRON	NJ Series CPU Unit (Built-in EtherNet/IP Port)	NJ301-1200	Ver. 1.19
OMRON	Power Supply Unit	NJ-PA3001	
OMRON	Switching hub	W4S1-05C	
OMRON	Sysmac Studio	SYSMAC-SE2□□□	Ver. 1.44
OMRON	Sysmac Studio Project File	OMRON_V430_EIP_V101 .csm2	Ver. 1.00
---	PC (OS: Windows 10)	---	
---	USB cable (USB 2.0-compliant B-type connector)	---	
---	LAN cable (STP (shielded, twisted-pair) cable of Ethernet category 5 or higher)	---	
OMRON	Code reader	V430-F000M12M-SRX	Ver. 2.1.0
OMRON	I/O Cable	V430-W8-3M	
OMRON	Ethernet cable	V430-WE-3M	
---	24 VDC power supply	---	



Precautions for Correct Use

Ensure that the Sysmac Studio is updated to the version specified in this documentation, or to a higher version.

If you use a version other than the version specified in this section, there may be differences in the procedures in Section 7 and later. In that case, refer to the *Sysmac Studio Version 1 Operation Manual* (Cat. No. W504) to perform the equivalent procedures.



Note

Refer to the *Industrial Switching Hub W4S1 Series User Manual* (0969584-7) for power supply specifications that can be used for 24 VDC power supply (for the switching hub).



Note

Refer to the *MicroHAWK V320-F/V330-F/V420-F/V430-F Series Barcode Reader User Manual* (Cat. No. Z432) for the power supply specifications that can be used for 24 VDC power supply (for the code reader).



Note

This document assumes that the USB is used to connect the controller. For information on how to install the USB driver, refer to *A-1 Driver Installation for Direct USB Cable Connection* in *Appendices* of the *Sysmac Studio Version 1 Operation Manual* (Cat. No. W504).

6. EtherNet/IP Settings

This section shows the specifications of the parameters, global variables, tag sets, and tag data link table that you set in this document.

In subsequent sections, the code reader may also be referred to as “target device” depending on the description.

6.1. Parameters

The parameters that you set in this document are shown below.

6.1.1. EtherNet/IP Communication Settings

The parameters used for connecting the controller and the code reader via EtherNet/IP are as follows.

Parameter name	Controller	Code reader
Ethernet	---	Enabled
IP address	192.168.188.200	192.168.188.2
Subnet mask	255.255.0.0	255.255.0.0 (default)
Gateway	---	0.0.0.0 (default), any value
IP Address Mode	---	Fixed
EtherNet/IP	---	Enabled
KeepAlive	Enabled (default)	---

* For the use cases in this document, setting the gateway is unnecessary because the devices are connected within the same segment of the network.

Set the code reader’s gateway setting to any value. It must not be left blank.

6.1.2. About the Code Reader Assemblies

The code reader has six types of Input Assemblies and two types of Output Assemblies, and one type can be selected for each.

The data structure changes based on the selected assembly.

Assembly Type	Assembly Name	Assembly Number
Input Assembly	Small Input Assembly	100
Input Assembly	Large Input Assembly	101
Input Assembly	MXL/SLC Input Assembly	102
Input Assembly	1 Decode Input Assembly	103
Input Assembly	4 Decode Input Assembly	104
Input Assembly	N Decode Input Assembly	105
Output Assembly	Output Assembly	197
Output Assembly	Output Assembly (Legacy)	198

For a detailed explanation of memory allocation and the data structure of each assembly, refer to *Appendices A-2 EtherNet/IP Specifications* in the *Autofocus Multicode Reader MicroHAWK V320-F/V330-F/V420-F/V430-F Series User Manual for Communication Settings* (Cat. No. Z407).

6.2. Data Types to Use for Tag Data Links

This section describes an example of using data types for the code reader's tag data link data.

<Input and Output Assemblies>

- Input Assembly: 1 Decode Input Assembly (103)
- Output Assembly: Output Assembly (197)

6.2.1. Output Area

The Output Area is an area where you can send commands to the code reader, such as trigger input commands and commands for registering Match strings.

- Definition of Output Area access data types (structure)

Data types for accessing the Output Area.

Name of data type	Data type	Code reader data
S_EIOutput197	STRUCT	---
COMMANDS	COMMAND	Control signal (32 bits)

- Definition of control signal area access data types (structure)

Data types for accessing the control signal area.

Name of data type	Data type	Code reader data
COMMAND	ARRAY[0..31] OF BOOL	---
Run_Mode	BOOL	Run Mode
Trigger	BOOL	Trigger
Enable_MatchCode	BOOL	Enable MatchCode
Omitted		
Output_2	BOOL	Output 2
Output_3	BOOL	Output 3
Reserved	ARRAY[0..17] OF BOOL	Reserved for future use

6.2.2. Input Area

The Input Area is an area where you can check the control status and output character strings of the code reader, such as Accept Trigger confirmation and Read OK/NG results.

- Definition of Input Area access data types (structure)

Data types for accessing the Input Area.

Name of data type	Data type	Code reader data
S_EIPInput103	STRUCT	---
INFO_BITS	BYTE	INFO BIT
RESERVED1	BYTE	Reserved for future use
RESERVED2	BYTE	Reserved for future use
RESERVED3	BYTE	Reserved for future use
DEVICE_STATUS	Device_Status	Status Signal (32 bits)
FAULT_CODE	DINT	Error code
COUNTERS	ARRAY[0..5] OF DINT	Read Count Information
READ_CYCLE_ REPORT	ARRAY[0..3] OF INT	Read Cycle Report
DECODE_CYCLE_ REPORT	ARRAY[0..3] OF DINT	Decode Cycle Report
DECODE_LENGTH	DINT	Decoded String Length
DECODE_DATA	ARRAY[0..435] OF BYTE *1	Decoded String

*1. The original data type is defined as "SINT". In this document, it is defined as "BYTE" that can be displayed in "ASCII" for readability when monitoring with the Watch Tab Page of Sysmac Studio.

■ Definition of Status Signal area access data types (structure)

Data types for accessing the Status Signal area.

Name of data type	Data type	Code reader data
Device_Status	ARRAY[0.31] OF BOOL	---
Run_Mode	BOOL	Run Mode
Trigger_Acknowledge	BOOL	Accept trigger
Exposure_Done	BOOL	Exposure Done
Omitted		
Output3_Status	BOOL	Output3 Status
Buffer_Overflow	BOOL	Buffer Overflow
Reserved	ARRAY [0..9] OF BOOL	Reserved for future use



Note

Please refer to *Appendices A-2 EtherNet/IP Specifications* in the *Autofocus Multicode Reader MicroHAWK V320-F/V330-F/V420-F/V430-F Series User Manual for Communication Settings* (Cat. No. Z407) for a description of how to use each bit.

6.3. Global Variables

The controller treats the data in tag data links as global variables. The settings for global variables are shown below.

The global variables below are set in the “project file”.

Variable	Network Publish	Data type	Application
EIOutput	Out	S_EIOutput197	For data links to the Output Area
EIInput	In	S_EIInput103	For data links to the Input Area

■ EIOutput Structure

Code reader data	Variable name	Data type
Control signal (32 bits)	EIOutput.COMMAND*1	BOOL[32]

*1. Control Signal Assignment

Variable: EIOutput.COMMAND Assignment

15	14	13	12	11	10	9	8	7	6	5	4	3	2	1	0
														TRIG	RUN_MODE
31	30	29	28	27	26	25	24	23	22	21	20	19	18	17	16

TRIG: Execute Read Bit: When ON, Read is executed.

RUN MODE: When ON, Trigger can be accepted and Read Cycle is enabled.

■ EIPInput Structure

Code reader data	Variable name	Data type
INFO BIT	EIPInput.INFO_BITS	BYTE
Reserved for future use	EIPInput.RESERVED1	BYTE
Reserved for future use	EIPInput.RESERVED2	BYTE
Reserved for future use	EIPInput.RESERVED3	BYTE
Status Signal (32 bits)	EIPInput.Device_status*1	BOOL[32]
Error code	EIPInput.FAULT	DINT
Read Count Information	EIPInput.COUNTERS	DINT[6]
Read Cycle Report	EIPInput. READ_CYCLE_REPORT	INT[4]
Decode Cycle Report	EIPInput. DECODE_CYCLE_REPORT	INT[8]
Decoded String Length	EIPInput.DECODE_LENGTH	DINT
Decoded String	EIPInput.DecodeData	BYTE[436]

*1. Control Signal Assignment

Variable: EIPInput.Device_status Assignment

15	14	13	12	11	10	9	8	7	6	5	4	3	2	1	0
											Datals Ready	Deco ding		Trigger Acknow ledge	Run Mode
31	30	29	28	27	26	25	24	23	22	21	20	19	18	17	16

RunMode: ON when in Read Cycle

Trigger Acknowledge: ON when Output Assembly Trigger Bit is received

Decoding: ON while image is being processed

DatalsReady: ON when Data Output and Judgment are verified



Note

The Sysmac Studio has two input methods to specify an array for a data type. If an array is specified in (1), it is converted to (2) after input, and the data type is always displayed in (2).

(1) BOOL[16] and (2) ARRAY[0..15] OF BOOL

In this document, the data type is described in BOOL[16] for simplicity.

(The example above means a BOOL data type with sixteen array elements.)

6.4. Tag Set

The settings of a tag set to use tag data links are shown below.

Set the data in the tag set in ascending order of the OUT No. or IN No. as shown below.

■ Output Area (Controller → Code Reader)

Originator Variable (Tag set name)		Data size (bytes)
EIPOutput		4
OUT No.	Global Variable Name (Tag name)	Data size (bytes)
1	EIPOutput	4

■ Input Area (Controller ← Code Reader)

Originator Variable (Tag set name)		Data size (bytes)
EIPIInput		500
IN No.	Global Variable Name (Tag name)	Data size (bytes)
1	EIPIInput	500

6.5. Tag Data Link Table

The contents of the tag data link table (connection settings) are shown below.

The values shown in the red frames are the values defined in the EDS file of the code reader.

Connection Name	Connection I/O Type	RPI (ms)	Timeout
default_001	Input 1 Decode	10.0	RPI x 32

Connection I/O Type	Input/Output	Target Variable	Size (bytes)	Originator Variable (Tag set name)	Size (bytes)	Connection Type
Input 1 Decode	In	103	500	EIPIInput	500	Point to Point connection
	Out	197	4	EIPOutput	4	Point to Point connection

7. EtherNet/IP Connection Procedure

This section describes the procedures for connecting the code reader and controller on an EtherNet/IP network.

In this document, it is assumed that the controller and the code reader use the factory default settings. For how to initialize the devices, refer to *Section 8. Initializing the System*.

7.1. Operation Flow

The procedures for setting up the EtherNet/IP tag data links are as follows.

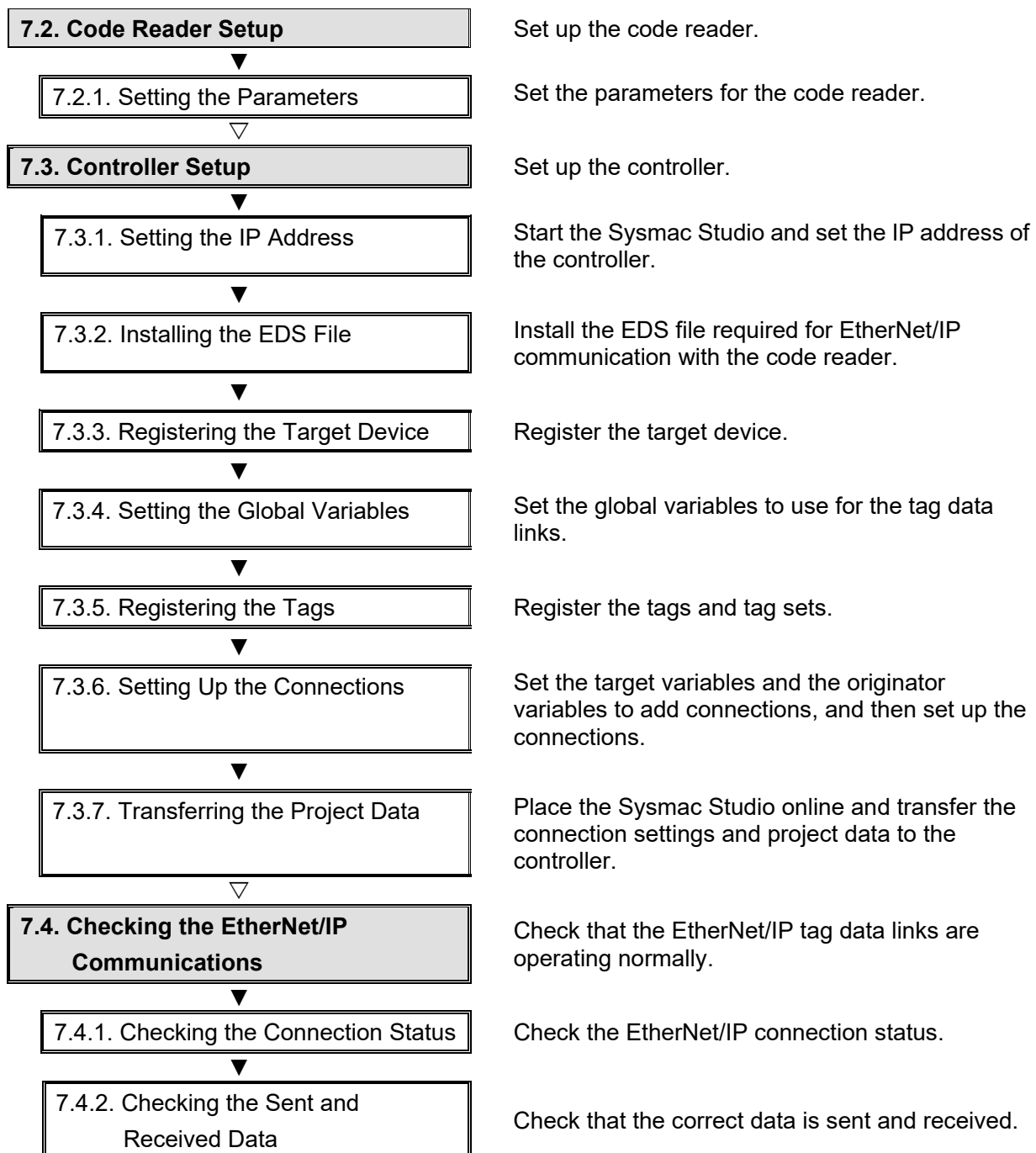

7.2. Code Reader Setup

Set up the code reader.

7.2.1. Setting the Parameters

Set the parameters for the code reader.

Set the IP address of your PC to 192.168.188.100 and its subnet mask to 255.255.0.0.

1 [Using V330-F]

Connect the cord reader and the switching hub to the PoE injector with a LAN cable.

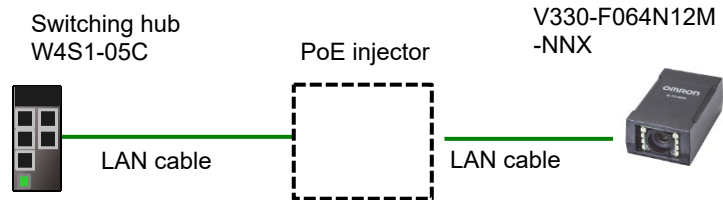

[Using V430-F]

Connect the Ethernet connector of the code reader to the switching hub with the Ethernet cable.

Connect the I/O cable to the I/O connector and turn ON the 24 VDC power supply.

* In this document, only the power supply wires of the I/O cable are connected and checked. Be careful not to short-circuit any other wires.

* Ground the shield wire as needed. For more information on grounding, please refer to *Grounding in Appendices of the MicroHAWK V320-F/V330-F/V420-F/V430-F Series Barcode Reader User Manual (Cat. No. Z432)*.

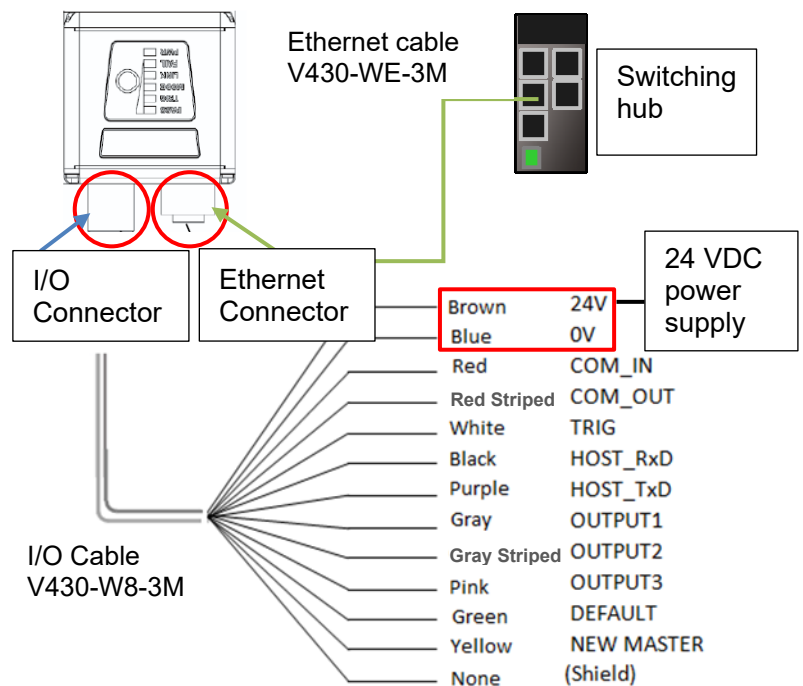

2 Connect the PC to the switching hub with a LAN cable.

Connect 24 VDC power supply (for the switching hub) to the switching hub.

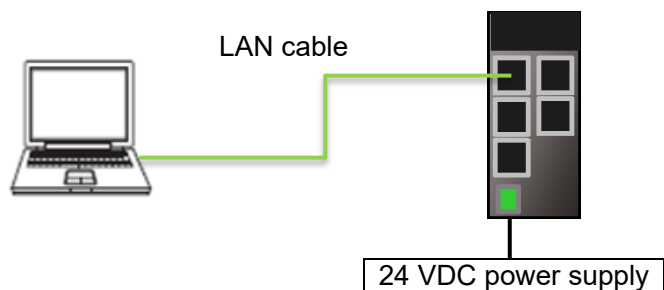

3 Set the IP Address of the PC.

For the IP address, enter

192.168.188.100.

For the subnet mask, enter

255.255.0.0.

For the procedure to open the screen on the right, please refer to *step 4.*

4 Static connection (Setting the fixed IP address)

(1) From the Windows **Start** Menu, select **Control Panel – Network and Internet – Network and Sharing Center**.

(2) Click on **Local Area Connection**. The **Local Area Connection Status** Dialog Box is displayed. Click **Properties**.

(3) In the **Local Area Connection Properties** Dialog Box, select *Internet Protocol Version 4 (TCP / IPv4)*, and click the **Properties** Button. Set the IP Address of the PC to *192.168.188.100.*

(4) Click the **OK** Button.

5 Start your browser and enter

http://192.168.188.2.

“Google Chrome” is the recommended browser.

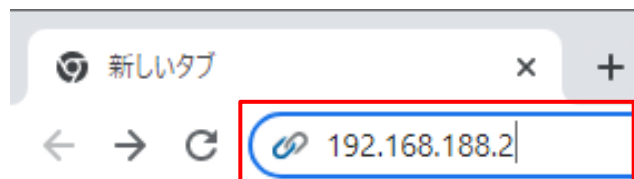

- 6** When the WebLink startup screen is displayed, go to step 8.

If the WebLink startup screen does not appear, go to step 7.



- 7** If the WebLink startup screen does not appear, it means that communications are not established between the code reader and the PC. Please check the following.

- Does the code reader and the PC have a proper physical (cable) connection?
- Are the IP Addresses of the PC and code reader set correctly?
→ Refer to *step 4* for setting the IP address of the PC.
- Do a hardware reset of the code reader.
→ When turning ON the power supply, press and hold the setup button on the code reader body until its light turns on.

For other measures that can be taken, please refer to *When unable to access by WebLink in Q&A in Appendices of the MicroHAWK V320-F/V330-F/V420-F/V430-F Series Barcode Reader User Manual (Cat. No. Z432)*.

- 8** The WebLink screen appears.

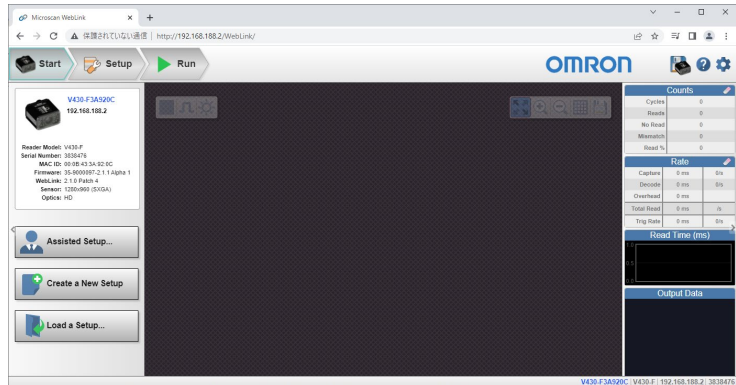

- 9** Click on the **Setup** tab and, in **Read Cycle Sequence**, set **Cycle to Triggered**.

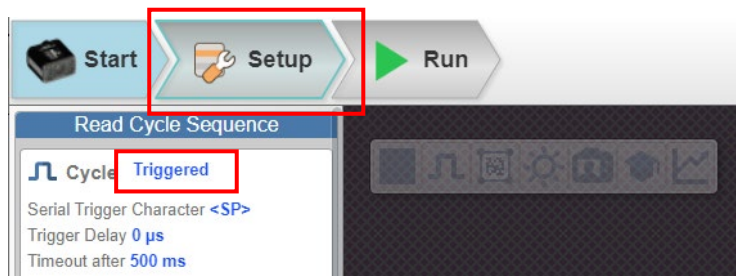

10 Click on the gear icon on the upper right of the screen to select **Advanced**.

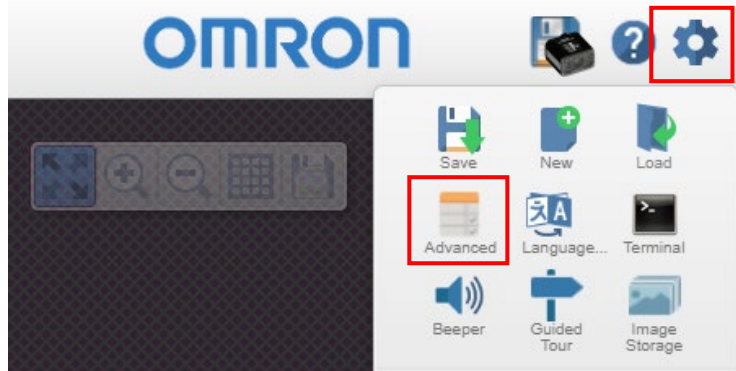

11 The Advanced Settings Screen appears. Check the settings shown in the red frames. EtherNet/IP connection is Enabled by default, so you do not need to change the settings with the default setting.

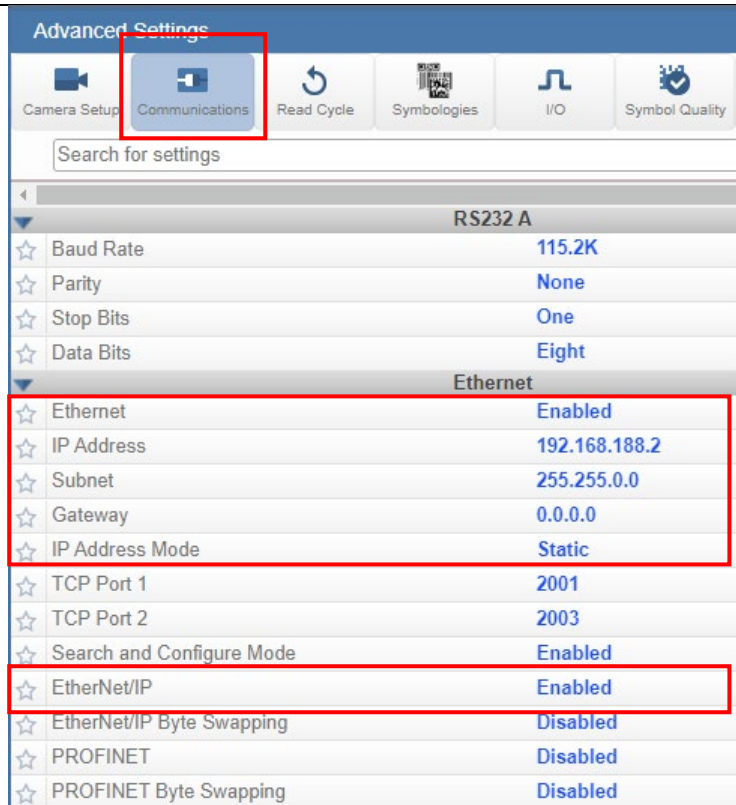

12 Click on the icon shown in the red frame to save the settings to the code reader.



13 Finally, check the version number of the code reader. Click on the gear icon on the upper right of the screen and select **About WebLink**.

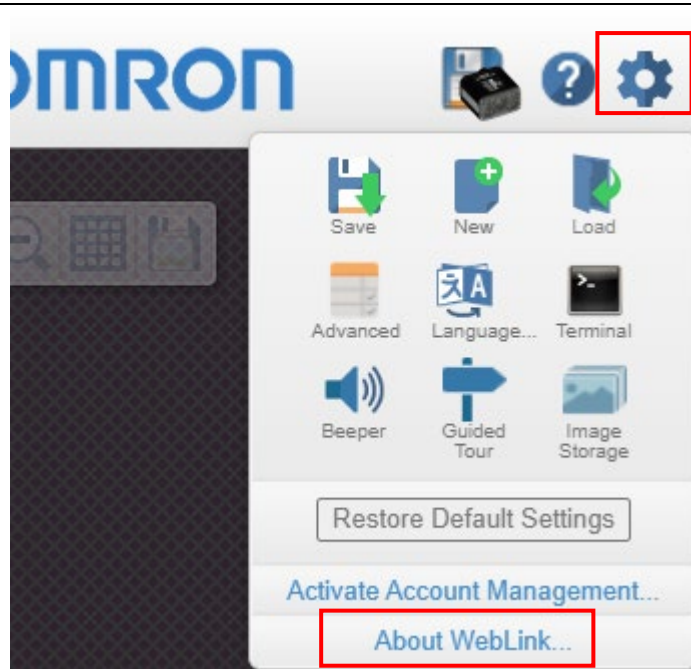

14 **About WebLink** is displayed, so you can check the current version of the code reader.

Please update the code reader to the latest version if necessary.



7.3. Controller Setup

Set up the controller.

7.3.1. Setting the IP Address

Start the Sysmac Studio and set the IP address of the controller.
Install the Sysmac Studio and USB driver on the PC beforehand.

- 1 Connect a LAN cable to the Built-in EtherNet/IP Port (PORT1) and a USB cable to the peripheral (USB) port of the controller, and connect a PC and a switching hub to the controller as shown in 5.2. *Device Configuration.*

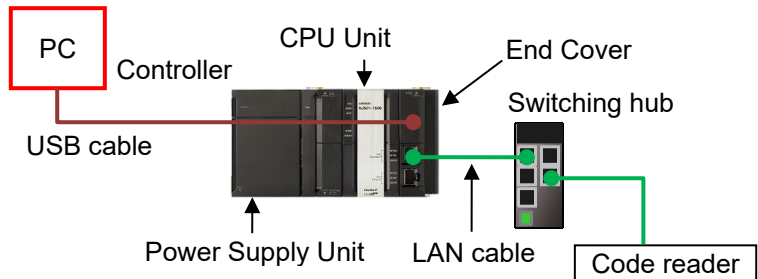

- 2 Start the Sysmac Studio.
* If a user account control dialog box is displayed at startup, select the option to start.



- 3 Start the Sysmac Studio.
Click **New Project**.

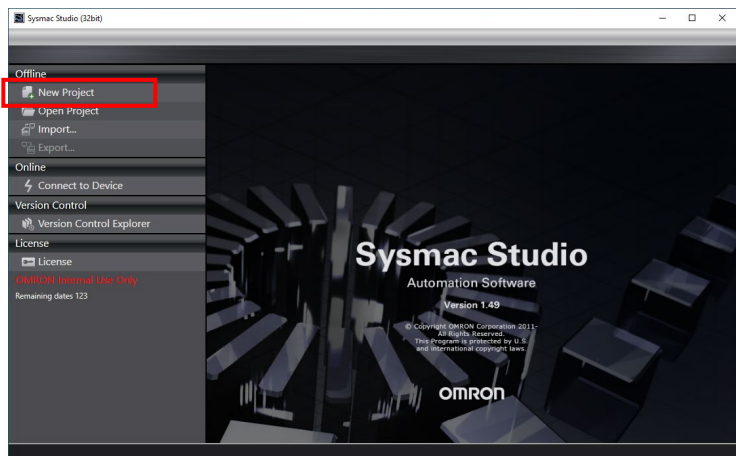

4 The **Project Properties** Screen is displayed.

* This document assumes that the project name is *New Project*.

Make sure that, in **Select Device, Category and Device** are set for the device to use.

Select an applicable version from the **Version** pull-down list.

* Although *1.19* is selected as an example in this document, select the version you actually use.

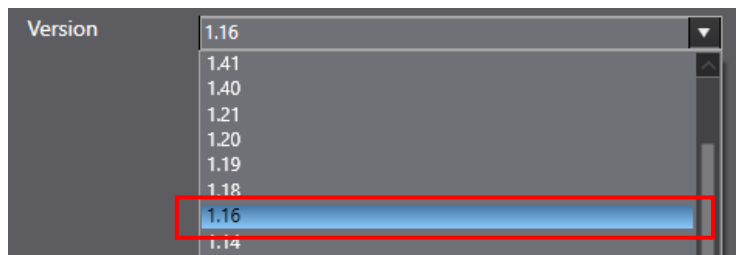
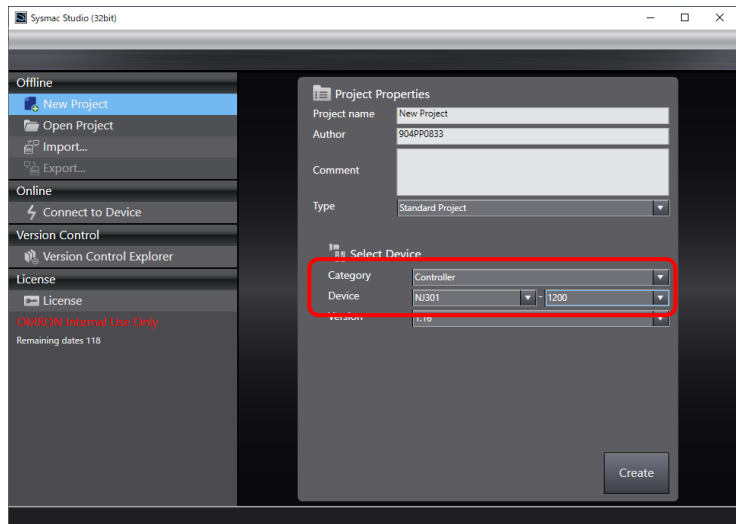

5 Click **Create**.

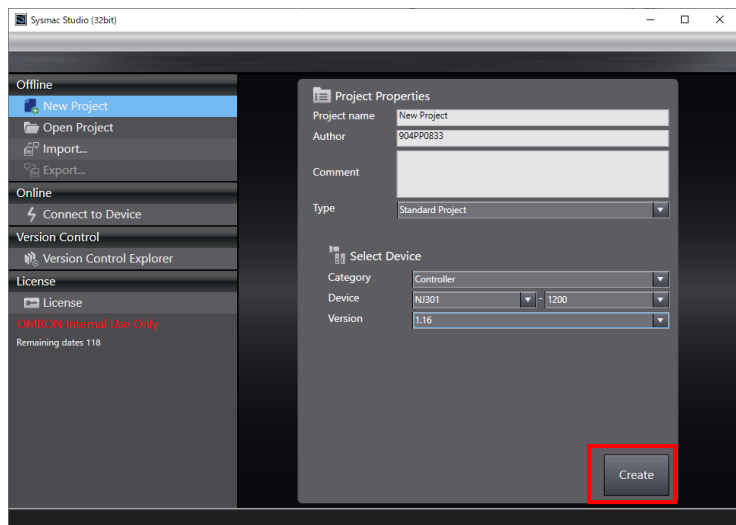

6 The **New Project** Window is displayed.

This window consists of the following panes.

- Left: Multiview Explorer
- Upper right: Toolbox
- Lower right: Controller Status Pane
- Top middle: Edit Pane
- In the lower center of the window, the tabs for the following tab pages are displayed.
- Output Tab Page
- Build Tab Page

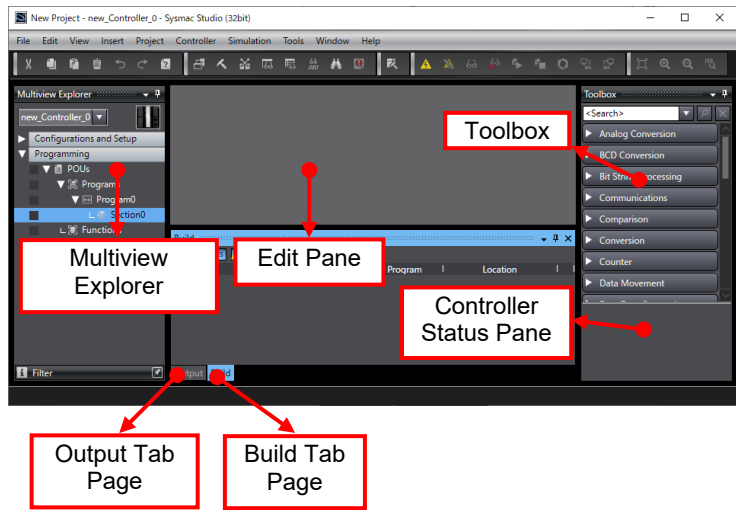

7 Double-click **Built-in EtherNet/IP Port Settings** under **Configurations and Setup – Controller Setup** in the Multiview Explorer.

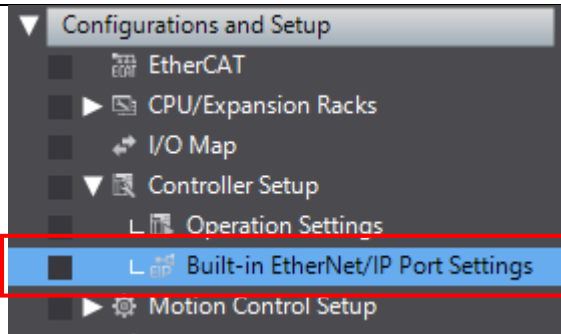

8 The **Built-in EtherNet/IP Port Settings** Tab Page is displayed in the Edit Pane.
 In **IP Address**, set the following information.
 IP address: 192.168.188.200
 Subnet mask: 255.255.0.0

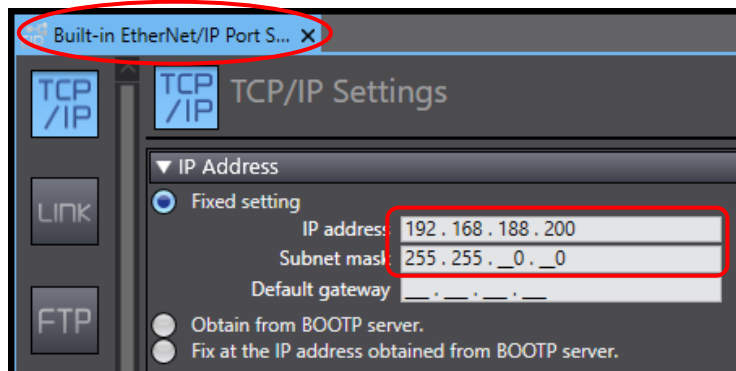

7.3.2. Installing the EDS File

Install the EDS file.

The EDS file can be downloaded from the OMRON web page.

Note that, for V430, the required EDS file differs depending on the version.

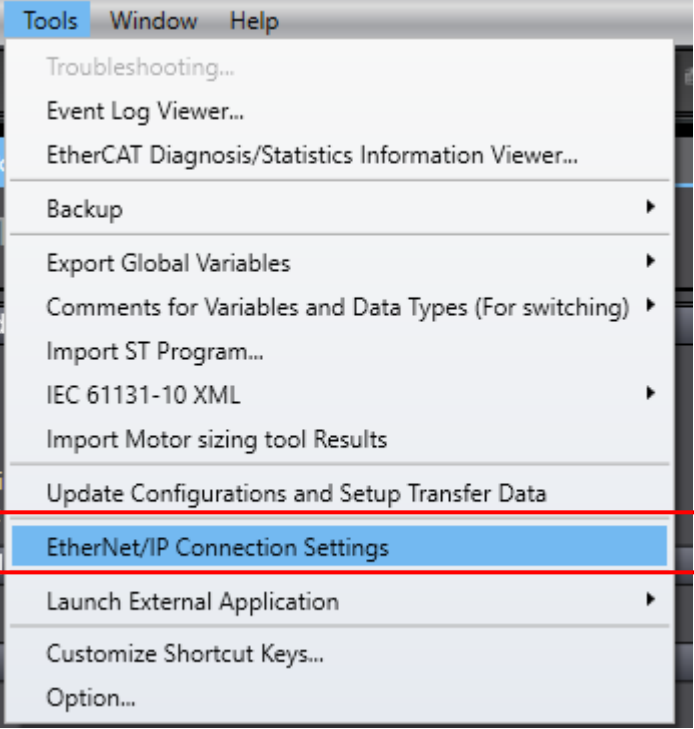
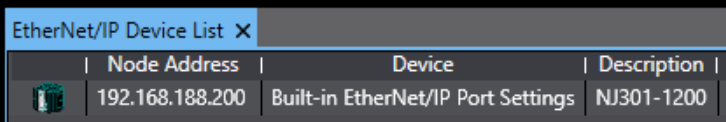
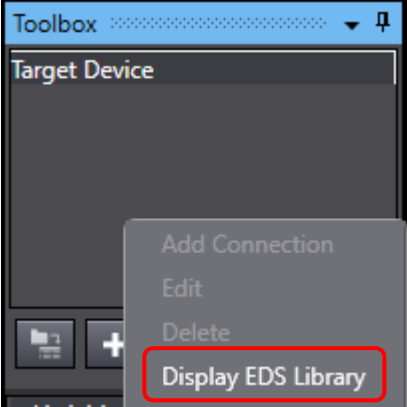
<p>1 Select EtherNet/IP Connection Settings from the Tools Menu.</p>	 <p>The screenshot shows the 'Tools' menu in a software application. The menu items are: Troubleshooting..., Event Log Viewer..., EtherCAT Diagnosis/Statistics Information Viewer..., Backup, Export Global Variables, Comments for Variables and Data Types (For switching), Import ST Program..., IEC 61131-10 XML, Import Motor sizing tool Results, Update Configurations and Setup Transfer Data, EtherNet/IP Connection Settings (highlighted with a red box), Launch External Application, Customize Shortcut Keys..., and Option...</p>						
<p>2 Double-click Built-in EtherNet/IP Port Settings.</p>	 <table border="1"> <thead> <tr> <th>Node Address</th> <th>Device</th> <th>Description</th> </tr> </thead> <tbody> <tr> <td>192.168.188.200</td> <td>Built-in EtherNet/IP Port Settings</td> <td>NJ301-1200</td> </tr> </tbody> </table>	Node Address	Device	Description	192.168.188.200	Built-in EtherNet/IP Port Settings	NJ301-1200
Node Address	Device	Description					
192.168.188.200	Built-in EtherNet/IP Port Settings	NJ301-1200					
<p>3 In the Toolbox, right-click on Target Device and select Display EDS Library.</p>	 <p>The screenshot shows the 'Toolbox' window with a 'Target Device' section. A context menu is open over the 'Target Device' area, showing options: Add Connection, Edit, Delete, and Display EDS Library (highlighted with a red box).</p>						

4 The EDS Library Dialog Box is displayed. Select **Install**.

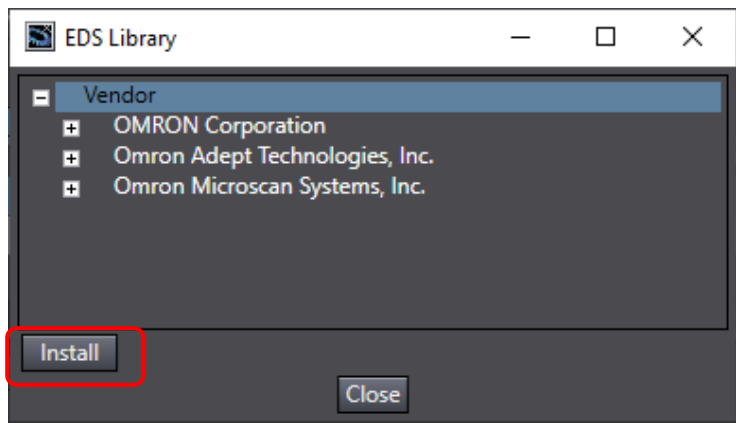

5 Select the EDS file that you downloaded and then select **Open**.

Note that there are two EDS files, one for V330-F and the other for V430-F.

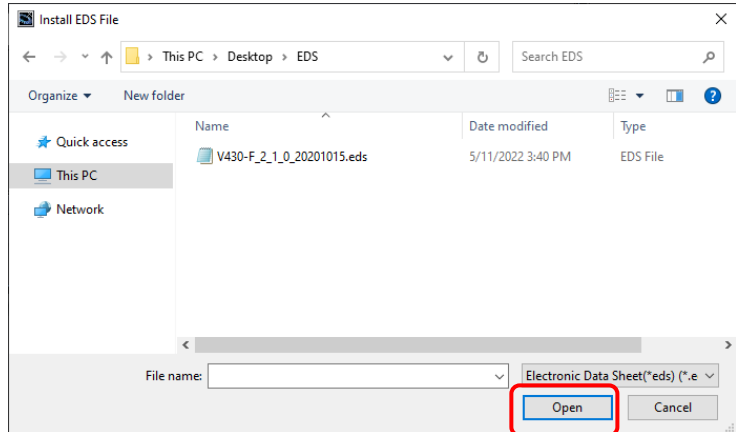

6 Check that the selected EDS file for **V330-F** or **V430-F** is installed in **Microscan Systems, Inc. – Generic Device**.

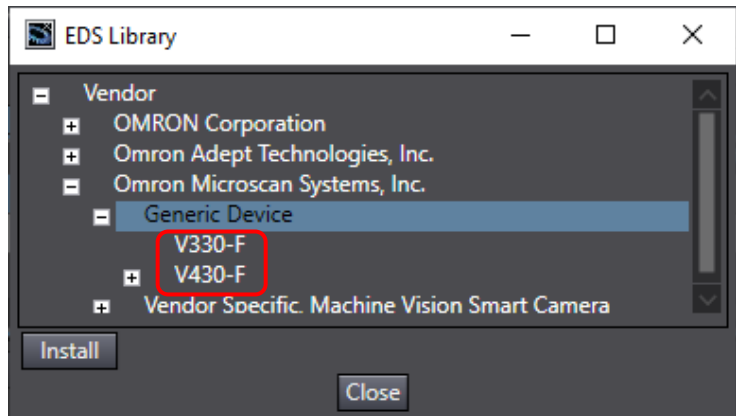

7.3.3. Registering the Target Device

Register the target device.

- 1** Select **EtherNet/IP Connection Settings** from the **Tools** Menu.

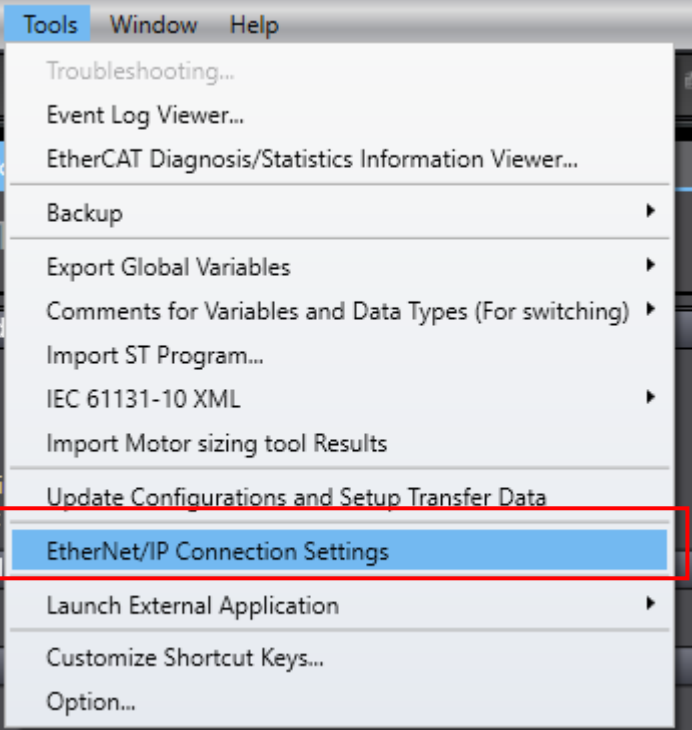

The screenshot shows the 'Tools' menu open. The 'EtherNet/IP Connection Settings' option is highlighted in blue and enclosed in a red rectangular box. Other menu items include Troubleshooting..., Event Log Viewer..., EtherCAT Diagnosis/Statistics Information Viewer..., Backup, Export Global Variables, Comments for Variables and Data Types (For switching), Import ST Program..., IEC 61131-10 XML, Import Motor sizing tool Results, Update Configurations and Setup Transfer Data, Launch External Application, Customize Shortcut Keys..., and Option...
- 2** In the Edit Pane, the **EtherNet/IP Device List** Tab Page is displayed. Right-click on **Built-in EtherNet/IP Port Settings** and select **Edit** from the menu.

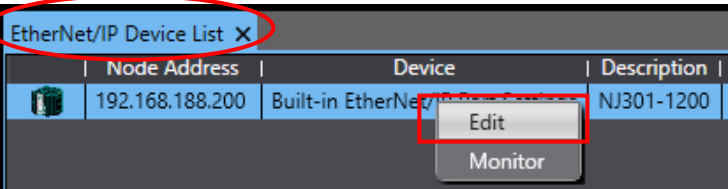

The screenshot shows a table titled 'EtherNet/IP Device List'. The table has columns for Node Address, Device, and Description. One row is visible with Node Address 192.168.188.200, Device Built-in EtherNet/IP Port Settings, and Description NJ301-1200. A right-click context menu is open over the 'Built-in EtherNet/IP Port Settings' cell, with the 'Edit' button highlighted in a red box. The table header is as follows:

Node Address	Device	Description
192.168.188.200	Built-in EtherNet/IP Port Settings	NJ301-1200
- 3** The **Built-in EtherNet/IP Port Settings Connection Settings** Tab Page appears in the Edit Pane.

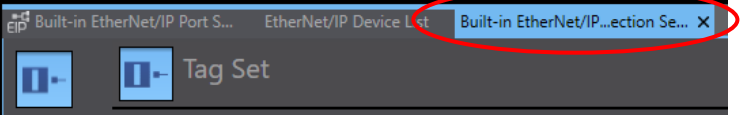

The screenshot shows the software interface with several tabs. The 'Built-in EtherNet/IP Port Settings Connection Settings' tab is selected and highlighted with a red oval. Other visible tabs include 'EtherNet/IP Device List' and 'Tag Set'.
- 4** Click on **+** in the Toolbox.

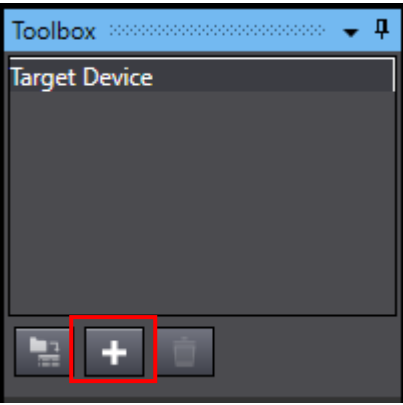

The screenshot shows the 'Toolbox' window. At the bottom of the toolbox, there is a '+' button highlighted with a red box, along with other icons for file operations.

- 5** The target device registration dialog box appears.

In **Node address**, enter *192.168.188.2*.

In **Model name** and **Revision**, set the following values by clicking on the corresponding field and selecting from the pull-down menu.

Model name: V330-F or V430-F

Revision: 1 or 2

Here, the model name V430-F, revision 2 is selected.

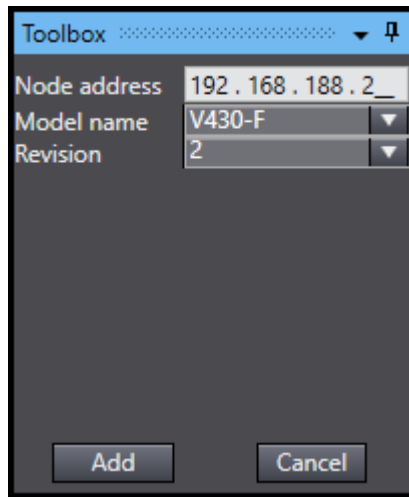

Toolbox

Node address 192.168.188.2

Model name V430-F

Revision 2

Add Cancel

- 6** Check the settings and click **Add**.

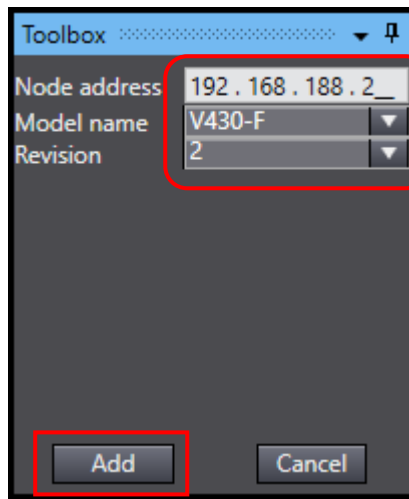

Toolbox

Node address 192.168.188.2

Model name V430-F

Revision 2

Add Cancel

- 7** *192.168.188.2* is registered in **Target Device** in the Toolbox.

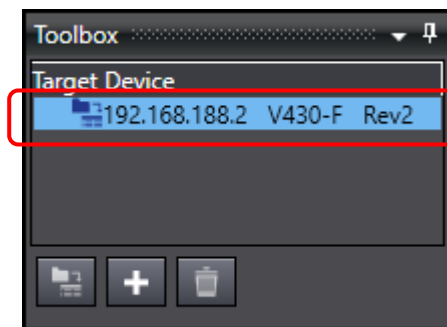

Toolbox

Target Device

192.168.188.2 V430-F Rev2

+ -

7.3.4. Setting the Global Variables

Set the global variables to use for the tag data links.

An example of using the following assemblies is shown here.

- Input Assembly: 1 Decode Input Assembly (103)
- Output Assembly: Output Assembly (197)

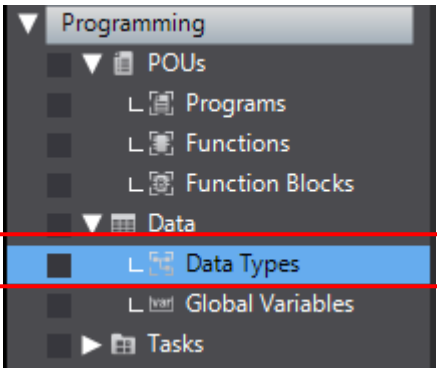
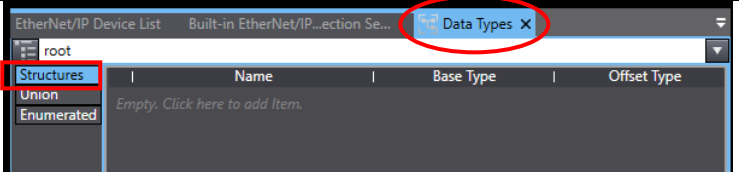
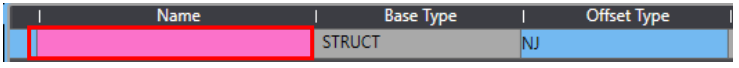
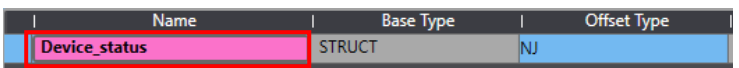
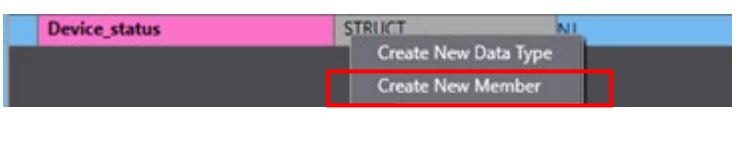
<p>1 Double-click Data Types under Programming – Data in the Multiview Explorer.</p>	
<p>2 The Data Types Tab Page is displayed. Click on Structures. The Structures Tab Page appears.</p> <p>Click in the Name field to enter a new data type.</p> <p>In the Name field, enter <i>Device_status</i>.</p>	  
<p>3 After confirming the entry, right-click in the field and select Create New Member from the menu.</p>	

4 Create a data type to check the Status Signal details of the Input Assembly.

In **Name** and **Base Type**, enter the name and data type of each signal as shown in the figure on the right.

Assign also the byte offset and bit offset values in **Offset Byte** and **Offset Bit** as shown in the figure.

For a detailed explanation of **Device_status** shown in the figure on the right, refer to *Appendices A-2 EtherNet/IP Specifications* in the *Autofocus Multicode Reader MicroHAWK V320-F/V330-F/V420-F/V430-F Series User Manual for Communication Settings* (Cat. No. Z407).

Name	Base Type	Offset Type	Offset Byte	Offset Bit
Device_status	STRUCT	User		
Run_Mode	BOOL		0	0
Trigger_Acknowledged	BOOL		0	1
Exposure_Done	BOOL		0	2
Decoding	BOOL		0	3
Data_Is_Ready	BOOL		0	4
Read_Cycle_Pass	BOOL		0	5
Read_Cycle_Fail	BOOL		0	6
General_Fault	BOOL		0	7
New_Match_Code_Acknowledg...	BOOL		1	0
Match_Code_Enabled	BOOL		1	1
Image_Sensor_Calibrating	BOOL		1	2
Image_Sensor_Calibration_Com...	BOOL		1	3
Training	BOOL		1	4
Training_Complete	BOOL		1	5
Optimizing	BOOL		1	6
Optimization_Complete	BOOL		1	7
AutolImage_Photometry_Enabled	BOOL		2	0
AutolImage_Photometry_Compl...	BOOL		2	1
Output1_Status	BOOL		2	2
Output2_Status	BOOL		2	3
Output3_Status	BOOL		2	4
Buffer_Overflow	BOOL		2	5
Reserved	ARRAY[0..9] OF BOOL		2	6

5 Right-click in the tab page and select **Create New Data Type**.

In the **Name** field, enter *S_EIPInput103*.

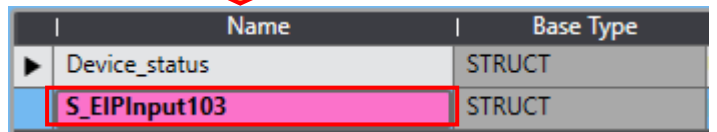
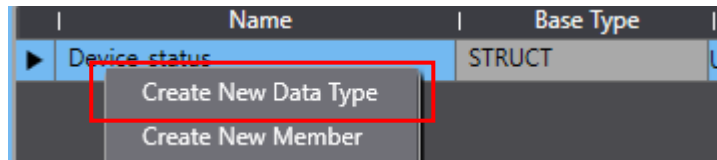

6 After confirming the entry, right-click in the field and select **Create New Member** from the menu.

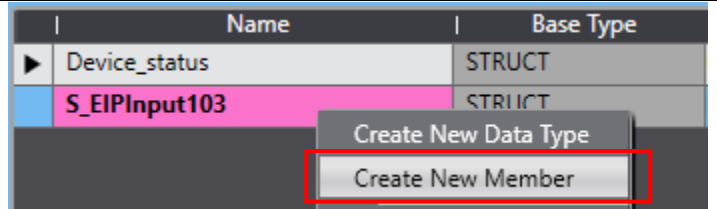

7 In **Name** and **Base Type**, enter the name and data type of each signal as shown in the figure on the right.

For a detailed explanation of the signals shown in the figure on the right, refer to *Appendices A-2 EtherNet/IP Specifications* in the *Autofocus Multicode Reader MicroHAWK V320-F/V330-F/V420-F/V430-F Series User Manual for Communication Settings* (Cat. No. Z407).

Name	Base Type	Offset Type	Offset Byte	Offset Bit
▶ Device_status	STRUCT	User		
▼ S_EIPInput103	STRUCT	NJ		
INFO_BITS	SINT			
RESERVED_1	SINT			
CONFIGURATION_CHANGE_DE...	SINT			
RESERVED_2	BYTE			
DEVICE_STATUS	Device_status			
FAULT_CODE	DINT			
COUNTERS	ARRAY[0..5] OF DINT			
READ_CYCLE_REPORT	ARRAY[0..3] OF INT			
DECODE_CYCLE_REPORT	ARRAY[0..3] OF INT			
CODE_TYPE	DINT			
PIXELS_PER_ELEMENT	REAL			
DECODE_LENGTH	DINT			
DECODE_DATA	ARRAY[0..435] OF B...			

8 As in steps 5 to 7, create new data types and members.

Here, we create data types for the Output Assembly to control the code reader, such as trigger input bits.

Assign also the byte offset and bit offset values in **Offset Byte** and **Offset Bit** as shown in the figure.

For a detailed explanation of the signals shown in the figure on the right, refer to *Appendices A-2 EtherNet/IP Specifications* in the *Autofocus Multicode Reader MicroHAWK V320-F/V330-F/V420-F/V430-F Series User Manual for Communication Settings* (Cat. No. Z407).

Name	Base Type	Offset Type	Offset Byte	Offset Bit
▶ Device_status	STRUCT	User		
▶ S_EIPInput103	STRUCT	NJ		
▼ COMMAND	STRUCT	User		
Run_Mode	BOOL		0	0
Trigger	BOOL		0	1
Enable_MatchCode	BOOL		0	2
Reset_General_Fault	BOOL		0	3
Clear_No_Read_ReadCycle_Count	BOOL		0	4
Clear_MisMatch_ReadCycle_Co...	BOOL		0	5
Clear_No_Read_Count	BOOL		0	6
Clear_Trigger_Count	BOOL		0	7
Clear_Matchcode_Count	BOOL		1	0
Clear_MisMatch_Count	BOOL		1	1
Output_1	BOOL		1	2
Output_2	BOOL		1	3
Output_3	BOOL		1	4
Reserved	ARRAY[0..17] OF B...		1	5
▼ S_EIPOutput197	STRUCT	NJ		
COMMANDS	COMMAND			

9 Double-click **Programming – Data – Global Variables** in the Multiview Explorer.

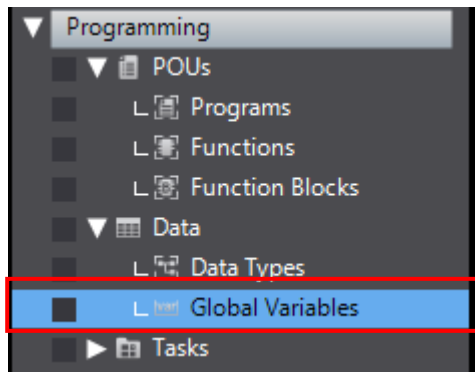

10 The **Global Variables** Tab Page is displayed in the Edit Pane.

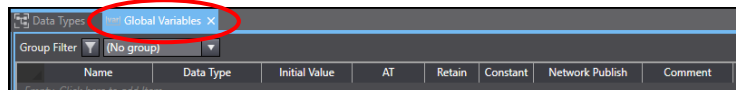

Click in the **Name** field to enter a new variable.

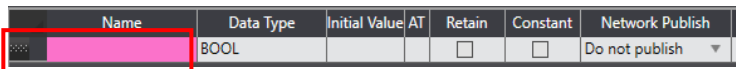

In the **Name** field, enter *EIPOutput*.

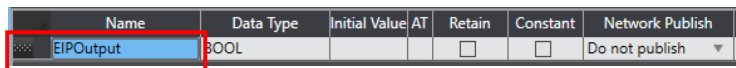

In the **Data Type** field, enter *S_EIPOutput197*.

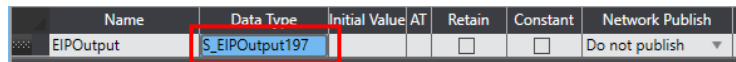

In the **Network Publish** field, select **Output** from the menu.

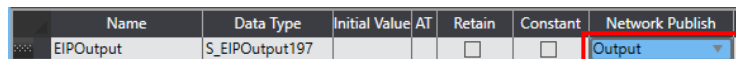
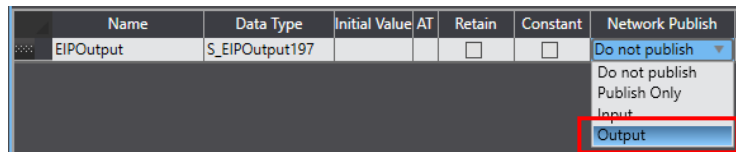

11 After confirming the entry, right-click in the field and select **Create New** from the menu.

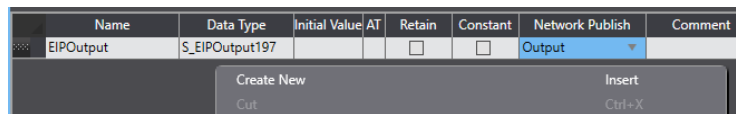

12 As in steps 2 to 3, enter the following data for the newly created area.

- Name: *EIPInput*
- Data type: *S_EIPInput103*
- Network Publish: *Input*

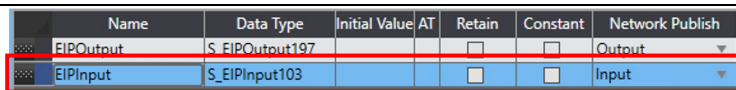

13 Double-click **Configurations and Setup – Task Settings** in the Multiview Explorer. The **Task Settings** Tab Page is displayed in the Edit Pane. Click on **VAR**.

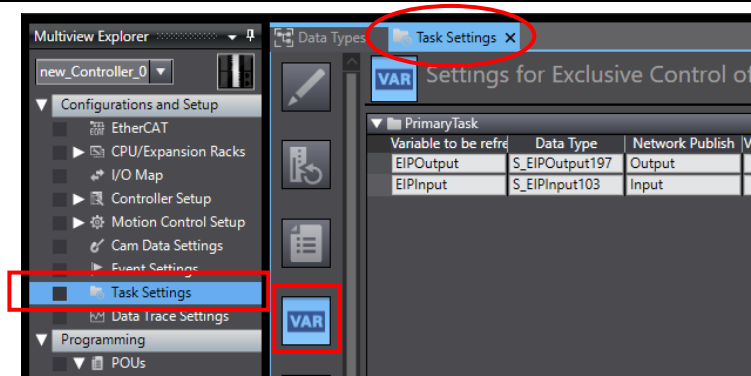

14 Click on **+**.

The new area is added. Click on the down arrow in the **Variable to be refreshed** field for the added area (on the left side of the tab page).

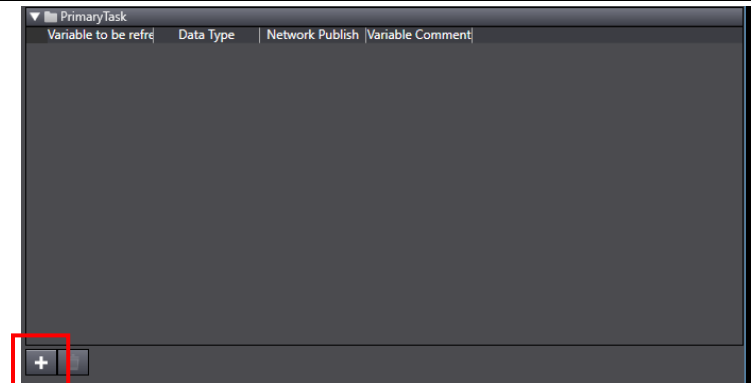

The variables set in this section are displayed. Select **EIOutput**.

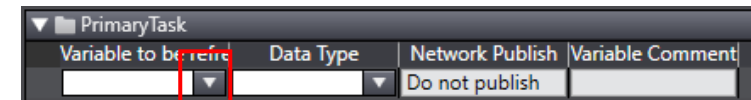

EIOutput is added.

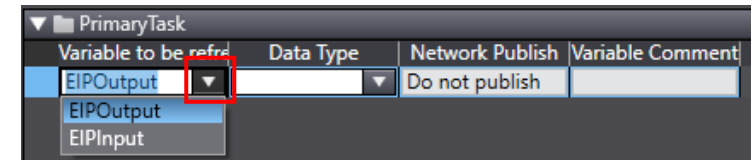

* Data Type is automatically set. No value needs to be entered.

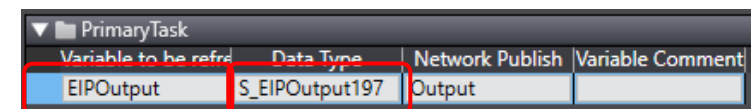

15 Using the same procedure as in step 6, add all the variables set in this section to **Variable to be refreshed** (on the left side of the tab page).

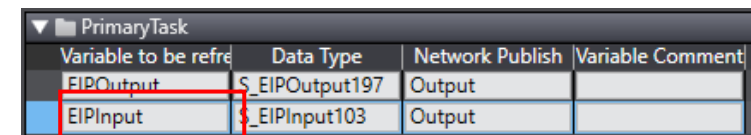



* Data Type is automatically set. No value needs to be entered.

7.3.5. Registering the Tags

Register the tags and tag sets.

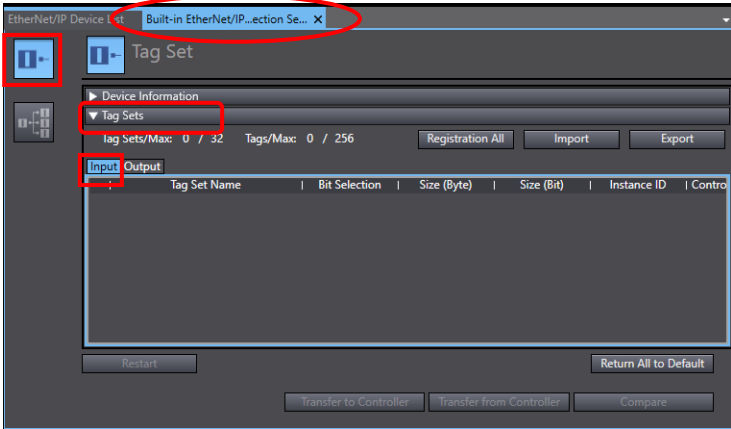
- 1** In the **Built-in EtherNet/IP Port Settings Connection Settings** Tab Page, select **Tag Set**. In **Tag Sets**, select the **Input** Tab Page.

- 2** Right-click in the **Input** Tab Page and select **Create New Tag Set** from the menu.

- 3** You can now enter a new tag set name. Select the newly added Input Area.

Enter *EIPInput*.

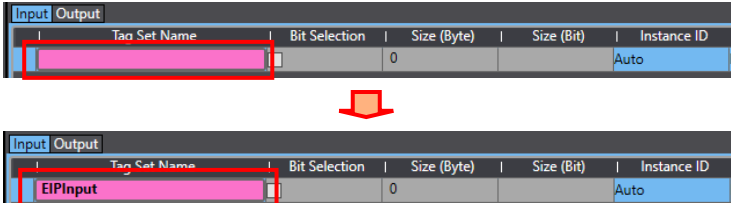
- 4** Right-click on **EIPInput** and select **Create New Tag** from the menu.

Under **EIPInput**, you can now enter a new tag name. Select the newly added Input Area.

Enter *EIPInput* to set it as a tag.

* For preset variables, entering the first letter displays a list of the matching names as shown in the figure on the right.

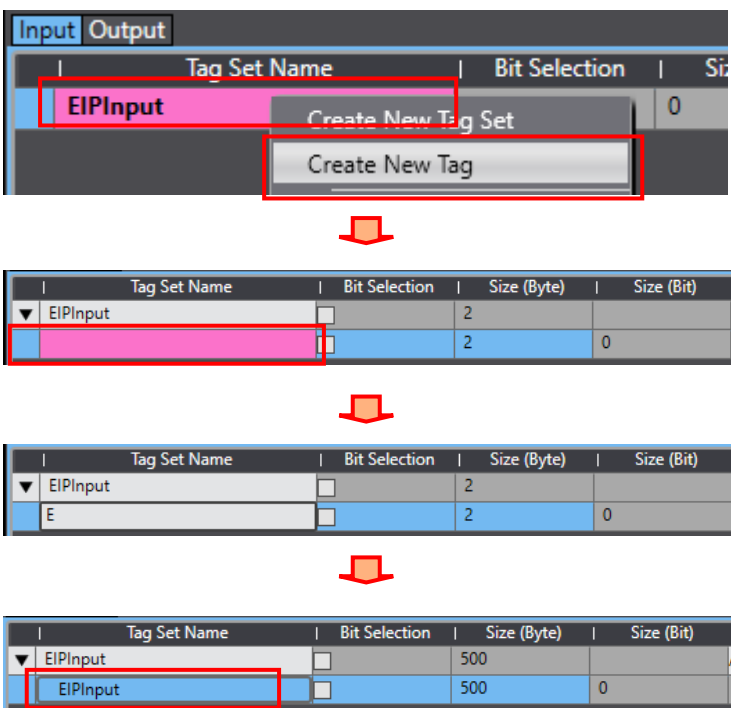

- 5** Select the **Output** Tab Page. Right-click in the **Output** Tab Page and select **Create New Tag Set** from the menu.

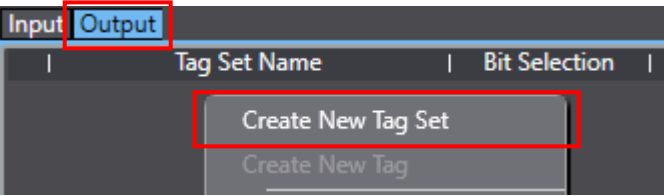
- 6** You can now enter a new tag set name. Using the same procedure as in step 3, enter *EIPOutput*.

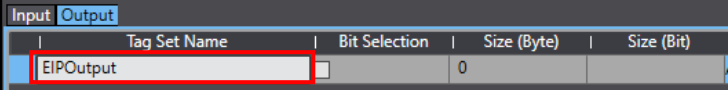
- 7** Using the same procedures as in step 4, add the global variable as a tag in order of the OUT No. shown in 6.4. *Tag Set*.

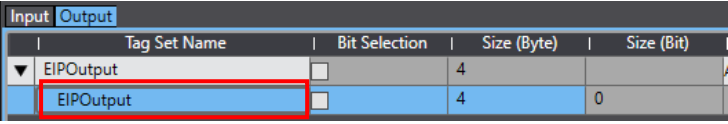
- 8** Confirm that **2** is shown for both **Tag Sets** and **Tags**.

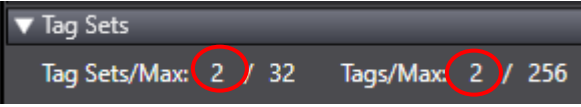

7.3.6. Setting Up the Connections

Set the target variables (the side on which connections are to be established) and the originator variables (the side on which you want to establish connections) to add connections, and then set up the connections (in the tag data link table).

<p>1 In the Built-in EtherNet/IP Port Settings Connection Settings Tab Page, select Connection.</p>	
<p>2 Right-click in Connection and select Add from the menu.</p>	
<p>3 You can now enter a new connection. Select the newly added Input Area.</p> <p>From the Target Device pull-down menu, select 192.168.188.2.</p>	
<p>4 A new connection named default_001 is created. In the Connection I/O Type field, select Input 1 Decode.</p>	
<p>5 You can now set the Target Variable and Originator Variable fields.</p>	

6 Click in the **Target Variable** field for **Input**.

Input/Out	Target Variable	Size [Byte]	Originator Variable	Size [Byte]
Input				---
Output				---

Press the **Ctrl + Space** Keys on the keyboard to display available assembly numbers.

* Entering even the first character **1** displays a list of matching assembly numbers.

Select the assembly number.

Input/Out	Target Variable	Size [Byte]	Originator Variable	Size [Byte]
Input	1			---
Output	100			---
	101			
	102			
	103			
	104			
	105			

In the same way, select the **Target Variable** field for **Output**.

Input/Out	Target Variable	Size [Byte]	Originator Variable	Size [Byte]
Input	103	500		---
Output				---

Input/Out	Target Variable	Size [Byte]	Originator Variable	Size [Byte]
Input	103	500		---
Output	197	4		---

7 Click in **Originator Variable** field for **Input**.
A list of available tag set names is displayed. Select the one to use.

Input/Out	Target Variable	Size [Byte]	Originator Variable	Size [Byte]
Input	103	500		---
Output	197	4	EIPInput	---

In the same way, set the **Originator Variable** field for **Output**.

Input/Out	Target Variable	Size [Byte]	Originator Variable	Size [Byte]
Input	103	500	EIPInput	500
Output	197	4	EIPOutput	4

8 Set the **Connection Type**, **RPI[ms]**, and **Timeout Value** fields as needed.

Originator Variable	Size [Byte]	Connection Type	RPI [ms]	Timeout Value
EIPInput	500	Point to Point connection	50.0	RPI x 4
EIPOutput	4	Point to Point connection		

9 Confirm that **2** is shown for **Connections**.

▼ Connection
Connections/Max: 2 / 32

7.3.7. Transferring the Project Data

Place the Sysmac Studio online and transfer the connection settings and project data to the controller.

WARNING

When you transfer a user program, Configurations and Setup data, device variables, or memory values for CJ Units from the Sysmac Studio, the devices and machines may operate unexpectedly regardless of the operating mode of the CPU Unit.

Before transferring the project data, check the safety of the destination slaves.

- 1** Turn ON the power supply to the controller, switching hub, and code reader.
- 2** Select **Check All Programs** from the **Project** Menu.

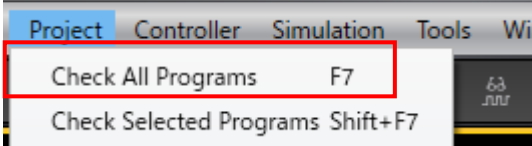
- 3** The **Build** Tab Page is displayed. Confirm that **0** is shown for both **Errors** and **Warnings**.

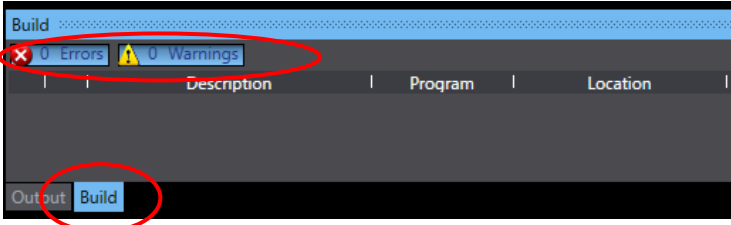

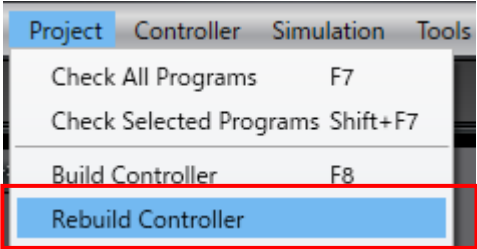
- 4** Select **Rebuild Controller** from the **Project** Menu.

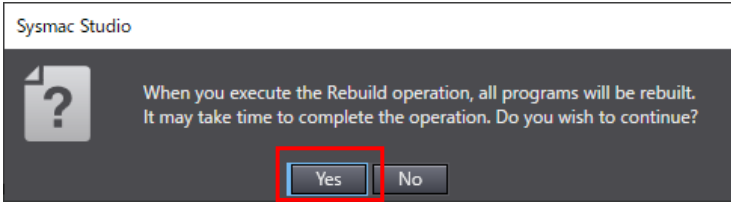
- 5** A confirmation dialog box appears. Confirm the information and click the **Yes** Button.

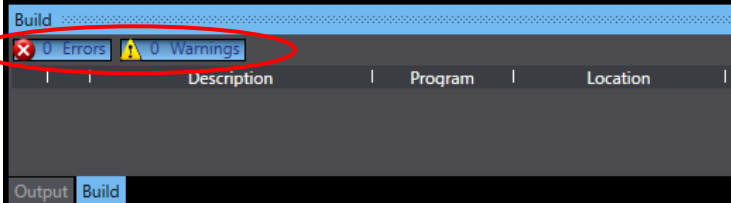

- 6** In the **Build** Tab Page, confirm that **0** is shown for both **Errors** and **Warnings**.

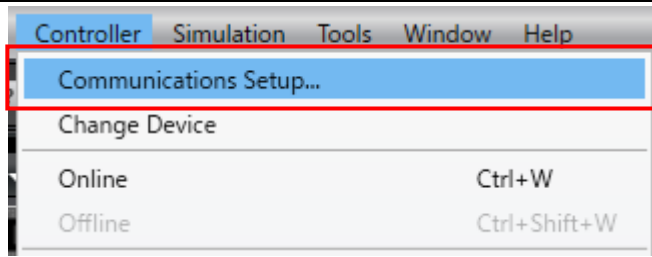

- 7** Select **Communications Setup** from the **Controller** Menu.

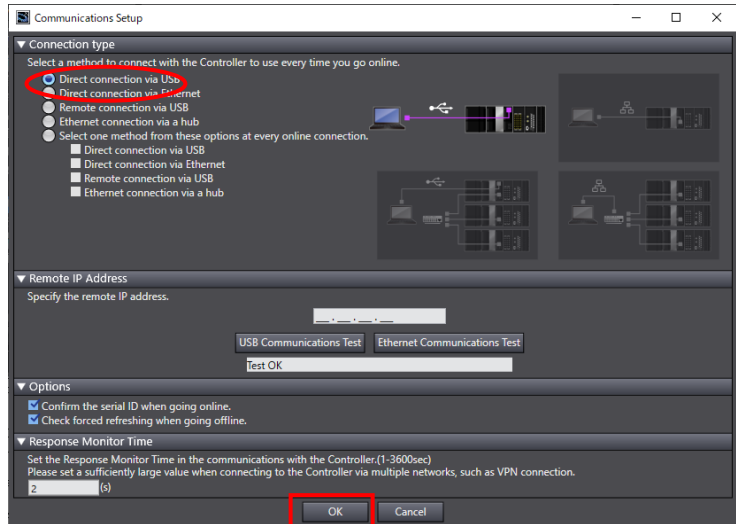

- 8** The **Communications Setup** Dialog Box is displayed. Make sure that the **Direct connection via USB** Option is selected in **Connection type**. Click **OK**.



- 9** Select **Online** from the **Controller** Menu. A confirmation dialog box appears. Confirm the information and click **Yes**.

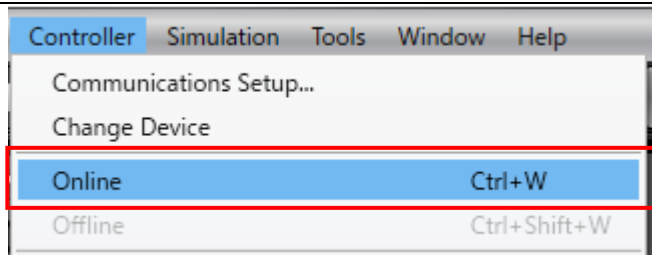

* The dialog box displayed differs depending on the status of the controller being used. Read the information and select **Yes** or **No** to proceed with the operation.

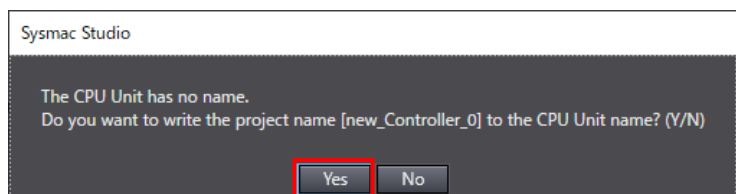

- 10** When you are online, a yellow frame appears in the upper part of the Edit Pane.



Note

Refer to *Section 6 Online Connections to a Controller* in the *Sysmac Studio Version 1 Operation Manual* (Cat. No. W504) for details on online connection to the controller.

11 Select **Synchronization** from the **Controller** Menu.

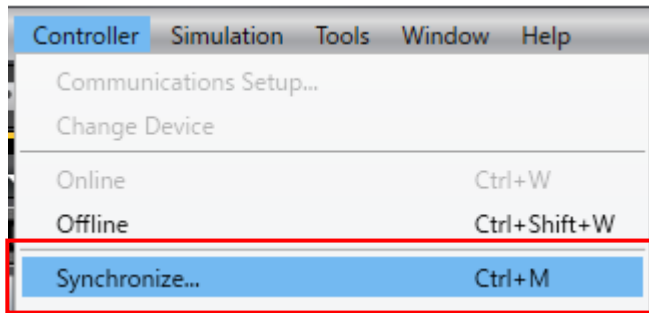

12 The **Synchronization** Dialog Box is displayed. Confirm that the data to transfer is selected. (In the figure on the right, the check box for **NJ301** is selected.)

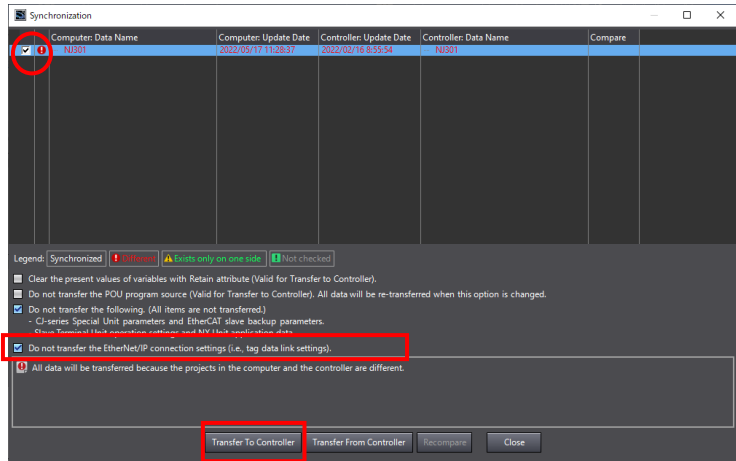

Clear the check box for **Do not transfer the EtherNet/IP connection settings (i.e., tag data link settings)**. Click the **Transfer to Controller** Button.

* Executing **Transfer to Controller** transfers the data from the Sysmac Studio to the controller for data comparison.

13 A confirmation dialog box appears. Confirm that there is no problem and click the **Yes** Button.

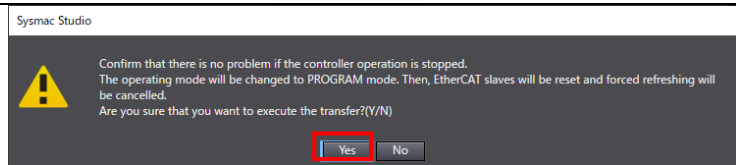

The **Synchronizing** Dialog Box appears.

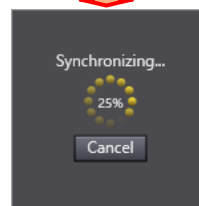

Another confirmation dialog box appears. Confirm that there is no problem and click the **No** Button.

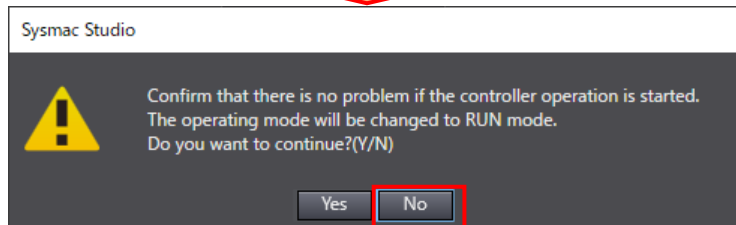

* Do not return to Run Mode yet.

14 Confirm that the synchronized data is now shown in the color of **Synchronized** and **The Synchronization process successfully finished** message is displayed. If there is no problem, click **Close**.

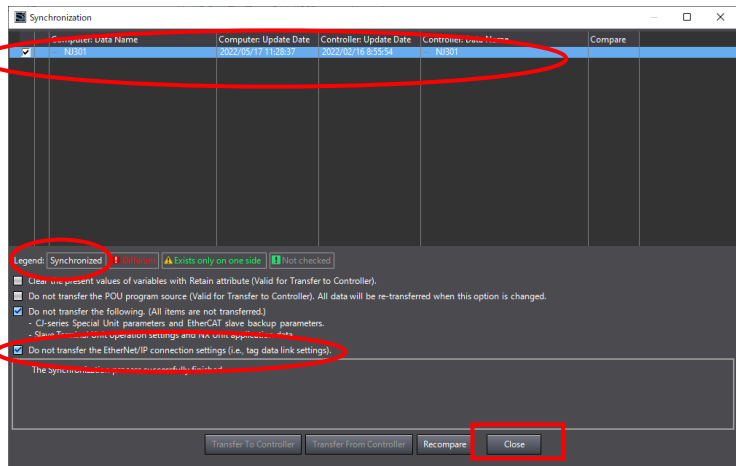

* **The Synchronization process successfully finished** message indicates that the data in the controller matches the project data in the Sysmac Studio.

* If Synchronization fails, check the physical connections and redo the procedure from step 1.

15 In **Controller Status**, confirm that the **ERR/ALM** indicator is lit green and that the mode is **PROGRAM Mode**.

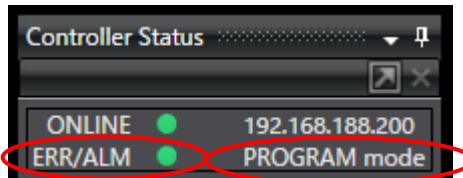

Precautions for Correct Use

If you change connection settings (in the tag data link table) after executing **Synchronize**, you will not be able to transfer the connection settings (in the tag data link table) by executing **Synchronize** again.

To transfer the connection settings in this case, click **Transfer to Controller** in the **Built-in EtherNet/IP Port Settings Connection Settings** Tab Page as shown in the right figure.

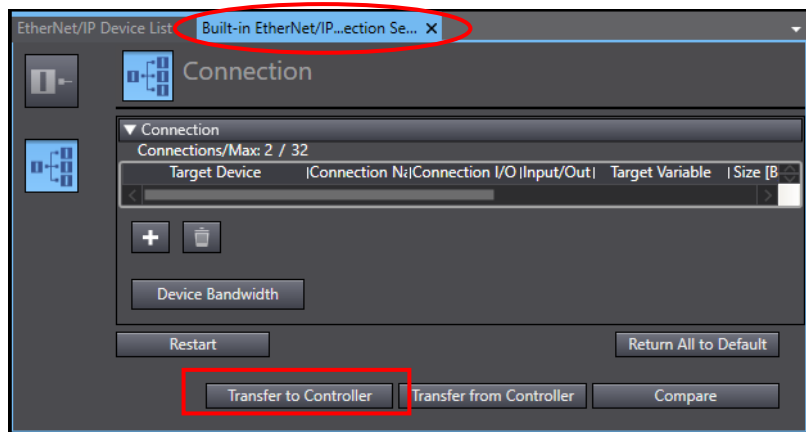

7.4. Checking the EtherNet/IP Communications

Check that the EtherNet/IP tag data links are operating normally.

7.4.1. Checking the Connection Status

Check the EtherNet/IP connection status and connect the code reader to the WebLink.

- 1 Check the LED indicators on the controller to confirm that the tag data links are operating normally.

Below is the LED status in normal operation.

NET RUN: Lit Green

NET ERR: OFF

LINK/ACT: Blinking Yellow
(Blinking while sending and receiving packets)

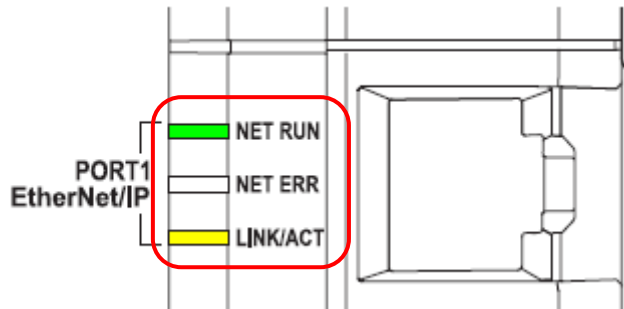

- 2 Check the LED indicators on the code reader.

For V430

Below is the LED status for V330 in normal operation.

POWER: Lit Green

Below are the LED status for V430 in normal operation.

PASS: OFF

TRIG: OFF

MODE: OFF

LINK: Lit Orange

FAIL: OFF

PWR: Lit Green

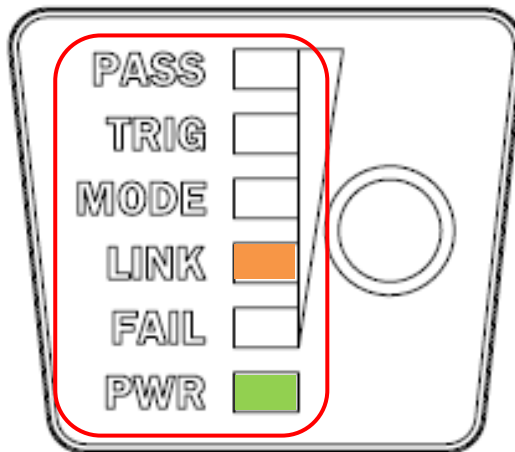

- 3 Select **EtherNet/IP Connection Settings** from the **Tools** Menu to display the **EtherNet/IP Device List** Tab Page.

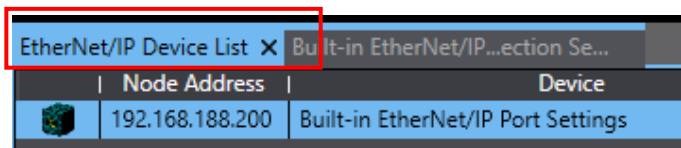

- 4 Right-click **Built-in EtherNet/IP Port Settings** and select **Monitor** from the menu.

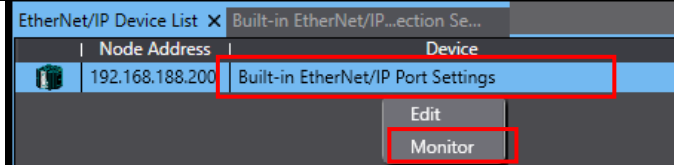

- 5 The **Built-in EtherNet/IP Port Settings Connection Monitor** Tab Page is displayed.

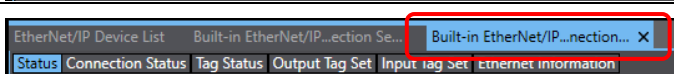

6 Select the **Connection Status** Tab Page.

Check that the connection is shown with a blue dot ● in the **Connection Name** field.

Check that **00:0000** is shown in the **Status** field.

Status	Connection Status	Tab	Status	Output Tag Set	Input Tag Set	Ethernet Information
Connection Name	Type		Status			
● 192.168.188.2 (#002)	default_001	Out/In	00:0000			

7 Select the **Tag Status** Tab Page.

Check that all tags are listed with a blue dot ● in the **Tab Name** field and shown as **Normally resolved** in the **Status** field.

Status	Connection Status	Tag Status	Output Tag Set	Input Tag Set	Ethernet Information
Tag Name	Input/Output	Status			
● EIPIInput	Input	Normally resolved			
● EIPOutput	Output	Normally resolved			

8 Start your browser and enter *http://192.168.188.2*.

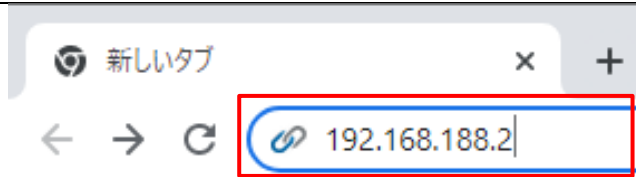

9 The WebLink screen appears.

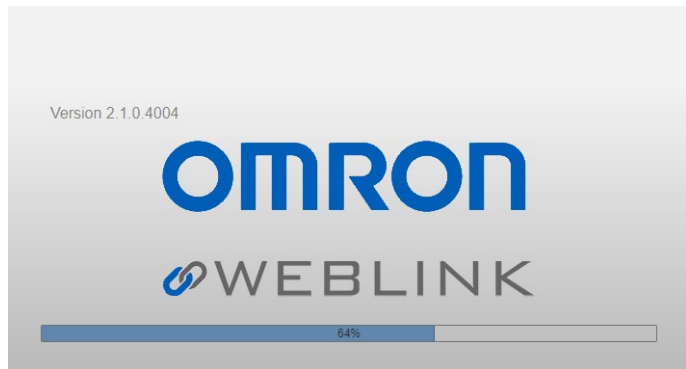

7.4.2. Checking the Sent and Received Data

Check that the correct data is sent and received.

To do so, place a readable code symbol in the code reader's field of view in advance.

Caution

If you change variable values online in the Watch Tab Page, the devices connected to Output Units may operate regardless of the operating mode of the CPU Unit.

Sufficiently confirm safety before you change the values of variables on a Watch Tab Page when the Sysmac Studio is online with the CPU Unit.

- 1** This document uses the 2D code shown in the right figure as an example of reading.
Set the code reader to the position where it can read the 2D code in the right figure.
- 2** Select **Watch Tab Page** from the **View** Menu.
- 3** Select **Watch Tab Page 1**.
- 4** Click on **Input Name** and enter the **Name** of the variable to monitor.
To set a new variable name, enter the following variable name.
EIPOutput.COMMANDS.Trigger
EIPInput

5 For EIPOutput.COMMANDS.Trigger, change the value in the **Modify** field to **TRUE**.

* It is required that EIPOutput.COMMANDS.Online is **TRUE**.

Press the **Enter** Key and confirm that **Online value** for EIPOutput.COMMANDS.Trigger is **True**.

Name	Online value	Modify	Data type	Display format
EIPOutput.COMMANDS.Trigger	False	TRUE	BOOL	Boolean
EIPInput			S_EIPInput103	

Name	Online value	Modify	Data type	Display format
EIPOutput.COMMANDS.Trigger	True	FALSE	BOOL	Boolean
EIPInput			S_EIPInput103	

6 The Read processing completes and the result is reflected on the WebLink screen.

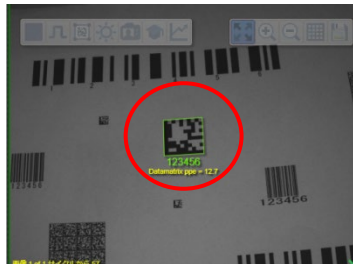

7 EIPInput.DECODE_LENGTH and EIPInput.DECODE_DATA will display the following for this example string.

```
<Decoded String: 123456>
EIPInput.DECODE_LENGTH: 6
EIPInput.DECODE_DATA[0]: 31(1)
EIPInput.DECODE_DATA[1]: 32(2)
EIPInput.DECODE_DATA[2]: 33(3)
EIPInput.DECODE_DATA[3]: 34(4)
EIPInput.DECODE_DATA[4]: 35(5)
EIPInput.DECODE_DATA[5]: 36(6)
```

DECODE_DATA should be set to output in ASCII.

Name	Online value	Modify	Display format
EIPInput			
INFO_BITS	1		Decimal
RESERVED_1	0		Decimal
CONFIGURATION_CHANGE	0		Decimal
RESERVED_2	00		Hexadecim
▶ DEVICE_STATUS			
FAULT_CODE	0		Decimal
▶ COUNTERS[0-5]			
▶ READ_CYCLE_REPORT[0-3]			
▶ DECODE_CYCLE_REPORT[0-3]			
CODE_TYPE	2048		Decimal
PIXELS_PER_ELEMENT	22.1		Real
DECODE_LENGTH	6		Decimal
▼ DECODE_DATA[0-435]			
DECODE_DATA[0]	31		Hexadecim
DECODE_DATA[1]	32		Hexadecim
DECODE_DATA[2]	33		Hexadecim
DECODE_DATA[3]	34		Hexadecim
DECODE_DATA[4]	35		Hexadecim
DECODE_DATA[5]	36		Hexadecim
DECODE_DATA[6]	00		Hexadecim

8 Change the display format to **ASCII** and check DECODE_DATA.

▼ DECODE_DATA[0-435]			
DECODE_DATA[0]	1 (16#31)		ASCII
DECODE_DATA[1]	2 (16#32)		ASCII
DECODE_DATA[2]	3 (16#33)		ASCII
DECODE_DATA[3]	4 (16#34)		ASCII
DECODE_DATA[4]	5 (16#35)		ASCII
DECODE_DATA[5]	6 (16#36)		ASCII
DECODE_DATA[6]	. (16#00)		ASCII

8. Initializing the System

In this document, it is assumed that the controller and the code reader uses the factory default settings.

If you change their settings from the default, you may not be able to perform various setting procedures as described.

8.1. Initializing the Controller

To initialize the controller, initialize the CPU Unit.

Before initialization, place the controller in PROGRAM Mode, and select **Clear All Memory** from **Controller** Menu in the Sysmac Studio. When the **Clear All Memory** Dialog Box is displayed, confirm the contents and click **OK**.

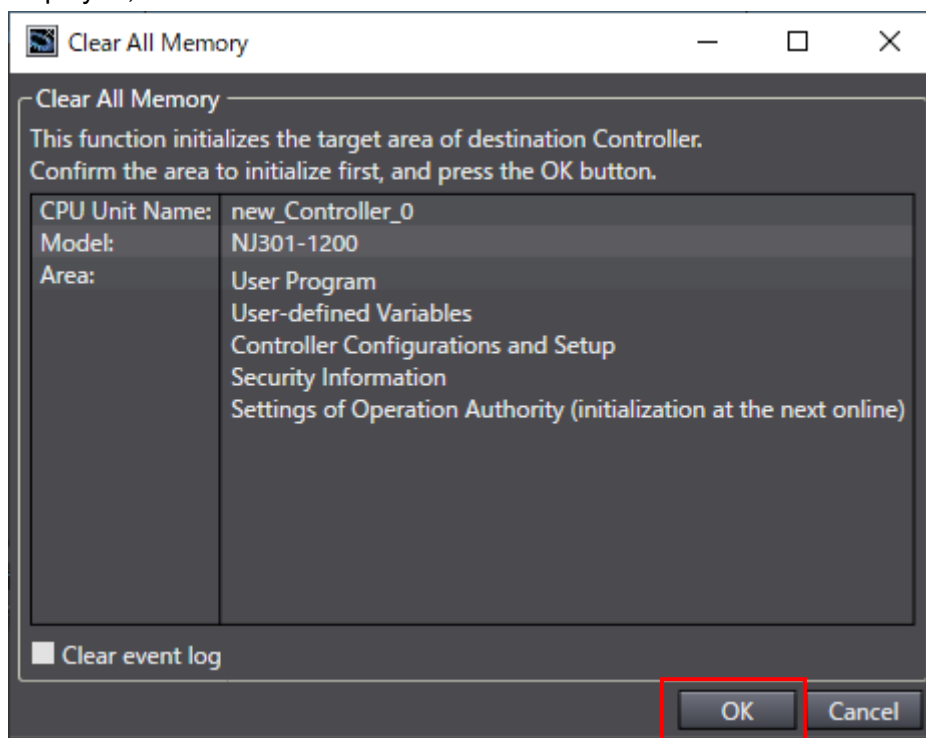

8.2. Initializing the Code Reader

For information on initializing the code reader, please refer to *How to initialize the settings?* in Q&A in Appendices of the *MicroHAWK V320-F/V330-F/V420-F/V430-F Series Barcode Reader User Manual* (Cat. No. Z432).

9. Appendices How to Use the Project File

This section explains the procedure for using the following project file. The project file contains the settings described in 7.3. *Controller Setup*.

Obtain the latest version of the project file from OMRON Corporation.

Name	Filename	Version
Sysmac Studio Compact Project File (Extension: csm2)	OMRON_V330_NJ_EIP_V100.csm2	Ver. 1.00
Sysmac Studio Compact Project File (Extension: csm2)	OMRON_V430_NJ_EIP_V101.csm2	Ver. 1.00

9.1. Operation Flow

The procedures for setting up the EtherNet/IP tag data links using the project file are as follows.

Refer to the respective sections, except for 9.2.1. *Loading the Project File* shown in the red frame.

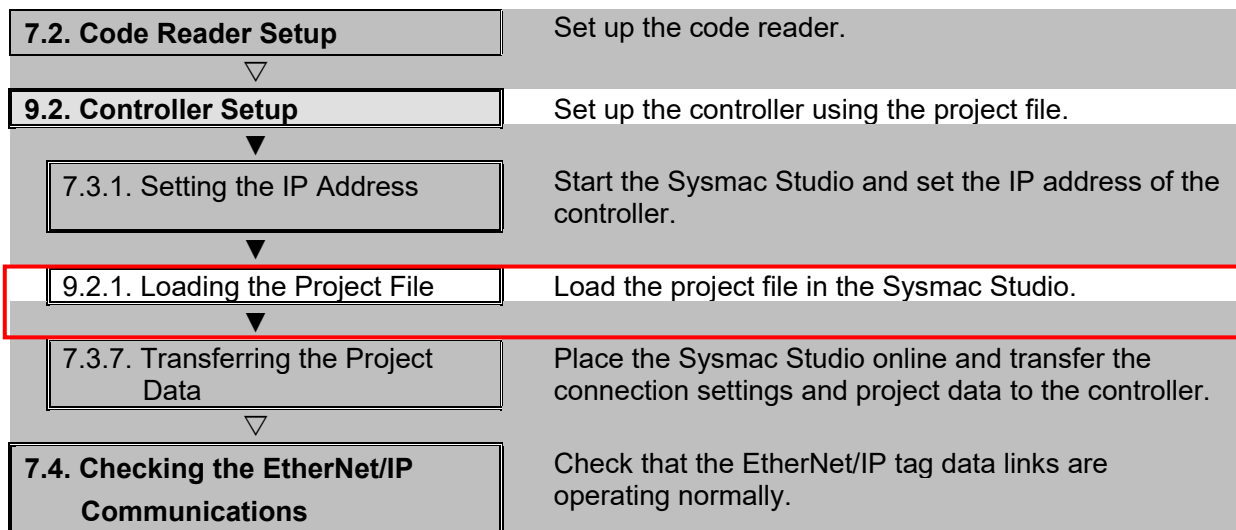

9.2. Controller Setup

Set up the controller using the project file.

9.2.1. Loading the Project File

Load the project file in the Sysmac Studio.

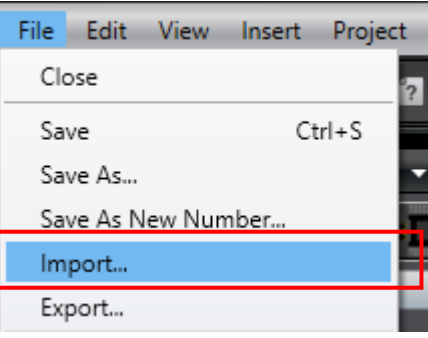
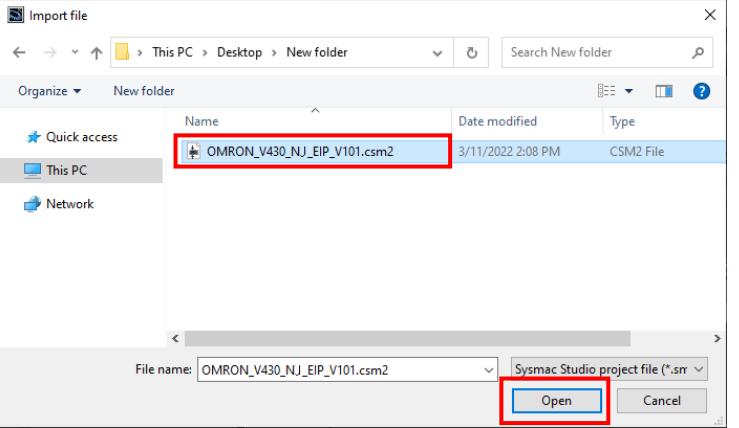
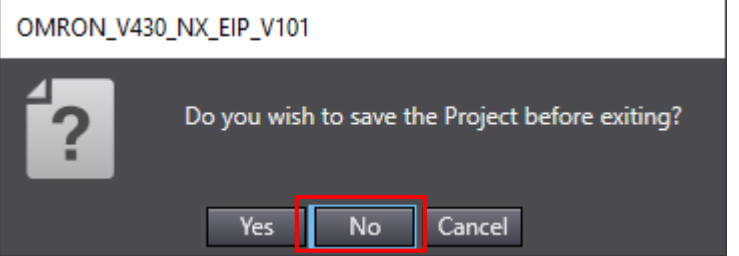
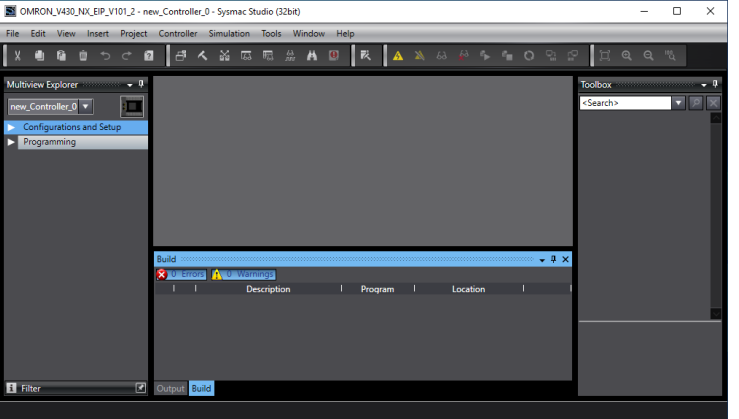
<p>1 Select Import from the File Menu.</p>	
<p>2 The Import file Dialog Box is displayed. Select the project file OMRON_V330_NJ_EIP_V100.csm2 or OMRON_V430_NJ_EIP_V101.csm2 and click Open.</p> <p>* Obtain the latest version of the project file from the OMRON website.</p>	
<p>3 The New Project Dialog Box is displayed. Confirm the information and click No.</p>	
<p>4 The Project Screen is displayed.</p> <p>* If the error message <i>Cannot compare the repositories, the version on the target different from the source.</i> is displayed, change the Sysmac Studio version to the version indicated in 5.2. <i>Device Configuration</i> or higher.</p>	

- 5** Select **Change Device** from the **Controller** Menu.

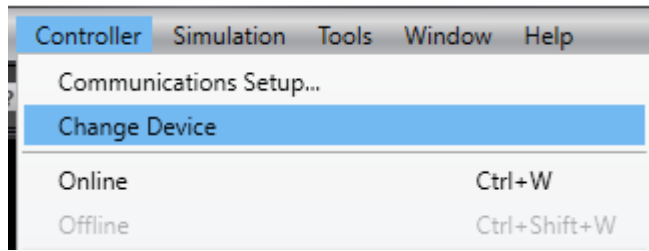

- 6** The **Change Device** Dialog Box is displayed.

Confirm that the **Device** and **Version** settings for the device are as shown in the figure on the right.

Click **Cancel**.

* If using a different device, select the device and version from the pull-down menus and click **OK**.

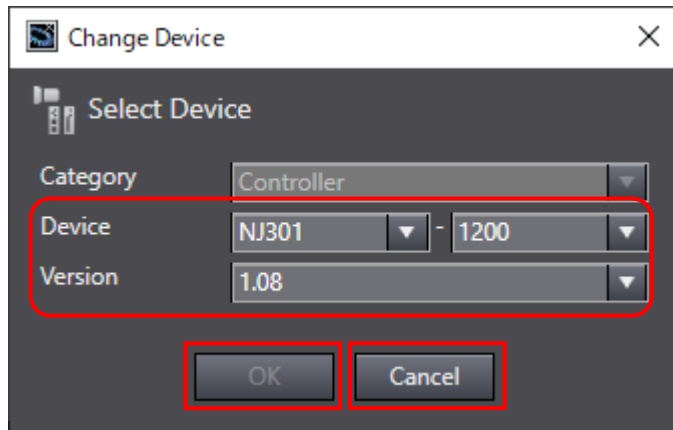

10. Revision History

Revision Code	Revision Date	Revised Page and Reason
01	July 2022	First Publication
02	February 2023	Corrected mistakes

OMRON Corporation Industrial Automation Company

Kyoto, JAPAN

Contact : www.ia.omron.com

Regional Headquarters

OMRON EUROPE B.V.

Wegalaan 67-69, 2132 JD Hoofddorp
The Netherlands
Tel: (31) 2356-81-300 Fax: (31) 2356-81-388

OMRON ASIA PACIFIC PTE. LTD.

438B Alexandra Road, #08-01/02 Alexandra
Technopark, Singapore 119968
Tel: (65) 6835-3011 Fax: (65) 6835-2711

OMRON ELECTRONICS LLC

2895 Greenspoint Parkway, Suite 200
Hoffman Estates, IL 60169 U.S.A.
Tel: (1) 847-843-7900 Fax: (1) 847-843-7787

OMRON (CHINA) CO., LTD.

Room 2211, Bank of China Tower,
200 Yin Cheng Zhong Road,
PuDong New Area, Shanghai, 200120, China
Tel: (86) 21-5037-2222 Fax: (86) 21-5037-2200

Authorized Distributor:

©OMRON Corporation 2022-2023 All Rights Reserved.
In the interest of product improvement,
specifications are subject to change without notice.

Cat. No. Z411-E1-02 0223