



Machine Automation Controller NX-series

Serial (RS-232C) Communications Connection Guide

OMRON Corporation Auto Focus Multi Code Reader V320-F / V420-F / V430-F-series

Network
Connection
Guide

About Copyrights and Trademarks

Microsoft product screen shots used with permission from Microsoft.

Windows is a registered trademark of Microsoft Corporation in the USA and other countries.

Sysmac and SYSMAC are trademarks or registered trademarks of OMRON Corporation in Japan and other countries for OMRON factory automation products.

Company names and product names in this document are the trademarks or registered trademarks of their respective companies.

Contents

1. Related Manuals	1
2. Restrictions and Precautions	2
3. Overview	3
4. Applicable Products and Support Tools	4
4.1. Applicable Products	4
4.2. Device Configuration	5
5. Serial Communications Settings	10
5.1. Serial Communications Settings	10
5.2. Cable Wiring Diagram	11
5.3. Example of Connection Check for Communications.....	12
6. Connection Procedure	13
6.1. Operation Flow	13
6.2. Code Reader Setup	14
6.3. Controller Setup.....	19
6.4. Checking That Serial Communications Work.....	30
Appendix 1. Initializing the System	35
A1.1. Initializing the Controller	35
A1.2. Initializing the Code Reader	36
Appendix 2. Ladder Program	37
A2.1. Overview.....	37
A2.2. Program in Ladder Language	40
A2.3. Variables Used	41
Revision History	43

1. Related Manuals

To ensure system safety, make sure to always read and follow the information provided in all Safety Precautions and Precautions for Safe Use in the manuals for each device which is used in the system.

The following OMRON Corporation (hereinafter referred to as “OMRON”) manuals are related to this document:

Cat. No.	Model	Manual name
W535	NX Series	NX-series NX701 CPU Unit Hardware User's Manual
W593	NX Series	NX-series NX102 CPU Unit Hardware User's Manual
W578	NX Series	NX-series NX1P2 CPU Unit Hardware User's Manual
W501	NJ/NX Series	NJ/NX-series CPU Unit Software User's Manual
W540	NX Series	NX-series Communications Interface Unit User's Manual
W504	SYSMAC-SE2□□□	Sysmac Studio Version 1 Operation Manual
W502	NJ/NX Series	Machine Automation Controller Instructions Reference Manual
Z432	V320-F/V330-F/V420-F/V430-F Series	MicroHAWK V320-F/V330-F/V420-F/V430-F Series Barcode Reader User Manual
Z407	V320-F/V330-F/V420-F/V430-F Series	Autofocus Multicode Reader MicroHAWK V320-F/V330-F/V420-F/V430-F Series User Manual for Communication Settings

2. Restrictions and Precautions

- (1) Before building a system, understand the specifications of devices which are used in the system. Allow some margin for ratings and performance, and provide safety measures such as installing a safety circuit in order to minimize the risk in case of failure.
- (2) To ensure system safety, make sure to read and follow the information provided in all *Safety Precautions* and *Precautions for Safe Use* in the manuals for each device which is used in the system.
- (3) The user is encouraged to confirm the standards and regulations that the system must conform to.
- (4) It is prohibited to copy, to reproduce, and to distribute a part or the whole of this document without the permission of OMRON Corporation.
- (5) The information contained in this document is current as of April 2023.
It is subject to change for improvement without notice.

The following notations are used in this document.

 WARNING	Indicates a potentially hazardous situation which, if not avoided, may result in minor or moderate injury, or may result in serious injury or death. Additionally, there may be severe property damage.
---	---

 Caution	Indicates a potentially hazardous situation which, if not avoided, may result in minor or moderate injury, or property damage.
--	--



Precautions for Safe Use

Precautions on what to do and what not to do to ensure safe usage of the product.



Precautions for Correct Use

Precautions on what to do and what not to do to ensure proper operation and performance.



Note

Additional information to read as required.

This information is provided to increase understanding or make operation easier.

Symbols



The filled circle symbol indicates operations that you must do.

The specific operation is shown in the circle and explained in text.

This example shows a general precaution for something that you must do.

3. Overview

This document describes the procedures for connecting the OMRON code reader products (V320-F/V420-F/V430-F) to an NX Series Machine Automation Controller with a Serial Communications Unit (hereinafter referred to as “controller”) via serial communications and for checking their connections.

Refer to *Section 5. Serial Communication Settings* and *Section 6. Connection Procedure* to understand the setting procedures and key points of setup to establish a serial communications connection.

Obtain the latest version of the Sysmac Studio Project File in advance before proceeding. Contact OMRON for information on how to obtain this file.

Name	Filename	Version
Sysmac Studio Project File (Extension: smc2)	OMRON_V320_V420_V430_NX_RXD_V100.smc2	Ver. 1.00

Caution

The purpose of this document is to describe the wiring methods, communication settings, and setting procedures required to establish a connection for communications with applicable devices. In addition, the program used in this document is designed to check that the connection has been correctly performed (connection check). Since the program is not intended for permanent use on-site, full consideration is not given to functionality and performance. When configuring an actual system, please refer to the wiring methods, communication settings, and setting procedures described in this document to design and create a program that meets your purpose.



4. Applicable Products and Support Tools

4.1. Applicable Products

The applicable devices that are required to ensure a connection are as follows:

Manufacturer	Name	Model	Version
OMRON	NX Series CPU Unit	NX701-□□□□ NX102-□□□□ NX1P2-□□□□	Same or later version as indicated in section 4.2.
OMRON	Serial Communications Unit	NX-CIF210	
OMRON	Code reader	V320-F□□□□□□□-□□□ V420-F□□□□□□□-□□□ V430-F□□□□□□□-□□□	



Note

From among the above applicable devices, this document uses the devices listed in section 4.2 for the connection check. When using devices that are not described in section 4.2, check the connection according to this document.



Note

This document describes the procedures for establishing the communication connection of the device, and does not describe the operation, installation and wiring method of the device.

For details on the above products (other than communication connection procedures), please refer to the instruction manual for the product or contact OMRON.



Precautions for Correct Use

The connection and connection check procedures described in this document use the devices listed in section 4.2, from among the above applicable devices.

You cannot use devices with versions earlier than the versions listed in section 4.2.

To use models that are not listed in section 4.2. or versions that are later than those listed in section 4.2., check the differences in the specifications according to their instruction manuals before operating the devices.

4.2. Device Configuration

The system components required for reproducing the connection procedures described in this document are as follows.

- Configuration with V320-F

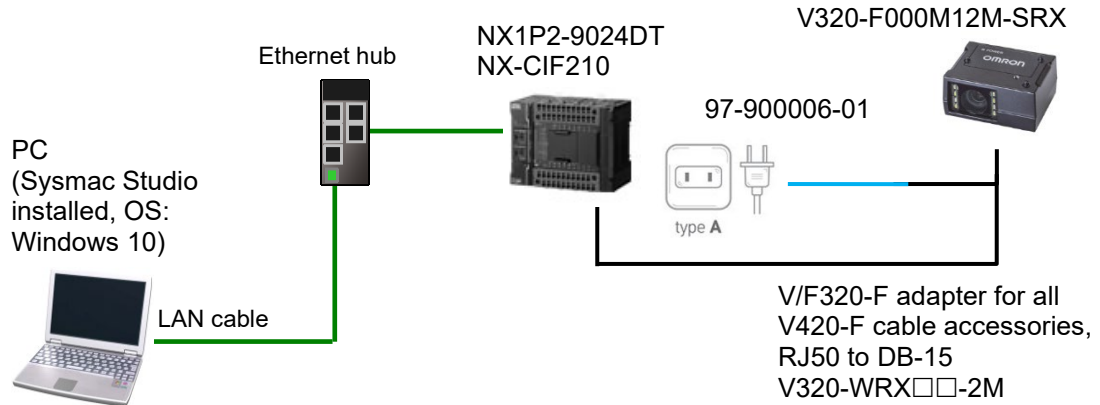

Manufacturer	Name	Model	Version
OMRON	NX Series CPU Unit (Built-in EtherNet/IP Port)	NX1P2-9024DT	Ver. 1.19
OMRON	Serial Communications Unit	NX-CIF210	Ver. 2.1
OMRON	Sysmac Studio	SYSMAC-SE2□□□	Ver. 1.28
OMRON	Sysmac Studio Project File	OMRON_V320_V420_V430_NX_RXD_V100.smc2	Ver. 1.00
---	PC (OS: Windows 10)	---	---
---	LAN cable	---	---
OMRON	Code reader	V320-F000M12M-SRX	Ver. 2.1.0
OMRON	V/F320-F adapter for all V420-F cable accessories, RJ50 to DB-15	V320-WRX□□-2M	---
OMRON	Power supply	97-900006-01	---
---	AC power supply	---	---

4. Applicable Products and Support Tools

WebLink cannot be used for RS-232C connection.

To use WebLink, the following system components for USB connection are required.

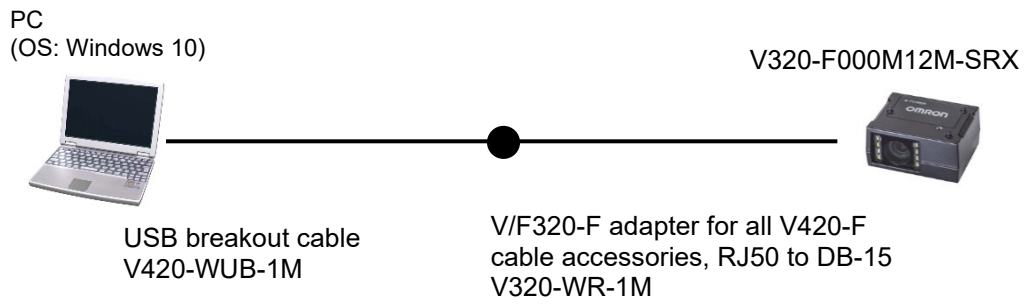

Manufacturer	Name	Model	Version
---	PC (OS: Windows 10)	---	---
OMRON	Code reader	V320-F000M12M-SRX	Ver. 2.1.0
OMRON	V/F320-F adapter for all V420-F cable accessories, RJ50 to DB-15	V320-WR-1M	---
OMRON	USB breakout cable	V420-WUB-1M	---

- Configuration with V420-F

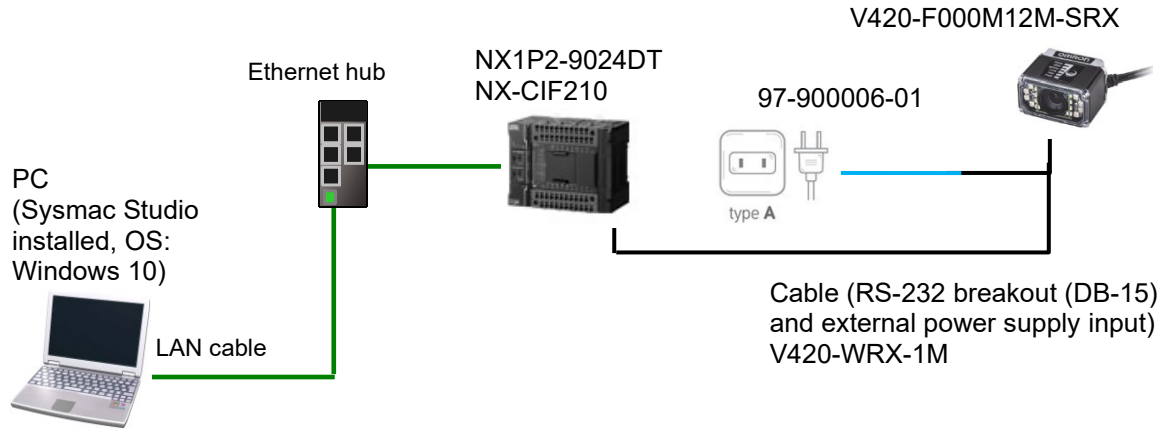

Manufacturer	Name	Model	Version
OMRON	NX Series CPU Unit (Built-in EtherNet/IP Port)	NX1P2-9024DT	Ver. 1.19
OMRON	Serial Communications Unit	NX-CIF210	Ver. 2.1
OMRON	Sysmac Studio	SYSMAC-SE2□□□	Ver. 1.28
OMRON	Sysmac Studio Project File	OMRON_V320_V420_V430_ NX_RXD_V100.smc2	Ver. 1.00
---	PC (OS: Windows 10)	---	---
---	LAN cable	---	---
OMRON	Code reader	V420-F000M12M-SRX	Ver. 2.1.0
OMRON	Cable (RS-232 breakout (DB-15) and external power supply input)	V420-WRX-1M	---
OMRON	Power supply	97-900006-01	---
---	AC power supply	---	---

WebLink cannot be used for RS-232C connection.

To use WebLink, the following system components for USB connection are required.

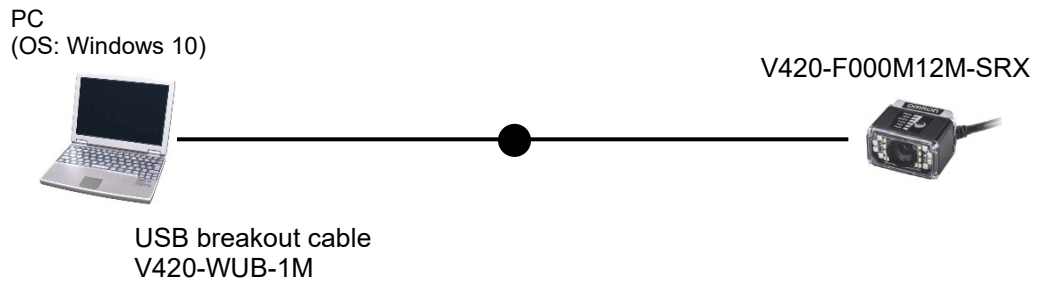

Manufacturer	Name	Model	Version
---	PC (OS: Windows 10)	---	---
OMRON	Code reader	V420-F000M12M-SRX	Ver. 2.1.0
OMRON	USB breakout cable	V420-WUB-1M	---

- Configuration with V430-F

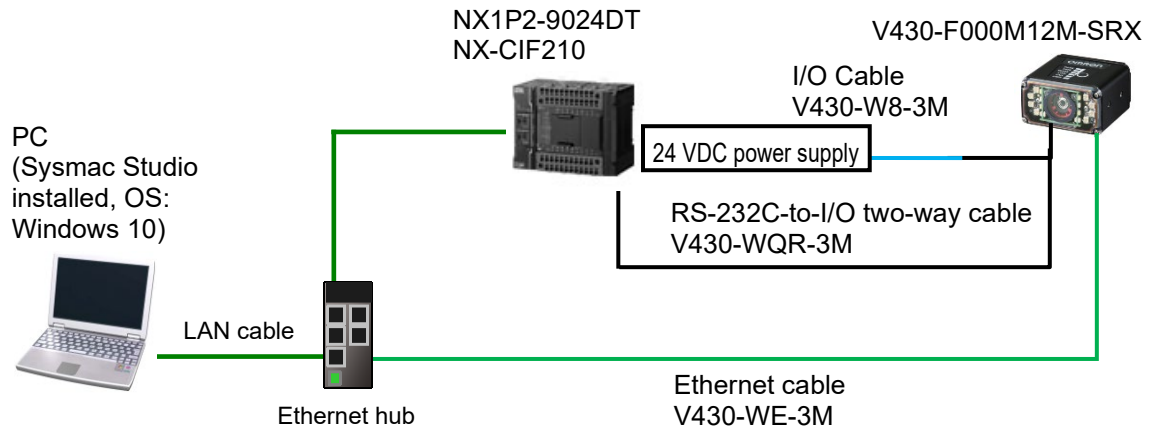

Manufacturer	Name	Model	Version
OMRON	NX Series CPU Unit (Built-in EtherNet/IP Port)	NX1P2-9024DT	Ver. 1.19
OMRON	Serial Communications Unit	NX-CIF210	Ver. 2.1
OMRON	Sysmac Studio	SYSMAC-SE2□□□	Ver. 1.28
OMRON	Sysmac Studio Project File	OMRON_V320_V420_V430_ NX_RXD_V100.smc2	Ver. 1.00
---	PC (OS: Windows 10)	---	---
---	LAN cable	---	---
OMRON	Code reader	V430-F000M12M-SRX	Ver. 2.1.0
OMRON	RS-232C-to-I/O two-way cable	V430-WQR-3M	---
OMRON	I/O Cable	V430-W8-3M	---
OMRON	Ethernet Cable*1	V430-WE-3M	---
---	24 VDC power supply	---	---

*1: The Ethernet cable is used for WebLink connection.



Precautions for Correct Use

Obtain the latest version of the Sysmac Studio Project File from OMRON in advance.
(Contact OMRON for information on how to obtain this file.)



Precautions for Correct Use

Ensure that the Sysmac Studio and CX-Protocol are updated to the versions specified in this section or higher. If you use versions other than the versions specified in this section, there may be differences in the procedures in Section 7 and later. In that case, refer to the *Sysmac Studio Version 1 Operation Manual* (Cat. No. W504) or *CX-Protocol Operation Manual* (Cat. No. W344) to perform the equivalent procedures.

5. Serial Communications Settings

This section shows the specifications of the communication parameter settings, cable wiring, and other information provided in this document.



Note

You need to modify the program to use communication settings that are not described in this section. For more information on the program, please refer to *Appendix 2. Ladder Program*.

5.1. Serial Communications Settings

The serial communications settings are as follows.

Parameter name	Serial Communications Unit	Code reader
Unit number	1	---
Communications (connection) port	Port 2 (RS-232C)	---
Serial communications mode	No-protocol	---
Data bit length	8 bits	8 bits (default)
Stop bit	1 bit	1 bit (default)
Parity	None	None (default)
Baud rate	115,200 bps	115,200 bps (default)
Header	---	None (default)
Footer	---	<CR+LF> (default)
Host port protocol	---	Point-to-point (default)



Precautions for Correct Use

It is assumed that the NX-CIF210 Serial Communications Unit is used with the unit number 0 and the communications (connection) port *Port 2*. If using other conditions to connect the Unit, refer to *Appendix 2. Ladder Program* and create a program by modifying the control data in the CIO Area and PMCR Instruction.

5.2. Cable Wiring Diagram

For details on cable wiring, refer to *Section 4 Installation and Wiring* in the *NX-series Communications Interface Units User’s Manual* (Cat. No. W540).

Check the connector shape and signal lines (pin assignment) before you prepare the cable.

■ Connector Shape and Signal Lines (Pin Assignment)

Applicable connector for serial ports on NX-CIF210: D-sub 9-pin

Arrangement of D-sub Connector Pins on NX-CIF210

The arrangement of the D-sub connector pins on the NX-CIF210 are given in the following table.

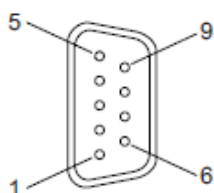

Pin No.	Abbrev.	Signal name	I/O
1	---	Not used.	---
2	RD	Receive data	Input
3	SD	Send data	Output
4	ER	Data terminal ready	Output
5	SG	Signal ground	---
6	DR	Data set ready	Input
7	RS	Request to send	Output
8	CS	Clear to send	Input
9	---	Not used.	---
Shell	SHLD	Shield	---

Applicable connector for V Series RS-232C cable: D-SUB 9-pin (Connector on V Series side: Female)

Pin No.	Signal name	Pin assignment
1	-	
2	SD	
3	RD	
4	-	
5	0V	
6	-	
7	-	
8	-	
9	-	

5.3. Example of Connection Check for Communications

This document assumes that you use a “ladder program” to check the connection for communications. For details on the ladder program, please refer to *Appendix 2. Ladder Program*.

The “Read code” message is sent and received between the NX Series CPU Unit and the code reader. An overview of the operation is shown below.

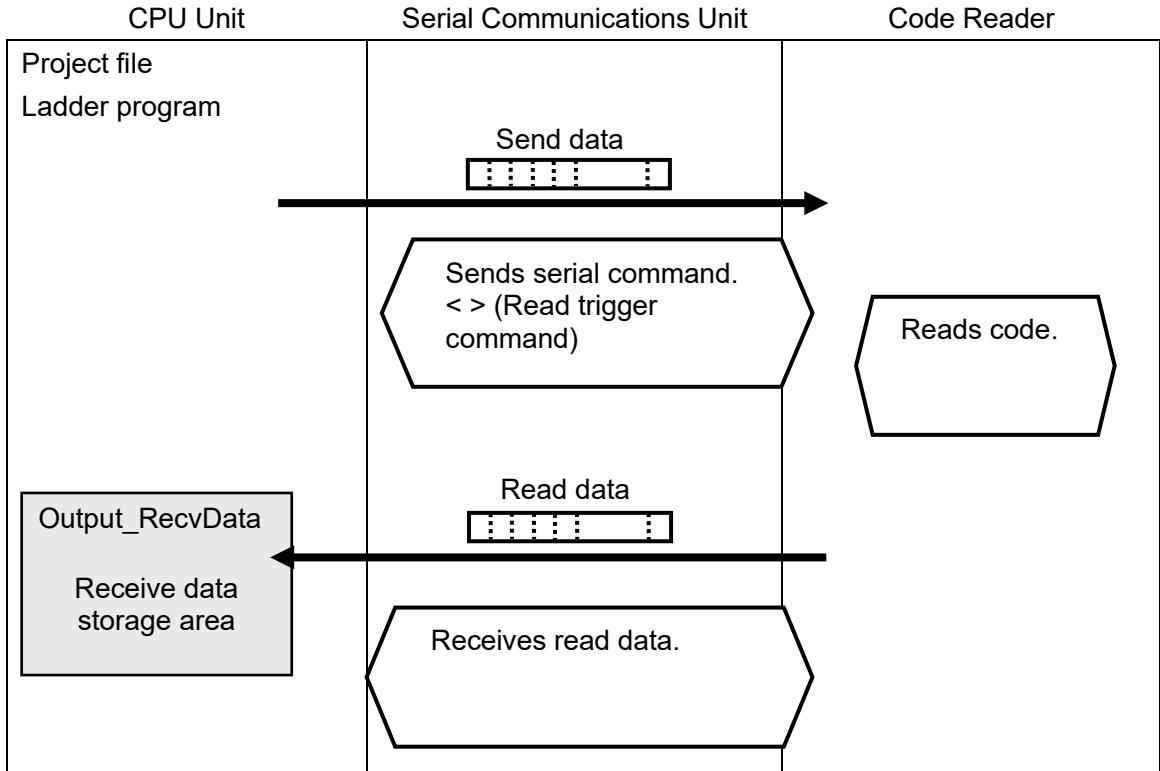

6. Connection Procedure

This section describes the procedures for connecting the code reader to the controller for serial communications.

In this document, it is assumed that the controller and the code reader use the factory default settings. For how to initialize the devices, refer to *Appendix 1. Initializing the System*.

6.1. Operation Flow

Use the following procedures to set up the controller for serial communications connection.

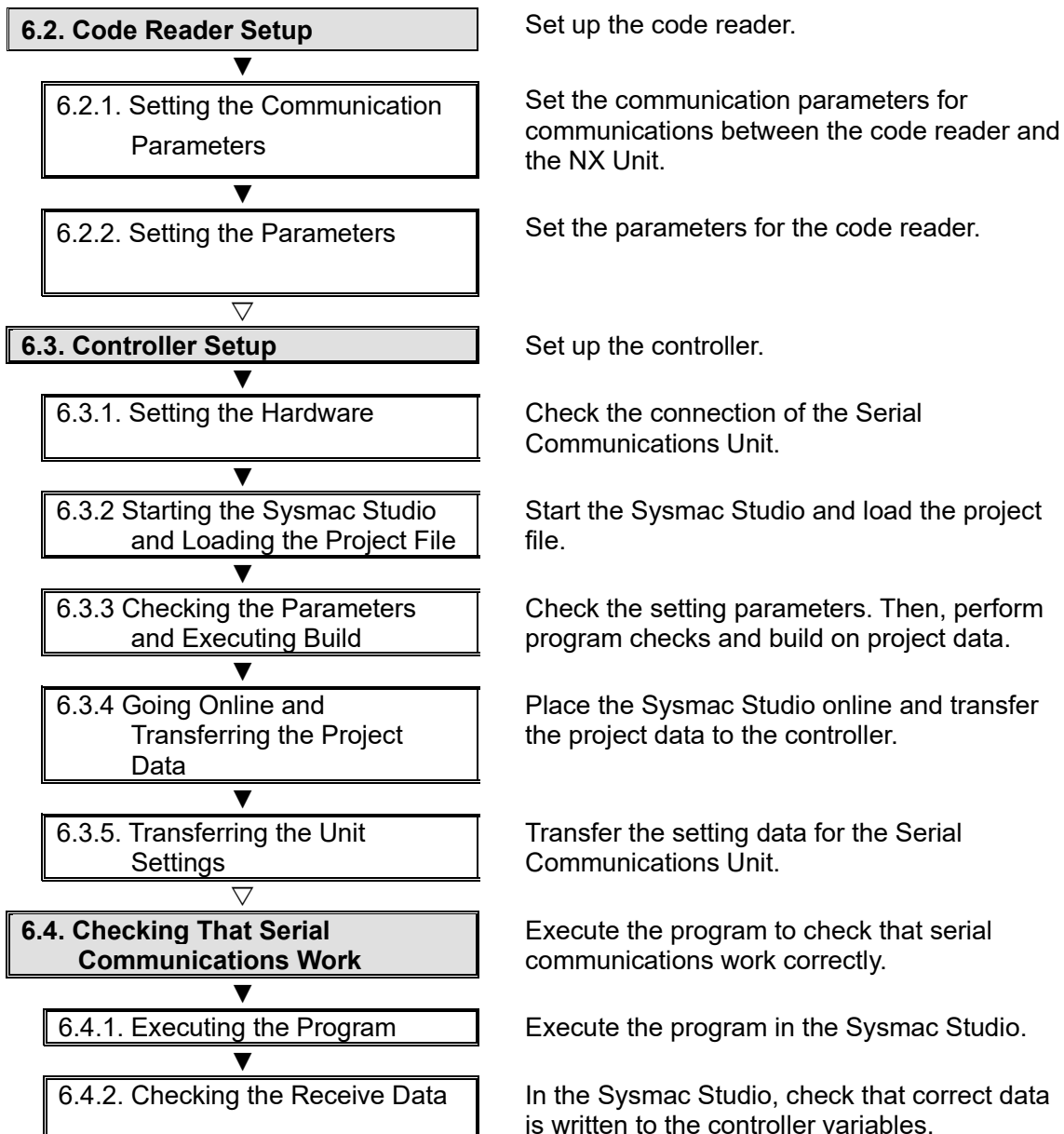

6.2. Code Reader Setup

Set up the code reader.

6.2.1. Setting the Communication Parameters

Set the parameters for the code reader.

Set the IP address of your PC to *192.168.188.100* and its subnet mask to *255.255.0.0*.

1 [Using V320-F/V420-F]

Establish a USB connection between the V320/V420 and the PC according to the configuration shown on page 6 or page 8. Once the connection is established, start the procedure from step 7.

* To connect the V320/V420 to WebLink, you need to install a driver. For how to install the driver, refer to 2-2-3 *Connect to WebLink* in the *MicroHAWK V320-F/V330-F/V420-F/V430-F Series Barcode Reader User Manual* (Cat. No. Z432).

[Using V430-F]

Connect the RS-232C-to-I/O two-way cable V430-W2-3M to the I/O connector. Then, connect the I/O connector of V430-W2-3M to the I/O cable V430-W8-3M.

Connect the 24V and 0V wires of W430-W8-3M to a 24 VDC power supply.

* In this document, only the power supply wires of the I/O cable are connected and checked. Be careful not to short-circuit any other wires.

* Ground the shield wire as needed. For more information on grounding, please refer to *Grounding* in *Appendices* of the *MicroHAWK V320-F/V330-F/V420-F/V430-F Series Barcode Reader User Manual* (Cat. No. Z432).

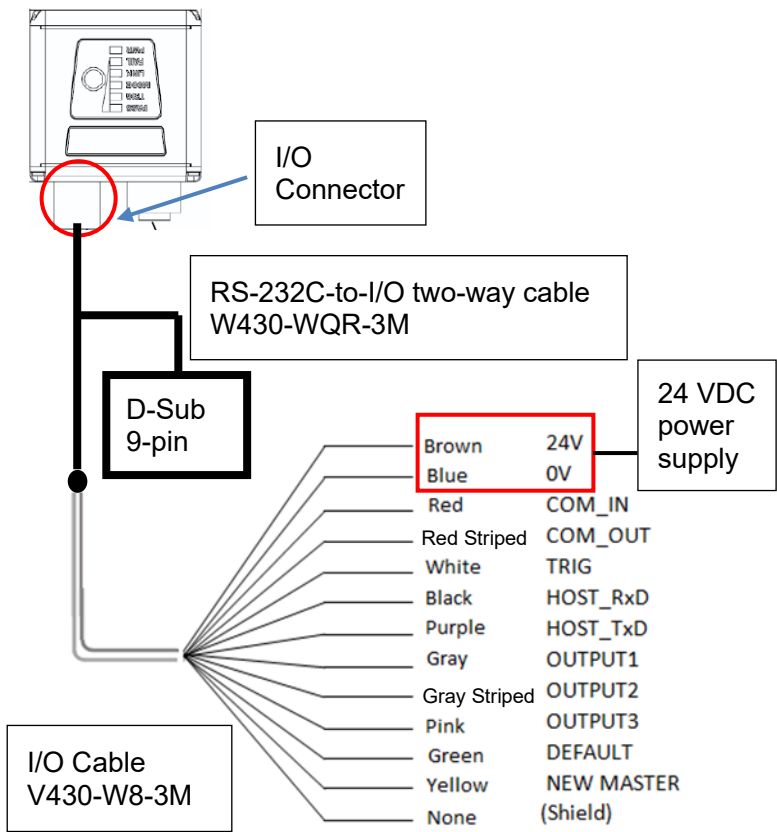

2 [V430-F Series Only]

Connect the Ethernet connector on the code reader to the PC using the Ethernet cable V430-WE-3M.

Turn ON the 24 VDC power supply.

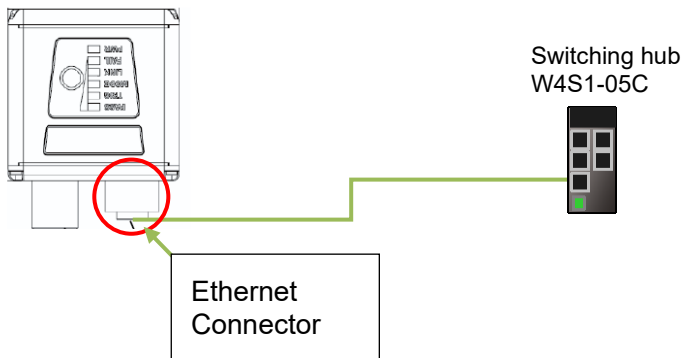

3 Connect the PC to the switching hub with a LAN cable.

Connect 24 VDC power supply (for the switching hub) to the switching hub.

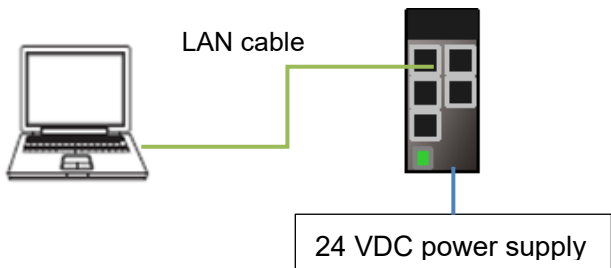

4 Set the IP Address of the PC.

For the IP address, enter *192.168.188.100*. For the subnet mask, enter *255.255.0.0*.

For the procedure to open the screen on the right, please refer to the next step 5.

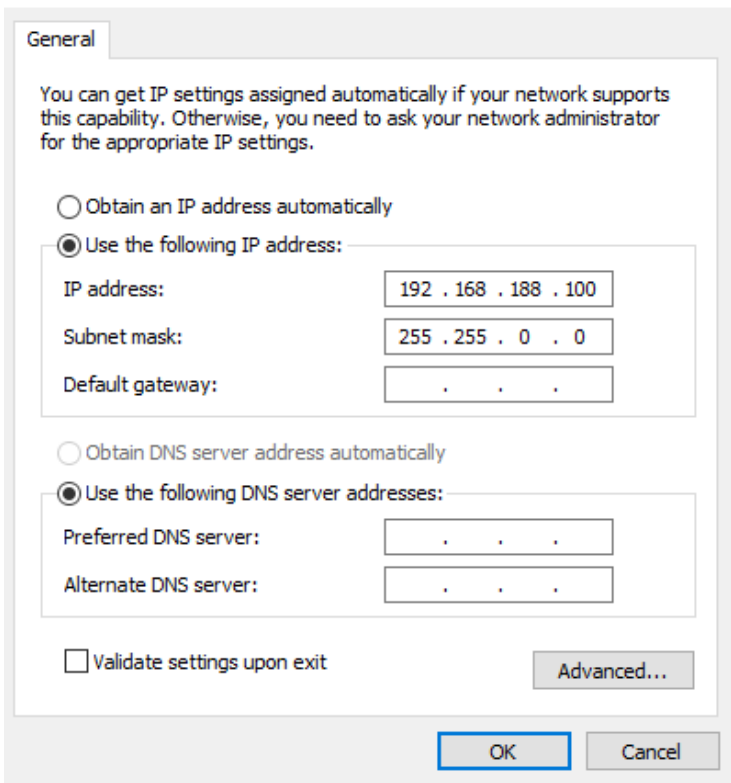

5 Static connection (Setting the fixed IP address)

• Using Windows 10

- (1) From the Windows **Start Menu**, select **Windows Settings – Network & Internet**.
- (2) Under **Change your network settings**, click **Change adapter options**.
- (3) In **Network Connections**, right-click on the **Ethernet** icon and select **Properties**.
- (4) In the **Ethernet Properties** Dialog Box, select **Internet Protocol Version 4 (TCP / IPv4)**, and click the **Properties** Button. Set the IP Address of the PC to *192.168.188.100*.
- (5) Click the **OK** Button.

• Using Windows 7

- (1) From the Windows **Start Menu**, select **Control Panel – Network and Internet – Network and Sharing Center**.
- (2) Click on **Local Area Connection**. The **Local Area Connection Status** Dialog Box is displayed. Click **Properties**.
- (3) In the **Local Area Connection Properties** Dialog Box, select **Internet Protocol Version 4 (TCP/IPv4)**, and click the **Properties** Button. Set the IP Address of the PC to *192.168.188.100*.
- (4) Click the **OK** Button.

- 6** Start your browser and enter *http://192.168.188.2*.
“Google Chrome” is the recommended browser.

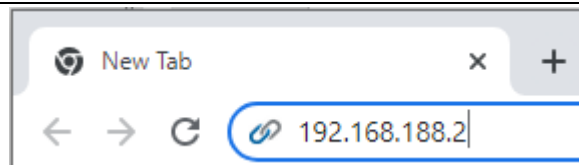

- 7** When the WebLink startup screen is displayed, go to step 9.

If you cannot access by WebLink, go to step 8.

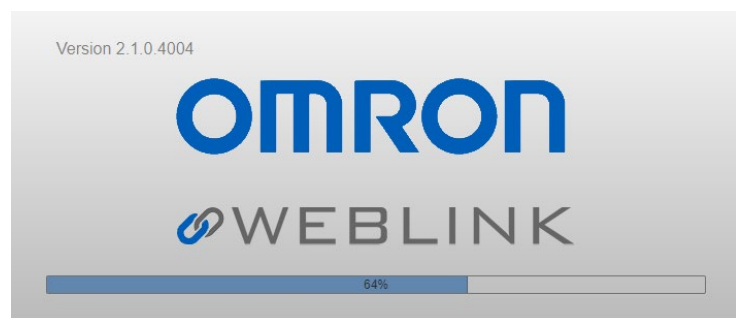

- 8** If the WebLink startup screen does not appear, it means that communications are not established between the code reader and the PC. Please check the following.

- The code reader and the PC have a proper physical (cable) connection.
→ Refer to steps 1 and 2 for checking the connection.
- The IP Addresses of the PC and code reader are set correctly.
→ Refer to step 4 for setting the IP address of the PC.

For other measures that can be taken, please refer to *When unable to access by WebLink* in Q&A in Appendices of the *MicroHAWK V320-F/V330-F/V420-F/V430-F Series Barcode Reader User Manual* (Cat. No. Z432).

9 The WebLink screen appears.

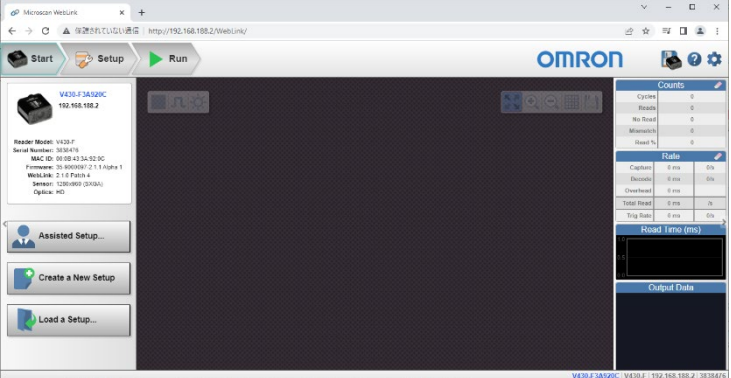

10 Click on the **Setup** Tab and, in **Read Cycle Sequence**, set **Cycle** to *Triggered*.



11 Click on the gear icon on the upper right of the screen and select **Advanced**.

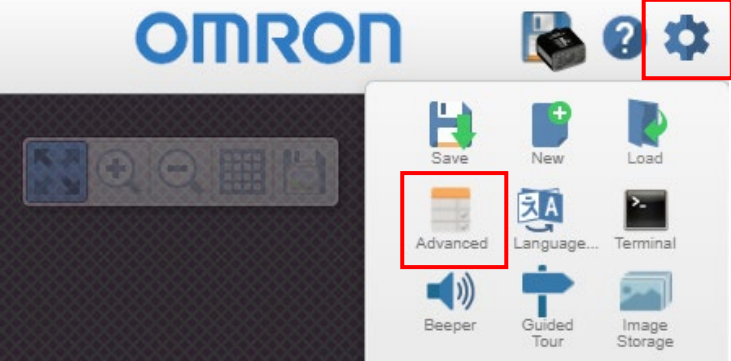

12 The Advanced Settings Screen appears. Select the **Communications** Tab and check that the settings are as follows.

[RS232A]
 Baud Rate: 115.2 K
 Parity: None
 Stop Bits: One
 Data Bits: Eight
 [Host Protocol]
 Protocol Selection: Point-to-Point
 [Preamble]
 Preamble: Disabled
 [Postamble]
 Postamble: Enabled
 Postamble Characters:
 <CR><LF>

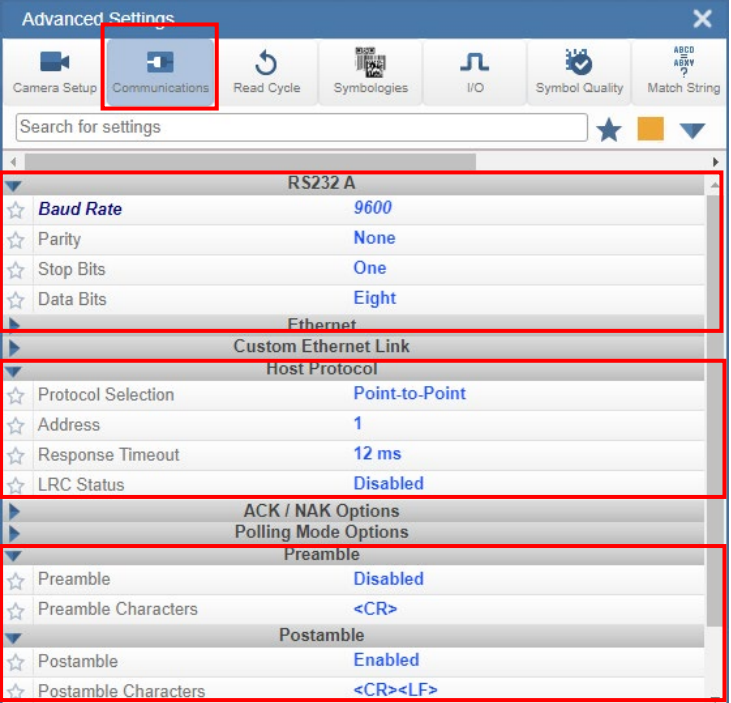

13 Click on the icon shown in the red frame to save the settings to the code reader.

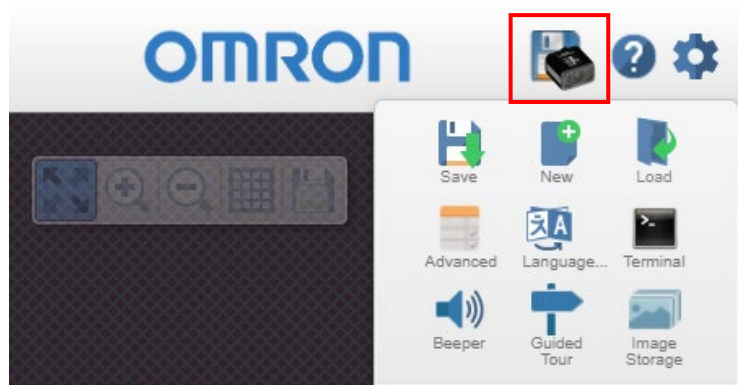

14 Finally, check the version number of the code reader. Click on the gear icon on the upper right of the screen and select **About WebLink**.

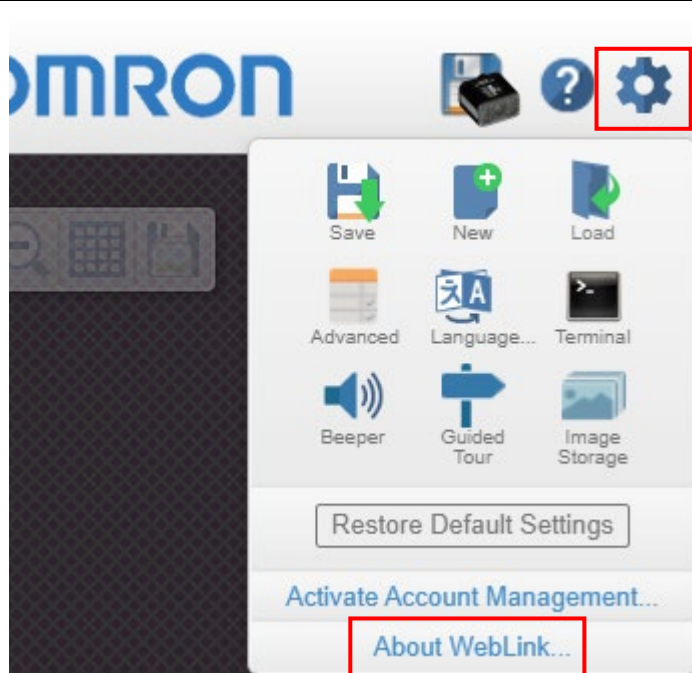

15 **About WebLink** is displayed, so you can check the current version of the code reader.

Please update the code reader to the latest version if necessary.



6.3. Controller Setup

Set up the controller.

6.3.1. Setting the Hardware

Check the connection of the Serial Communications Unit.



Precautions for Correct Use

Turn OFF the power supply before setting the hardware.

- 1 Confirm that the power supply to the controller is OFF.
 - * If the power supply is ON, you may not be able to proceed with the subsequent steps of the procedure.

Check the position of the "Port 2" (RS-232C) connector as shown in the figure on the right.

 - * It is assumed that "Port 2" of the Serial Communications Unit is used.

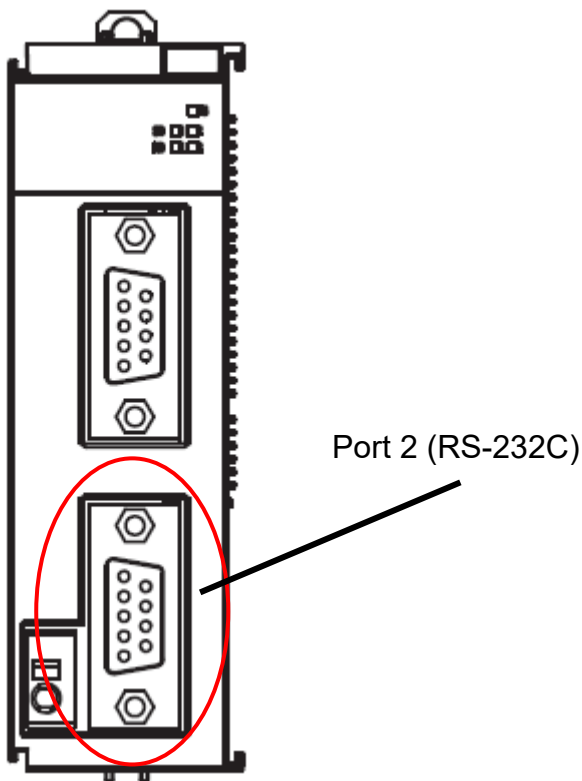

- 2 Connect the Serial Communications Unit to the controller, as shown in the figure on the right. Connect the dedicated cable of the code reader cable to the Serial Communications Unit. Connect the controller to the PC with a LAN cable.

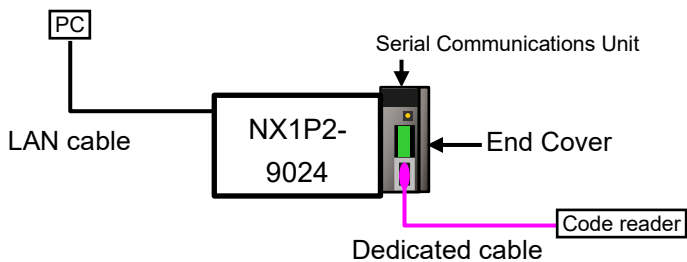

6.3.2. Starting the Sysmac Studio and Loading the Project File

Start the Sysmac Studio and load the project file.

Install the Sysmac Studio on the PC beforehand.

- 1 Make sure that the PC and controller are connected with a LAN cable, and turn ON the power supply to the controller.

Start the Sysmac Studio and click **Import**.

* If a user account control dialog box is displayed at startup, select the option to start.

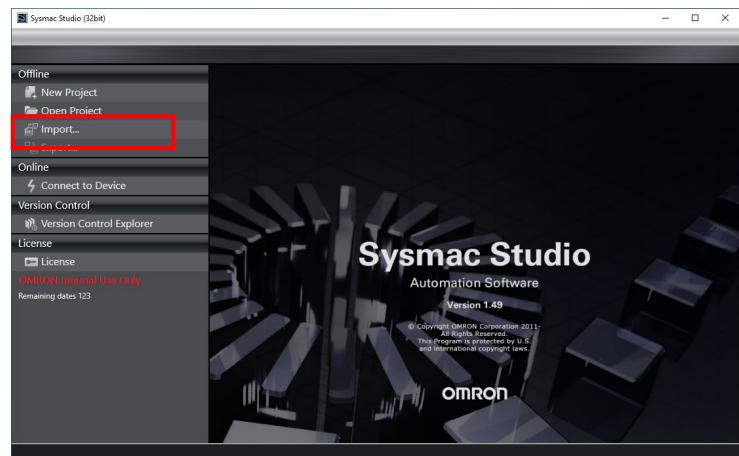

- 2 The **Import file** Dialog Box is displayed. Select **OMRON_V320_V420_V430_NX_RXD_V100.smc2** and click **Open**.

* Obtain the latest version of the project file from the OMRON website.

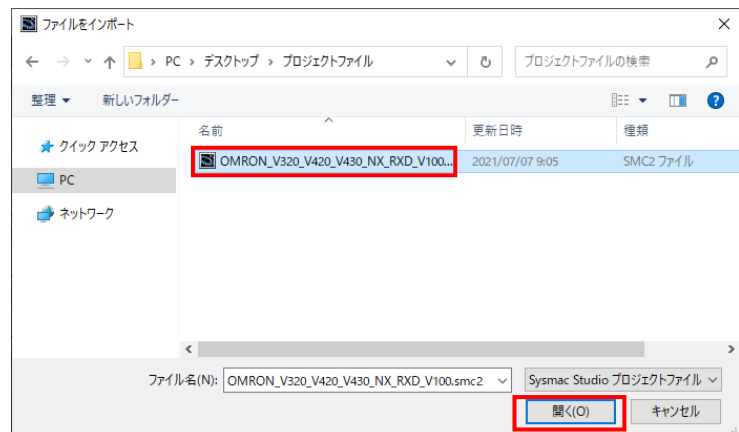

- 3 The **OMRON_V320_V420_V430_NX_RXD_V100.smc2** Project Window is displayed. The window consists of three panes: "Multiview Explorer" on the left side, "Edit Pane" in the center, and "Toolbox" on the right side.

* If the error message *Cannot compare the repositories, the version on the target different from the source.* is displayed, change the Sysmac Studio version to the version indicated in 5.2. *Device Configuration* or higher.

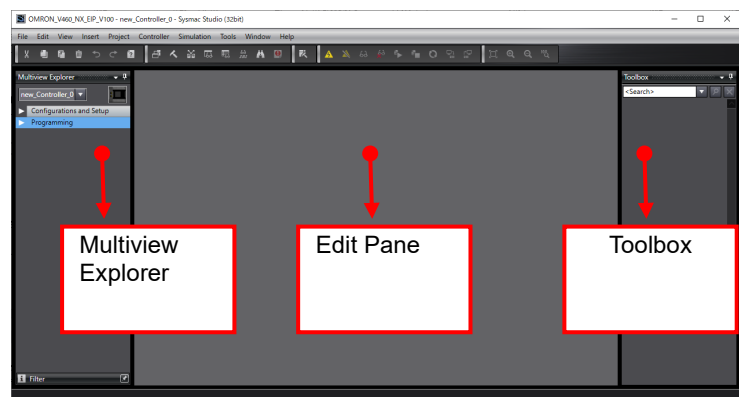

6.3.3. Checking Parameters and Executing Build

Check the setting parameters. Then, perform program checks and build on project data.

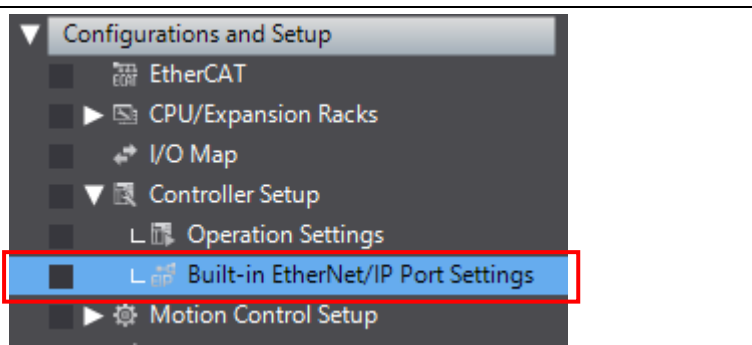
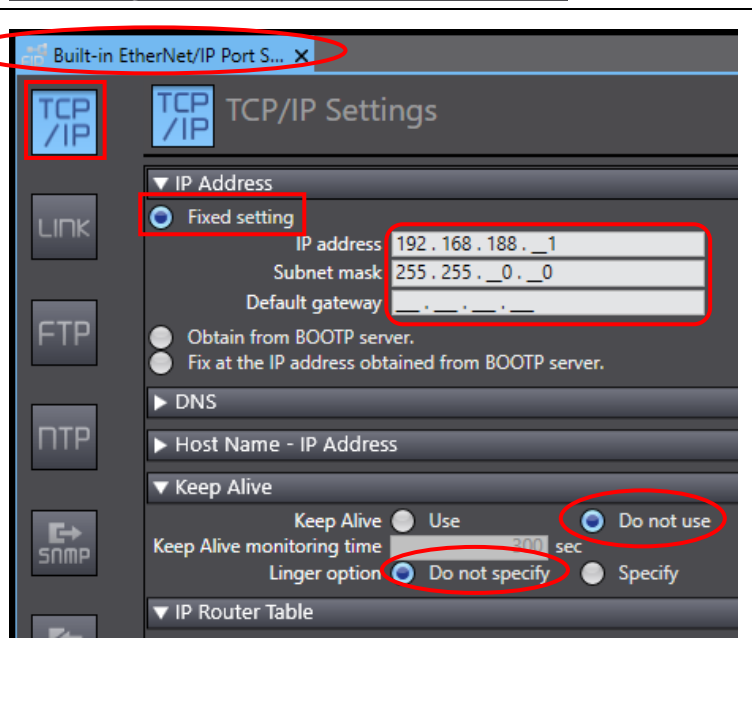
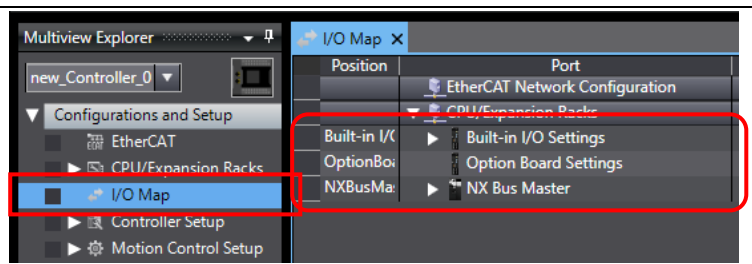
<p>1 Double-click Built-in EtherNet/IP Port Settings under Configurations and Setup – Controller Setup in the Multiview Explorer.</p>																																																																			
<p>2 The Built-in EtherNet/IP Port Settings Tab Page is displayed in the Edit Pane.</p> <p>Select TCP/IP, select the Fixed setting Option in IP Address, and check that the settings are as follows.</p> <p>IP Address: 192.168.188.1 Subnet mask: 255.255.0.0 Default gateway:</p> <p>Check that Keep Alive is set as follows.</p> <p>Keep Alive: Do not use Linger option: Do not specify</p>																																																																			
<p>3 Double-click I/O Map under Configurations and Setup in the Multiview Explorer. The I/O Map Tab Page showing the unit parameters is displayed.</p>																																																																			
<p>4 In the I/O Map Tab Page, check Node location information under NX-CIF210. Confirm that the Variable column shows N1_Node_location_information.</p>	<table border="1"> <thead> <tr> <th>Position</th> <th>Port</th> <th>Description</th> <th>R/W</th> <th>Data Type</th> <th>Variable</th> </tr> </thead> <tbody> <tr> <td></td> <td>EtherCAT Network Configuration</td> <td></td> <td></td> <td></td> <td></td> </tr> <tr> <td></td> <td>CPU/Expansion Racks</td> <td></td> <td></td> <td></td> <td></td> </tr> <tr> <td></td> <td>Built-in I/O</td> <td></td> <td></td> <td></td> <td></td> </tr> <tr> <td></td> <td>OptionBo</td> <td></td> <td></td> <td></td> <td></td> </tr> <tr> <td></td> <td>NXBusMa</td> <td></td> <td></td> <td></td> <td></td> </tr> <tr> <td></td> <td>Unit Status (Under management of</td> <td></td> <td></td> <td></td> <td></td> </tr> <tr> <td></td> <td>NX-CIF210</td> <td></td> <td></td> <td></td> <td></td> </tr> <tr> <td></td> <td>Node location information</td> <td>Node location information</td> <td>R</td> <td>_sNXUN</td> <td>N1_Node_location_information</td> </tr> <tr> <td></td> <td>Ch1 Port Status</td> <td>Ch1 Port Status</td> <td>R</td> <td>WORD</td> <td></td> </tr> <tr> <td></td> <td>Ch1 Input SID</td> <td>Ch1 Input SID</td> <td>R</td> <td>USINT</td> <td></td> </tr> </tbody> </table>	Position	Port	Description	R/W	Data Type	Variable		EtherCAT Network Configuration						CPU/Expansion Racks						Built-in I/O						OptionBo						NXBusMa						Unit Status (Under management of						NX-CIF210						Node location information	Node location information	R	_sNXUN	N1_Node_location_information		Ch1 Port Status	Ch1 Port Status	R	WORD			Ch1 Input SID	Ch1 Input SID	R	USINT	
Position	Port	Description	R/W	Data Type	Variable																																																														
	EtherCAT Network Configuration																																																																		
	CPU/Expansion Racks																																																																		
	Built-in I/O																																																																		
	OptionBo																																																																		
	NXBusMa																																																																		
	Unit Status (Under management of																																																																		
	NX-CIF210																																																																		
	Node location information	Node location information	R	_sNXUN	N1_Node_location_information																																																														
	Ch1 Port Status	Ch1 Port Status	R	WORD																																																															
	Ch1 Input SID	Ch1 Input SID	R	USINT																																																															

* If the setting is different, right-click on **Node location information** and select **Create Device Variable** from the menu, as shown in the figure on the right.

Position	Port	Description	R/W	Data Type	Variable
	Node location information	Node location information	R	ARRAY[0..3]	
	▶ Ch1 Port Status	Ch1 Port Status	R	WORD	Cut
	Ch1 Input SID	Ch1 Input SID	R	USINT	Copy
	Ch1 Output SID Response	Ch1 Output SID Response	R	USINT	Paste
	▶ Ch1 Input Data Type	Ch1 Input Data Type	R	WORD	Undo
	Ch1 Input Sub Info	Ch1 Input Sub Info	R	WORD	Redo
	Ch1 Input Data Length	Ch1 Input Data Length	R	UINT	Search
	▶ Ch1 Input Data 01	Ch1 Input Data 01	R	ARRAY[0..3]	Expand/Collapse All
	▶ Ch1 Input Data 02	Ch1 Input Data 02	R	ARRAY[0..3]	
	▶ Ch1 Input Data 03	Ch1 Input Data 03	R	ARRAY[0..3]	Create Device Variable
	▶ Ch1 Input Data 04	Ch1 Input Data 04	R	ARRAY[0..3]	Create Device Variable with Prefix
	▶ Ch1 Input Data 05	Ch1 Input Data 05	R	ARRAY[0..3]	
	Ch1 Output SID	Ch1 Output SID	W	USINT	Cancel Variable Assignment
	Ch1 Input SID Response	Ch1 Input SID Response	W	USINT	Delete Variable
	▶ Ch1 Output Data Type	Ch1 Output Data Type	W	WORD	

5 Double-click **Task Settings** under **Configurations and Setup** in the Multiview Explorer.

6 The Task Settings Tab Page is displayed in Edit Pane. Select **Program Assignment Settings** and confirm that *Program0* is set in **PrimaryTask**.

7 Select **Rebuild Controller** from the **Project** Menu.

Click **Yes**.

A dialog box showing the progress of conversion appears.

8 In the **Build** Tab Page, confirm that **0** is shown for both **Errors** and **Warnings**.



6.3.4. Going Online and Transferring the Project Data

Place the Sysmac Studio online and transfer the project data to the controller.

WARNING

Always confirm safety at the destination node before you transfer a user program, configuration and setup data, device variables, or values in memory used for NX-series Units from the Sysmac Studio.

The devices or machines may perform unexpected operation regardless of the operating mode of the CPU Unit.



Caution

Be sure to confirm safety before resetting the controller or unit.



- 1** Select **Change Device** from the **Controller** Menu.

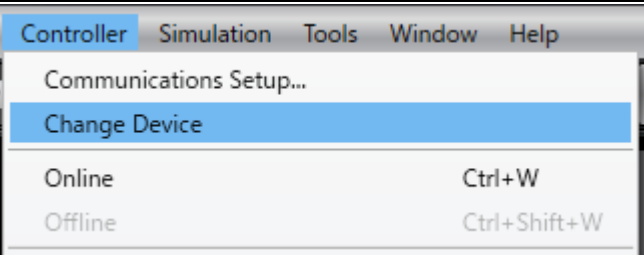

- 2** The **Change Device** Dialog Box is displayed. Confirm that **Device** and **Version** are set to use the controller as shown in the figure on the right, and click **Cancel**.

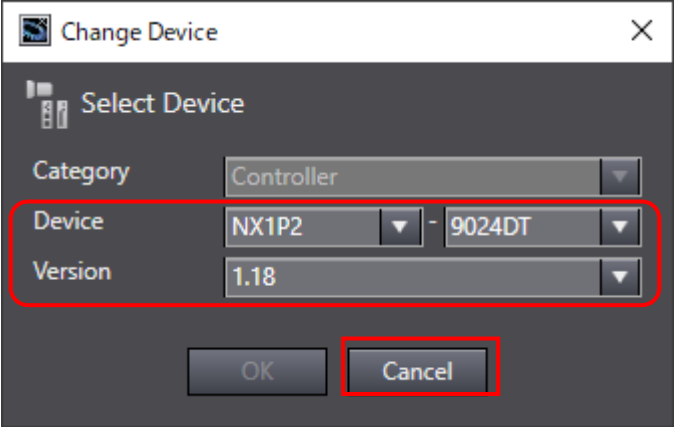
* If the settings are different, set them to be the same by selecting from the pull-down menu. After changing the settings, click **OK**.

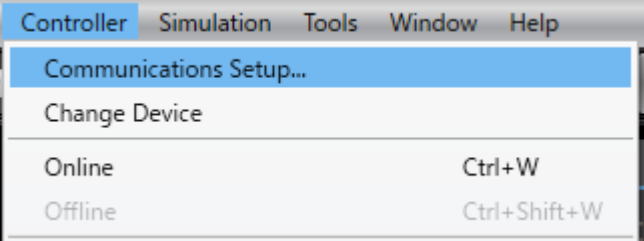

- 3** Select **Communications Setup** from the **Controller** Menu.

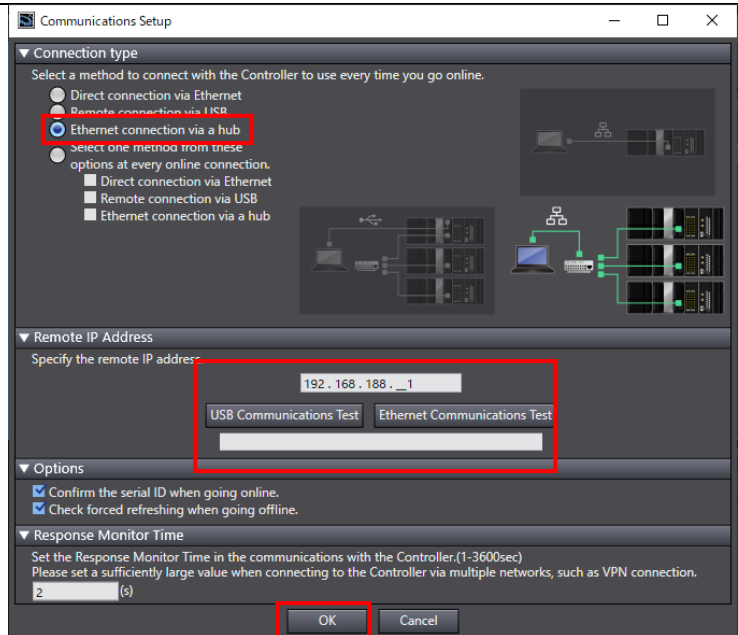

4 The Communications Setup Dialog Box is displayed. Make sure that the **Ethernet connection via a hub** Option is selected in **Connection type**. Also, enter **192.168.188.1** in **Remote IP Address**. Click on **Ethernet Communications Test** and confirm that *Communications test OK* is displayed. Click **OK**.

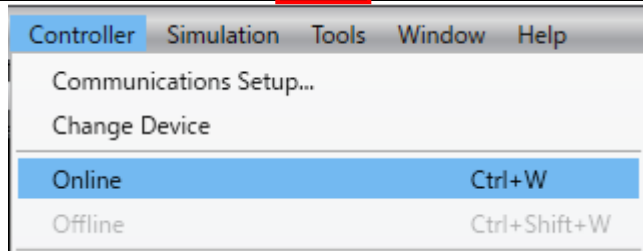

5 Select **Online** from the **Controller** Menu.



A confirmation dialog box appears. Click **Yes**.

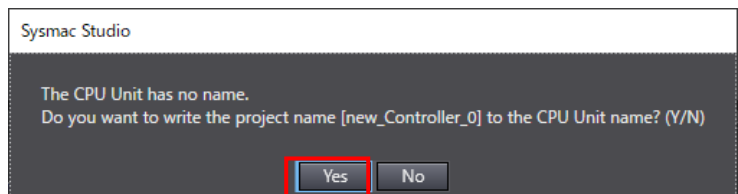

* The dialog box displayed differs depending on the status of the controller being used. Select **Yes** to proceed with the operation.

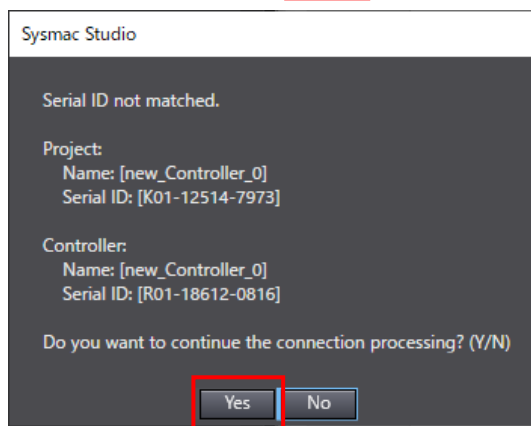

* The serial IDs displayed vary depending on the device.

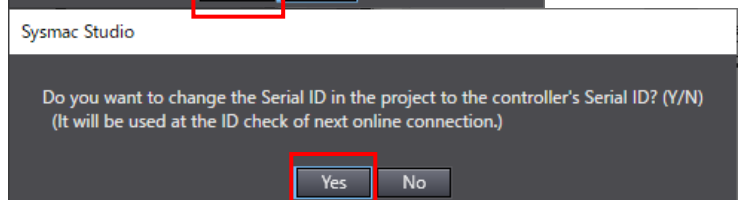

Note

Refer to *Section 6 Online Connections to a Controller* in the *Sysmac Studio Version 1 Operation Manual* (Cat. No. W504) for details on online connection to the controller.

6 When you are online, a yellow border appears in the upper part of the Edit Pane.



7 Select **Synchronize** from the **Controller** Menu.

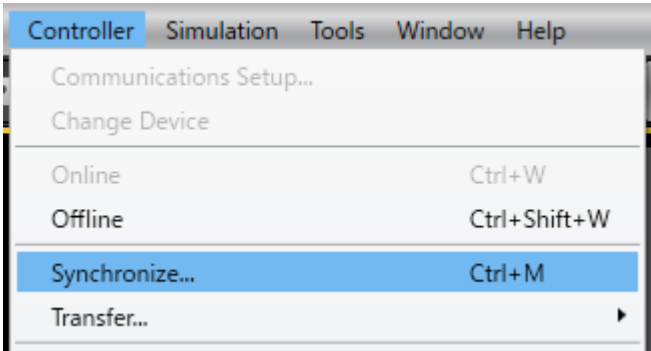

8 The **Synchronization** Dialog Box is displayed. Confirm that the check box for the data to transfer (i.e. **NX1P2** on the figure on the right) is selected, and click **Transfer to Controller**.

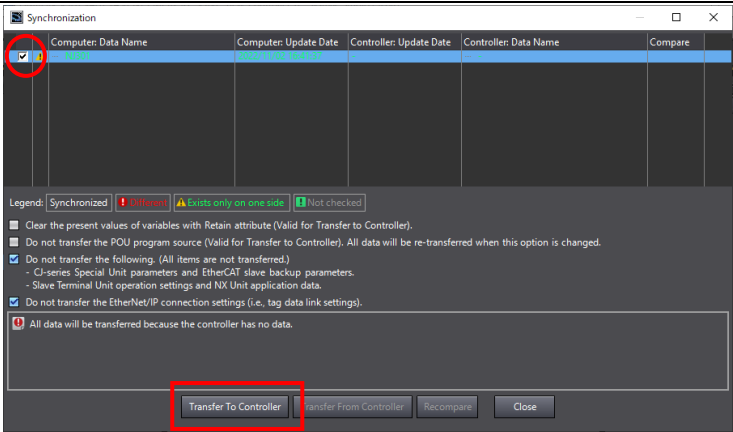

* Executing **Transfer to Controller** transfers the project data from the Sysmac Studio to the controller for data comparison.

9 A confirmation dialog box appears. Click **Yes**.

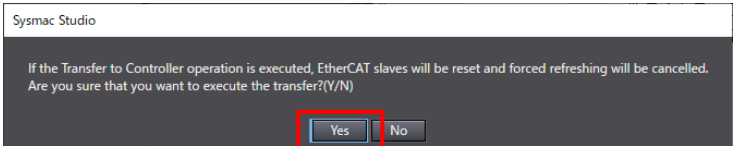

The Synchronizing Dialog Box appears.



10 Confirm that the synchronized data is now shown in the text color of **Synchronized** and the following message is displayed: *The Synchronization process successfully finished.* If there is no problem, click **Close**.

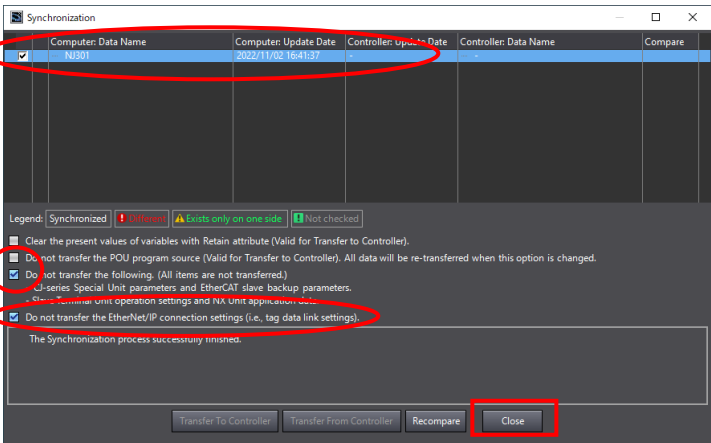

* If synchronization fails, check the physical connections and redo the procedure.

11 Select **Reset Controller** from the **Controller** Menu.

* If **Reset Controller** is grayed out, the operating mode is RUN mode. Select **Mode – PROGRAM** from the **Controller** Menu to change to PROGRAM mode, and then perform the procedure in this section.

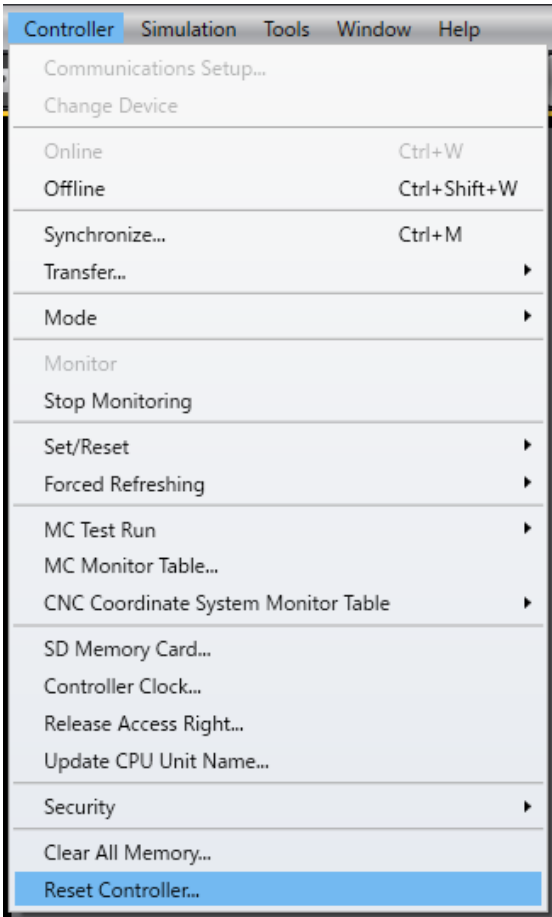

12 A series of confirmation dialog boxes appear. Click **Yes** to proceed.

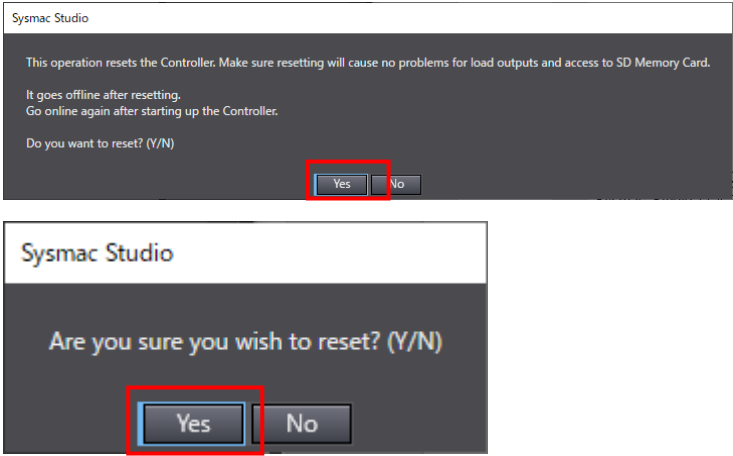

13 The controller is reset. The Sysmac Studio goes offline and the yellow border in the upper part of the Edit Pane disappears. Perform steps 6 to 8 to go online again.

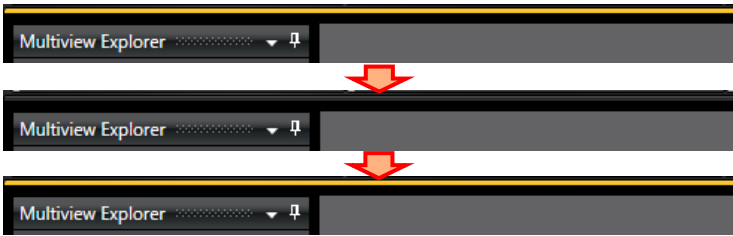

6.3.5. Transferring the Unit Settings

Transfer the setting data for the Serial Communications Unit.

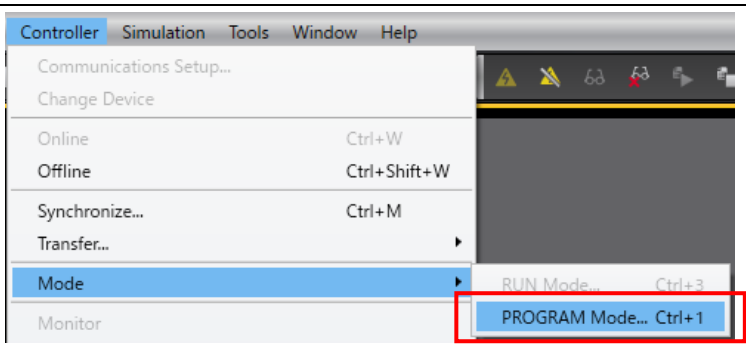
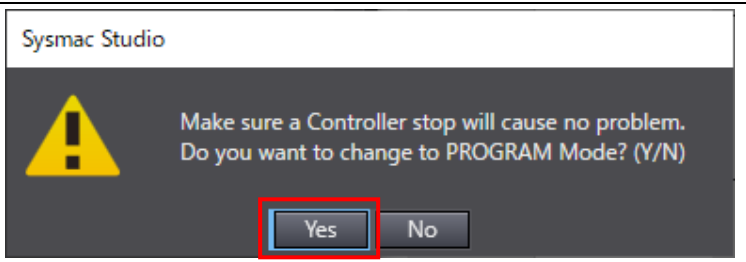
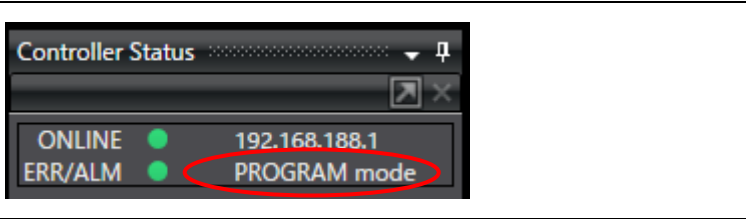
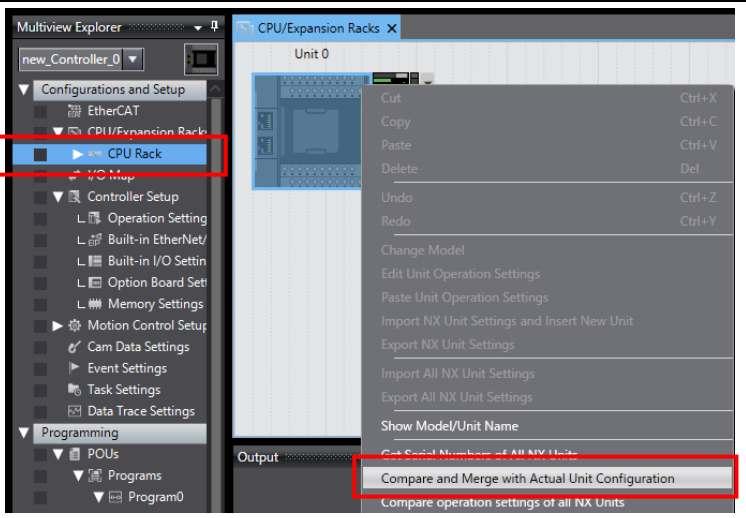
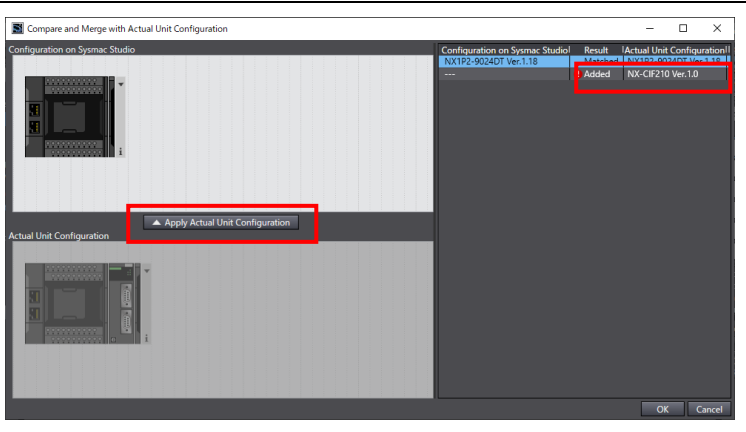
<p>1 Select Mode – PROGRAM Mode from the Controller Menu.</p>	
<p>2 A confirmation dialog box appears. Click Yes.</p>	
<p>3 In Controller Status, PROGRAM mode is shown.</p>	
<p>4 Double-click CPU Rack under Configurations and Setup – CPU/Expansion Racks in the Multiview Explorer.</p> <p>Right-click on the NX Unit and select Compare and Merge with Actual Unit Configuration from the menu.</p>	
<p>5 In the Compare and Merge with Actual Unit Configuration Dialog Box, confirm that the Result and Actual Unit Configuration columns show Added and NX-CIF210, respectively.</p> <p>Click the Apply Actual Unit Configuration Button.</p>	

6 Confirm that the **Result** and **Actual Unit Configuration** columns show **Matched** and **NX-CIF210**, respectively.

Click **OK**.

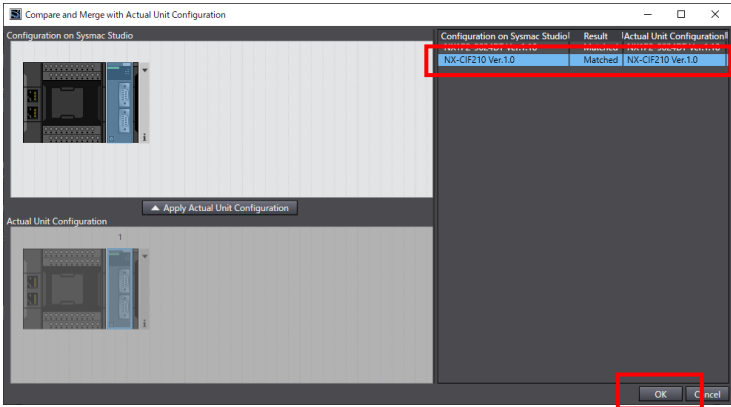

7 Select the Serial Communications Unit in the tab page. Click **Edit Unit Operation Settings**.

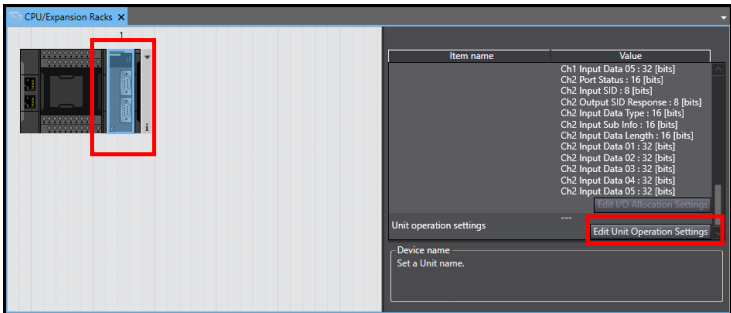

8 The **Unit 1[NXBusMaster] Tab Page** is displayed. Click **All parameters** and select **Ch2**.

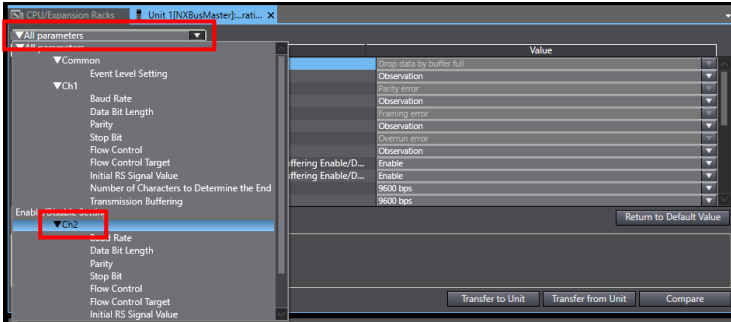

9 Check if the settings are the same as those listed in 5.1 *Serial Communications Settings*.

If the settings are different, match the settings.

Click **Transfer to Unit**.

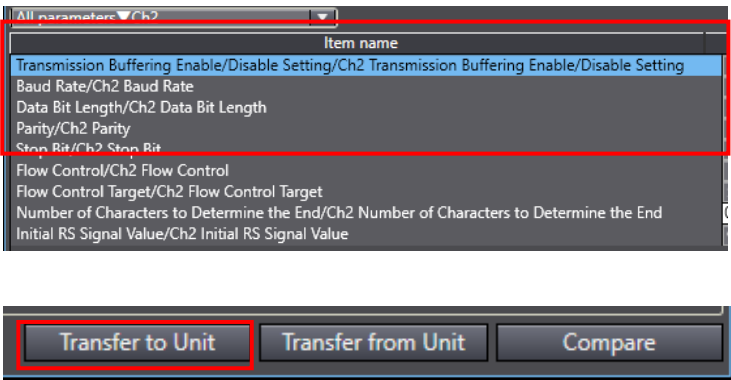

10 A confirmation dialog box is displayed. Click **Yes**.

The Transferring Dialog Box appears and then closes.

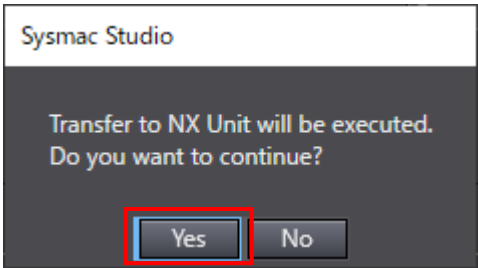

11 Open the **Parameter group** to show pull-down menu and select **All parameters ▼ Ch2**. Click **Compare**.

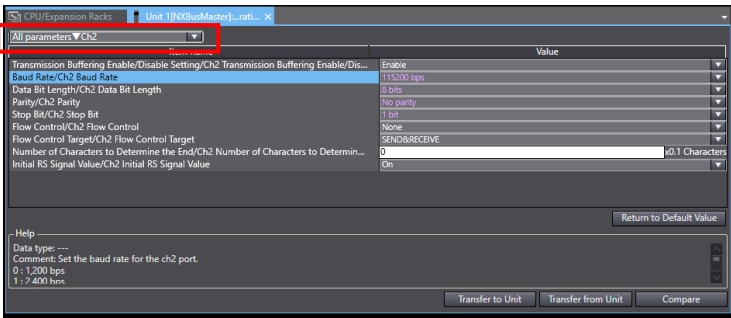

12 Check that **≠** (mismatch) is not shown in the red frame in the figure on the right.

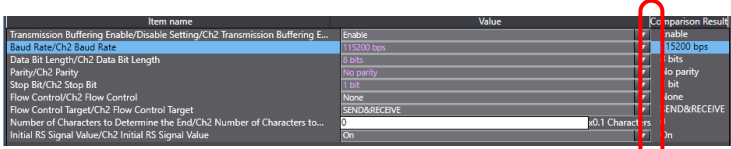

6.4. Checking That Serial Communications Work

Execute the program to check that serial communications work correctly.

 **Caution**

Sufficiently confirm safety before you change the values of variables on a Watch Tab Page when the Sysmac Studio is online with the CPU Unit. Incorrect operation may cause the devices that are connected to Output Units to operate regardless of the operating mode of the controller.







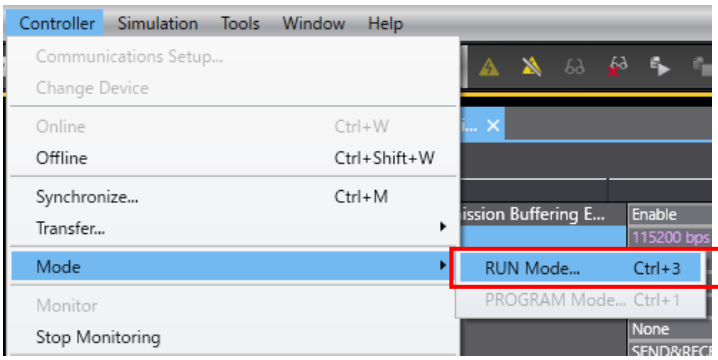
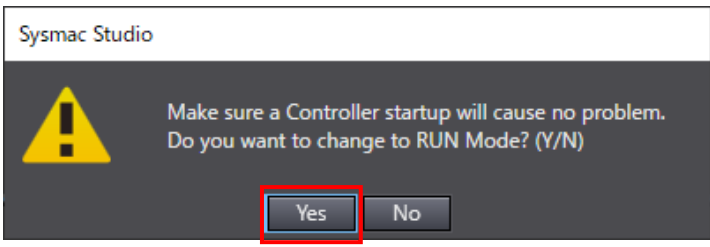
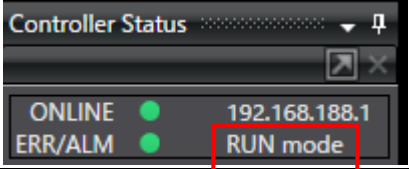

Precautions for Correct Use

Before performing the following steps, confirm that the serial cable is connected securely. If it is not connected, first turn OFF the power supply to the device and then connect the serial cable.

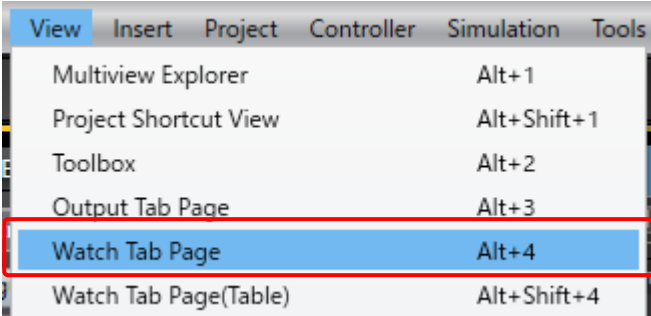
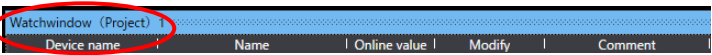
6.4.1. Executing the Program

Execute the program in the Sysmac Studio.

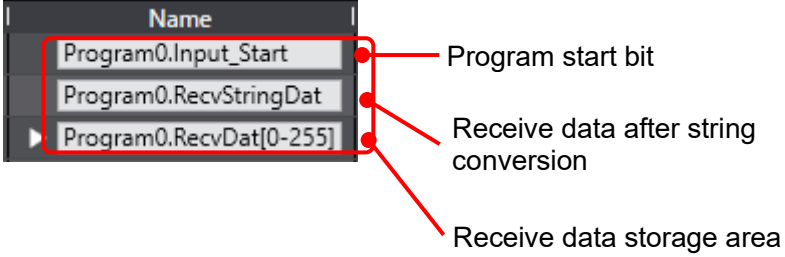
1	Select Mode – RUN Mode from the Controller Menu.	
2	A confirmation dialog box appears. Click Yes .	
3	In Controller Status , RUN mode is shown.	

- 4** In the Sysmac Studio, select **Watch Tab Page** from the **View** Menu.
- 
- 5** The **Watchwindow (Project) 1** Tab Page is displayed under the Edit Pane.
- 
- 6** Confirm that the variables shown in the figure on the right are listed in the **Name** column.
- * To add a variable, click **Input Name**.
 - * If  is displayed in the place of  to the left of the variable, click on the  to expand the structure variable.
 - * In the following description, "Program0" of the variable names in the **Name** column is omitted.
- 
- 7** This document uses a barcode as shown in the figure on the right as an example of reading. Use the code reader to read the barcode shown in the figure on the right.
- 

6.4.2. Checking the Receive Data

In the Sysmac Studio, check that correct data is written to the controller variables.

<p>1 Check the received data (read code) in the Watch Tab Page of the Sysmac Studio.</p> <p>* In the example figure on the right, the data stored in <i>RecvStringDat</i> is "4912345678904".</p> <p>* The contents of the read barcode are stored in <i>RecvDat[0]</i> to <i>RecvDat[12]</i>.</p>	<table border="1"> <tr> <td>Program0.RecvStringDat</td> <td>4912345678904</td> <td></td> </tr> <tr> <td>▼ Program0.RecvDat[0-255]</td> <td></td> <td></td> </tr> <tr> <td>RecvDat[0]</td> <td>4 (16#34)</td> <td></td> </tr> <tr> <td>RecvDat[1]</td> <td>9 (16#39)</td> <td></td> </tr> <tr> <td>RecvDat[2]</td> <td>1 (16#31)</td> <td></td> </tr> <tr> <td>RecvDat[3]</td> <td>2 (16#32)</td> <td></td> </tr> <tr> <td>RecvDat[4]</td> <td>3 (16#33)</td> <td></td> </tr> <tr> <td>RecvDat[5]</td> <td>4 (16#34)</td> <td></td> </tr> <tr> <td>RecvDat[6]</td> <td>5 (16#35)</td> <td></td> </tr> <tr> <td>RecvDat[7]</td> <td>6 (16#36)</td> <td></td> </tr> <tr> <td>RecvDat[8]</td> <td>7 (16#37)</td> <td></td> </tr> <tr> <td>RecvDat[9]</td> <td>8 (16#38)</td> <td></td> </tr> <tr> <td>RecvDat[10]</td> <td>9 (16#39)</td> <td></td> </tr> <tr> <td>RecvDat[11]</td> <td>0 (16#30)</td> <td></td> </tr> <tr> <td>RecvDat[12]</td> <td>4 (16#34)</td> <td></td> </tr> <tr> <td>RecvDat[13]</td> <td>. (16#00)</td> <td></td> </tr> <tr> <td>RecvDat[14]</td> <td>. (16#00)</td> <td></td> </tr> </table>	Program0.RecvStringDat	4912345678904		▼ Program0.RecvDat[0-255]			RecvDat[0]	4 (16#34)		RecvDat[1]	9 (16#39)		RecvDat[2]	1 (16#31)		RecvDat[3]	2 (16#32)		RecvDat[4]	3 (16#33)		RecvDat[5]	4 (16#34)		RecvDat[6]	5 (16#35)		RecvDat[7]	6 (16#36)		RecvDat[8]	7 (16#37)		RecvDat[9]	8 (16#38)		RecvDat[10]	9 (16#39)		RecvDat[11]	0 (16#30)		RecvDat[12]	4 (16#34)		RecvDat[13]	. (16#00)		RecvDat[14]	. (16#00)	
Program0.RecvStringDat	4912345678904																																																			
▼ Program0.RecvDat[0-255]																																																				
RecvDat[0]	4 (16#34)																																																			
RecvDat[1]	9 (16#39)																																																			
RecvDat[2]	1 (16#31)																																																			
RecvDat[3]	2 (16#32)																																																			
RecvDat[4]	3 (16#33)																																																			
RecvDat[5]	4 (16#34)																																																			
RecvDat[6]	5 (16#35)																																																			
RecvDat[7]	6 (16#36)																																																			
RecvDat[8]	7 (16#37)																																																			
RecvDat[9]	8 (16#38)																																																			
RecvDat[10]	9 (16#39)																																																			
RecvDat[11]	0 (16#30)																																																			
RecvDat[12]	4 (16#34)																																																			
RecvDat[13]	. (16#00)																																																			
RecvDat[14]	. (16#00)																																																			
<p>2 Then, use the code reader to read the code shown in the figure on the right.</p>	<div style="text-align: center;">  <p>1234567890</p> </div>																																																			
<p>3 RecvStringDat and RecvDat are updated, and you can see that the contents of the code just read are stored.</p>	<table border="1"> <tr> <td>Program0.RecvStringDat</td> <td>1234567890</td> <td></td> </tr> <tr> <td>▼ Program0.RecvDat[0-255]</td> <td></td> <td></td> </tr> <tr> <td>RecvDat[0]</td> <td>1 (16#31)</td> <td></td> </tr> <tr> <td>RecvDat[1]</td> <td>2 (16#32)</td> <td></td> </tr> <tr> <td>RecvDat[2]</td> <td>3 (16#33)</td> <td></td> </tr> <tr> <td>RecvDat[3]</td> <td>4 (16#34)</td> <td></td> </tr> <tr> <td>RecvDat[4]</td> <td>5 (16#35)</td> <td></td> </tr> <tr> <td>RecvDat[5]</td> <td>6 (16#36)</td> <td></td> </tr> <tr> <td>RecvDat[6]</td> <td>7 (16#37)</td> <td></td> </tr> <tr> <td>RecvDat[7]</td> <td>8 (16#38)</td> <td></td> </tr> <tr> <td>RecvDat[8]</td> <td>9 (16#39)</td> <td></td> </tr> <tr> <td>RecvDat[9]</td> <td>0 (16#30)</td> <td></td> </tr> <tr> <td>RecvDat[10]</td> <td>. (16#00)</td> <td></td> </tr> <tr> <td>RecvDat[11]</td> <td>. (16#00)</td> <td></td> </tr> <tr> <td>RecvDat[12]</td> <td>. (16#00)</td> <td></td> </tr> <tr> <td>RecvDat[13]</td> <td>. (16#00)</td> <td></td> </tr> </table>	Program0.RecvStringDat	1234567890		▼ Program0.RecvDat[0-255]			RecvDat[0]	1 (16#31)		RecvDat[1]	2 (16#32)		RecvDat[2]	3 (16#33)		RecvDat[3]	4 (16#34)		RecvDat[4]	5 (16#35)		RecvDat[5]	6 (16#36)		RecvDat[6]	7 (16#37)		RecvDat[7]	8 (16#38)		RecvDat[8]	9 (16#39)		RecvDat[9]	0 (16#30)		RecvDat[10]	. (16#00)		RecvDat[11]	. (16#00)		RecvDat[12]	. (16#00)		RecvDat[13]	. (16#00)				
Program0.RecvStringDat	1234567890																																																			
▼ Program0.RecvDat[0-255]																																																				
RecvDat[0]	1 (16#31)																																																			
RecvDat[1]	2 (16#32)																																																			
RecvDat[2]	3 (16#33)																																																			
RecvDat[3]	4 (16#34)																																																			
RecvDat[4]	5 (16#35)																																																			
RecvDat[5]	6 (16#36)																																																			
RecvDat[6]	7 (16#37)																																																			
RecvDat[7]	8 (16#38)																																																			
RecvDat[8]	9 (16#39)																																																			
RecvDat[9]	0 (16#30)																																																			
RecvDat[10]	. (16#00)																																																			
RecvDat[11]	. (16#00)																																																			
RecvDat[12]	. (16#00)																																																			
RecvDat[13]	. (16#00)																																																			

Appendix 1. Initializing the System

This document assumes that each device uses the factory default settings.

If you change their settings from the defaults, you may not be able to perform various setting procedures as described.

A1.1. Initializing the Controller

In order to initialize the controller, both the CPU Unit and the Serial Communications Unit must be initialized. Please put the controller in PROGRAM mode before initialization.

A1.1.1. Serial Communications Unit (NX Unit)

To return the NX-CIF210 Serial Communication Units to its default settings, in the Sysmac Studio, select it in the **CPU/Expansion Racks** Tab Page and click **Edit Special Unit Settings**.

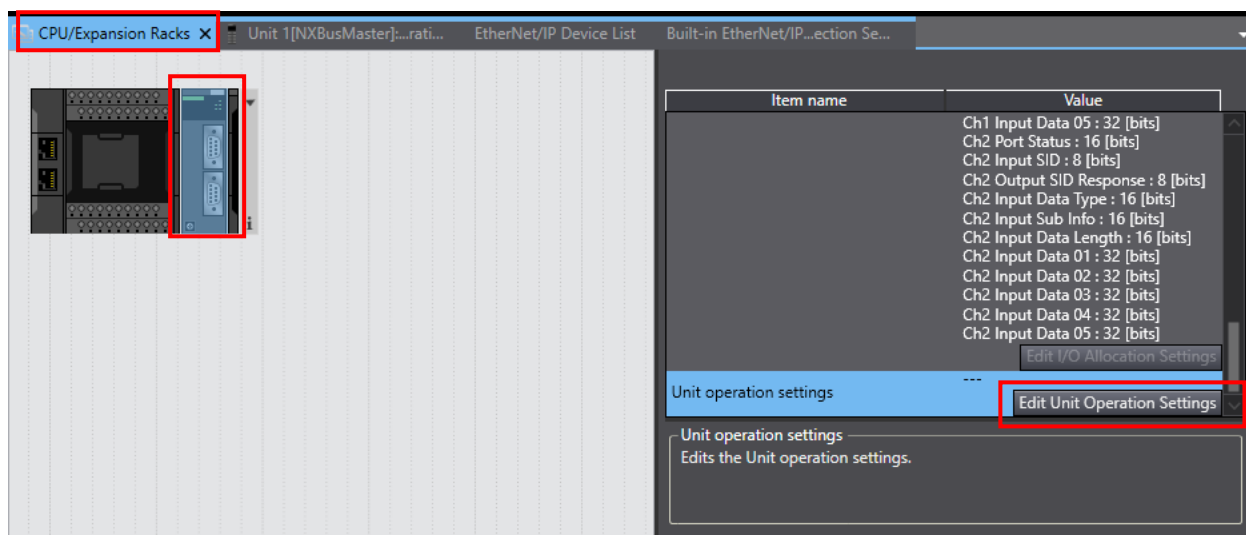

Select **Return to Default Value**, and then select **Transfer to Unit**.

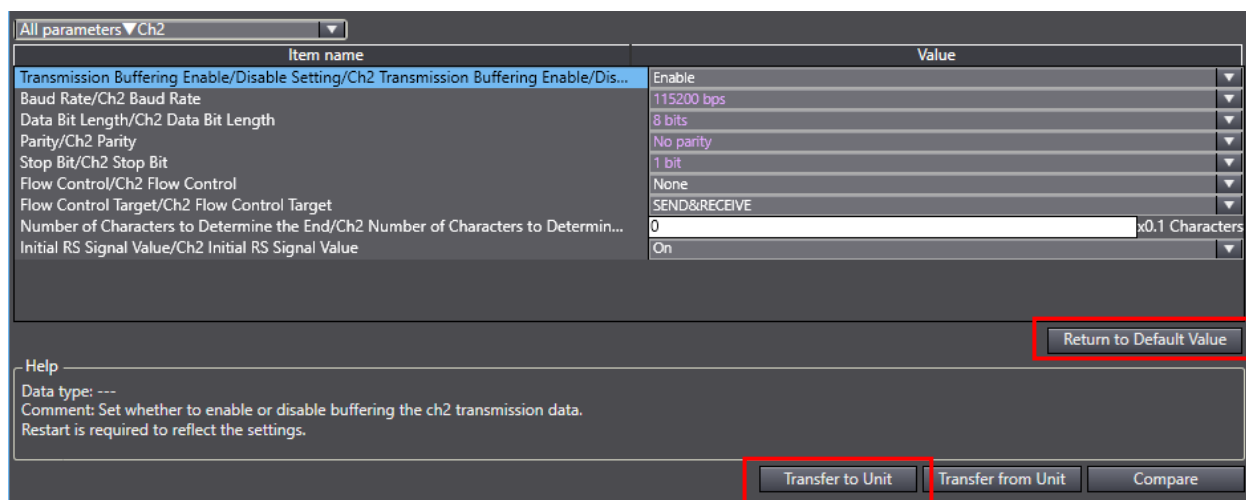

A1.1.2 CPU Unit

To return the controller to its default settings, select **Clear All Memory** from **Controller Menu** in the Sysmac Studio. When the Clear All Memory Dialog Box is displayed, click **OK**.

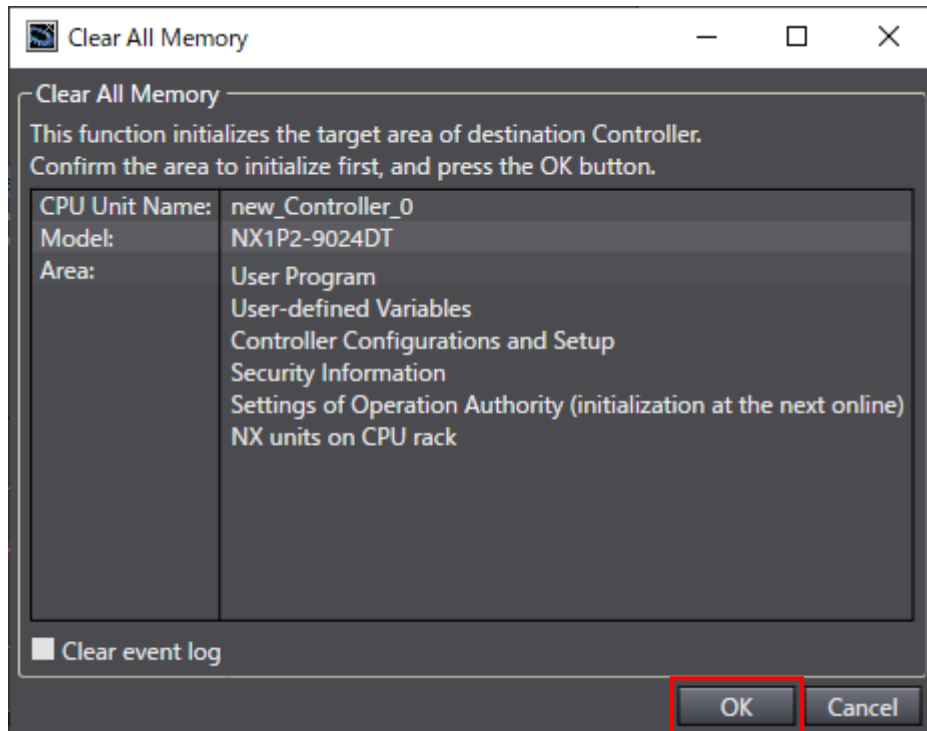

A1.2. Initializing the Code Reader

For information on initializing the code reader, please refer to *How to initialize the settings?* in Q&A in *Appendices* of the *MicroHAWK V320-F/V330-F/V420-F/V430-F Series Barcode Reader User Manual* (Cat. No. Z432).

Appendix 2. Ladder Program

A2.1. Overview

This section describes the ladder program specifications and functions for connecting the code reader to an NX Series Serial Communications Unit.

This ladder program stores “code data” from the code reader in the memory of the NX Series CPU Unit.



Note

We have verified in our test configuration that the ladder program enables communications for the product versions and product lot used for evaluation.

However, we do not guarantee its operations where there are electrical noise or other disturbances, or variations in the performance of the devices themselves.



Note

Contact OMRON for information on how to obtain the ladder program.

A2.1.1. Communications Data Flow

This is the flow of communications in which the NX Series CPU Unit receives data from the code reader.

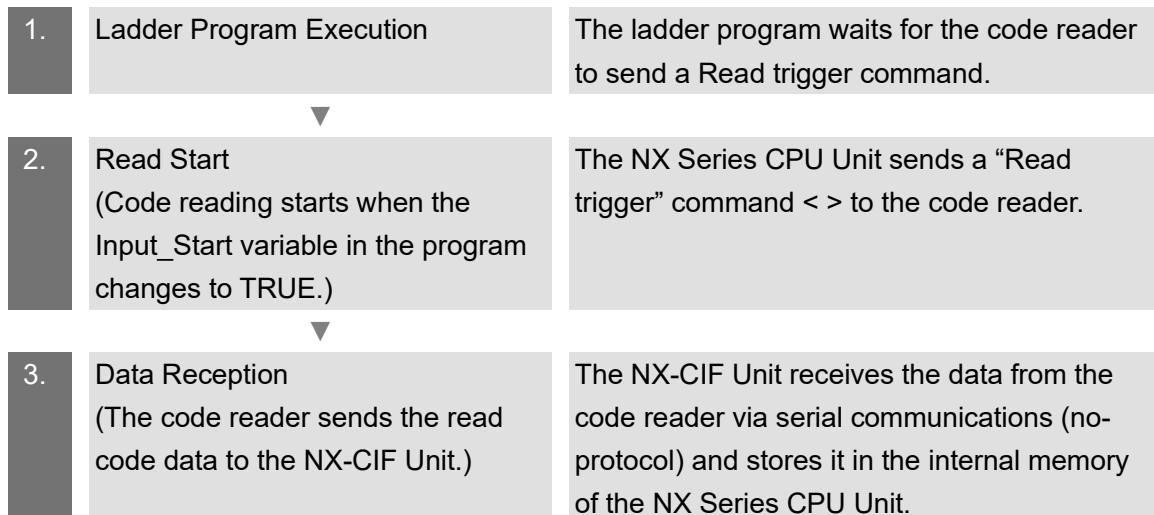

A2.1.2. NX_SerialRcv Instruction

This section describes the serial communications instruction (instruction word: NX_SerialRcv).



Note

For details, refer to *Serial Communications Instructions (NX_SerialRcv)* in *Section 2 Instruction Descriptions* in the *NJ/NX-series Instructions Reference Manual (Cat. No. W502)*.

- Operation

The NX_SerialRcv instruction reads data in No-protocol Mode from a serial port on an NX Series Communications Interface Unit or Option Board.

- NX_SerialRcv Instruction

Instruction	Name	FB/ FUN	Graphic expression	ST expression
NX_SerialRcv	Receive No-protocol Data	FB		NX_SerialRcv_instance(Execute, DevicePort, RcvDat, Size, RcvCfg, Option, Abort, Done, Busy, CommandAborted, Error, ErrorID, RcvSize);

- Variables and Data Types Used in SerialRcv Instruction

	Meaning	I/O	Description	Valid range	Unit	Default
DevicePort	Device port	Input	Object that represents a device port	—	—	—
Size	Storage size		Size of RcvDat in bytes	1 to 4096	Bytes	1
RcvCfg	Reception completion setting		Reception completion setting	—	—	—
Option	Option		Option	—	—	—
Abort	Interruption		Interruption of instruction execution	—	—	FALSE
RcvDat[] (array)	Receive data	In-out	Variable to store data received from the receive buffer	Depends on data type.	—	—
CommandAborted	Interruption completion	Output	Interruption completion	Depends on data type.	—	—
RcvSize	Receive size		Size of data actually received from the receive buffer	0 to 4096	Bytes	—

	Boo lean	Bit strings				Integers								Real num- bers		Times, durations, dates, and text strings				
	BOOL	BYTE	WORD	DWORD	LWORD	USINT	UINT	UDINT	ULINT	SINT	INT	DINT	LINT	REAL	LREAL	TIME	DATE	TOD	DT	STRING
DevicePort	Refer to <i>Function</i> on page 2-1376 for details on the structure <code>_sDEVICE_PORT</code> .																			
Size							OK													
RcvCfg	Refer to <i>Function</i> on page 2-1376 for details on the structure <code>_sSERIAL_CFG</code> .																			
Option	Refer to <i>Function</i> on page 2-1376 for details on the structure <code>_sSERIAL_RCV_OPTION</code> .																			
Abort	OK																			
RcvDat[] (ar- ray)		OK																		
CommandA- borted	OK																			
RcvSize							OK													

A2.2. Program in Ladder Language

A2.2.1. Functional Components of Program

This program is written in the ladder language. The functional components of the program are as follows.

Type	Function
1. Trigger condition generation	Reads the code when the Input_Start bit changes to TRUE.
2. End condition generation	Ends the processing when receive data storage is completed.
3. Command execution	Sets communications parameters and clears the Receive Data Storage Area.
4. Serial reception	Executes the NX_SerialRcv instruction. Receive data is converted and output.

A2.3. Variables Used

This section describes variables used in the program.

A2.3.1. User-defined Variables

The tables below list data types, external variables (user-defined global variables, device variables for the NX Unit, and system-defined variables), and internal variables used in this program.

- External Variables

User-defined Global Variables

Variable name	Data type	Description
NXBus_N1_NX_Unit_I_O_Data_Active_Status	BOOL	Availability of I/O data in NX Unit
N1_Node_location_information	_sNXUINT_ID	Device variable to specify NX-CIF210



Note

For variables used with the Serial Communications Unit, refer to *Section 1 Instruction Set of the Machine Automation Controller NJ/NX-series Instructions Reference Manual* (Cat. No. W502).

- Internal Variables

Variable name	Data type	Description
Input_Start	BOOL	Variable to start program
Trigger	BOOL	Read processing instruction of code reader
OperatingEnd	BOOL	End of processing
Operating	BOOL	In processing
Operating2	BOOL	In processing (Serial send completed)
DevicePort	_sDEVICE_PORT	Port specification
SendDat	ARRAY[0..2] OF BYTE	Send data
SendSize	UINT	Send data size
SendCfg	_sSERIAL_CFG	---
RecvDat	ARRAY[0..255] OF BYTE	Receive data
RecvSize	UINT	Receive data size
RecvStringDat	STRING[255]	Barcode data (string)
RS_instance	RS	Reset-priority keep
RcvCfg	_sSERIAL_CFG	---
SerialSend_FBinstance	NX_SerialSend	---
SerialRcv_FBinstance	NX_SerialRcv	---

Revision History

Revision Code	Revision Date	Revised Reason and Page
01	April 2023	First Publication

OMRON Corporation Industrial Automation Company

Kyoto, JAPAN

Contact : www.ia.omron.com

Regional Headquarters

OMRON EUROPE B.V.

Wegalaan 67-69, 2132 JD Hoofddorp
The Netherlands
Tel: (31) 2356-81-300 Fax: (31) 2356-81-388

OMRON ASIA PACIFIC PTE. LTD.

438B Alexandra Road, #08-01/02 Alexandra
Technopark, Singapore 119968
Tel: (65) 6835-3011 Fax: (65) 6835-2711

OMRON ELECTRONICS LLC

2895 Greenspoint Parkway, Suite 200
Hoffman Estates, IL 60169 U.S.A.
Tel: (1) 847-843-7900 Fax: (1) 847-843-7787

OMRON (CHINA) CO., LTD.

Room 2211, Bank of China Tower,
200 Yin Cheng Zhong Road,
PuDong New Area, Shanghai, 200120, China
Tel: (86) 21-5037-2222 Fax: (86) 21-5037-2200

Authorized Distributor:

©OMRON Corporation 2023 All Rights Reserved.
In the interest of product improvement,
specifications are subject to change without notice.

Cat. No. Z465-E1-01 0423