

DeviceNet Safety

SYSTEM CONFIGURATION MANUAL

OMRON

NOTE

All rights reserved. No part of this publication may be reproduced, stored in a retrieval system, or transmitted, in any form, or by any means, mechanical, electronic, photocopying, recording, or otherwise, without the prior written permission of OMRON.

No patent liability is assumed with respect to the use of the information contained herein. Moreover, because OMRON is constantly striving to improve its high-quality products, the information contained in this manual is subject to change without notice. Every precaution has been taken in the preparation of this manual. Nevertheless, OMRON assumes no responsibility for errors or omissions. Neither is any liability assumed for damages resulting from the use of the information contained in this publication.

Trademarks

- Microsoft, Windows, and Windows Vista are either registered trademarks or trademarks of Microsoft Corporation in the United States and other countries.
- ODVA, CIP, CompoNet, DeviceNet, and EtherNet/IP are trademarks of ODVA.

Other company names and product names in this document are the trademarks or registered trademarks of their respective companies.

Copyrights

Microsoft product screen shots reprinted with permission from Microsoft Corporation.

DeviceNet Safety System Configuration Manual

Revised October 2022

Notice:

OMRON products are manufactured for use according to proper procedures by a qualified operator and only for the purposes described in this manual.

The following conventions are used to indicate and classify precautions in this manual. Always heed the information provided with them. Failure to heed precautions can result in injury to people or damage to property.

 **WARNING** Indicates a potentially hazardous situation which, if not avoided, will result in minor or moderate injury, or may result in serious injury or death. Additionally, there may be significant property damage.



Indicates general prohibitions for which there is no specific symbol.



Indicates general mandatory actions for which there is no specific symbol.

OMRON Product References

All OMRON products are capitalized in this manual. The word “Unit” is also capitalized when it refers to an OMRON product, regardless of whether or not it appears in the proper name of the product.

The abbreviation “PLC” means Programmable Controller.

Visual Aids

The following headings appear in the left column of the manual to help you locate different types of information.

IMPORTANT Indicates important information on what to do or not to do to prevent failure to operation, malfunction, or undesirable effects on product performance.

Note Indicates information of particular interest for efficient and convenient operation of the product.

1,2,3... 1. Indicates lists of one sort or another, such as procedures, checklists, etc.

TABLE OF CONTENTS

PRECAUTIONS	xv
1 Intended Audience	xvi
2 General Precautions	xvi
3 Safety Precautions	xviii
4 Precautions for Safe Use	xix
SECTION 1	
Overview	1
1-1 DeviceNet Safety System Overview	2
1-2 Safety Network Controller Overview	3
1-3 Network Configurator Overview	7
1-4 Basic System Startup Procedure	10
SECTION 2	
Constructing a Safety Network	13
2-1 Applications	14
2-2 Allocating Network Bandwidth Usage and Calculating the Best EPI	21
2-3 Calculating and Verifying the Reaction Time	31
SECTION 3	
Basic Operation of the Network Configurator	37
3-1 Installation	39
3-2 Network Configurator Startup and Main Window	49
3-3 Menu List	52
3-4 Connecting to the Network	62
3-5 Creating a Virtual Network	68
3-6 Saving and Reading Network Configuration Files	79
3-7 Device Password Protection	82
3-8 Device Parameters and Properties	84
3-9 Parameter Verification	92
3-10 Configuration Lock	96
3-11 Device Reset and Status Change	98
SECTION 4	
Editing Safety I/O Terminal Parameters	103
4-1 Editing Parameters	104
4-2 Editing Parameters for Logic Terminals (DST1-XD0808SL-1)	117

TABLE OF CONTENTS

SECTION 5

Editing Safety Network Controller Parameters. 131

5-1	Safety Connection Settings	132
5-2	Safety Slave Settings	143
5-3	Standard Slave Settings	150
5-4	Setting the Controller as an EtherNet/IP Standard Target	153
5-5	Local I/O Settings	156
5-6	Setting the Operating Mode and Confirming the Cycle Time	165
5-7	Extend Mode Settings	169
5-8	Setting Maintenance Information	171
5-9	Displaying Memory Information	172

SECTION 6

Programming the Safety Network Controller 173

6-1	Starting and Exiting the Logic Editor	174
6-2	Menu Commands	176
6-3	Programming	179

SECTION 7

Monitoring Devices 217

7-1	Monitoring Functions	218
7-2	Maintenance Functions (Unit Version 1.0 or Later)	227
7-3	Displaying Safety Device Status	233

SECTION 8

Troubleshooting 235

8-1	Connection Status Tables	236
8-2	Errors When Downloading	241
8-3	Errors When Resetting	244
8-4	Errors When Changing Modes	245
8-5	Errors That Can Be Found Using the Connection Check Function	246

SECTION 9

Maintenance Tool 249

9-1	Overview of Maintenance Tool	250
9-2	Starting and Exiting the Maintenance Tool and Version Information	253
9-3	Screen Names and Functions	255
9-4	Setting the Monitor Refresh Time	257
9-5	Basic Online Operations	258
9-6	Reading Device Information	263
9-7	Replacing a Device	270
9-8	Uploading to Individual Devices	274
9-9	Downloading for Individual Devices	276

TABLE OF CONTENTS

9-10 Uploading (Network)	280
9-11 Downloading (Network)	282
9-12 Resetting a Device	285
9-13 Changing the Mode	288
9-14 Locking/Unlocking Devices	290
9-15 Change Passwords	292
Appendices	293
Glossary	349
Index	351
Revision History	355

TABLE OF CONTENTS

About this Manual:

This manual describes the configuration of the DeviceNet Safety system.

Please read this manual carefully and be sure you understand the information provided before attempting to configure a DeviceNet Safety system. Be sure to read the precautions provided in the following section.

The following manuals provide information on the DeviceNet and DeviceNet Safety.

DeviceNet Safety System Configuration Manual (this manual) (Z905)

This manual explains how to configure the DeviceNet Safety system using the Network Configurator.

DeviceNet Safety NE1A Series Safety Network Controller Operation Manual (Z906)

This manual describes the specifications, functions, and usage of the NE1A-series Controllers.

DeviceNet Safety I/O Terminal Operation Manual (Z904)

This manual describes the specifications, functions, and usage of the DST1 series.

DeviceNet Operation Manual (W267)

This manual describes the construction and connection of a DeviceNet network. It provides detailed information on the installation and specifications of cables, connectors, and other peripheral equipment used in the network, and on the supply of communications power. Obtain this manual and gain a firm understanding of its contents before using a DeviceNet system.

DeviceNet Safety Logic Simulator Operation Manual (Z910)

This manual describes the functions and operating procedures of the NE1A Logic Simulator.

DeviceNet Safety NE0A-series Safety Network Controller Operation Manual (Z916)

This manual describes the models, specifications, functions, and operating procedures of the NE0A-series Safety Network Controllers.



WARNING Failure to read and understand the information provided in this manual may result in personal injury or death, damage to the product, or product failure. Please read each section in its entirety and be sure you understand the information provided in the section and related sections before attempting any of the procedures or operations given.

Terms and Conditions Agreement

WARRANTY

- The warranty period for the Software is one year from the date of purchase, unless otherwise specifically agreed.
- If the User discovers defect of the Software (substantial non-conformity with the manual), and return it to OMRON within the above warranty period, OMRON will replace the Software without charge by offering media or download from OMRON's website. And if the User discovers defect of media which is attributable to OMRON and return it to OMRON within the above warranty period, OMRON will replace defective media without charge. If OMRON is unable to replace defective media or correct the Software, the liability of OMRON and the User's remedy shall be limited to the refund of the license fee paid to OMRON for the Software.

LIMITATION OF LIABILITY

- THE ABOVE WARRANTY SHALL CONSTITUTE THE USER'S SOLE AND EXCLUSIVE REMEDIES AGAINST OMRON AND THERE ARE NO OTHER WARRANTIES, EXPRESSED OR IMPLIED, INCLUDING BUT NOT LIMITED TO, WARRANTY OF MERCHANTABILITY OR FITNESS FOR PARTICULAR PURPOSE. IN NO EVENT, OMRON WILL BE LIABLE FOR ANY LOST PROFITS OR OTHER INDIRECT, INCIDENTAL, SPECIAL OR CONSEQUENTIAL DAMAGES ARISING OUT OF USE OF THE SOFTWARE.
- OMRON SHALL HAVE NO LIABILITY FOR DEFECT OF THE SOFTWARE BASED ON MODIFICATION OR ALTERNATION TO THE SOFTWARE BY THE USER OR ANY THIRD PARTY.
- OMRON SHALL HAVE NO LIABILITY FOR SOFTWARE DEVELOPED BY THE USER OR ANY THIRD PARTY BASED ON THE SOFTWARE OR ANY CONSEQUENCE THEREOF.

APPLICABLE CONDITIONS

USER SHALL NOT USE THE SOFTWARE FOR THE PURPOSE THAT IS NOT PROVIDED IN THE ATTACHED USER MANUAL.

CHANGE IN SPECIFICATION

The software specifications and accessories may be changed at any time based on improvements and other reasons.

ERRORS AND OMISSIONS

The information in this manual has been carefully checked and is believed to be accurate; however, no responsibility is assumed for clerical, typographical, or proofreading errors, or omissions.

PRECAUTIONS

1	Intended Audience	xvi
2	General Precautions	xvi
3	Safety Precautions	xviii
4	Precautions for Safe Use	xix

1 Intended Audience

This manual is intended for the following personnel, who must have knowledge of electrical systems (an electrical engineer or the equivalent).

- Personnel in charge of introducing FA and safety systems into production facilities
- Personnel in charge of designing FA and safety systems
- Personnel in charge of managing FA facilities
- Personnel who have the qualifications, authority, and obligation to provide safety during each of the following product phases: mechanical design, installation, operation, maintenance, and disposal

2 General Precautions

The user must operate the product according to the performance specifications described in the operation manuals.

Before using the product under conditions which are not described in the manual or applying the product to nuclear control systems, railroad systems, aviation systems, vehicles, combustion systems, medical equipment, amusement machines, safety equipment, and other systems, machines, and equipment that may have a serious influence on lives and property if used improperly, consult your OMRON representative.

Make sure that the ratings and performance characteristics of the product are sufficient for the systems, machines, and equipment, and be sure to provide the systems, machines, and equipment with double safety mechanisms.

This manual provides information for programming and operating the Unit. Be sure to read this manual before attempting to use the Unit and keep this manual close at hand for reference during operation.

 **WARNING** This is the *System Configuration Manual* for DeviceNet Safety Systems. Heed the following items during system construction to ensure that safety-related components are configured in a manner that allows the system functions to operate sufficiently.

• Risk Assessment

The proper use of safety devices described in this Manual as it relates to installation conditions and mechanical performance and functions is a prerequisite for their use. When selecting or using a safety device, risk assessment must be conducted with the aim of identifying potential danger factors in equipment or facilities in which the safety device is to be applied, during the development stage of the equipment or facilities. Suitable safety devices must be selected under the guidance of a sufficient risk assessment system. An insufficient risk assessment system may lead to the selection of unsuitable safety devices.

- Typical related international standards: ISO 14121, Safety of Machinery -- Principles of Risk Assessment

• Safety Measures

When using safety devices to build systems containing safety-related components for equipment or facilities, the system must be designed with the full understanding of and conformance to international standards, such as those listed below, and/or standards in related industries.

- Typical related international standards: ISO/DIS 12100, Safety of Machinery -- Basic Concepts and General Principles for Design IEC 61508, Safety Standard for Safety Instrumented Systems (Functional Safety of Electrical/Electronic/Programmable Electronic Safety-related Systems)

- **Role of Safety Device**

The safety devices are provided with safety functions and mechanisms as stipulated in relevant standards, but suitable designs must be used to allow these functions and mechanisms to operate properly inside system constructions containing safety-related components. Build systems that enable these functions and mechanisms to perform properly, based on a full understanding of their operation.

- Typical related international standards: ISO 14119, Safety of Machinery -- Interlocking Devices Associated with Guards -- Principles of Design and Selection

- **Installation of Safety Device**

The construction and installation of systems with safety-related components for equipment or facilities must be performed by technicians who have received suitable training.

- Typical related international standards: ISO/DIS 12100, Safety of Machinery -- Basic Concepts and General Principles for Design IEC 61508, Safety Standard for Safety Instrumented Systems (Functional Safety of Electrical/Electronic/Programmable Electronic Safety-related Systems)

- **Complying with Laws and Regulations**

The safety devices conform to the relevant regulations and standards, but make sure that they are used in compliance with local regulations and standards for the equipment or facilities in which they are applied.

- Typical related international standards: IEC 60204, Safety of Machinery -- Electrical Equipment of Machines

- **Observing Precautions for Use**

















When putting the selected safety devices to actual use, heed the specifications and precautions in this Manual and those in the Operation Manuals that comes with the products. Using the products in a manner that deviates from these specifications and precautions will lead to unexpected failures in equipment or devices, and to damages that result from such failures, due to insufficient operating functions in safety-related components.





- **Moving or Transferring Devices or Equipment**

When moving or transferring devices or equipment, be sure to include this Manual to ensure that the person to whom the device or equipment is being moved or transferred will be able to operate the system properly.

- Typical related international standards: ISO/DIS 12100 ISO, Safety of Machinery -- Basic Concepts and General Principles for Design IEC 61508, Safety Standard for Safety Instrumented Systems (Functional Safety of Electrical/Electronic/Programmable Electronic Safety-related Systems)

3 Safety Precautions

 WARNING	
Safety functions may be impaired and serious injury may occasionally occur. Do not use the test outputs of the products as safety outputs.	
Serious injury may possibly occur due to loss of required safety functions. Do not use non-safety data as safety signals.	
Serious injury may possibly occur due to loss of required safety functions. Do not use DeviceNet standard I/O data, EtherNet/IP standard I/O data, UDP/IP message data, or explicit message data as safety signals.	
Safety functions may be impaired and serious injury may occasionally occur. Do not use the indicators on the products for safety operations.	
Serious injury may possibly occur due to breakdown of safety outputs or test outputs. Do not connect loads beyond the rated value to the safety outputs or test outputs.	
Safety functions may be impaired and serious injury may occasionally occur. Wire the output lines and 24-VDC line so that they will not touch each other to prevent a load from turning ON due to a short-circuit with the 24-VDC line.	
Safety functions may be impaired and serious injury may occasionally occur. Ground the 0-V side of the external power supply to prevent an output from turning ON due to a ground fault in a safety output or test output.	
Safety functions may be impaired, and serious injury may occasionally occur. Before connecting a device to the network, clear the previous configuration data.	
Safety functions may be impaired and serious injury may occasionally occur. Before connecting a device to the network, configure the appropriate node address and the baud rate.	
Safety functions may be impaired and serious injury may occasionally occur. Before operating the system, conduct user testing to confirm if the configuration data of all the devices and their operations are correct.	
Safety functions may be impaired, and serious injury may occasionally occur. When replacing a device, confirm that the replacement device is appropriately configured and operates properly.	
Serious injury may possibly occur due to loss of required safety functions. Use appropriate components or devices according to the requirements given in the following table.	
To prevent computer viruses, install antivirus software on a computer where you use this software. Make sure to keep the antivirus software updated.	
Keep your computer's OS updated to avoid security risks caused by a vulnerability in the OS.	
Always use the highest version of this software to add new features, increase operability, and enhance security.	

 WARNING	
Manage usernames and passwords for this software carefully to protect them from unauthorized uses.	
Set up a firewall (E.g., disabling unused communication ports, limiting communication hosts, etc.) on a network for a control system and devices to separate them from other IT networks. Make sure to connect to the control system inside the firewall.	
Use a virtual private network (VPN) for remote access to a control system and devices from this software.	

Control device	Requirements
Emergency stop switch	Use approved devices with a direct opening mechanism compliant with IEC/EN 60947-5-1.
Door interlocking switch or limit switch	Use approved devices with a direct opening mechanism compliant with IEC/EN 60947-5-1 and capable of switching micro-loads of 4 mA at 24 VDC.
Safety sensor	Use approved devices compliant with the relevant product standards, regulations, and rules in the country where they are used.
Relay with forcibly guided contacts	Use approved devices with forcibly guided contacts compliant with EN 50205. For feedback, use devices with contacts capable of switching micro-loads of 4 mA at 24 VDC.
Contactors	Use contactors with a forcibly guided mechanism and monitor the auxiliary NC contact to detect contactor failures. For feedback, use devices with contacts capable of switching micro-loads of 4 mA at 24 VDC.
Other devices	Evaluate whether devices used are appropriate to satisfy the requirements of the safety category level.

4 Precautions for Safe Use

■ Handling

Do not drop the products or subject them to excessive vibration or impact. Doing so may result in error or malfunction.

■ Installation and Storage

Do not install or store the products in the following locations:

- Locations subject to direct sunlight
- Locations subject to temperatures or humidity outside the range specified in the specifications
- Locations subject to condensation as the result of severe changes in temperature
- Locations subject to corrosive or flammable gases
- Locations subject to dust (especially iron dust) or salts
- Locations subject to water, oil, or chemicals
- Locations subject to shock or vibration outside the range specified in the specifications

Take appropriate and sufficient measures when installing systems in the following locations. Inappropriate and insufficient measures may result in malfunction.

- Locations subject to static electricity or other forms of noise
- Locations subject to strong electromagnetic fields
- Locations subject to possible exposure to radioactivity

- Locations close to power supplies

■ Mounting

Confirm the operating suggestions provided in the operation manual for each product before installation and mounting.

■ Wiring

- Use the following wires to connect external I/O devices to the products.

Solid wire	0.2 to 2.5 mm ² (AWG 24 to AWG 12)
Stranded (flexible) wire	0.34 to 1.5 mm ² (AWG 22 to AWG 16) Stranded wires should be prepared by attaching ferrules with plastic insulation collars (DIN 46228-4 standard compatible) before connecting them.

- Turn OFF the power supply before starting any wiring operations. Not doing so may result in unexpected operation of external devices connected to the products.
- Properly apply the specified voltage to the product inputs. Applying an inappropriate DC voltage or any AC voltage may cause reduced safety functions, damage to the products, or a fire.
- Do not wire cables for communications and I/O signals near high-voltage lines or power lines.
- Be careful not to get your fingers caught when attaching connectors to the plugs on the products.
- Tighten the DeviceNet connector to the appropriate torque (0.25 to 0.3 N·m).
- Incorrect wiring may reduce safety functions. Perform all wiring correctly and check operation prior to using the products.
- Remove the dust-preventive label after completing wiring to ensure proper heat dissipation.

■ Selecting a Power Supply

Use a DC power supply satisfying the following requirements.

- The secondary circuits of the DC power supply must be isolated from the primary circuit by double insulation or reinforced insulation.
- The DC power supply must satisfy the requirements for class 2 circuits or limited voltage/current circuits defined in UL 508.
- The output hold time must be 20 ms or longer.

■ Periodic Inspections and Maintenance

- Turn OFF the power supply before replacing the products. Not doing so may result in unexpected operation of external devices connected to the products.
- Do not disassemble, repair, or modify the products. Doing so may impair the safety functions.

■ Disposal

- If you disassemble the products for disposal, be careful not to injure yourself.

Network Configurator Version Upgrade

Upgrade from Version 1.6□ to Version 3.4□

The WS02-CFSC1-E, WS02-CFSC1-EV□ Network Configurator has been upgraded from version to 3.3□. The following changes have been made in line with the upgrade.

Item	Ver. 1.6□	Ver. 2.00	Ver. 2.01	Ver. 2.1□	Ver. 2.2□	Ver. 3.3□	Ver. 3.4□
Supported Devices Added							
NE1A-EDR01	---	Supported	Supported	Supported	Supported	Supported	Supported
NE0A-SCPU01	---	---	---	Supported	Supported	Supported	Supported
Network Setting Function							
Support for multiple networks in the same file	---	Supported	Supported	Supported	Supported	Supported	Supported
I/O Parameter Wizard	---	Supported	Supported	Supported	Supported	Supported	Supported
Configuration checking when downloading to networks	---	Supported	Supported	Supported	Supported	Supported	Supported
Batch mode changes for multiple devices	---	Supported	Supported	Supported	Supported	Supported	Supported
Batch verification for multiple devices	---	Supported	Supported	Supported	Supported	Supported	Supported
Batch registration to Safety Master	---	Supported	Supported	Supported	Supported	Supported	Supported
Switching the display between expansion and standard parameters on DST1-series setting displays	---	Supported	Supported	Supported	Supported	Supported	Supported
Connection replacement	---	Supported	Supported	Supported	Supported	Supported	Supported
I/O connection batch replacement	---	Supported	Supported	Supported	Supported	Supported	Supported
Device connection configuration display	---	Supported	Supported	Supported	Supported	Supported	Supported
Saving and reading design data for individual networks in files	---	---	Supported	Supported	Supported	Supported	Supported
Moving network tabs	---	---	Supported	Supported	Supported	Supported	Supported
Assembly details	---	---	---	---	---	Supported	Supported
Displaying network bandwidth usage	Safety	Safety	Safety	Safety	Safety	Safety + Standard	Safety + Standard
Programming Functions							
Automatic update of the user-defined function blocks	---	Supported	Supported	Supported	Supported	Supported	Supported
Setting parameters used in user-defined function blocks	---	Supported	Supported	Supported	Supported	Supported	Supported
Moving and saving connection positions	---	Supported	Supported	Supported	Supported	Supported	Supported
Improved method for changing the number of function block I/O	---	Supported	Supported	Supported	Supported	Supported	Supported
Copying and pasting between different programs	---	Supported	Supported	Supported	Supported	Supported	Supported
Page name printing at program printing	---	---	Supported	Supported	Supported	Supported	Supported
Globally changing time parameters for function blocks	---	---	---	---	---	Supported	Supported

Item	Ver. 1.6□	Ver. 2.00	Ver. 2.01	Ver. 2.1□	Ver. 2.2□	Ver. 3.3□	Ver. 3.4□
Other Functions							
Applicable OS	Windows 2000 Windows XP	Windows 2000 Windows XP	Windows 2000 Windows XP	Windows 2000 Windows XP	Windows 2000 Windows XP Windows Vista (32-bit version only)	Windows XP Windows Vista (32-bit/64-bit) Windows 7 (32-bit/64-bit)	Windows XP SP3 (32-bit) Windows Vista SP2 (32-bit/64-bit) Windows 7 (32-bit/64-bit) Windows 8 (32-bit/64-bit) Windows 8.1 (32-bit/64-bit) Windows 10 (32-bit/64-bit)
File extension for project files	ncf	ncf	ncf	ncf	ncf	nvf	nvf
Changes to restrictions when a network configuration file is opened in Protect Mode (Downloading (when changing parameters), resetting, locking and unlocking, and changing modes are supported.)	---	---	---	---	Supported	Supported	Supported
Batch saving of device parameter files with multiple devices selected	---	---	---	---	Supported	Supported	Supported
Displaying countermeasures in the error history monitor	---	---	---	---	Supported	Supported	Supported

Unit Versions of NE1A-series Controllers

Checking the Unit Version

A “unit version” has been introduced to manage NE1A-series Safety Network Controllers according to differences in functionality accompanying Unit upgrades, even though the model numbers are the same.

The unit version can be checked on the product itself or using the Network Configurator.

Note The Network Configurator maintains a revision number to manage device functions for DeviceNet and EtherNet/IP. Refer to “Checking the Unit Version with the Network Configurator” on page xxiii for the relationship between NE1A-series Controller unit versions and the revisions.

Checking the Unit Version on the Product Nameplate

The unit version (Ver. □.□) is listed near the lot number on the nameplate of the products for which unit versions are being managed, as shown below.

- The unit versions of the NE1A-SCPU01-V1, NE1A-SCPU02, NE1A-SCPU01-EIP, and NE1A-SCPU02-EIP Controllers begin from Ver. 1.0.
- Controllers that do not have a unit version listed on the label are called Pre-Ver. 1.0 Controllers.

Product Nameplate

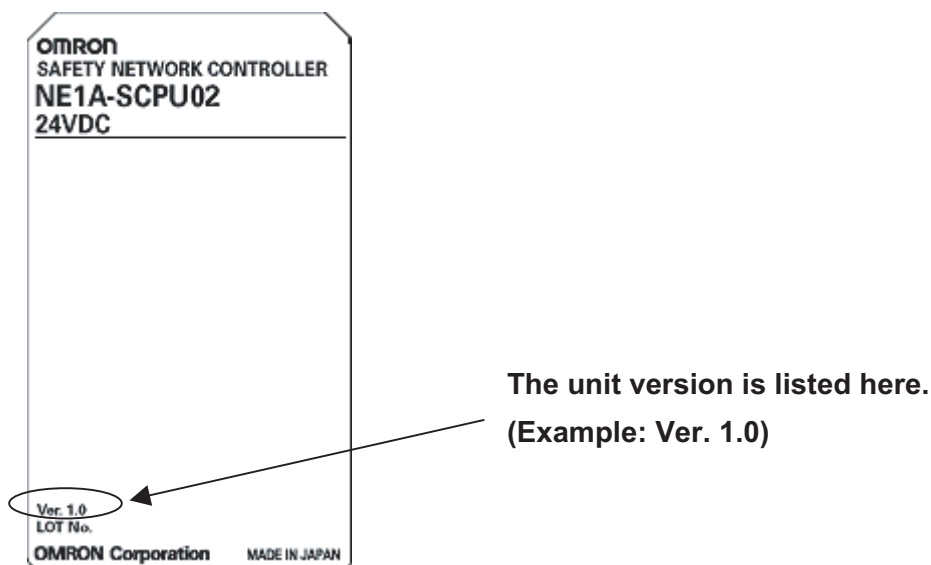

Checking the Unit Version with the Network Configurator

The following procedure can be used to check the unit version from the Network Configurator Ver. 1.6 or higher.

1. Select **Upload** from the Network Menu to upload the configuration information.

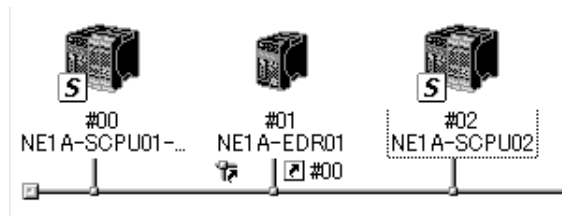

- Right-click on the Controller's icon to display the popup menu shown below.
Select **Property** from the menu.

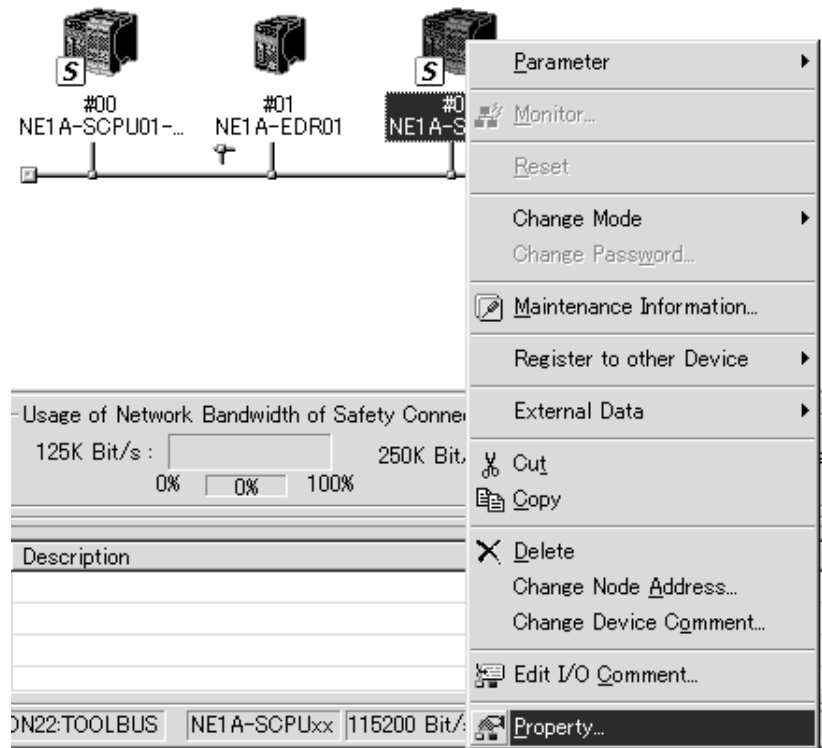

The Controller's Property Window will be displayed.

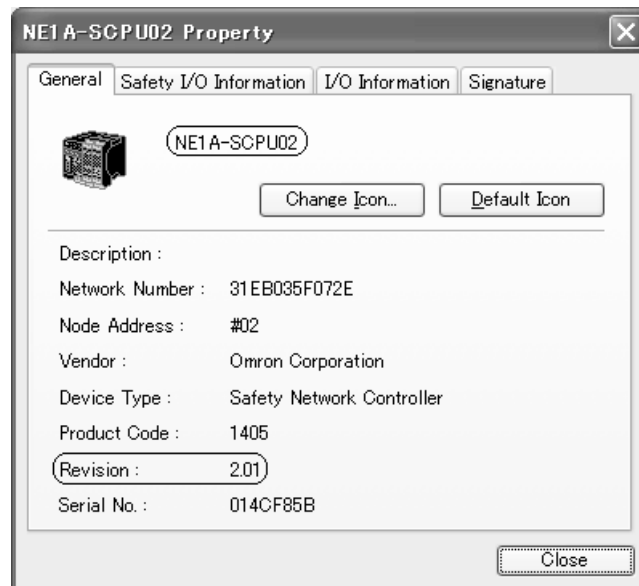

The Controller's model number (device name) and revision are displayed in the Property Window. The NE1A-series Controllers supported by Network Configurator are listed in the following table.

- CPU Units without EtherNet/IP

Model	Device name	Revision	Unit version
NE1A-SCPU01	NE1A-SCPU01	1.01	Pre-Ver. 1.0
NE1A-SCPU01-V1	NE1A-SCPU01-V1	1.0□	1.0
NE1A-SCPU01-V1	NE1A-SCPU01-V1	2.0□	2.0
NE1A-SCPU02	NE1A-SCPU02	1.0□	1.0
NE1A-SCPU02	NE1A-SCPU02	2.0□	2.0

- CPU Units with EtherNet/IP

Model	Device name	Revision	Unit version
NE1A-SCPU01-EIP	NE1A-SCPU01-EIP	1.01	1.0
NE1A-SCPU01-EIP	NE1A-SCPU01-EIP	1.02	1.1
NE1A-SCPU02-EIP	NE1A-SCPU02-EIP	1.01	1.0
NE1A-SCPU02-EIP	NE1A-SCPU02-EIP	1.02	1.1

Checking the Unit Version on the Product Nameplate

The following unit version labels are provided with the Controller.



These labels can be attached to the front of the Controllers to differentiate between Controllers with different unit versions from the front of the Controller.

Function Support by Unit Version

Model	NE1A-SCPU01	NE1A-SCPU01-V1	NE1A-SCPU02	NE1A-SCPU01-EIP	NE1A-SCPU02-EIP
Function	Unit version	Pre-Ver. 1.0	Ver. 1.0/Ver. 2.0	Ver. 1.0/Ver. 1.1	Ver. 1.0/Ver. 1.1
Logic operations					
Maximum program size (total number of function blocks)	128	254	254	254	254
Added function blocks • RS Flip-flop • Multi Connector • Muting • Enable Switch • Pulse Generator • Counter • Comparator	---	Supported	Supported	Supported	Supported
Selection of the rising edge of the reset condition for the Reset and Restart Function Blocks	---	Supported	Supported	Supported	Supported
Use local I/O status in logic programming	---	Supported	Supported	Supported	Supported
Use the Unit's general status in logic programming	---	Supported	Supported	Supported	Supported
Program execution delay	---	Supported (unit version 2.0 or later)	Supported (unit version 2.0 or later)	Supported	Supported
I/O control functions					
Contact Operation Counter	---	Supported	Supported	Supported	Supported
Total ON Time Monitor	---	Supported	Supported	Supported	Supported
DeviceNet communications functions					
Number of safety I/O connections at the Safety Master	16	32	32	32	32
Selection of operation of safety I/O communications after a communications error	---	Supported	Supported	Supported	Supported
Add local output status to send data during Slave operation.	---	Supported	Supported	Supported	Supported
Add local input monitoring to send data during Slave operation.	---	Supported	Supported	Supported	Supported
Communications with devices on other networks (off-link connections)	---	Supported (Unit version 2.0 or later)	Supported (Unit version 2.0 or later)	Supported	Supported
Functions supporting system startup and error recovery					
Saving non-fatal error history in non-volatile memory	---	Supported	Supported	Supported	Supported
Added function block errors to error history.	---	Supported	Supported	Supported	Supported
EtherNet/IP communications					
I/O communications	---	---	---	Supported	Supported
Message communications	---	---	---	Supported	Supported
Reading and writing target I/O areas	---	---	---	Supported (unit version 1.1 or later)	Supported (unit version 1.1 or later)

Model	NE1A-SCPU01	NE1A-SCPU01-V1	NE1A-SCPU02	NE1A-SCPU01-EIP	NE1A-SCPU02-EIP
Unit version	Pre-Ver. 1.0	Ver. 1.0/Ver. 2.0	Ver. 1.0/Ver. 2.0	Ver. 1.0/Ver. 1.1	Ver. 1.0/Ver. 1.1
Function					
Routing between DeviceNet and EtherNet/IP					
I/O routing	---	---	---	Supported	Supported
Message routing	---	---	---	Supported	Supported
UDP/IP message communications					
UDP/IP message communications	---	---	---	Supported (unit version 1.1 or later)	Supported (unit version 1.1 or later)

Unit Versions and Programming Devices

Network Configurator version 2.0□ or higher must be used when using a NE1A-SCPU01-V1 or NE1A-SCPU02 Safety Logic Controller with unit version 2.0.

Network Configurator version 2.2□ or higher must be used when using a NE1A-SCPU01-EIP or NE1A-SCPU02-EIP Safety Logic Controller with unit version 1.0.

Network Configurator version 3.3□ or higher must be used when using a NE1A-SCPU01-EIP or NE1A-SCPU02-EIP Safety Logic Controller with unit version 1.1.

The following table shows the relationship between unit versions and Network Configurator versions.

Model number	Network Configurator					
	Ver. 1.3□	Ver. 1.5□	Ver. 1.6□	Ver. 2.0□/ 2.1□	Ver. 2.2□	Version 3.3□ or higher
NE1A-SCPU01 Pre-Ver. 1.0	Can be used.	Can be used.	Can be used.	Can be used.	Can be used.	Can be used.
NE1A-SCPU01-V1 Unit Ver. 1.0	Cannot be used.	Cannot be used.	Can be used.	Can be used.	Can be used.	Can be used.
NE1A-SCPU02 Unit Ver. 1.0	Cannot be used.	Cannot be used.	Can be used.	Can be used.	Can be used.	Can be used.
NE1A-SCPU01-V1 Unit Ver.2.0	Cannot be used.	Cannot be used.	Can be used. (See note 1.)	Can be used.	Can be used.	Can be used.
NE1A-SCPU02 Unit Ver.2.0	Cannot be used.	Cannot be used.	Can be used. (See note 1.)	Can be used.	Can be used.	Can be used.
NE1A-SCPU01-EIP Unit Ver. 1.0	Cannot be used.	Cannot be used.	Cannot be used.	Cannot be used.	Can be used.	Can be used.
NE1A-SCPU02-EIP Unit Ver. 1.0	Cannot be used.	Cannot be used.	Cannot be used.	Cannot be used.	Cannot be used.	Can be used.
NE1A-SCPU01-EIP Unit Ver. 1.1	Cannot be used.	Cannot be used.	Cannot be used.	Cannot be used.	Can be used. (See note 1.)	Can be used.
NE1A-SCPU02-EIP Unit Ver. 1.1	Cannot be used.	Cannot be used.	Cannot be used.	Cannot be used.	Can be used. (See note 1.)	Can be used.

- Note**
- (1) Can be used as a Controller with unit version 1.0.
 - (2) Network Configurator version 1.5□ or lower can be upgraded to version 1.6□ free of charge.
 - (3) When using Network Configurator version 1.6□, there are no operational differences in the NE1A-SCPU01-V1 and NE1A-SCPU02 Safety Logic Controllers that derive from the unit version.

Unit Versions and Configuration Data

The following table shows the relationship between unit versions of NE1A-series Controllers in network configuration files created with Network Configurator and the unit version of NE1A-series Controllers to which configuration files are downloaded.

Unit versions of NE1A-series Controllers in Network configuration files created with Network Configurator	NE1A-series Controller to which configuration file is downloaded			
	Pre-Ver. 1.0 CPU Unit	CPU Unit with unit version 1.0	CPU Unit with unit version 2.0	CPU Unit with unit version 1.0/1.1 that supports EtherNet/IP
Pre-Ver. 1.0 CPU Unit	Downloading is possible.	Not possible. (See note 1.)	Not possible. (See note 1.)	Not possible. (See note 1.)
CPU Unit with unit version 1.0 that does not support EtherNet/IP	Not possible.	Downloading is possible.	Downloading is possible. (See note 2.)	Not possible. (See note 1.)
CPU Unit with unit version 2.0	Not possible.	Not possible.	Downloading is possible.	Not possible. (See note 1.)
CPU Unit with unit version 1.0/1.1 that supports EtherNet/IP	Not possible.	Not possible.	Not possible.	Downloading is possible.

Note (1) Downloading is possible if the device type is changed using the function provided in Network Configurator. For details, refer to “Converting Systems to New Versions of the NE1A Controller” on page xxix.

(2) Only functions CPU Units with unit version 1.0 can be used.

Note The Configuration data created with unit version 1.0 can be downloaded to a NE1A-series Controller with unit version 2.0. The data will be subsequently treated as unit version 2.0 data if it is uploaded.

Converting Systems to New Versions of the NE1A Controller

Functions are added and functionality is expanded in various ways for the NE1A-series Controllers. The device type in an existing network configuration file can be changed to a higher version so that the new functionality can be used.

The following table shows the NE1A-series Control device types in network configuration files and the device types that they can be upgraded to.

Device type before change	Device type after change					
	NE1A-SCPU01-V1		NE1A-SCPU02		NE1A-SCPU01-EIP	NE1A-SCPU02-EIP
	Unit Ver. 1.0	Unit Ver. 2.0	Unit Ver. 1.0	Unit Ver. 2.0	Unit Ver. 1.0/1.1	Unit Ver. 1.0/1.1
NE1A-SCPU01 Pre-Ver. 1.0	OK	OK	OK	OK	OK	OK
NE1A-SCPU01-V1 Unit Ver. 1.0	---	OK	OK	OK	OK	OK
NE1A-SCPU01-V1 Unit Ver. 2.0	OK*	---	Not possible	OK	OK	OK
NE1A-SCPU02 Unit Ver. 1.0	Not possible	Not possible	---	OK	Not possible	OK
NE1A-SCPU02 Unit Ver. 2.0	Not possible	Not possible	OK*	---	Not possible	OK
NE1A-SCPU01-EIP Unit Ver. 1.0/1.1	Not possible	Not possible	Not possible	Not possible	---	OK
NE1A-SCPU02-EIP Unit Ver. 1.0/1.1	Not possible	Not possible	Not possible	Not possible	Not possible	---

*Conversion is possible, but off-link connection settings are not retained.

1. Read the configuration data.

Use the following procedure to read the configuration data with Network Configurator version 1.6 or higher.

- Read configuration data that has been saved on the computer.
- Upload the configuration data from the network devices.

The display should appear as follows after then data has been read:

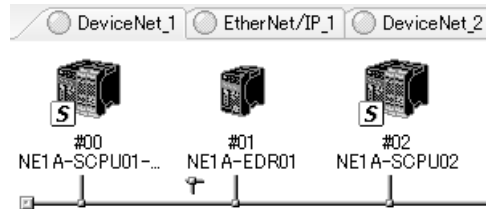

2. Convert the configuration data.

In the data that was read with the Network Configurator, select the NE1A-series Controller to convert to a higher version. Right-click and select **Change Device Type** from the pop-up menu.

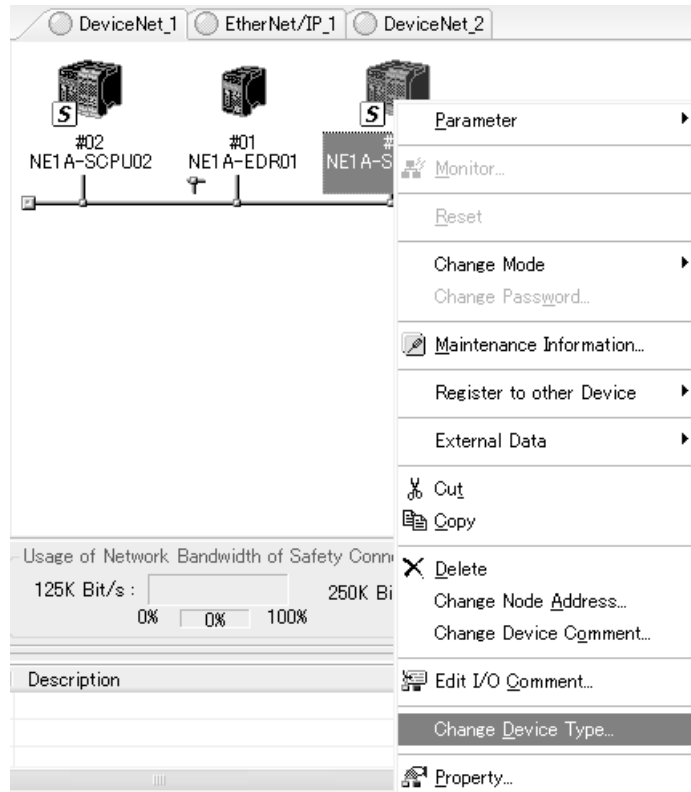

Select the device to which the data is to be converted in the *New Device* Field and click the **OK** Button.



The data will be converted to configuration data for the new devices and the model given on the display will change.

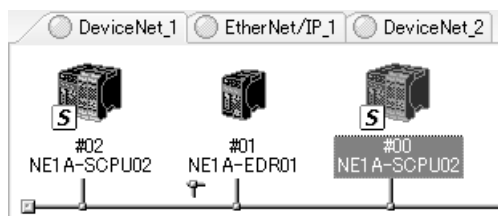

3. Expansion Functions

All the configuration data for the expansion functions will be set to the default settings. Change these settings as required for any expansion functions that are to be used.

- Note**
- (1) When changing the device type using Network Configurator version 1.6□, open the Edit Device Parameters Dialog Box of the Controller, select a connection on the *Safety Connection* Tab Page, and click the **Update** Button.
 - (2) When changing the device type using Network Configurator version 2.□ or higher, the connection information will be updated automatically.
 - (3) Data cannot be converted to data for lower versions.

Precautions Updating from Network Configurator Version 1.3□ to a Higher Version

Data Compatibility

Data created using Network Configurator version 1.3□ can be used with a higher version without any problems if converted as outlined below. Data created with higher versions cannot be used with lower versions; the data upload from the device will fail when loading the project file.

Procedure for Converting Data from Version 1.3□ to a Higher Version

Version 1.5□ and higher have improved safety check functions, so version programs from lower versions will need to be checked for safety. Use the following procedure to check programs.

- a. Click the **Logic** Tab on the Edit Device Parameters Window of the NE1A-series Controller and click the **Edit** Button to start the Logic Editor.
- b. Select **Edit - Find Function Blocks with Open Connections** to check that all function block I/O have connections.
- c. Select **File - Apply** to save the logic program then exit the editing of the logic program.
- d. Return to the NE1A-series Controller's Edit Device Parameters Window and click the **OK** Button.

Note Data created using version 1.3□ cannot be monitored online. Always convert the data to version 1.5□ and download it before monitoring online.

Handling Function Blocks with Open I/O Connections

Function block outputs with open connections in version 1.3□ data could still be downloaded (see following diagram).

Download cannot be executed with version 1.5□ or higher, however, if there are outputs with open connections (to improve the program validity).

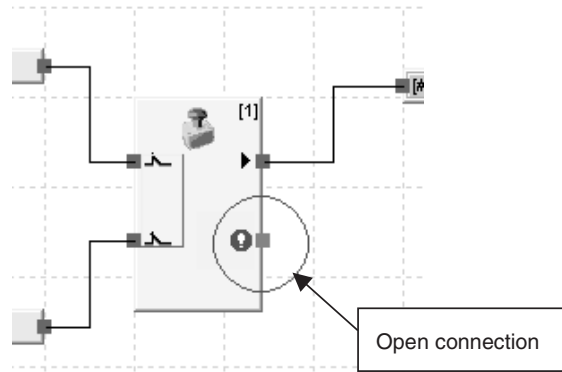

For this reason, data created using version 1.3□ cannot be downloaded as is for use with version 1.5□ or higher. If open connections exist in version 1.3□ data, use the Search Open Connection function and use the Set Output Point Tab Page in the Safety Gate Monitoring Window for the function block with open connections to disable the outputs or connect the open connections to output I/O tags.

Note Versions 1.5□ and higher have functions for creating text boxes on program screens and changing the I/O tag color. The text box and I/O color data is not saved to the NE1A-series Controller, however, during download. For this reason, text box and I/O tag color data is not restored when the program is uploaded.

Precautions when Updating from Network Configurator Version 2.2□ or Lower to Version 3.3□ or Higher

Supported Operating Systems

Operation on Windows 2000 is not supported for version 3.3□ or higher.

Data Compatibility

The project file formats are different for version 2.2□ or lower and version 3.3□ or higher. With version 3.3 or higher, the same Network Configurator v3 network configuration files as the Network Configurator that is included in the CX-One are used. The differences between these two project file formats are given below.

Project File Differences

Name	Network Configurator v2 Files	Network Configurator v3 Files
Extension	ncf	nvf
Network numbers for EtherNet/IP networks	Not saved.	Saved.

Network Configuration v1/v2 files that were created on Network Configurator version 2.□ or lower can be used as is on Network Configurator version 3.3□ or higher. If a v2 file is saved (**File – Save**), it will be saved in the Network Configurator v2 network configuration file format.

■ **Saving in the Format of the Higher Version**

To save a project file that was created with Network Configurator version 2.2□ or lower (extension .ncf) in the Network Configurator version 3 network configuration file format, select **File – Save As** and change the file type in the Save As Dialog Box to *Network Configurator v3* before saving the file.

■ **Saving in the Format of the Lower Version**

To save a file that was created on Network Configurator 3.3□ or higher in the Network Configurator v2 file format for version 2.2□ or lower, select **File – Save As** and change the file type in the Save As Dialog Box to Network Configurator v2 file before saving the file. The following dialog box will appear. To save the file in the Network Configurator v2 network configuration file, click the **Yes** Button.

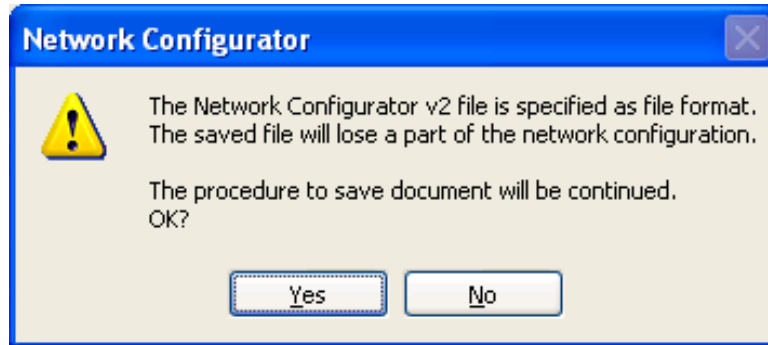

Note If there is a device in the Network Configurator version 1 or version 2 network configuration file (extension .ncf) for which the EDS file is not installed, the Network Configurator will not be able to read the file normally. Install the EDS files for all of the relevant devices in advance.

Displaying Network Bandwidth Usage

With version 2.2□ or lower, only the bandwidth usage for safety I/O communications was displayed. With version 3.3□ or higher, you can display the total bandwidth usage for safety I/O communications and standard I/O communications.

SECTION 1

Overview

1-1	DeviceNet Safety System Overview	2
1-1-1	About DeviceNet Safety	2
1-2	Safety Network Controller Overview	3
1-2-1	About the NE1A-series Safety Network Controllers	3
1-2-2	NE1A Series Features	4
1-2-3	Standard Models	6
1-3	Network Configurator Overview	7
1-3-1	About the Network Configurator	7
1-3-2	Network Configurator Features	7
1-3-3	System Requirements	8
1-3-4	Standard Models	9
1-4	Basic System Startup Procedure	10
1-4-1	System Design and Programming	10
1-4-2	Installation and Wiring	11
1-4-3	Configuration	12
1-4-4	User Test	12

1-1 DeviceNet Safety System Overview

1-1-1 About DeviceNet Safety

DeviceNet is an open-field, multi-vendor, multi-bit network, which combines the controls in the machine and line control levels with information. The DeviceNet Safety network adds safety functions to the conventional standard DeviceNet communications protocol. The DeviceNet Safety concept has been approved by a third-party organization (TÜV Rhineland).

Just as with DeviceNet, DeviceNet Safety-compliant devices from third-party vendors can be connected to a DeviceNet Safety network. Also, DeviceNet-compliant devices and DeviceNet Safety-compliant devices can be combined and connected on the same network.

By combining DeviceNet Safety-compliant products, a user can construct a safety control/network system that meets the requirements for Safety Integrity Level (SIL) 3 according to IEC 61508 (Functional Safety of Electrical/Electronic/Programmable Electronic Safety-related Systems) and the requirements for Safety Category 4 according to EN 954-1.

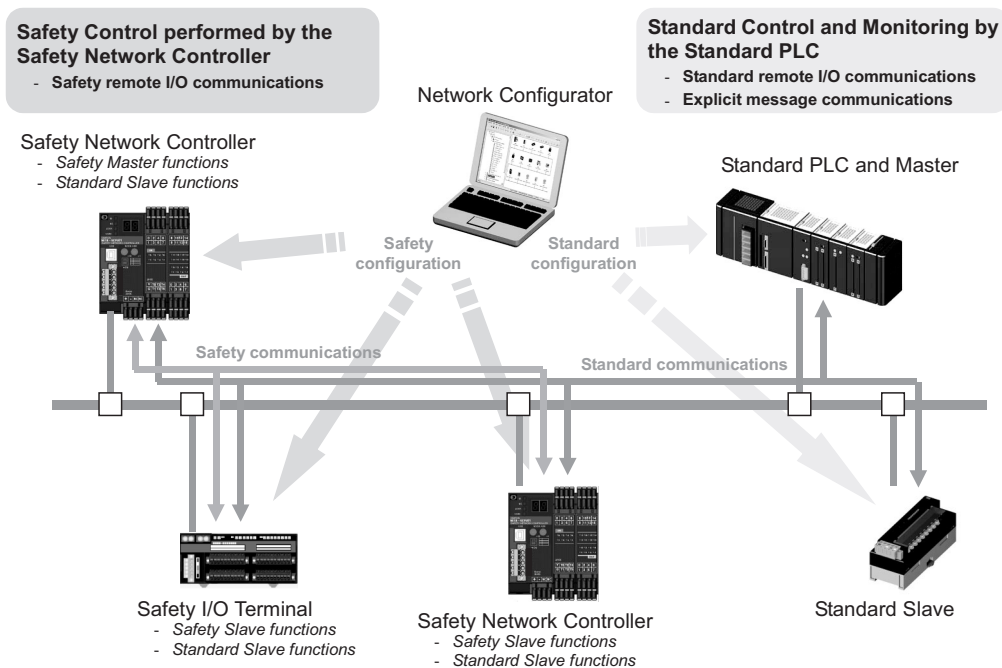

1-2 Safety Network Controller Overview

1-2-1 About the NE1A-series Safety Network Controllers

The NE1A-series Safety Network Controllers provide various functions, such as safety logic operations, safety I/O controls, and a DeviceNet Safety protocol. The NE1A-series Controllers allow the user to construct a safety control/network system that meets the requirements for Safety Integrity Level (SIL) 3 according to IEC 61508 (*Functional Safety of Electrical/Electronic/ Programmable Electronic Safety-related Systems*) and the requirements for Safety Category 4 according to EN 954-1.

In the example system shown below, the safety control system implemented with the NE1A-series Controller and the monitoring system implemented with the standard PLC are realized on the same network.

- As a Safety Logic Controller, the NE1A-series Controller executes safety logic operations and controls local I/O.
- As a Safety Master, the NE1A-series Controller controls the remote I/O of Safety Slaves.
- As a Standard Slave, the NE1A-series Controller communicates with the Standard Master.

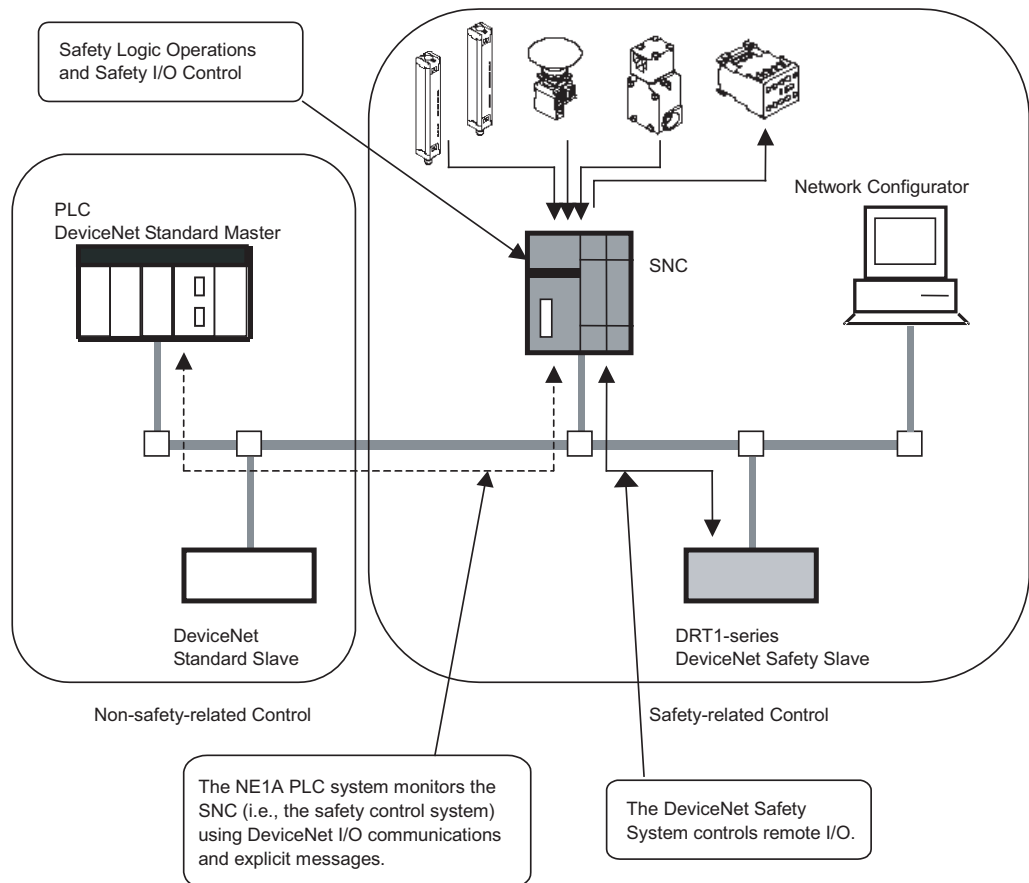

1-2-2 NE1A Series Features

Safety Logic Operations

In addition to basic logic functions, such as AND and OR, the NE1A-series Controllers also support application function blocks, such as Emergency Stop Pushbutton Monitoring and Safety Gate Monitoring, that enable various safety applications.

User-defined Function Blocks

Previously prepared logic functions and function blocks can be combined to create a user-defined function block using the Network Configurator version 1.5□ or higher. This can be used to standardize functions that are used frequently to facilitate reusing them. Passwords can also be used to protect the programming inside the function blocks by making them “black boxes.”

Local Safety I/O

- A total of 24 local safety I/O points are supported by NE1A-SCPU01(-V1) or NE1A-SCPU01-EIP: 16 input terminals and 8 output terminals.
- A total of 48 local safety I/O points are supported by NE1A-SCPU02 or NE1A-SCPU02-EIP: 40 input terminals and 8 output terminals.
- Faults in external wiring can be detected.
- Dual Channel Mode can be set for pairs of related local inputs. When Dual Channel Mode is set, the NE1A-series Controller can evaluate the input data patterns and the time discrepancy between input signals.
- Dual Channel Mode can be set for pairs of related local outputs. When Dual Channel Mode is set, the NE1A-series Controller can evaluate the output data patterns.

DeviceNet Safety Communications

- As a Safety Master, a Pre-Ver. 1.0 NE1A-series Controller can perform safety I/O communications with up to 16 connections using up to 16 bytes per connection.
- As a Safety Master, any NE1A-series Controller other than a Pre-Ver. 1.0 NE1A-series Controller can perform safety I/O communications with up to 32 connections using up to 16 bytes per connection.
- As a Safety Slave, the NE1A-series Controller can perform safety I/O communications with a maximum of four connections using up to 16 bytes per connection.

DeviceNet Standard Communications

As a Standard Slave, the NE1A-series Controller can perform standard I/O communications with one Standard Master for up to two connections using up to 16 bytes per connection.

EtherNet/IP Standard Communications (Controllers that Support EtherNet/IP Only)

As an EtherNet/IP Target, the NE1A-series Controller can perform standard I/O communications with one EtherNet/IP originator for up to two connections using up to 16 output bytes and 128 input bytes per connection.

Disabling DeviceNet Communications (Standalone)

An NE1A-series Controller can be used as a Standalone Controller by using a setting to disable the Controller's DeviceNet communications.

UDP/IP Message Communications (Version 1.1 or Later Controllers with EtherNet/IP)

Message communications with UDP/IP frames can be performed from general-purpose controllers on Ethernet (PLCs, computers, etc.) through NE1A-series Controllers to access NE1A-series Controllers or devices on DeviceNet Safety or DeviceNet networks. (Version 1.1 or later Controllers with EtherNet/IP are required.)

Reading I/O Areas in NE1A EtherNet/IP Targets (Version 1.1 or Later Controllers with EtherNet/IP)

With a version 1.1 or later NE1A-series Controller with EtherNet/IP, standard I/O communications targets can be set for EtherNet/IP to read EtherNet/IP standard I/O areas from explicit message clients without using a dedicated EtherNet/IP standard master.

Writing I/O Areas in NE1A EtherNet/IP Targets (Version 1.1 or Later Controllers with EtherNet/IP)

With a version 1.1 or later NE1A-series Controller with EtherNet/IP, standard I/O communications targets can be set for EtherNet/IP to write EtherNet/IP standard I/O areas from explicit message clients without using a dedicated EtherNet/IP standard master.

Configuration with a Graphical Tool

- Both network configuration and logic programming. It enables easy configuration and programming are performed with WS02-CFSC1-E or WS02-CFSC1-EV□ Network Configurator.
- A Logic Editor can be activated from the Network Configurator.
- Configuration data can be downloaded and uploaded, and devices can be monitored online via DeviceNet, USB, or EtherNet/IP.

System Startup and Error Recovery Support

- Error information can be checked by using the error history or the indicators on the front of the NE1A-series Controller.
- The NE1A-series Controller's internal status information can be monitored from a standard PLC by allocating the information in the Standard Master. In the same way, the information can be monitored from a safety PLC by allocating the information in the Safety Master.
- The NE1A-series Controller's internal status information can be monitored from a standard PLC by allocating the information in an EtherNet/IP Originator.

Access Control with a Password

- NE1A-series Controller configuration data is protected by a password.
- Network configuration files (project files) created with the Network Configurator are also password protected.
- Programs and user-defined function blocks can be password-protected using the Network Configurator version 1.5□ or higher.

1-2-3 Standard Models

Normal Controllers

Model number	Name	Number of I/O points		
		Safety inputs	Test outputs	Safety outputs
NE1A-SCPU01	Safety Network Controller	16 inputs	4 outputs	8 outputs
NE1A-SCPU01-V1, unit version 1.0	Safety Network Controller	16 inputs	4 outputs	8 outputs
NE1A-SCPU02, unit version 1.0	Safety Network Controller	40 inputs	8 outputs	8 outputs
NE1A-SCPU01-V1, unit Ver.2.0	Safety Network Controller	16 inputs	4 outputs	8 outputs
NE1A-SCPU02, unit Ver.2.0	Safety Network Controller	40 inputs	8 outputs	8 outputs

Controllers That Support EtherNet/IP

Model number	Name	Number of I/O points		
		Safety inputs	Test outputs	Safety outputs
NE1A-SCPU01-EIP	Safety Network Controller	16 inputs	4 outputs	8 outputs
NE1A-SCPU02-EIP	Safety Network Controller	40 inputs	8 outputs	8 outputs

1-3 Network Configurator Overview

1-3-1 About the Network Configurator

The WS02-CFSC1-E, WS02-CFSC1-EV□ Network Configurator Support Software is used to configure, set, and manage a DeviceNet Safety network with graphical window operations.

The Network Configurator can be used to configure a virtual DeviceNet Safety network (in the Network Configuration Window) and monitor the configuration and parameters of each safety device and standard device.

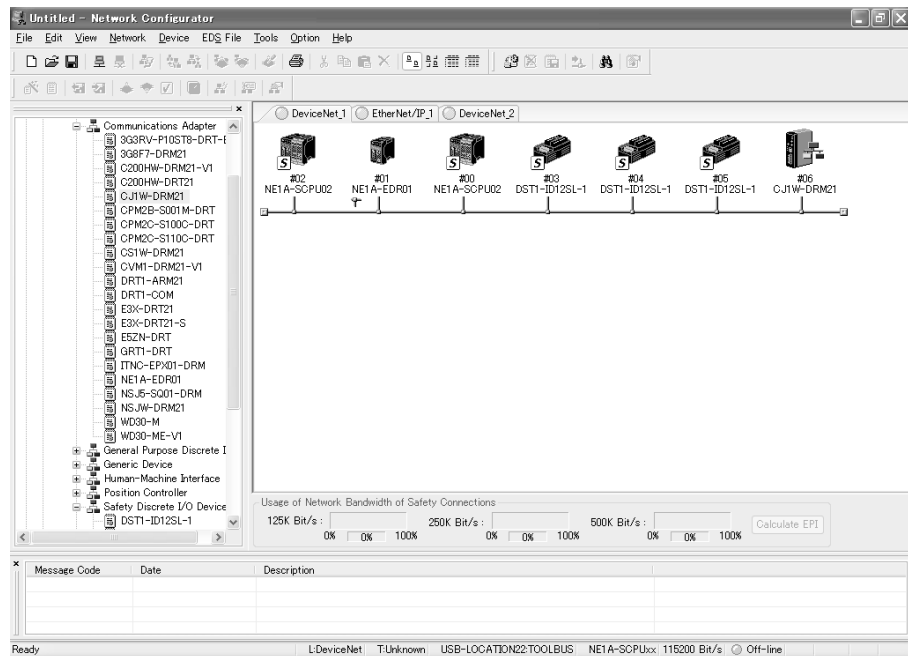

1-3-2 Network Configurator Features

Compliant with Standard and Safety DeviceNet Networks

The Network Configurator can configure and monitor devices that support DeviceNet Safety or EtherNet/IP as well as existing standard DeviceNet devices. It can thus support building systems for standard control, safety control, or mixed standard/safety control.

Multiple Network Configurations Supported (Version 2.0□ or Later)

Multiple DeviceNet network configurations can be made in one project. Starting with version 2.2□, it is also possible to build multiple EtherNet/IP networks in one project.

Safety Network Controller Programming

The Network Configurator provides built-in programming tools for the safety logic of the NE1A-series Controllers and thus enables building DeviceNet Safety applications using only the Network Configurator.

- Previously prepared function blocks can be incorporated in logic. AND/OR and other logic functions and emergency stop button/safety door/light curtain monitoring, and other previously prepared function blocks can be selected from the function block list and placed in the Workspace to create software connections in the logic of the Network Controller.

- User-defined function blocks can be easily created and reused using the Network Configurator version 1.5□ or higher.
New user-defined function blocks can be created. These can be used simply by selecting them from the function block list and placing them in the Workspace. Created user-defined function blocks can be saved to file and installed on another computer to use with the Network Configurator on that computer.
- Editing of user-defined function blocks can be password-protected.

Upward Compatibility with DeviceNet Configurator

All the functions of DeviceNet Configurator are supported. Also, all of the files created by the DeviceNet Configurator can be used as they are.

1-3-3 System Requirements

The following computer system is required in order to use the Network Configurator.

Item	Requirement
Operating system (OS) Japanese or English	<ul style="list-style-type: none"> • Version 2.2□ or Lower Windows 2000 Professional (Service Pack 4 or higher) Windows XP (Service Pack 2 or higher except for 64-bit version) Windows Vista (Service Pack 1 or higher except for 64-bit version) • Version 3.3□ Windows XP (Service Pack 3 or higher except for 64-bit version) Windows Vista (Service Pack 2 or higher) Windows 7 • Version 3.40 or higher Windows XP (Service Pack 3 or higher except for 64-bit version) Windows Vista (Service Pack 2 or higher) Windows 7 Windows 8 Windows 8.1 Windows 10 <p>Note Administer rights are required to install the software.</p>
Computer	A computer with a processor recommended by Microsoft Corporation.
Memory	The memory capacity recommended by Microsoft Corporation.
Hard disk	At least 200 MB of available space is required.
Display	SVGA (800 × 600 pixels) or better high-resolution display with at least 256 colors
Disk drives	CD-ROM drive
Mouse	A mouse or other pointing devices that is compatible with Windows is required.
Communications port (See note.)	At least one of the following communications ports is required. <ul style="list-style-type: none"> • USB port: To go online via a NE1A-SCPU-series or NE0A-series USB port (USB 1.1). • Ethernet port: To go online via Ethernet. • DeviceNet Interface Card (3G8F7-DRM21 or 3G8E2-DRM21-V1): To go online via DeviceNet.

- Note**
- (1) The computer cannot be placed on standby while it is connected to an NE1A-series Controller with a USB cable.
 - (2) The DeviceNet Interface Card is not compatible with a 64-bit OS.

- (3) At least one USB port is required as the communications port of the Maintenance Tool.

1-3-4 Standard Models

Model number	Name	Component	Compatible computer	OS
WS02-CFSC1-E (Version 2.2□)	Network Configurator	Installation disk (CD-ROM)	IBM PC/AT or compatible	Windows 2000 Windows XP (32-bit version only) Windows Vista (32-bit version only)
WS02-CFSC1-EV3 (Version 3.3□)				Windows XP (32-bit version only) Windows Vista (32-bit/64-bit) Windows 7 (32-bit/64-bit)
WS02-CFSC1-EV3 (Version 3.4□)				Windows XP (32-bit only) Windows Vista (32-bit/64-bit) Windows 7 (32-bit/64-bit) Windows 8 (32-bit/64-bit) Windows 8.1 (32-bit/64-bit) Windows 10 (32-bit/64-bit)

1-4 Basic System Startup Procedure

This manual introduces the basic steps that are needed to make the safety system operational, with particular focus on the following steps.

- System Design and Programming
- Configuration
- User Test

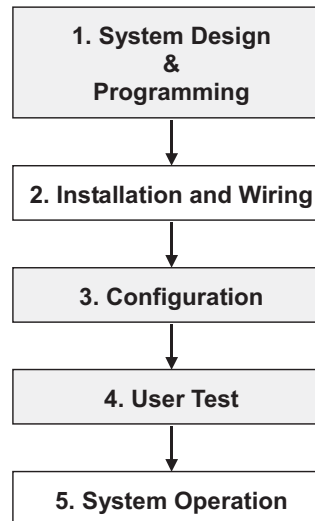

1-4-1 System Design and Programming

In this step, the optimum safety system is determined by the following procedures:

1. Based on the required safety system specifications, select and arrange the safety devices and determine the safety functions to be allocated to each device.
2. Configure the network system as a virtual network in the Network Configurator.
 - Register all of the devices. If the system is a mixed safety control and standard control system, register both the safety devices and standard devices.
 - Set the parameters of all the devices.
 - Check the percentage of the network bandwidth being used and review the parameters.
 - Create the program for the NE1A-series Controller.
 - Verify the system reaction time of all the safety chains.

The network bandwidth usage and the system reaction time are affected by several factors, including the network configuration, NE1A-series Controller and Safety I/O Terminal parameter settings, and NE1A-series Controller program, so repeat the steps above to determine a system configuration which meets the users' requirements.

Please refer to the following sections for the operating instructions of the Network Configurator.

- Device Registration
Refer to 3-5 *Creating a Virtual Network*.

- Editing Device Parameters
Refer to 3-8 Device Parameters and Properties.
Refer to SECTION 5 Editing Safety Network Controller Parameters.
- Checking the Usage Rate of Network Bandwidth
Refer to 2-2 Allocating Network Bandwidth Usage and Calculating the Best EPI.
- Calculating the Reaction Time
Refer to 2-3 Calculating and Verifying the Reaction Time.

IMPORTANT Allocate a unique safety network number to each safety network or safety subnetwork.



1-4-2 Installation and Wiring



In this step, install and wire each device as shown below:

- Install all of the devices and set node addresses and baud rates.
- Connect to I/O devices.
- Wire the power supplies.
- Wire the DeviceNet.
- Wire the USB.
- Wire the EtherNet/IP.

Please refer to the following related manuals for details:

Item	Manual name	Cat. No.
DeviceNet installation	DeviceNet Operation Manual	W267
EtherNet/IP installation	DeviceNet Safety System Configuration Manual	Z905
NE1A-series Controller installation	DeviceNet Safety Safety Network Controller Operation Manual	Z906
DeviceNet Safety I/O Terminal installation	DeviceNet Safety I/O Terminal Operation Manual	Z904
Installation of other devices	Operation manual for each device	---

 WARNING	
Safety functions may be impaired and serious injury may occasionally occur. Before connecting a device to the network, clear the previous configuration data.	

 WARNING	
Safety functions may be impaired and serious injury may occasionally occur. Before connecting a device to the network, set the appropriate node address and baud rate.	

1-4-3 Configuration

In this step, transfer the parameters for each device created by the Network Configurator to the actual device to make the system operative.

Use the Network Configurator to perform the following operations:

1. Download
The parameters set in the Network Configurator's virtual network are transferred to the actual device and stored in each device.
2. Verification
Verify the safety device settings.
The user confirms that the parameters and safety signatures stored in each device are correct.

Please refer to the following sections for the operating instructions of the Network Configurator.

- Download
Refer to *3-8 Device Parameters and Properties*.
- Verification
Refer to *3-9 Parameter Verification*.

IMPORTANT

- After downloading the device parameters, verify the parameters to confirm that the parameters and the safety signature saved in the devices are correct.
- When selecting Open Only in the Open Type setting for the safety connection, check that the Safety Master and Safety Slave are correctly configured.

1-4-4 User Test

In this step, the user himself confirms the program operation and performs functional tests.

Always perform the user test, because it is the user's responsibility to verify the system operation. The user test verifies the correctness of all parameters downloaded to each safety device, as well as each device's safety signature. To demonstrate that all parameters and safety signatures are correct after completing the user test, perform a Configuration Lock operation on all of the safety devices.

Refer to *3-10 Configuration Lock* for details on performing a Configuration Lock from the Network Configurator.

WARNING

Safety functions may be impaired and serious injury may occasionally occur. Before operating the system, perform user testing to confirm that the configuration data of all the devices is correct and that they are operating correctly.



IMPORTANT

- After configuring all the devices, user testing must be performed to check if the configuration data and device operation of each device are correct. User testing is performed to verify the safety signature for each device.
- The configuration must be locked after the user testing has completed.

SECTION 2

Constructing a Safety Network

2-1	Applications	14
2-1-1	Establishing a New Safety Network	14
2-1-2	Changing an Established Safety Network	17
2-2	Allocating Network Bandwidth Usage and Calculating the Best EPI	21
2-2-1	Checking the Network Bandwidth	21
2-2-2	Displaying Device Bandwidth Usage Conditions	22
2-2-3	Allocating Network Bandwidth Usage Rates and Calculating Best EPI	23
2-2-4	Example of EPI Calculations	27
2-3	Calculating and Verifying the Reaction Time	31
2-3-1	Concept of Reaction Time	31
2-3-2	Calculating the Maximum Reaction Time	32
2-3-3	Verifying the Maximum Reaction Time	36

2-1 Applications

This section describes how to construct a DeviceNet Safety Network in the following two cases.

1. Establishing a new Safety Network
2. Changing an established Safety Network

2-1-1 Establishing a New Safety Network

This section describes the procedure for establishing a system by designing a new Safety Network using the Network Configurator and then downloading the parameters to the network devices.

System Design and Programming

1. Starting the Network Configurator

Start the Network Configurator.

Refer to *3-2-1 Starting and Exiting the Network Configurator*.

2. Creating the Virtual Network

Create the virtual network by adding a device from the Hardware List. If the user is to specify the network number, set the network number as well.

Refer to *3-5 Creating a Virtual Network*.

3. Editing and Programming Device Parameters

Set the parameters of the NE1A-series Controller configured in the virtual network.

Refer to *SECTION 5 Editing Safety Network Controller Parameters* and to the *Safety Network Controller Operation Manual (Z906)*.

Program the NE1A-series Controllers configured in the virtual network.

Refer to *SECTION 6 Programming the Safety Network Controller* and to the *Safety Network Controller Operation Manual (Z906)*.

4. Verifying the Network Bandwidth to Use

Confirm that the bandwidth used in the safety I/O communications does not exceed the acceptable bandwidth in the network. If exceeded, re-examine the procedure from network configuration in step 2.

Refer to *2-2 Allocating Network Bandwidth Usage and Calculating the Best EPI*.

5. Calculating and Verifying the Maximum Reaction Time

Calculate the maximum reaction time of all the safety chains and check if the requirement specifications are met. If the requirement specifications are not met, re-examine the procedure from network configuration in step 2.

Refer to *2-3 Calculating and Verifying the Reaction Time*.

6. Saving the Network Configuration File

Save the network configuration file with the completed design.

Refer to *3-6-2 Saving the Network Configuration File*.

7. Exiting the Network Configurator

Exit the Network Configurator.

The following operations are performed by connecting the Network Configurator to the network after the network installation and wiring.

IMPORTANT Allocate a unique safety network number to each safety network or safety subnetwork.

Configuration

8. Starting the Network Configurator and Connecting to the Network

Start the Network Configurator and connect it to the network via the USB port on the NE1A-series Controller or via DeviceNet or EtherNet/IP.

Refer to *3-4 Connecting to the Network*.

9. Reading the Network Configuration File

Read the saved network configuration file with the completed design.

Refer to *3-6-3 Reading a Network Configuration File*.

10. Resetting a Device

When changing the configuration because of user testing results or when downloading the parameters again, it is necessary to clear the previous configuration before downloading the new parameters. Reset the device by setting the reset type to *Return to the out-of-box configuration*, and then emulate cycling power.

Refer to *3-11-2 Resetting Devices*.

11. Downloading Device Parameters

Download the parameters to all the devices.

Refer to *3-8-3 Downloading Device Parameters*.

12. Confirming the Downloaded Device Parameters and Safety Signatures

Verify the parameters for all the devices and check if the device parameters and program that the user input have been correctly downloaded and saved in the devices.

Refer to *3-9 Parameter Verification*.

13. Saving the Network Configuration File

Save the network configuration file in which parameter verification of all the devices has been completed.

Refer to *3-6-2 Saving the Network Configuration File*.

14. Exiting the Network Configurator

Exit the Network Configurator.

IMPORTANT

- After downloading the device parameters, verify the parameters to confirm that the parameters and the safety signature saved in the devices are correct.
- When selecting *Open Only* in the Open Type setting for the safety connection, check that the Safety Master and Safety Slave are correctly configured.

User Testing

15. User Testing

The user himself must verify device parameters and operation to confirm that safety system requirement specifications are met.

16. Starting the Network Configurator and Connecting to the Network

Start the Network Configurator and connect it to the network via the USB port on the NE1A-series Controller or via DeviceNet or EtherNet/IP. Refer to *3-4 Connecting to the Network*.

17. Reading the Network Configuration File

Read the saved network configuration file with parameters that are already verified.

Refer to *3-6-3 Reading a Network Configuration File*.

18. Configuration Lock

Lock the configuration of all the devices to indicate that they have been verified as well as to prevent parameters from being mistakenly rewritten.

Refer to *3-10-1 Locking the Device Configuration*.

19. Saving the Network Configuration File

Save the network configuration file of the virtual network in which the configuration is locked.

Refer to *3-6-2 Saving the Network Configuration File*.

20. Exiting the Network Configurator

Exit the Network Configurator.

WARNING

Safety functions may be impaired and serious injury may occasionally occur. Before operating the system, perform user testing to confirm that the configuration data of all the devices is correct and that they are operating correctly.



IMPORTANT

- After configuring all the devices, user testing must be performed to check if the configuration data and device operation of each device are correct. User testing is performed to verify the safety signature for each device.
- The configuration must be locked after the user testing has completed.

Running the System

21. Running the System

Run the system.

2-1-2 Changing an Established Safety Network

This section describes procedure to change the Safety Network after the system is running.

Changing the System

1. Stopping the System

Turn OFF the power supplies to moving parts, such as motors, and stop the system. Continue supplying power to the network and the NE1A-series Controller.

2. Starting the Network Configurator and Connecting to the Network

Start the Network Configurator and connect it to the network via the USB port on the NE1A-series Controller or via DeviceNet or EtherNet/IP.

Refer to 3-2-1 *Starting and Exiting the Network Configurator* and 3-4 *Connecting to the Network*.

3. Uploading the Network Configuration

Upload the network to obtain the current network configuration.

Refer to 3-5 *Creating a Virtual Network*.

4. Unlocking the Configurations

Unlock the configurations of all the devices to enable changing the network configuration.

Refer to 3-10-2 *Unlocking the Device Configuration*.

5. Resetting a Device

Before changing device parameters and node address, clear the configuration of the device. Reset the device by setting the reset type to *Return to the out-of-box configuration*, and then emulate cycling power.

Refer to 3-11-2 *Resetting Devices*.

6. Exiting the Network Configurator

Exit the Network Configurator.

7. Changing the System

Change the network, wiring, and node addresses and add or delete devices according to the specified system changes. Safety devices that are being newly added must be configured in advance.

Refer to 3-11-2 *Resetting Devices*.

WARNING

Safety functions may be impaired and serious injury may occasionally occur. Before connecting a device to the network, clear the previous configuration data.



WARNING

Safety functions may be impaired and serious injury may occasionally occur. Before connecting a device to the network, set the appropriate node address and baud rate.



Note There is no need to use the saved network configuration file, because the purpose of this procedure is to unlock the device configurations and reset devices to the default configurations.

Redesigning the System

8. Starting the Network Configurator

Start the Network Configurator to redesign the network.

9. Reading the Network Configuration File

Read the saved network configuration file with a locked configuration.

Refer to *3-6-3 Reading a Network Configuration File*.

10. Changing the Virtual Network

Add or delete the devices and change the node addresses according to specified changes.

Refer to *3-5 Creating a Virtual Network*.

11. Changing the Device Parameters and Program

Set and change the parameters of the NE1A-series Controllers configured in the virtual network according to specified changes.

Refer to *SECTION 5 Editing Safety Network Controller Parameters* and to the *Safety Network Controller Operation Manual (Z906)*.

Create and change the programs of the NE1A-series Controllers configured in the virtual network according to specified changes.

Refer to *SECTION 6 Programming the Safety Network Controller* and to the *Safety Network Controller Operation Manual (Z906)*.

12. Verifying the Network Bandwidth to Use

Confirm that the bandwidth used in the safety I/O communications does not exceed the acceptable bandwidth in the network. If exceeded, re-examine the specified changes.

Refer to *2-2 Allocating Network Bandwidth Usage and Calculating the Best EPI*.

13. Recalculating and Verifying the Maximum Reaction Time

Calculate the maximum reaction time of all the safety chains and check if the requirement specifications are met. If the requirement specifications are not met, re-examine the specified changes.

Refer to *2-3 Calculating and Verifying the Reaction Time*.

14. Saving the Network Configuration File

Save the network configuration file with the completed changes.

Refer to *3-6-2 Saving the Network Configuration File*.

15. Exiting the Network Configurator

Exit the Network Configurator.

The following operations are performed by connecting the Network Configurator to the network after the actual system changes have been completed.

IMPORTANT

- Allocate a unique network number when establishing a network or sub-network.
- If the parameters of a Safety Slave or Standard Slave are changed, the parameter information will not match in the Safety Master or Standard Master in which the Slave is registered. Therefore, a yellow [!] symbol will be displayed next to the slave icon. If this symbol is displayed, check the slave information by opening the Edit Parameter Window of the Master. Allocate a unique network number when establishing a network or subnetwork with Safety Slaves.

- Note** If device parameters with a locked configuration are changed, the color of the key icon will change to yellow.

Re-configuration

16. Starting the Network Configurator and Connecting to the Network

Start the Network Configurator and connect it to the network via the USB port on the NE1A-series Controller or via DeviceNet or EtherNet/IP.

Refer to *3-4 Connecting to the Network*.

17. Reading the Network Configuration File

Read the saved network configuration file with the completed design changes.

Refer to *3-6-3 Reading a Network Configuration File*.

18. Downloading Device Parameters

Download the parameters to all the devices.

Refer to *3-8-3 Downloading Device Parameters*.

19. Confirming the Downloaded Device Parameters and Safety Signature

Verify the parameters for all devices with an icon indicating pre-verification and check if the device parameters and program that the user input are correctly downloaded and saved to the devices.

Refer to *3-9 Parameter Verification*.

20. Saving the Network Configuration File

Save the configuration file for a network in which parameter verifications of all the devices have been completed.

Refer to *3-6-2 Saving the Network Configuration File*.

21. Exiting the Network Configurator

Exit the Network Configurator.

IMPORTANT

- After downloading the device parameters, verify the parameters to confirm that the parameters and the safety signature saved in the device are correct.
- When selecting *Open Only* in the Open Type setting for the safety connection, check that the Safety Master and Safety Slave are correctly configured.

Note

- In the Network Configuration Pane, the device will be displayed as locked, but the actual device has already been unlocked. Therefore, the parameters can be downloaded.
- If downloading to a device with a key icon color that has changed to yellow because of parameter changes, the icon must be returned to the state before verification (white [S] symbol).
- If downloading to a device with a key icon color that has not changed because parameters have not been changed, the icon must be returned to the state indicating that verification has been completed (green [S] symbol).

Additional User Testing

22. User Testing

The user himself must verify device parameters and operation to confirm that the safety system requirement specifications are met.

23. Starting the Network Configurator and Connecting to the Network

Start the Network Configurator and connect it to the network via the USB port on the NE1A-series Controller or via DeviceNet or EtherNet/IP.

Refer to 3-4 *Connecting to the Network*.

24. Reading the Network Configuration File

Read the saved network configuration file with verified parameters.

Refer to 3-6-3 *Reading a Network Configuration File*.

25. Configuration Lock

Lock the configuration of all the devices to indicate that they have been verified as well as to prevent parameters from being mistakenly rewritten.

Refer to 3-10-1 *Locking the Device Configuration*.

26. Saving the Network Configuration File

Save the file of a virtual network with a locked configuration.

Refer to 3-6-2 *Saving the Network Configuration File*.

27. Exiting the Network Configurator

Exit the Network Configurator.

! WARNING

Safety functions may be impaired and serious injury may occasionally occur. Before operating the system, perform user testing to confirm that the configuration data of all the devices is correct and that they are operating correctly.

**IMPORTANT**

- After configuring all the devices, user testing must be performed to confirm that the configuration data and operation of each device are correct. User testing is performed to verify the safety signature for each device.
- The configuration must be locked after user testing has been completed.

Restarting the System**28. Running the System**

Run the system.

2-2 Allocating Network Bandwidth Usage and Calculating the Best EPI

Almost all of the DeviceNet network bandwidth can be used for safety I/O and standard I/O communications.

Communications may time out, however, if the connection settings exceed the acceptable bandwidth usage for each type of communications.

Check the connection settings and, if a setting is found to exceed the acceptable bandwidth usage rate, the setting must be changed to the value outlined in the following table.

• Safety I/O communications	EPI (Expected Packet Interval) setting for safety connections
• Standard I/O communications	Master communications cycle time

The network configuration may need to be changed if the settings exceed the acceptable bandwidth usage rate as a result of securing the required communications performance (i.e., the required network reaction time for safety I/O communications).

This section describes how to check the network bandwidth in the designed network, how to calculate the best EPI from the set bandwidth usage rate, and how to re-set the value.

2-2-1 Checking the Network Bandwidth

The actual network bandwidth usage rate for the connections set in the virtual network is displayed at the bottom of the Network Configuration Window. The network bandwidth usage rate is displayed for each baud rate, as shown in the following diagram.

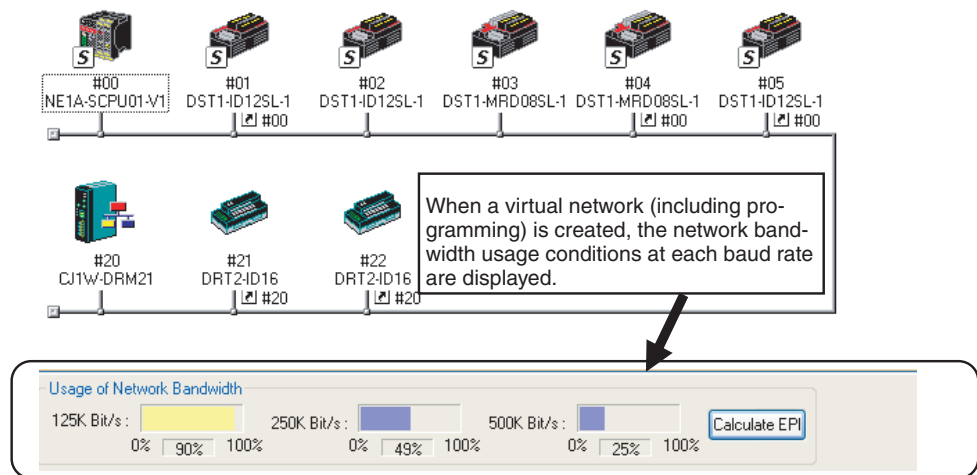

As shown in the diagram, the faster the baud rate, the lower the bandwidth usage rate.

IMPORTANT

- Keep 10% or more of the network bandwidth available for establishing connections and for explicit message communications with the Network Configurator, whether using only safety I/O communications or using both safety I/O and standard I/O communications. Even if 10% or more is available, however, safety or standard communica-

tions might time out, depending on the Network Configurator operation (e.g., monitoring or other operations that create a load on the network) or if the user application uses explicit message communications. If timeouts occur, reduce the network bandwidth usage rate (i.e., increase the unused bandwidth).

- If you are using Network Configurator version 2.2 or lower, the displayed network bandwidth usage does not include standard I/O communications. If you are using both safety and standard I/O communications, refer to 2-2-3 Allocating Network Bandwidth Usage Rates and Calculating Best EPI and set the EPI for each safety connection and the communications cycle times for the Standard Masters.

2-2-2 Displaying Device Bandwidth Usage Conditions

The conditions of bandwidth used in the EtherNet/IP network can be displayed. The function applies to all EtherNet/IP devices and can be used if the EtherNet/IP network is displayed.

1. Click the tab for the EtherNet/IP Network Configuration Window.

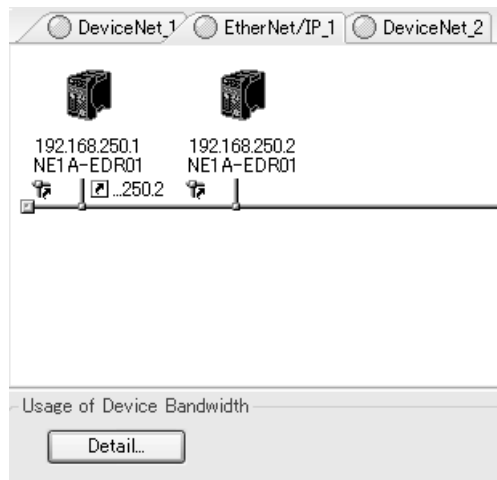

2. Click the **Detail** Button. The Usage of Device Bandwidth Dialog Box will be displayed.

 A screenshot of the 'Usage of Device Bandwidth' dialog box. It contains a table with the following data:

#	Comment	Usage of Cap...	Mbit/s	Usage of IP m...
192.168.250.1	NE1A-EDR01	5.06%	0.189Mbit/s	3
192.168.250.2	NE1A-EDR01	5.06%	0.189Mbit/s	0

 At the bottom of the dialog box, there is a 'Set Packet Interval (RPD) ...' button, a label 'Total usage of IP multicast addresses : 3', and a 'Close' button.

Display Details and Operation

Item	Description
#	IP address
Comment	Device name
Usage of Capacity	Displays the present percentage of the send/receive packet processing capacity that the device supports.
Mbit/s	Number of bits presently processed per seconds by the Ethernet port for a device.
Usage of IP multicast addresses	Number of multicast addresses used.
Set Packet Interval (RPI) Button	This button is not used for DeviceNet Safety-EtherNet/IP systems.
Close Button	Closes the Usage of Device Bandwidth Dialog Box.

2-2-3 Allocating Network Bandwidth Usage Rates and Calculating Best EPI

The average EPIs for safety I/O communications and standard I/O communications and the best communications cycle time are calculated by entering the network bandwidth usage rate for each type of communications into the Network Configurator.

Calculate the best average EPIs and the best communications cycle using the following procedure. The network configuration might need to be changed if the required communications characteristics cannot be achieved.

1. Make the required settings for the virtual network on the Network Configurator, including creating programs for the Safety Network Controller.
2. Click the **Calculate EPI** Button at the bottom of the Network Configuration Window. The Calculate EPI Dialog Box will be displayed.
3. Input the network bandwidth used in safety I/O communications and the bandwidth used in standard I/O communications.

- If using only safety I/O communications:

Input the network bandwidth used by the safety connections as 90% or less and input 0% for the network bandwidth used by standard connections.

If using both safety and standard I/O communications:

Input the total network bandwidth used for safety and standard connections as 90% or less, e.g., 40% for safety connections and 30% for standard connections.

Safety and standard I/O communications will use the bandwidth based on the rates specified here.

4. Click the **Calculate** Button.
5. The best average EPI of all the connections in the safety I/O communications and the optimum Master communications cycle time in the standard I/O communications will be displayed for each baud rate.

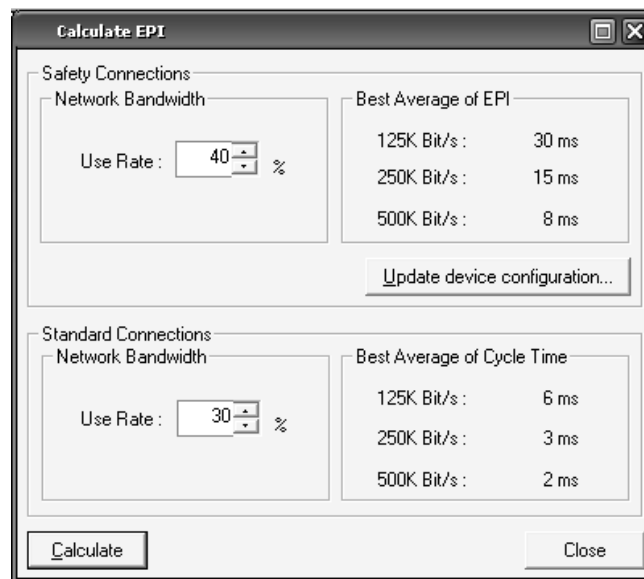

6. Perform the following trial calculation.
 - When using safety I/O communications only
 - Increase the network bandwidth for safety connections to 90%. If the desired best EPI for each safety connection cannot be calculated, try increasing the EPI for connections that need faster speeds (EPI settings, step 9 as described later).
 - When using a mixture of safety and standard I/O communications:
 - Try changing the network bandwidth usage rate and calculating the EPI, as described below.
 - Increase the usage rate for safety connections to shorten the EPI for safety I/O communications and lengthen the communications cycle time for standard I/O communications.
 - Conversely, increase the usage rate for standard communications to shorten the cycle time for standard I/O communications and increase the EPI for safety I/O communications.
7. Check the Safety Network Controller cycle time.

Next, check that the cycle times calculated in the previous steps are longer than the Safety Network Controller cycle time. If they are shorter, the Safety Network Controller cycle time will be the minimum that can be set for the EPI. The Safety Network Controller cycle time can be checked offline after creating the program, under *Cycle Time* on the Mode/Cycle Time Tab in the Edit Device Parameters Dialog Box. Refer to *5-6 Setting the Operating Mode and Confirming the Cycle Time*.

IMPORTANT The minimum possible EPI setting is larger value of either the Safety Network Controller cycle time or the Safety Slave cycle time (fixed at 6 ms). The minimum possible EPI will be affected, therefore, if the Safety Network Controller cycle time is longer than 6 ms.

8. Reconsider the network configuration itself if you have performed the test calculation as outlined above and either of the following occur, i.e.,
 - the desired best average EPI for each safety connection and the best communications cycle time for the Standard Master cannot be calculated, or
 - the Safety Network Controller cycle time is longer than the best average EPI.

Consider adjusting the following aspects of the network configuration.

- Reducing the number of nodes or I/O points.
 - Splitting the network
 - If using both safety and standard I/O communications, split the network into a DeviceNet Safety network and a standard DeviceNet network.
 - If using only safety I/O communications, split the network into two DeviceNet Safety networks.
9. Change the EPI settings for each safety connection and the Standard Master communications cycle time setting to suit the desired baud rate.

• Changing the EPI Settings for Each Safety I/O Connection

The best average EPI calculated is the best average of all safety connections.

The following method is used for setting the calculated EPI as the EPI in the parameters for all safety connections.

- Method for batch setting the best EPI to devices

a. Click the **Update Device Configuration** Button.

The Update Device Configuration Dialog Box will be displayed.

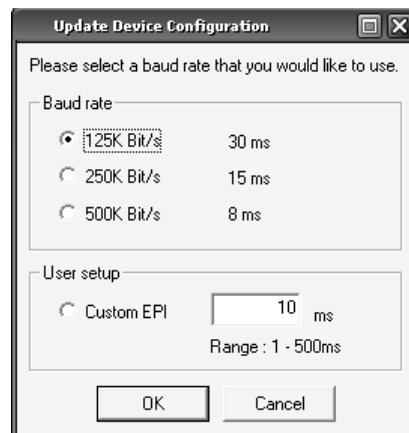

- b. Select the baud rate to be used and click the **OK** Button.
The calculated best average EPI value will be batch set as the EPI in the safety connection parameters for all devices.
- c. If required, adjust the EPI settings for the whole network, making the EPI smaller for those connections that need a faster response time (e.g., for safety curtain connections) and making the EPI larger for those connections that do not need a fast response (e.g., for door switches not used in hazardous areas).

Refer to the reaction time listed in the EPI field to check what the reaction time will be for each safety connection EPI setting.

Note Set the EPI for each safety connection longer than Safety Network Controller cycle time. If the EPI is shorter, errors will occur when the safety connection parameters are downloaded and the download will fail.

• Changing Standard Master Communications Cycle Times

The value calculated as the best average cycle time is the best communications cycle time for the Standard Master.

Set the calculated value as the Standard Master communications cycle time.

If you are using Network Configurator version 3.3□ or higher, you can use the **Update Device Configuration** Button to set the communications cycle time for all Standard Masters at the same time (in the same way as for the EPIs for safety I/O connections).

10. Reconfirm the bandwidth usage rate.

If the EPI settings in the safety connection parameters or the Standard Master communications cycle time setting has been changed based on the calculation results, check that the network bandwidth usage when safety connections are used, displayed at the bottom of the Network Configuration Window, is less than the value input in the Calculate EPI Dialog Box. It is particularly important to check the bandwidth usage rate if the best average EPI has been adjusted for each connection rather than applied as a batch setting.

Note The EPI is set in 1-ms units, so the network bandwidth usage rate may be smaller than the input value if the calculation result is input directly.

11. Perform a test to ensure that there are no problems with the set values.

2-2-4 Example of EPI Calculations

The following network configuration is used for an example of calculating the EPI.

Conditions

The baud rate is 500 Kbit/s.

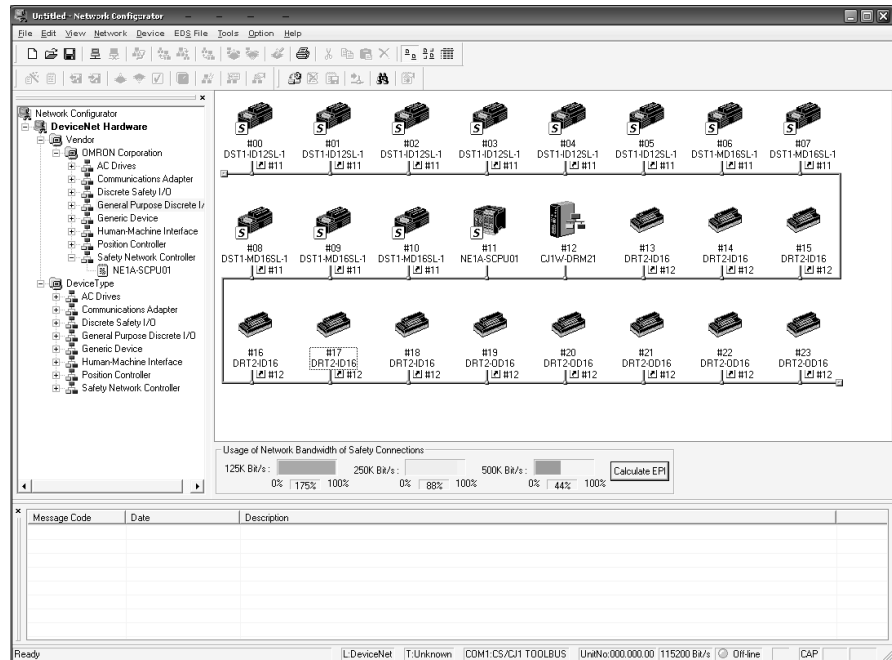

■ Safety I/O Communications

Example: The NE1A-series Controller sets safety connections between six DST1-ID12SL-1 Input Terminals and five DST1-MD16SL-1 I/O Terminals. The default set values are used for all the safety connections, and the EPI is 10 ms.

■ Standard I/O Communications

Example: The CJ1W-DRM21 sets the standard connections between six DRT2-ID16 Input Terminals and five DRT2-OD16 Output Terminals. The default set values are used, and the communications cycle of the CJ1W-DRM21 is automatically set but it attempts to operate at a cycle time of about 3.2 ms.

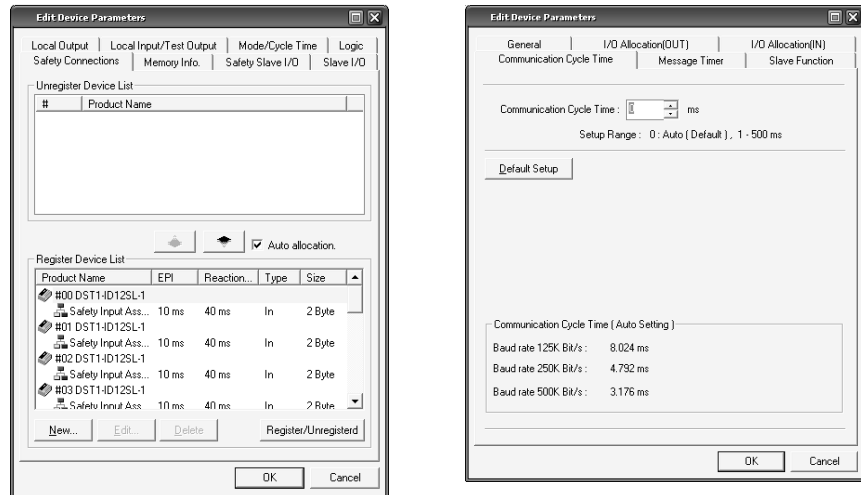

Calculations

Here, we allocate 70% network bandwidth usage rate to safety connections and 20% to standard connections.

Click the **Calculate** Button and from the calculation results, you can see the EPI for the safety connections can be set to 7 ms and the communications cycle of the Standard Master can be set to 6 ms.

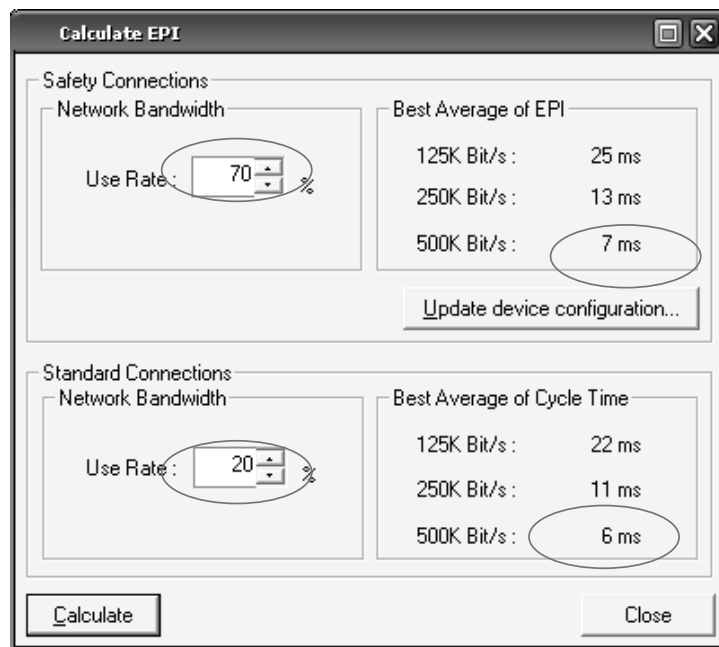

Checking the Safety Network Controller Cycle Time

If, for example, the Safety Network Controller cycle time was 6 ms, it is shorter than the calculation result of 7 ms which means the result can be set as the EPI.

Changing Settings

Changing the EPI Settings for Each Safety I/O Connection

Set the EPI of all safety connections set in the NE1A-series Controller to 7 ms according to the calculation results.

Click the **Update Device Configuration** Button to batch set the calculation result of 7 ms as the EPI for all safety connections by selecting the baud rate to be used.

Refer to 2-2-3 Allocating Network Bandwidth Usage Rates and Calculating Best EPI.

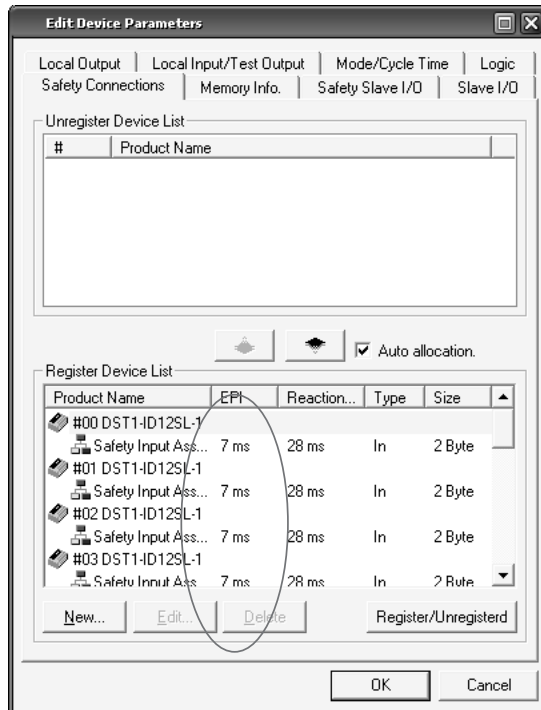

Changing Standard Master Communications Cycle Time Settings

Set the communications cycle of the CJ1W-DRM21 to 6 ms.

If you are using Network Configurator version 3.3□ or higher, you can click the Update Device Configuration Button and select the baud rate to set the communications cycle time for all Standard Masters to the calculated result of 6 ms.

(Refer to 2-2-3 *Allocating Network Bandwidth Usage Rates and Calculating Best EPI.*)

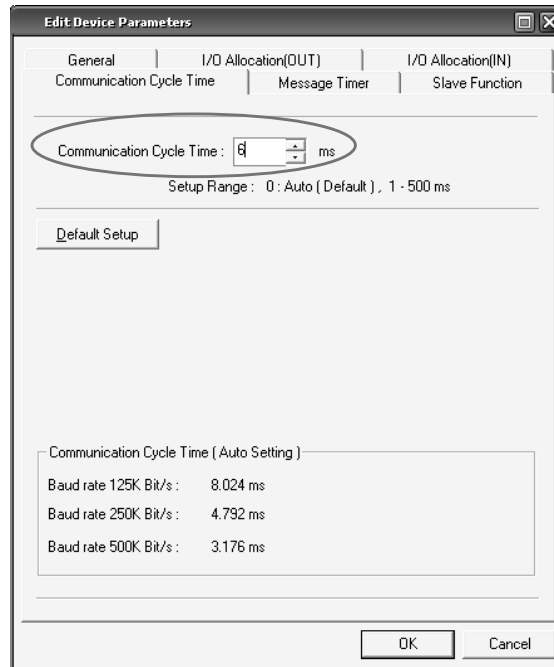

2-3 Calculating and Verifying the Reaction Time

The last step in designing the network is calculating the reaction time of safety chains. The user must check that the reaction time in all the safety chains meets the requirement specifications.

2-3-1 Concept of Reaction Time

Reaction time is the worst down time among the running devices considering faults and failures in safety chains. The safety distance is calculated from reaction time.

The reaction time is calculated for each safety chain. The typical combinations of safety chains are as follows:

1. Standalone NE1A-series Controller (DeviceNet Communications Disabled)

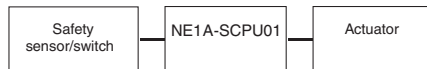

2. Remote Input – NE1A-series Controller Output

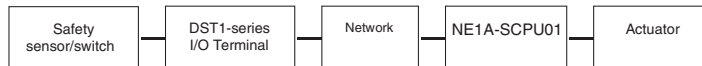

3. NE1A-series Controller Input – Remote Output

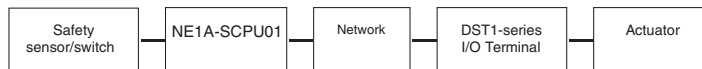

4. Remote Input – Remote Output

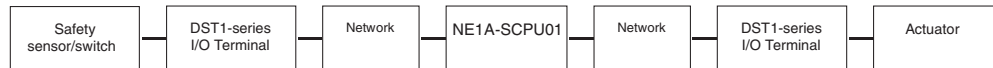

Note Even if a fault or failure occurs in a safety chain, the output shutoff time is ensured as the maximum reaction time.

2-3-2 Calculating the Maximum Reaction Time

Reaction Time Components

Reaction time components are displayed for each safety chain.

1. Standalone NE1A-series Controller (DeviceNet Communications Disabled)

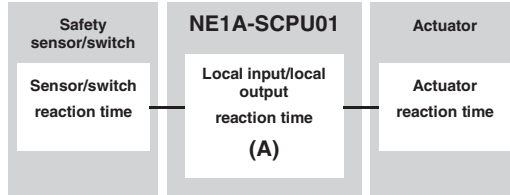

2. Remote Input – NE1A-series Controller Output

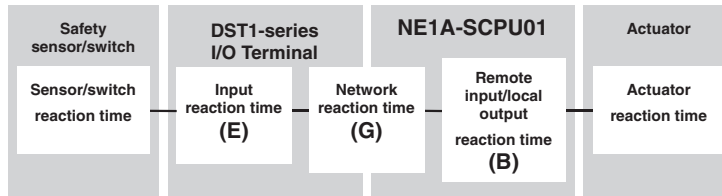

3. NE1A-series Controller Input – Remote Output

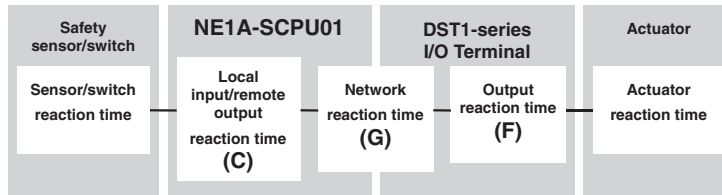

4. Remote Input – Remote Output

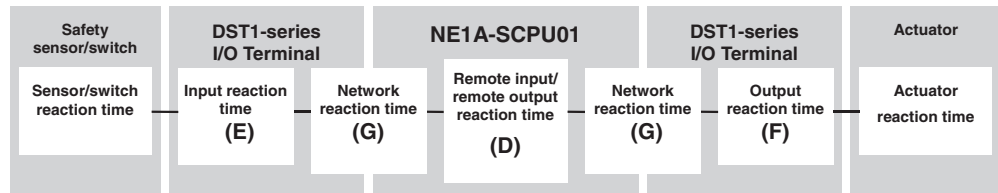

Maximum Reaction Time Formula

	Item	Time formula
A	Local input/local output reaction time of the NE1A-series Controller (ms)	ON/OFF delay + I/O refresh cycle time + NE1A-series Controller cycle time × 2 + 2.5
B	Remote input/local output reaction time of the NE1A-series Controller (ms)	NE1A-series Controller cycle time + 2.5
C	Local input/remote output reaction time of the NE1A-series Controller (ms)	ON/OFF delay time + I/O refresh cycle time + NE1A-series Controller cycle time × 2
D	Remote input/remote output reaction time of the NE1A-series Controller (ms)	NE1A-series Controller cycle time
E	Input reaction time of the DST1-series I/O Terminal (ms)	ON/OFF delay time + 16.2
F	Output reaction time of DST1-series I/O Terminal (ms)	6.2 + Relay reaction time (DST1-MRD08SL-1 only)
G	Network reaction time (ms)	Use the Network Configurator calculation result.

IMPORTANT In the SNC program, add the time for the NE1A-series Controller cycle time to the reaction time of the safety chain when the output from a function block is fed back to the input side of the function block.

Check the NE1A-series Controller cycle time, I/O refresh cycle time, and network reaction time in the Network Configurator.

Check the NE1A-series Controller cycle time and I/O refresh time in **Mode/Cycle Time** Tab of the Edit Device Parameters Window.

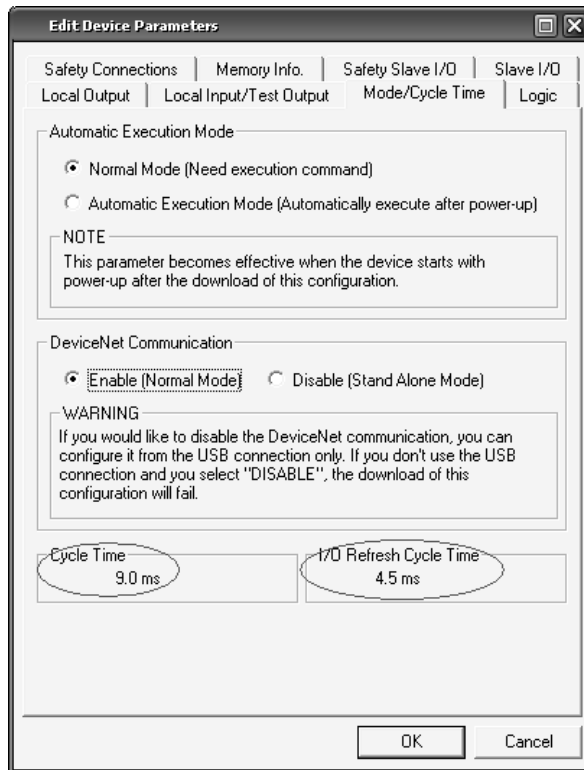

Check the network reaction time in the **Safety Connection** Tab of the Edit Device Parameters Window.

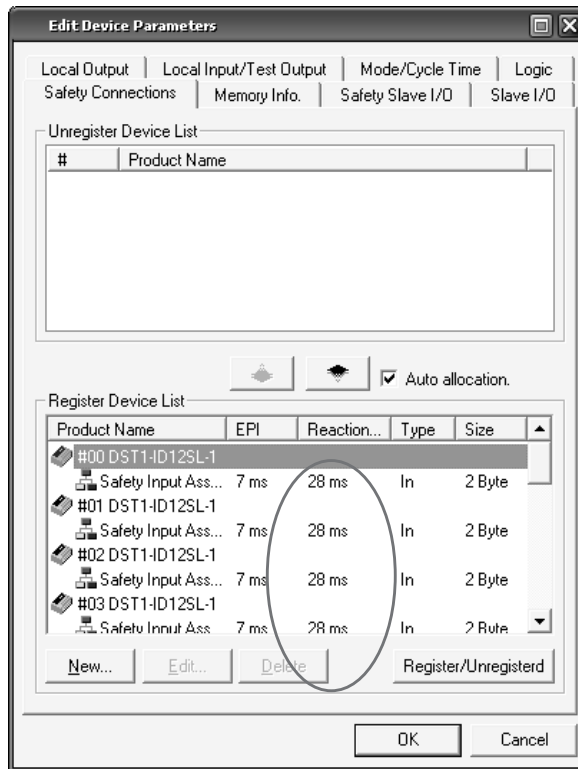

Example of Maximum Reaction Time Calculation

Example 1: Remote Input – NE1A-series Controller Output

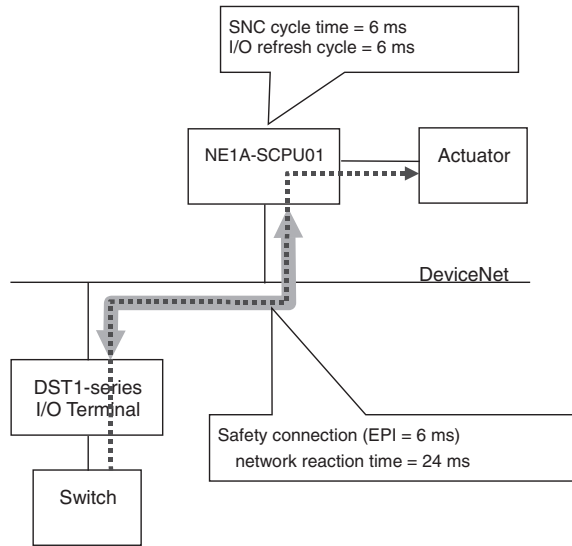

Maximum reaction time (ms)

$$\begin{aligned}
 &= \text{Switch reaction time} \\
 &\quad + \text{DST1-series I/O Terminal input reaction time} \\
 &\quad + \text{Network reaction time} \\
 &\quad + \text{NE1A-series Controller remote input/local output reaction time} \\
 &\quad + \text{Actuator reaction time} \\
 &= \text{Switch reaction time} \\
 &\quad + \text{ON/OFF delay (DST1-series I/O Terminal)} + 16.2 \\
 &\quad + 24 \\
 &\quad + 6 + 2.5 \\
 &\quad + \text{Actuator reaction time} \\
 &= \underline{\underline{48.7 + \text{ON/OFF delay} + \text{Switch reaction time} + \text{Actuator reaction time}}}
 \end{aligned}$$

Example 2: Local Input – Remote Output

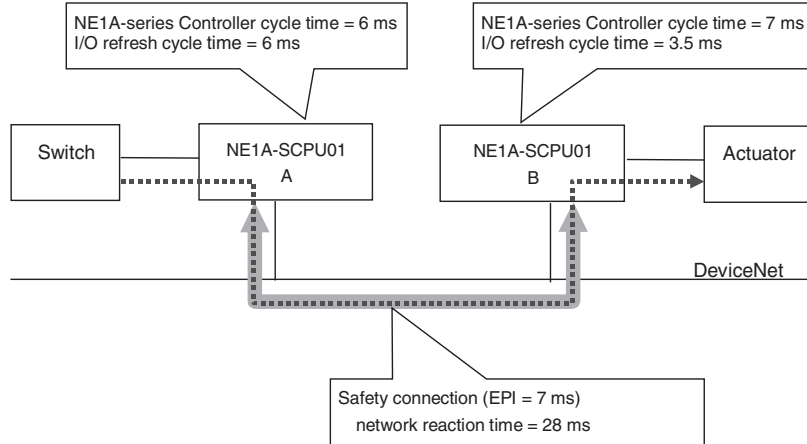

Maximum reaction time (ms)

$$\begin{aligned}
 &= \text{Switch reaction time} \\
 &\quad + \text{NE1A-series Controller-A local input/remote output reaction time} \\
 &\quad + \text{Network reaction time} \\
 &\quad + \text{NE1A-series Controller-B remote input/local output reaction time} \\
 &\quad + \text{Actuator reaction time} \\
 &= \text{Switch reaction time} \\
 &\quad + \text{ON/OFF delay (NE1A-series Controller) } + 6 + 6 \times 2 \\
 &\quad + 28 \\
 &\quad + 7 + 2.5 \\
 &\quad + \text{Actuator reaction time} \\
 &= \underline{\underline{55.5 + \text{ON/OFF delay} + \text{Switch reaction time} + \text{Actuator reaction time}}}
 \end{aligned}$$

2-3-3 Verifying the Maximum Reaction Time

Check that the calculated maximum reaction time meets the required specifications in all safety chains. If the reaction time exceeds the required specifications, re-examine the network design, taking into consideration the following points for the maximum reaction time to meet the requirement specifications:

- Shortening the EPI will shorten the network reaction time. Shortening the EPI, however, narrows the network bandwidth that can be used for other connections.
- The NE1A-series Controller cycle time is automatically calculated based on the program size, the number of connections, etc. It is also possible to use different NE1A-series Controller Controllers for safety chains that require a high-speed reaction time and other safety chains.

SECTION 3

Basic Operation of the Network Configurator

3-1	Installation	39
3-1-1	Installing the Network Configurator	39
3-1-2	Installing the USB Driver	41
3-2	Network Configurator Startup and Main Window	49
3-2-1	Starting and Exiting the Network Configurator	49
3-2-2	Checking the Version	50
3-2-3	Main Window	51
3-3	Menu List	52
3-3-1	File Menu	52
3-3-2	Edit Menu	52
3-3-3	View Menu	52
3-3-4	Network Menu	53
3-3-5	Device Menu	55
3-3-6	EDS File Menu	56
3-3-7	Tools Menu	56
3-3-8	Option Menu	56
3-3-9	Help Menu	57
3-3-10	Main Window Display Modes	57
3-4	Connecting to the Network	62
3-4-1	Network Connection via USB Port	62
3-4-2	Network Connection via DeviceNet Interface Card	63
3-4-3	Network Connection via Ethernet	64
3-4-4	Connecting to a Network	65
3-4-5	Changing a Connected Network	67
3-5	Creating a Virtual Network	68
3-5-1	Creating a New Virtual Network	68
3-5-2	Network Numbers	68
3-5-3	Adding Devices	71
3-5-4	Deleting Devices	76
3-5-5	Changing the Node Address or IP Address	76
3-5-6	Changing Device Comments	76
3-5-7	Creating a Connected Network from a Device	77
3-6	Saving and Reading Network Configuration Files	79
3-6-1	Password Protection of the Network Configuration File	79
3-6-2	Saving the Network Configuration File	80
3-6-3	Reading a Network Configuration File	80
3-6-4	Protect Mode	81

3-7	Device Password Protection	82
3-7-1	Setting a Device Password	82
3-7-2	Forgotten Device Passwords	83
3-8	Device Parameters and Properties	84
3-8-1	Editing Device Parameters	84
3-8-2	Uploading Device Parameters	84
3-8-3	Downloading Device Parameters	85
3-8-4	Device Properties	89
3-9	Parameter Verification	92
3-9-1	Device Parameter Verification	92
3-10	Configuration Lock	96
3-10-1	Locking the Device Configuration	96
3-10-2	Unlocking the Device Configuration	97
3-11	Device Reset and Status Change	98
3-11-1	Reset Types	98
3-11-2	Resetting Devices	99
3-11-3	Reset Types and Device Status	100
3-11-4	Changing Device Status	100

3-1 Installation

3-1-1 Installing the Network Configurator

Preparing for Installation

Check the following items before beginning with the installation.

■ Available Hard Disk Space

The Network Configurator can be installed on the hard disk only. At least 200 MB of hard disk space is required. Make sure that there is enough space available.

■ Windows Environment and Installation Folder

The Network Configurator is a software application for a Windows operating environment. The software is installed on top of Windows. Make sure that Windows is installed and functioning correctly on the computer. Also, make sure that you are logged onto the computer as a user with administrator rights.

Note With version 3.3□ or higher, if Network Configurator version 3 has already been installed from a different package, such as the CX-One, then the previous installation is updated.

Installation Precautions

- If Network Configurator version 3 has already been installed from a different package, such as the CX-One, then the previous installation is updated. Files will be installed in the same folder as the one used by the previous package to upgrade functionality.
- If you install the software again from the CX-One after installing the Network Configurator, installation of Network Configurator for EtherNet/IP will overwrite some of the files. As a result, some problems will occur, e.g., some devices will not be displayed in the Hardware List Pane. These problems can be solved by applying a patch. Execute the \Utility\CX-One_Update\Ntc****_****Setup_for_Safety.exe files (where * indicates any number) in the Network Configurator Master Disk and install the patch according to the instructions from the installer.

Installation Procedure

- 1,2,3...**
1. Insert the Network Configurator Master Disk into the CD-ROM drive. Open the CD-ROM drive from the Explorer and execute the setup.exe file.
 2. Complete the installation process following the instructions provided on-screen.

Note You can specify the installation folder for the Network Configurator during the installation. However, with version 3.3□ or higher, if Network Configurator version 3 has already been installed from a different package, such as the CX-One, then the previous installation is updated and you cannot change the installation folder.

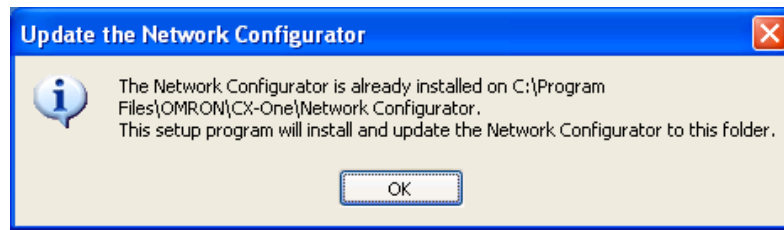

Uninstalling the Network Configurator

Uninstall the Network Configurator when it is no longer required. Use **Programs and Features (Add or Remove Programs** for Windows XP) from the Windows Control Panel to uninstall the Network Configurator.

3-1-2 Installing the USB Driver

You must install the USB driver to go online with the NE1A-series or NE0A-series Controller via USB.

Preparing for Installation

Check the following items before beginning with the installation.

■ Connection to a Safety Network Controller

Turn ON the power supply to the Safety Network Controller (NE1A or NE0A) and then use a USB cable to connect the USB port on the Safety Network Controller to the USB port on a computer on which the Network Configurator has already been installed.

■ Windows Environment

Make sure that you are logged onto the computer as a user with administrator rights.

Installing on Windows XP

Operating Procedure

- 1,2,3... 1. The computer will automatically detect the Safety Network Controller when the cable is connected and display a message saying that new hardware has been detected. The Found New Hardware Wizard will be displayed.

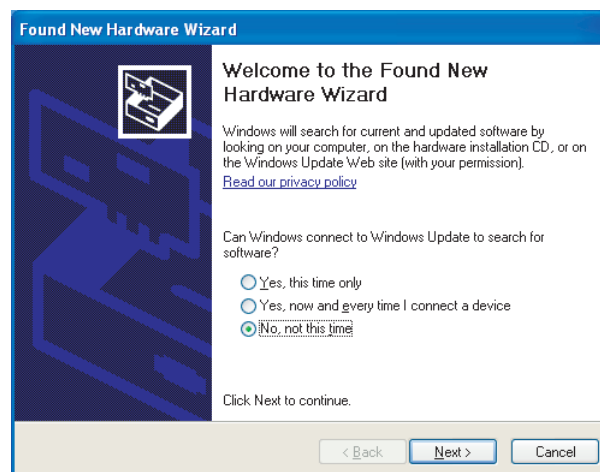

In the Found New Hardware Wizard Dialog Box, select the *No, not this time* option and click the **Next** Button.

2. Select the *Install from a list or specific location (Advanced)* Option and click the **Next** Button.

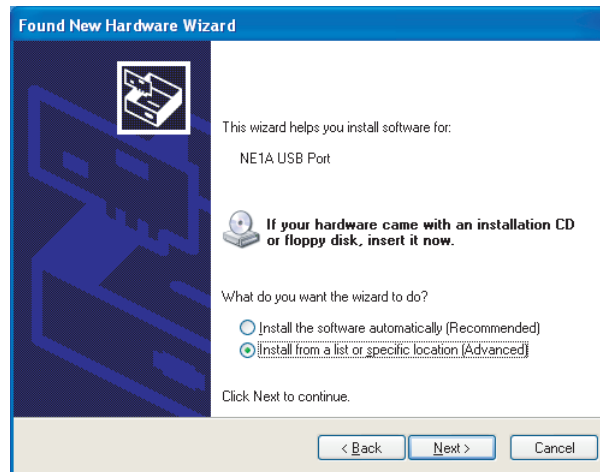

3. Select the *Search the best driver in these locations* Check Box and select the *Include this location in the search* Option. Click the **Browse** Button, select the `\SafetyDrivers\USB` folder in the folder in which the Network Configurator was installed or the `\drivers\USB` folder in the Network Configurator Master Disk (CD-ROM), and then click the **Next** Button.

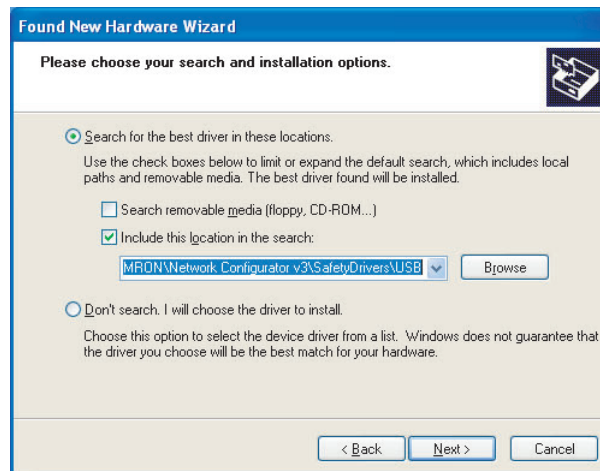

4. If a warning message appears saying that the driver has not passed the Windows logo test, ignore it and click the **Continue Anyway** Button.

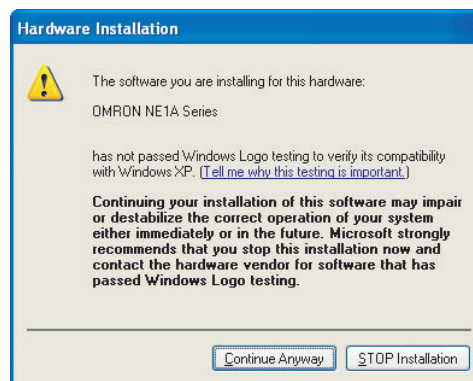

- When the driver installation is completed normally, the following dialog box will be displayed. Click the **Finish** Button.

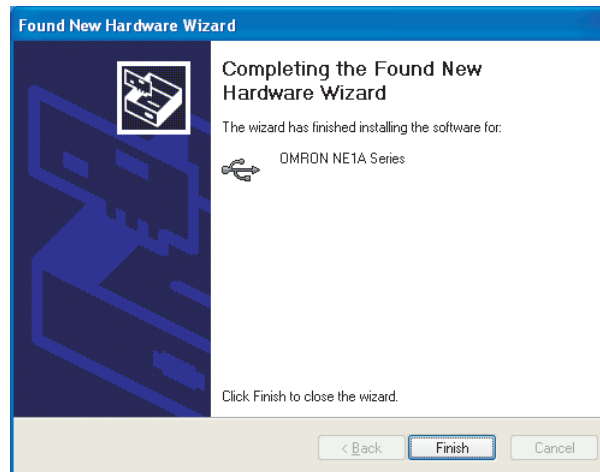

- The Found New Hardware Wizard Dialog Box will be displayed again. Perform the installation using the procedure in step 1-5.

Note If an NE1A-series or NE0A-series Controller is connected to a computer on which the driver has been installed only once, the Found New Hardware Wizard Dialog Box will be displayed again. If it is displayed, select the *Search for a suitable driver for my device (recommended)* Option and then continue with the procedure.

Installing on Windows Vista

Operating Procedure

- 1,2,3...** 1. When the computer detects the Safety Network Controller, the Found New Hardware Dialog Box will be displayed. Select the *Locate and install driver software (recommended)* Option.

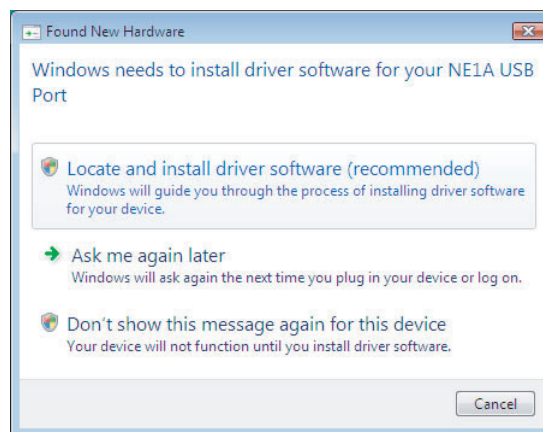

2. If the following dialog box is displayed, select the *Don't search online* Option.

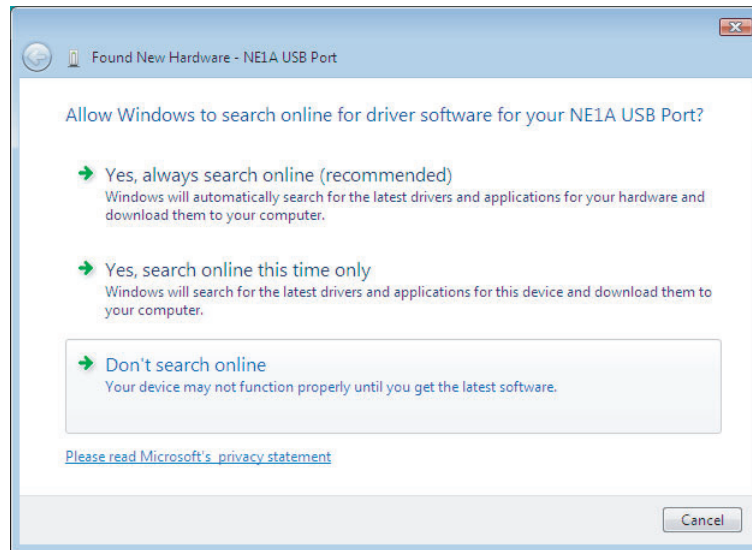

3. Select the following: *I don't have the disc. Show me other options.*

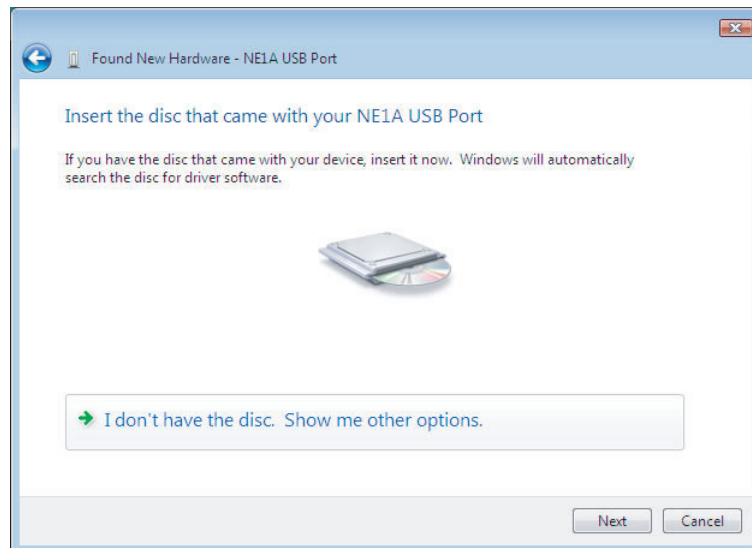

- 4. Select the *Browse my computer for driver software (advanced)* Option.

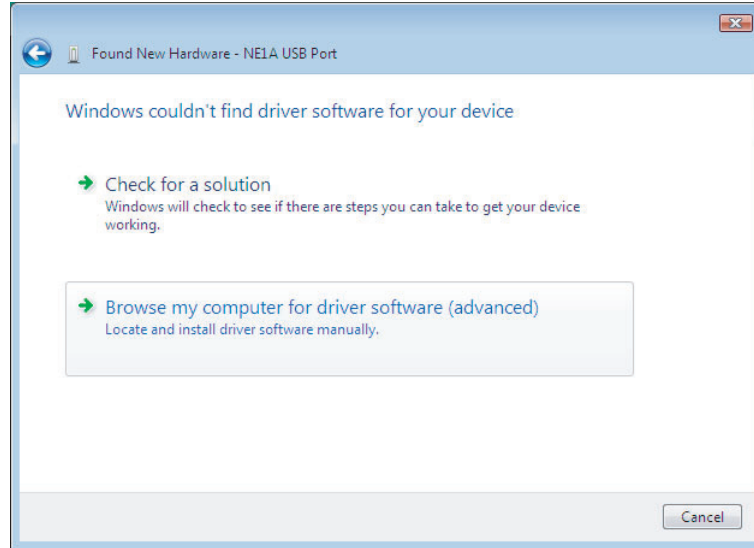

- 5. Under *Search for driver software in this location*, click the **Browse** Button, select the `\SafetyDrivers\USB` folder in the folder in which the Network Configurator was installed or the `\drivers\USB` folder in the Network Configurator Master Disk (CD-ROM), and the click the **Next** Button.

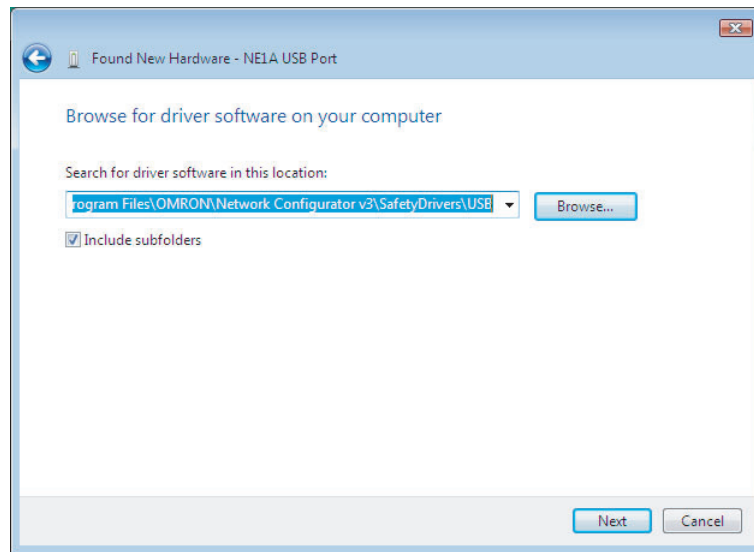

- 6. The Windows Security Dialog Box will be displayed. Click the **Install** Button.

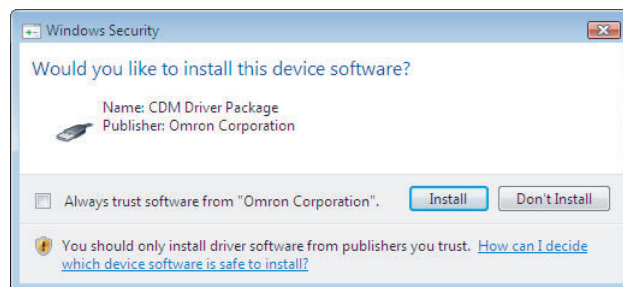

7. When the driver installation is completed normally, the following dialog box will be displayed. Click the **Close** Button.

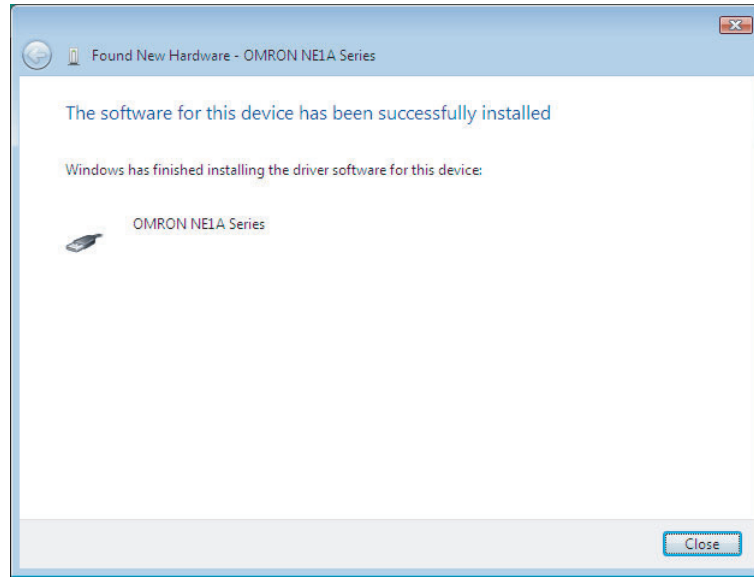

8. The Found New Hardware Dialog Box will be displayed again. Perform the installation using the procedure in step 2-7.

Installing on Windows 7/8/8.1/10

Operating Procedure

- 1,2,3... 1. Open the Control Panel from the Windows Start Menu and then select **Device Manager**.
2. Right-click **NE1A USB Port** or **NE0A USB Port** under *Other Devices*, and then select **Update Driver Software**.

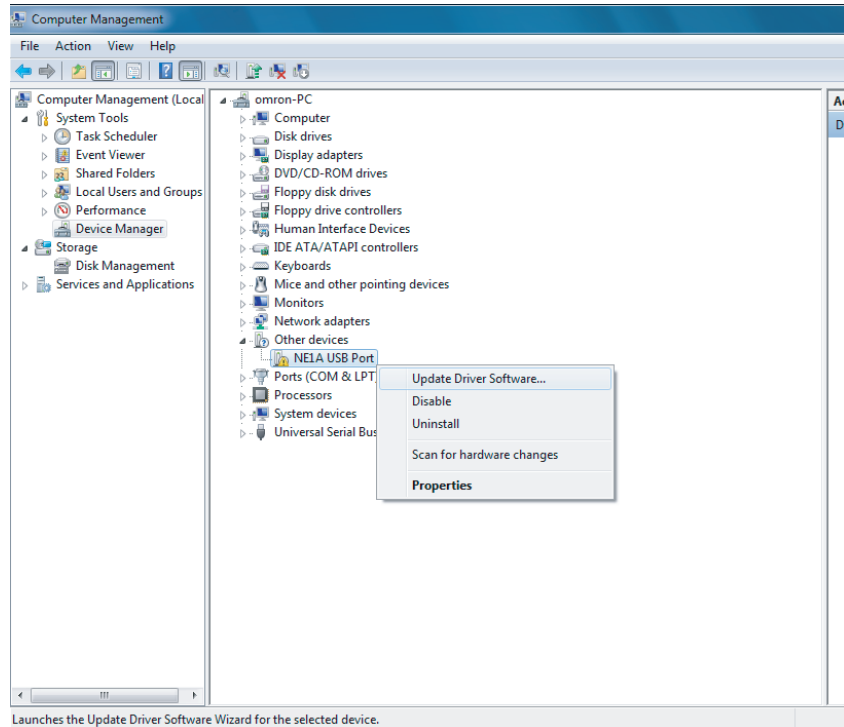

3. The Update Driver Software Dialog Box will be displayed. Select the *Browse my computer for driver software* Option.

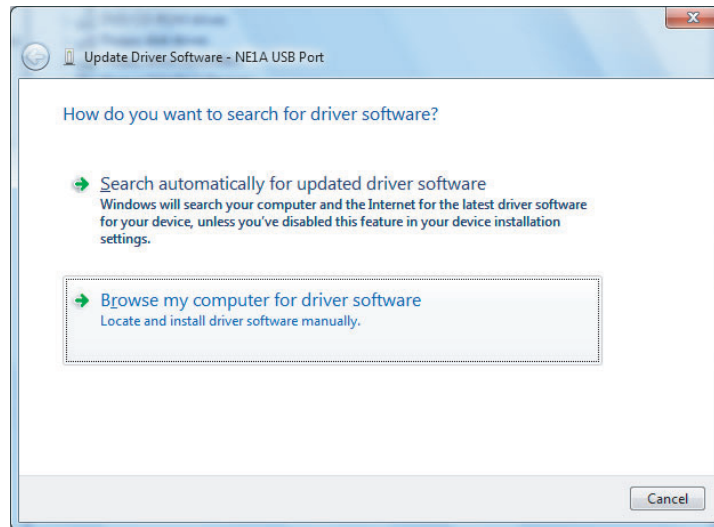

4. Under *Search for driver software in this location*, click the **Browse** Button, select the `\SafetyDrivers\USB` folder in the folder in which the Network Configurator was installed or the `\drivers\USB` folder in the Network Configurator Master Disk (CD-ROM), and the click the **Next** Button.

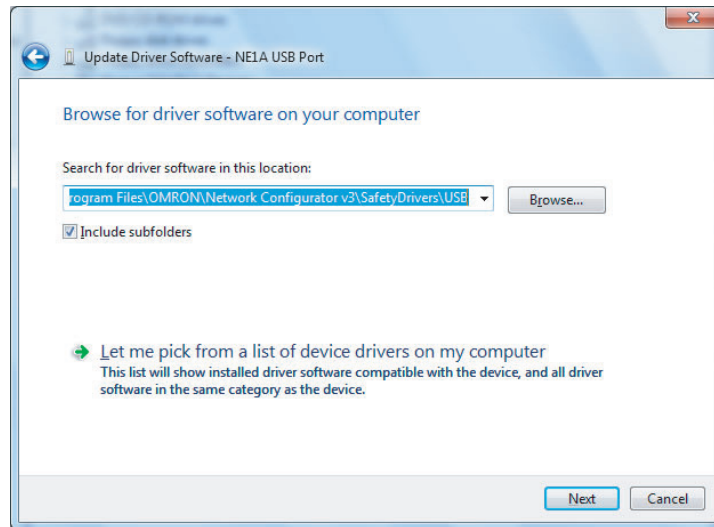

5. The Windows Security Dialog Box will be displayed. Click the **Install** Button.

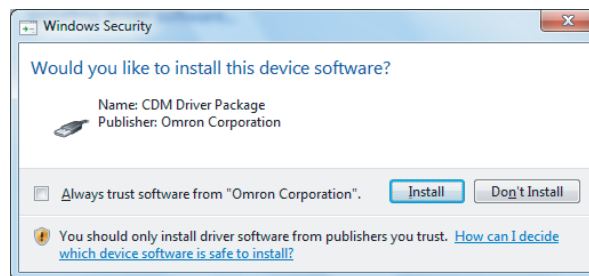

6. When the driver installation is completed normally, the following dialog box will be displayed. Click the **Close** Button.

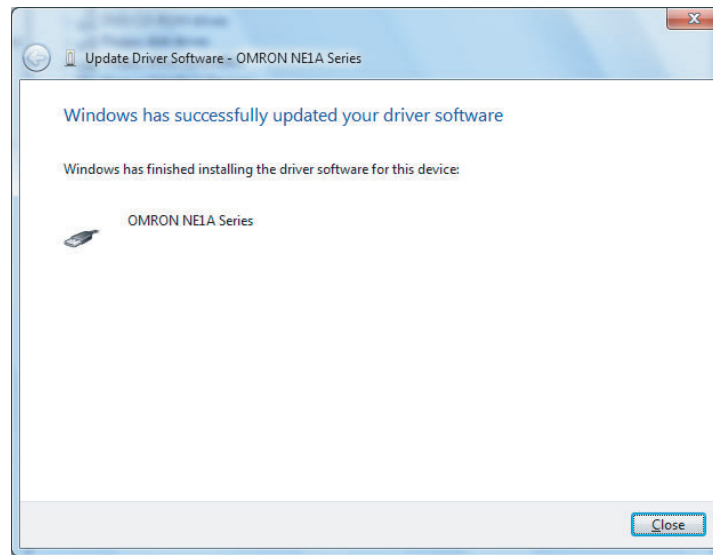

7. Repeat step 1-2. *USB Serial Port* will be displayed under *Other Devices*. Perform the installation using the procedure in step 2-6.

3-2 Network Configurator Startup and Main Window

This section describes methods for starting and exiting the Network Configurator, describes how to check the Network Configurator version and describes the Main Window.

3-2-1 Starting and Exiting the Network Configurator

Starting

Select **Program -OMRON Network Configurator for DeviceNet Safety - Network Configurator** from the Windows Start Menu (when using the default program folder name).

The Network Configurator will start, and the following window will be displayed.

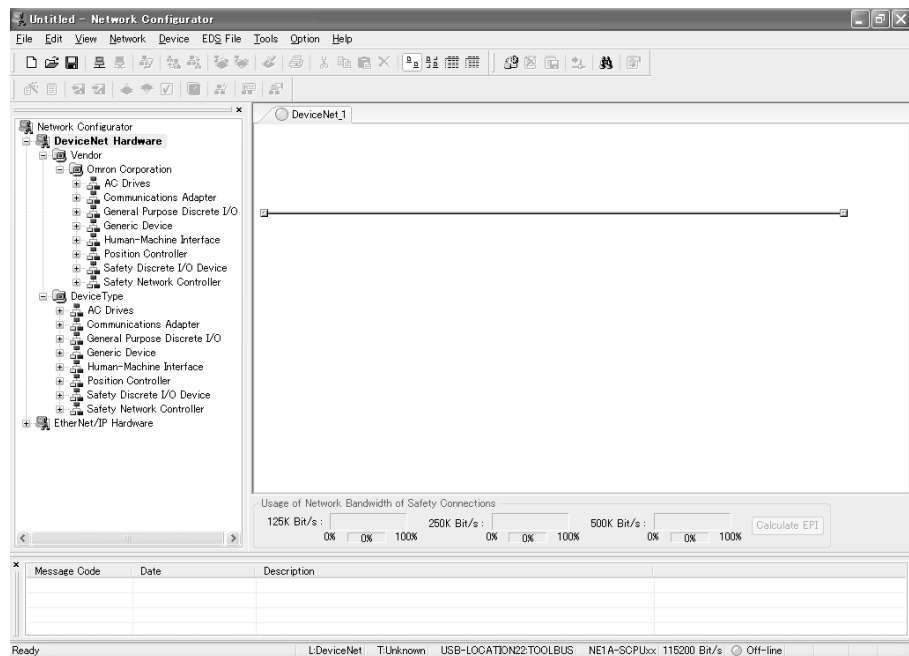

Exiting

Select **File -Exit** in the Main Window.

The Network Configurator will close.

3-2-2 Checking the Version

The procedure to check the Network Configurator version is as follows:

Windows XP or Windows 2000

1. For Windows XP, select **Control Panel - Add or Remove Programs** from the Windows Start Menu.
For Windows 2000, select **Setting - Control Panel - Add/Remove Programs** from the Windows Start Menu.
2. Select the **Network Configurator for DeviceNet Safety** from the installed program list, and then refer to the support information by following each display.

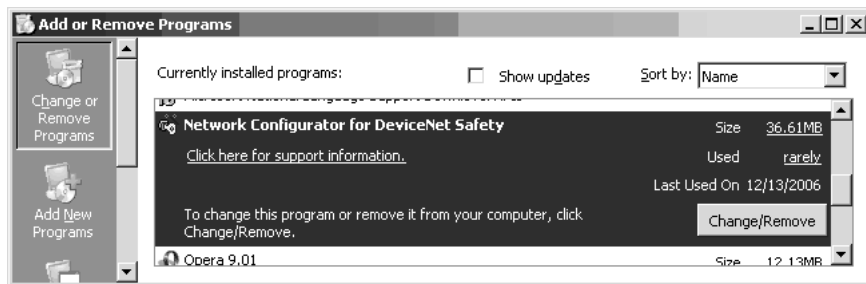

3. The version will be displayed as support information.



Windows Vista or a Later Version

1. Select **Control Panel - Programs** from the Start Menu.
2. Select **Network Configurator for DeviceNet Safety** from the list of installed programs.
The version is displayed in the details pane.

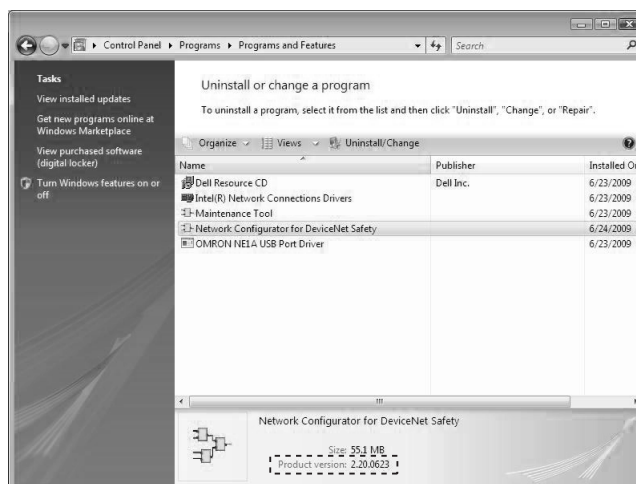

3-2-3 Main Window

The Main Window consists of the Hardware List, the Network Configuration Pane, Maintenance Pane, and the Message Pane.

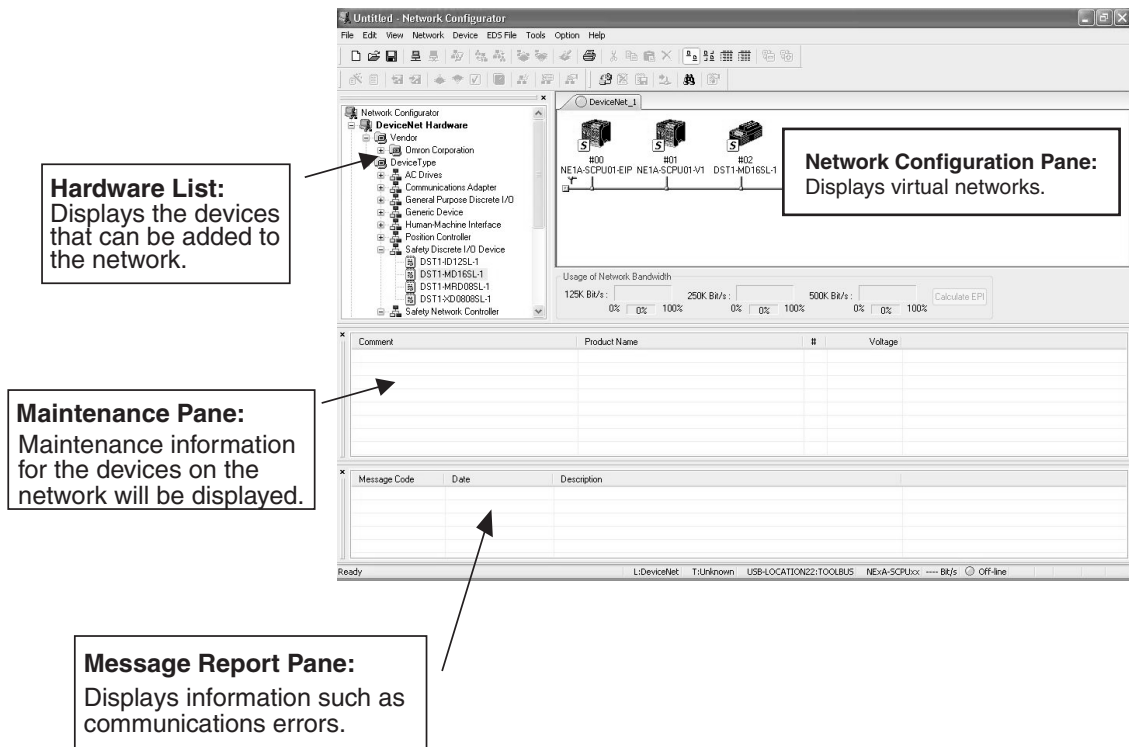

3-3 Menu List

This section describes the function of each menu command of the Network Configurator.

“Online” is the state in which the Network Configurator is connected to the network. “Offline” is the state in which the Network Configurator is disconnected from the network.

3-3-1 File Menu

O: Supported x: Not supported

Submenu		Description	Offline	Online
New		Creates a new network configuration.	O	O
Open		Opens an existing network configuration file.	O	O
Save		Saves the current network configuration to a file.	O	O
Save As		Names and saves the current network configuration. You can also use this command on version 3.3□ or higher to save a network configuration file in a format that can be used on version 2.	O	O
External Data	Export Device List Export	Exports in CSV format a file with the contents displayed in the detailed display.	O	O
	Export	Exports a network configuration file that can be used with Network Configurator version 2.	O	O
	Import	Imports a network configuration file created in DeviceNet Configurator version 1 or version 2.	O	O
Change Password		Changes the password of the network configuration file. Refer to <i>3-6-1 Password Protection of the Network Configuration File</i> .	O	O
Report		Creates a report on a specified device. Refer to <i>3-9 Parameter Verification</i> .	O	O
Print		Prints the device parameters and I/O comment list. (Use the report function to print information for a safety device.)	O	O
Setup Printer		Sets up the printer.	O	O
Exit		Exits the Configurator.	O	O

3-3-2 Edit Menu

Submenu	Description	Offline	Online
Cut	Deletes selected devices and copies them to the clipboard.	O	O
Copy	Copies selected devices to the clipboard.	O	O
Paste	Pastes a device on the clipboard to the cursor position.	O	O
Delete	Deletes selected devices.	O	O
Select All	Selects all the devices.	O	O
Clear Message Report	Clears a message in the Message Pane.	O	O

3-3-3 View Menu

Submenu	Description	Offline	Online
Toolbar	Displays or hides the toolbar.	O	O
Status Bar	Displays or hides the status bar.	O	O
Message Report	Displays or hides the Message Pane.	O	O
Maintenance	Displays or hides the Maintenance Pane.	O	O
Large Icons	Switches to network display. Refer to <i>3-3-10 Main Window Display Modes</i> .	O	O
Large Icons - Maintenance Mode	Displays or hides maintenance information. Refer to <i>3-3-10 Main Window Display Modes</i> .	O	O

Submenu	Description	Offline	Online
Display Mode 1	Switches to the detailed display mode 1, which displays the configuration based on the master device. Refer to 3-3-10 Main Window Display Modes.	○	○
Display Mode 2	Switches to the detailed display mode 2, which displays the configuration based on the slave devices. Refer to 3-3-10 Main Window Display Modes.	○	○
Open All Devices	Displays all of the devices set for communications with the device that the configuration is based on. This function can be used only in Detailed Display Mode 1 or 2.	○	○
Close All Devices	Hides all of the devices set for communications with the device that the configuration is based on. This function can be used only in Detailed Display Mode 1 or 2.	○	○
Hardware List	Displays or hides the Hardware List.	○	○
Network Structure	Displays or hides the Network Configuration Window. Refer to <i>Network Structure</i> in 3-3-10 Main Window Display Modes.	○	○

3-3-4 Network Menu

Submenu	Description	Offline	Online	
Connect	Connects the Network Configurator to the network. Refer to 3-4 Connecting to the Network.	○	×	
Disconnect	Disconnects the Network Configurator from the network. Refer to 3-4 Connecting to the Network.	×	○	
Change Connect Network Port	Changes the destination network port. Refer to 3-4-5 Changing a Connected Network.	×	○	
Move Network	Switches the network to connect. (Not normally used for DeviceNet Safety.)	×	○	
Wireless Network	Move to Upper Network	Displays the network one layer above the current network in the wireless networks. (Not normally used for DeviceNet Safety.)	×	○
	Move to Lower Network	Displays the network one layer below the current network in the wireless networks. (Not normally used for DeviceNet Safety.)	×	○
Upload	Uploads all the device parameters in the network to the Network Configurator. Refer to <i>Uploading the Network Configuration from the Actual Network (Network Upload)</i> in 3-5 Creating a Virtual Network.	×	○	
Download	Downloads all the device parameters in the Network Configurator to the devices in the network. Refer to 3-8-3 Downloading Device Parameters.	×	○	
Verify Structure	Verifies the current network configuration in the Network Configurator with the actual network configuration of the destination online connection.	×	○	
I/O Connection	Start	Establishes an I/O connection for the specified device. (Can be used only with EtherNet/IP.)	×	○
	Stop	Stops the I/O connection for the specified device. (Can be used only with EtherNet/IP.)	×	○
Update Maintenance Information	Updates the maintenance information of each device to the latest information.	×	○	
Update Device Status	Updates the status information for each device to the most recently updated information.	×	○	
View Device's Connection Structure Tree	Displays the connection configuration of the entire system. Refer to <i>Device's Connection Structure Tree Display</i> in 3-3-10 Main Window Display Modes.	○	○	
Check Connection	Checks the consistency of all the connections.	○	○	
Edit All Connections	Makes batch settings for all connections in the system. Refer to 5-1-4 Listing and Setting Connection Parameters.	○	○	

Submenu		Description	Offline	Online
Add	DeviceNet	Adds a DeviceNet network in the Network Configuration Window.	<input type="radio"/>	<input type="radio"/>
	EtherNet/IP	Adds an EtherNet/IP network in the Network Configuration Window.	<input type="radio"/>	<input type="radio"/>
Copy		Copies the selected network configuration.	<input type="radio"/>	<input type="radio"/>
Delete		Deletes the selected network configuration.	<input type="radio"/>	<input type="radio"/>
Change View		Switches the displayed network.	<input type="radio"/>	<input type="radio"/>
Property		Displays the network properties. The network name and safety network number can be set. This function can also get network numbers from actual networks. This function is enabled only when on online.	<input type="radio"/>	<input type="radio"/>

3-3-5 Device Menu

Submenu		Description	Offline	Online
Parameter	Wizard	Configures the device parameters in a wizard format. This function is not supported by all devices.	○	○
	Edit	Edits the device parameters.	○	○
	Read	Reads the parameters from the device parameter file.	○	○
	Save As	Saves the device parameters to a file.	○	○
	Upload	Uploads the device parameters from a device in the network.		
	Download	Downloads the device parameters to a device in the network.		
	Verify	Verifies the device and the device parameters in the network.	×	○
	Lock	Locks the configuration of a device in the network. Refer to 3-10-1 <i>Locking the Device Configuration</i> .	×	○
	Unlock	Unlocks the locked configuration of a device in the network. Refer to 3-10-2 <i>Unlocking the Device Configuration</i> .	×	○
Monitor	Monitors the parameters and status of a device in the network. Not all devices support this function.	×	○	
Reset	Resets a device in the network. Refer to 3-11 <i>Device Reset and Status Change</i> .	×	○	
Change Mode	Changes the status of a device in the network. Not all devices support this function. Refer to 3-11-4 <i>Changing Device Status</i> .	×	○	
Change Password	Changes the password of a device in the network. Refer to 3-7 <i>Device Password Protection</i> .	×	○	
Set TUNID	Sets the TUNIDs for network devices. (Version 3.3□ or higher)	×	○	
Maintenance Information	Displays the maintenance information of a device in the network. This function is enabled only for devices that support it.	×	○	
Register to Another Device	Registers a device to another device.	○	○	
External Data	Export	Exports I/O comments or device parameters to another file format. Not all devices support this function.	○	○
	Import	Imports a device parameter file created with DeviceNet Configurator (version 1 or version 2). Not all devices support this function.	○	○
Change Node Address	Changes a device node address.	○	○	
Change Device Comment	Changes a device name.	○	○	
Change Device	Converts the NE1A-series Controller models in a network configuration file to higher models.	○	○	
Edit I/O Comment	Edits the I/O comment.	○	○	
Identity Synchronization	Acquires identity information from a device and save it to a file.	×	○	
Register To Routing Network	Creates a new network (or selects from existing networks) and specifies the routing destination network.	○	○	
Display Routing Network	Displays the routing network if a device that supports routing is selected (NE1A-SCPU01-EIP, NE1A-SCPU02-EIP, or NE1A-EDR01).	○	○	
Property	Displays the properties of a device.	○	○	

Note The Device Menu and Edit Menu can be partially displayed by right-clicking in the Network Configuration Pane.

3-3-6 EDS File Menu

Submenu	Description	Offline	Online
Install	Installs an EDS file and adds a device to the Hardware List. (Normally there is no need to install the EDS files.)	○	○
Create	Creates a new EDS file and adds a device to the Hardware List.	○	○
Delete	Deletes a device from the Hardware List. The installed EDS file is also deleted.	○	○
Save As	Names and saves the EDS file of a device on the Hardware List.	○	○
Find	Searches for a specified EDS file from the Hardware List.	○	○
Add to Network	Adds a device on the Hardware List to the virtual network.	○	○
Property	Displays the properties of an EDS file.	○	○
Create EDS Index File	Recreates an EDS index file. If the devices are not correctly displayed in the Hardware List Pane, restart the Network Configurator. (Version 3.3□ or higher)	○	○

Note Start the Network Configurator as a user with administrator rights to install, create, or delete EDS files or create EDS index files.

- On Windows XP, the above operations cannot be performed by a user that does not have administrator rights.
- On Windows Vista or a later version, operations that are performed when the Network Configurator is started normally are not applied for other user accounts (including the administrator).

The EDS File Menu can be displayed by right-clicking in the Hardware List Window.

3-3-7 Tools Menu

Submenu	Description	Offline	Online
Setup Parameters	Sets parameters by using explicit message communications.	×	○
Setup Node Address/Baud Rate (only when DeviceNet is selected)	Sets the node address or baud rate of a device in the DeviceNet network.	×	○
Setup TCP/IP Configuration (only when EtherNet/IP is selected)	Makes TCP/IP settings, such as the IP address and subnet mask of a device on the EtherNet/IP network.	×	○

3-3-8 Option Menu

Submenu	Description	Offline	Online
Select Interface	Selects an interface for the Network Configurator to use for the network connection.	○	×
Edit Configuration File	Edits various configuration files. (Normally not required.)	○	○
Setup Monitor Refresh Timer	Sets the monitor refresh timer values (monitoring cycles in device monitoring).	○	○
Install Extend Module	Installs an Expansion Module. (Normally not required.)	○	○
Install Interface Module	Installs an Interface Module. (Normally not required.)	○	×

Parameter Auto Update when Configuration Changed	The slave parameters registered in the Master will be updated automatically when a slave parameter is changed. The default is OFF (do not update). Under normal conditions, leave this option set to OFF. If slave information registered in the Master does not match with the slave information, an exclamation mark [!] will be displayed below the device icon. (Refer to 2-1-2 Changing an Established Safety Network.)	<input type="radio"/>	<input type="radio"/>
Device Status Auto Update When Connected Online	When this option is ON, if the device is online, its status will be automatically detected and displayed.	<input type="radio"/>	<input checked="" type="radio"/>

Note Start the Network Configurator as a user with administrator rights to edit configuration files, install expansion modules, or install interface modules.

- On Windows XP, the above operations cannot be performed by a user that does not have administrator rights.
- On Windows Vista or a later version, operations that are performed when the Network Configurator is started normally are not applied for other user accounts (including the administrator).

3-3-9 Help Menu

Submenu	Description	Offline	Online
Topic	Searches the help topics.	<input type="radio"/>	<input type="radio"/>
About	Displays the version information of the Network Configurator.	<input type="radio"/>	<input type="radio"/>

3-3-10 Main Window Display Modes

The Main Window display can be changed. Any of the following display modes can be selected: Communications Mode, Maintenance Mode, Detailed Display 1, Detailed Display 2, Network Configuration Window, or Device's Connection Structure Tree.

Communications Mode

This is the normal display mode. A device list, node addresses, and device names are displayed.

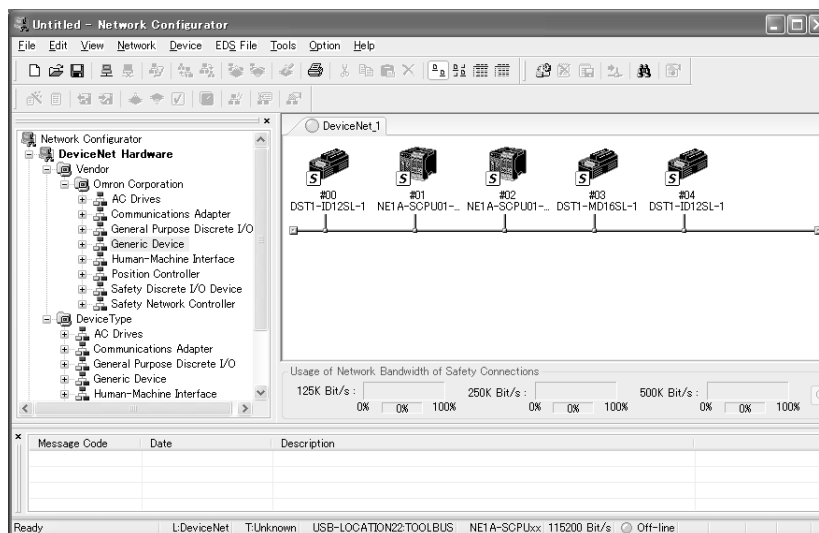

Maintenance Mode

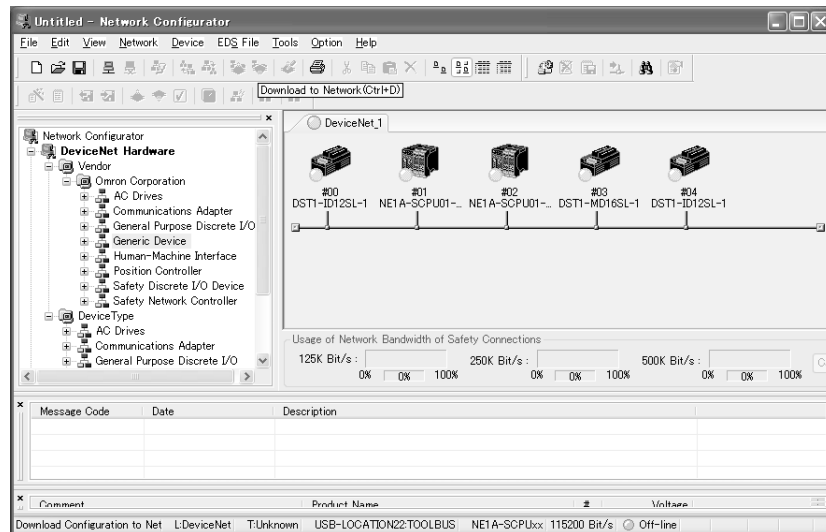

In this mode, in addition to the information displayed in Communications Mode, the devices required for maintenance can be checked at a glance and device status can be displayed at the same time.

Detailed Display 1 (Based on Master Devices)

The following items are displayed in list format in this mode: Comments added to devices, device names, node addresses, device node addresses registered to master devices, header names, device types, product names, and revisions.

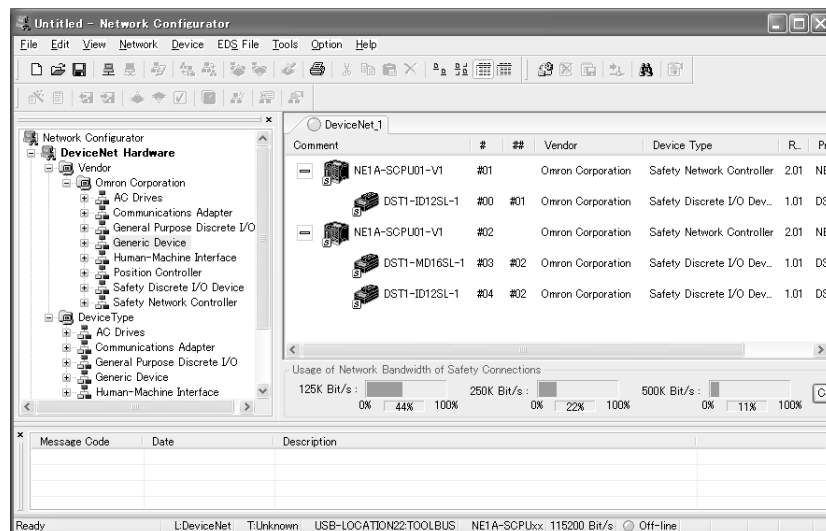

Detailed Display 2 (Based on Slave Devices)

The following items are displayed in list format in this mode: Comments attached to devices, device names, MAC IDs, device MAC IDs registered to slave devices, header names, device types, product names, and revisions.

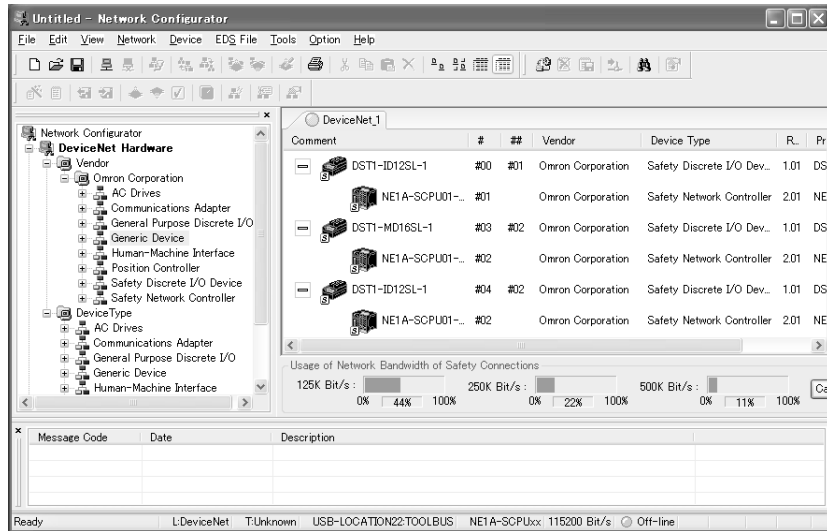

Network Structure



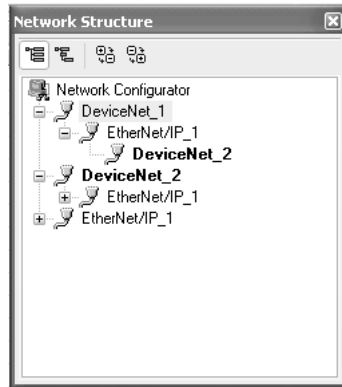

Select **View - Network Structure** to display the following window.



This window displays a list of virtual networks created with the Network Configurator and the structure of those networks. Double-click the network name to switch the Main Window display to the corresponding network.

The toolbar at the top of the Network Structure Window includes the following functions.



Icon	Description
	Hide router devices. Hides router devices in the network structure list.
	Display router devices. Displays router devices in the network structure list.
	Open all. Opens items displayed in trees and displays all items.
	Close all. Closes items displayed in trees and displays only the top network.

Note An exclamation mark [!] may be displayed below the device icon on the Network Configurator. This indicates that the information in the Slave and the information in the Master do not match.

If an exclamation mark is displayed, update the information by opening the Property Dialog Box of the Master that the Slave is registered with. (If the Slave is registered with the Standard Master, check the Standard Master.)



Device's Connection Structure Tree Display

Select **Network - Device's Connection Structure Tree** to display the following window.

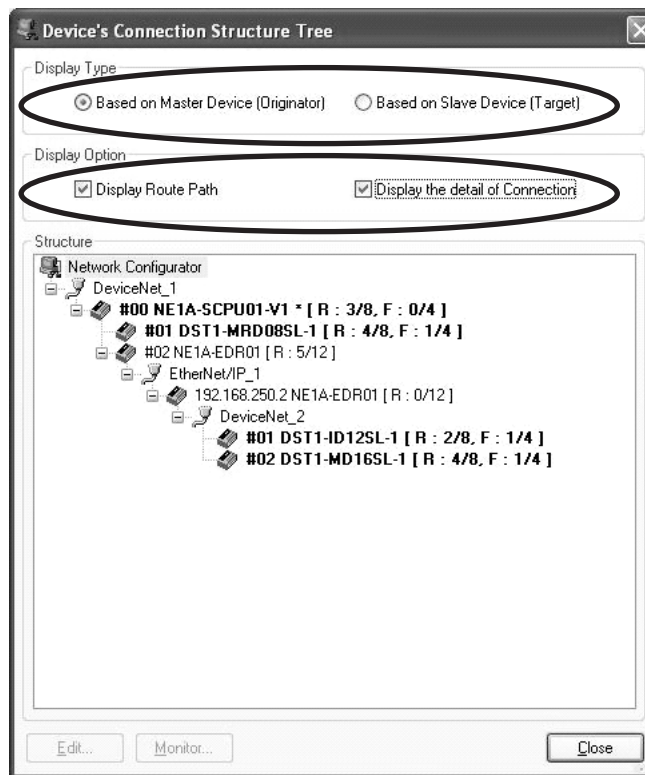

This window displays a list of the networks. Under each network is displayed a list of master devices in that network. The devices registered to a master device and displayed under the master device. Registered devices can also be displayed in the same way via the NE1A-EDR01.

The display type can be switched between the master device-based mode (displaying devices connected to master devices) and the slave device-based mode (displaying devices connected to slave devices).

In addition, the *Display Route Path* and *Display Connection Details* are supported as display options.

Select the *Display Route Path* option to display a route (EtherNet/IP if registered via the NE1A-EDR01).

If the *Display Route Path* option is not selected, only the networks on which master devices and slave devices exist will be displayed, and not the route.

If the *Display Connection Details* option is selected, an asterisk (*) is displayed at the connected master device.

“R” and “F” indicate the number of resources required for communications.

“R” indicates the number of communications resources required by each device. “F” indicates the number of communications required by each device. Users do not normally need to be aware of these values because they are calculated automatically by the Network Configurator.

3-4 Connecting to the Network

The Network Configurator must be connected to the network to perform operations that are valid only when online, such as obtaining the network configuration from an actual network or downloading the configured device parameters to actual devices.

This section describes the procedure for connecting to the network via the USB port on the NE1A-series Controller, a DeviceNet Interface Card installed in a computer, and Ethernet (only when using the NE1A-SCPU01-EIP, NE1A-SCPU02-EIP, or NE1A-EDR01).

Refer to the Appendix for other network connection procedures.

3-4-1 Network Connection via USB Port

1. Turn ON the power supply to the NE1A-series Controller and connect it to a USB port on the computer.
2. Select **Option - Select Interface - NEXA USB Port** followed by the desired mode from the menu bar.
3. Select **Network - Connect** from the menu bar.

The Select Connect Network Port Dialog Box will be displayed.

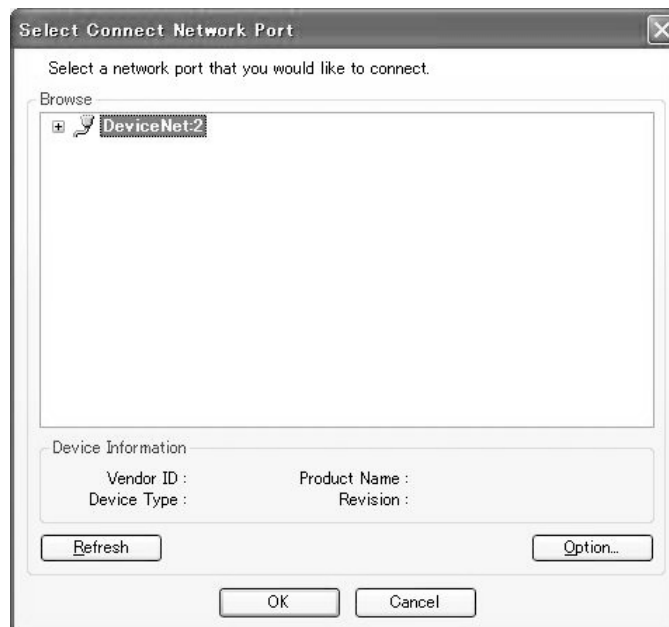

When connecting to a network for the first time, this dialog box will be displayed and a network search will be performed automatically. Wait until the search has been performed for all addresses. After the search, the networks that can be connected will be displayed.

From the second time onwards, the network search will not be performed automatically.

4. Select the network to connect to and click the **OK** Button.

If an online connection is made normally, *On-line* will be displayed in the status bar at the bottom of the window.

3-4-2 Network Connection via DeviceNet Interface Card

The DeviceNet Interface Card is not compatible with 64-bit operating systems.

1. Select **Option - Select Interface - DeviceNet I/F**.
2. Select **Network - Connect**.

The Select Interface Dialog Box will be displayed.

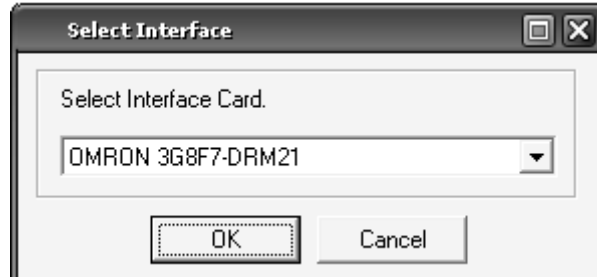

3. Select the interface card, and click the **OK** Button.

The Setup Interface Dialog Box will be displayed.

This window varies depending on the type of interface card. In this example, a DeviceNet PCMCIA Card (3G8E2-DRM21-V1) is used. If you use another interface card, refer to the operation manual for the card.

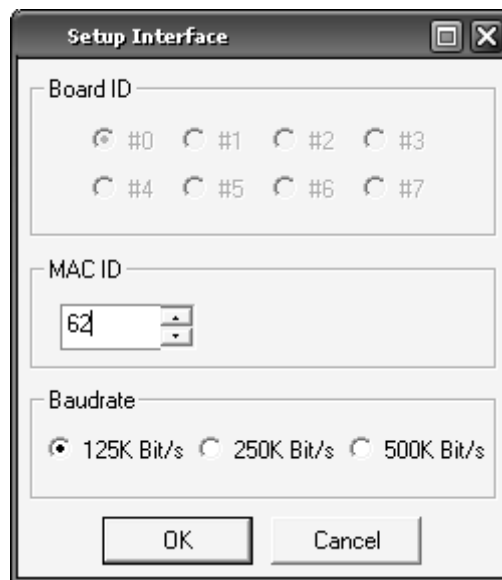

4. Set the MAC ID (node address) and baud rate, and click the **OK** Button.
The Select Connect Network Port Dialog Box will be displayed.

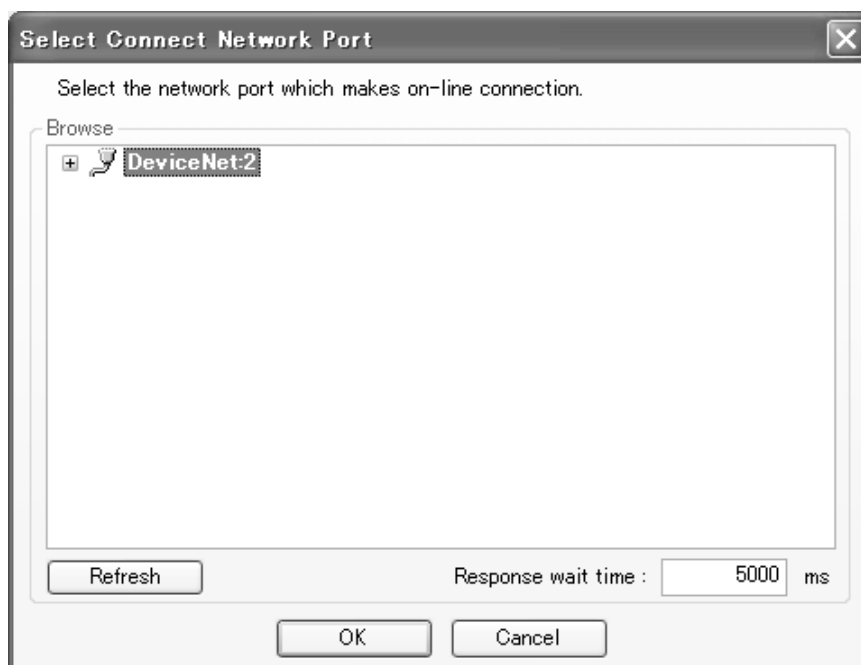

In the first network connection, a network search is performed automatically with this dialog box displayed. Wait until the search has been performed for all addresses. After the search, the networks that can be connected will be displayed.

Automatic searching for networks will not be performed the second time or after.

5. Select the network to connect to, and click the **OK** Button.

If an online connection is made normally, *On-line* will be displayed in the status bar at the bottom of the window.

3-4-3 Network Connection via Ethernet

This section describes the procedures for connecting to the network via Ethernet (enabled only when using the NE1A-SCPU01-EIP, NE1A-SCPU02-EIP, or NE1A-EDR01).

1. Select **Option - Select Interface**.
2. Select **Network - Connect**.
The Select Interface Dialog Box will be displayed.

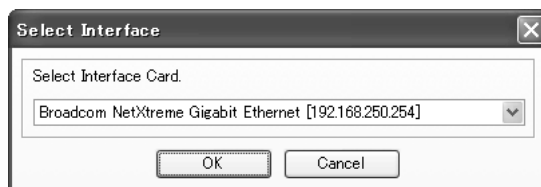

3. Click the **OK** Button.
The Select Connect Network Port Dialog Box will be displayed.

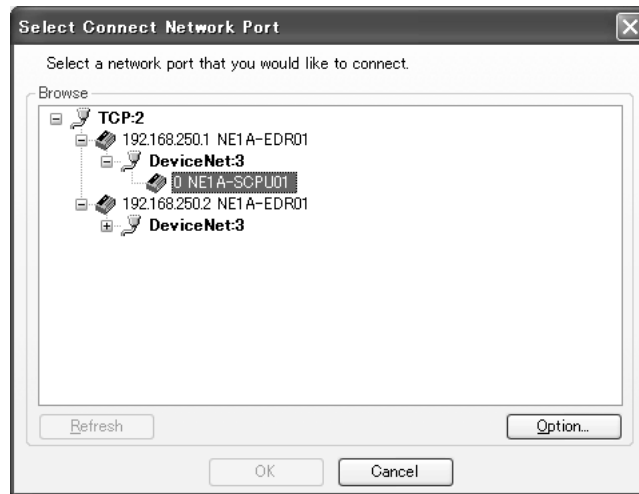

4. Select the network to be connected, and then click the **OK** Button. The Select Connected Network Dialog Box will be displayed.

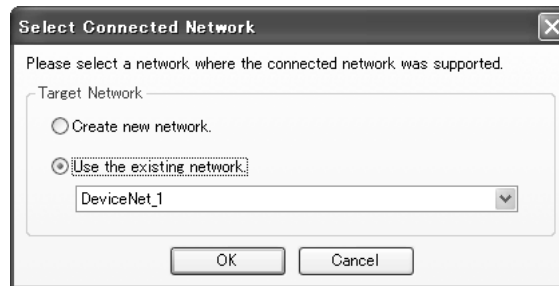

5. Select the network to be connected, and then click the **OK** Button. If an on-line connection is made normally, *On-line* will be displayed in the status bar at the bottom of the window. A tab for the network to be connected will be displayed in blue as in the following figure.



3-4-4 Connecting to a Network

This section describes the basic concept of connecting the Network Configurator to an actual network.

As shown in the following figure, the description will use an example with multiple networks in a system. In the example in the figure, the networks are DeviceNet_1, EtherNet_1, and DeviceNet_2.

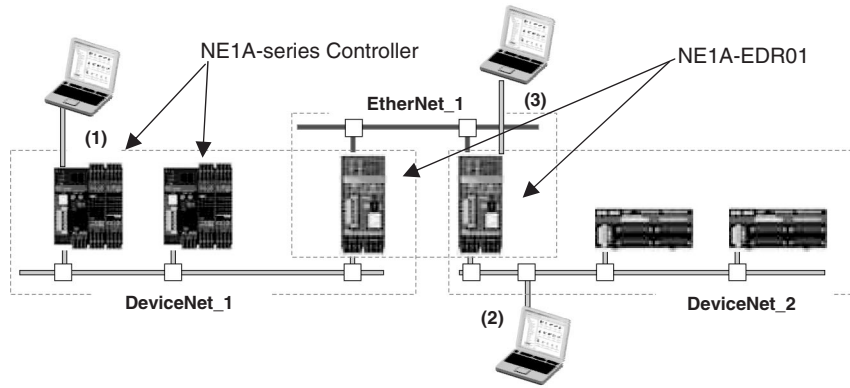

There are three ways to connect the Network Configurator to the network.

- a. Connection via a USB port (connection to an NE1A-series Controller)
- b. Connection via a DeviceNet Interface Card
- c. Connection via Ethernet (NE1A-EDR01: Network Configurator version 2.0 or higher, NE1A-SCPU01-EIP or NE1A-SCPU02-EIP: Network Configurator version 2.2 or higher)

With Network Configurator version 1.6 or earlier, operations (e.g., downloading and uploading) can be performed only for networks that have devices connected. In the figure above, if a connection is made at network 1, only devices on DeviceNet_1 can be accessed, and if connection is made at network 2, only devices on DeviceNet_2 can be accessed.

When using Network Configurator version 2.0 or higher with a network that contains the NE1A-EDR01, CPU Units with unit version 2.0 (see note 1), and CPU Units that support EtherNet/IP (see note 2), uploading, downloading, and other online operations can be performed for networks other than the network to which the connected device belongs. If a connection is made to the NE1A-SCPU01 Controller (pre-version 1.0) in network 1, operations can be performed only for the DeviceNet_1 network.

- Note**
- (1) For CPU Units with unit version 1.0 or earlier, uploading and downloading can be performed only for devices that are connected to the network to which the CPU Unit belongs.
 - (2) CPU Units (with EtherNet/IP) support the Network Configurator of version 2.2 or higher.

When the Network Configurator is connected to the network, a blue icon will be displayed on the tab of a destination network, and a green icon will be displayed on the tab of an operable network, as in the following figure.



The tab may remain grey after a network has been set to online. This indicates that the network is inoperable at the present online destination. The connection destination must be changed to operate the network. Change the connection destination using the procedure described in 3-4-5 Changing a Connection Destination.

3-4-5 Changing a Connected Network

This section describes how to change a connection destination.

Note This function is enabled only when connection is made to the NE1A-EDR01 via Ethernet, connection is made to the NE1A-SCPU02 (unit version 2.0) via USB, or connection is made to the NE1A-SCPU01-EIP or NE1A-SCPU02-EIP via USB or Ethernet.

1. Select **Network - Select Connect Network Port**. The Select Connect Network Port Dialog Box will be displayed.

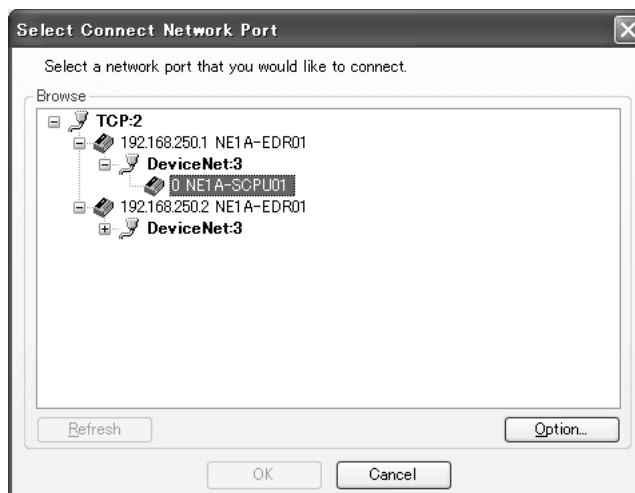

2. Select the network to be connected, and then click the **OK** Button. The Select Connected Network Dialog Box will be displayed.

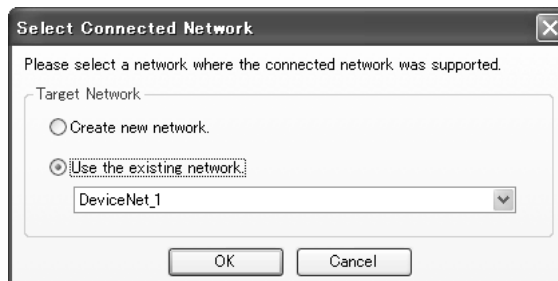

3. Select the network to be connected, and then click the **OK** Button. If an online connection is made normally, *On-line* will be displayed in the status bar at the bottom of the window.

A tab for the network to be connected will be displayed in blue as in the following figure.



Note Until *Select Connect Network Port* is used again to change the connection destination, the network selected in step 3 (displaying a blue icon) and related networks (displaying a green icon) will be operable.

3-5 Creating a Virtual Network

To set device parameters and to program NE1A-series Controllers, create a virtual network in the Network Configurator, set the device parameters in the virtual network, and then download the parameters to the actual devices.

This section describes how to create a virtual network.

3-5-1 Creating a New Virtual Network

When the Network Configurator is started, a new virtual network can be created.

Use one of the following methods to create a new virtual network.

1. Select **File - New** from the menu bar.
2. Click the **New** Button on the toolbar.

Alternatively, select **Network - Add** from the menu bar to add another new virtual network.

Note When a new virtual network is created with unit version 1.6□ or higher, the virtual network information that was displayed until then will be deleted. If the previous virtual network information is required, save the data before creating a new virtual network.

3-5-2 Network Numbers

The DeviceNet Safety System can be used to build multiple networks. Network numbers are used in combination with node addresses to specify unique devices and confirm communicating nodes in this kind of multi-network configuration. This value is called a TUNID (Target Unique Network Identifier) and is stored in the non-volatile memory of each device.

Setting TUNIDs

The TUNID is automatically set when parameters are first downloaded from the Network Configurator to a device in out-of-the-box configuration. (See note.) With Network Configurator version 3.3□ or higher, the Set TUNID command on the Device Menu can be used to specifically set TUNIDs.

Note “Out-of-the-box configuration” indicates the status when a reset-type device is returned to its default status and restarted.

Users do not normally need to be aware of the existence of network numbers because they can visually identify a device on the Network Configurator.

The default network number is automatically generated based on the date and time the Network Configurator created the network configuration, but it can also be specified by the user.

Cases Where the User Needs to Specify Network Numbers

The automatically generated network numbers will be sufficient when the Network Configurator is used to set all the devices on the network. In the following cases, however, the user must set a different network number for each network.

1. When multiple Network Configurators are used to set individual devices: When more than one Network Configurator is used to make settings on the same network, the same network number must be set for each device.

2. When more than one type of setting software is used:
When setting software other than Network Configurator is used because devices made by other manufacturers are being used, specify the same network number with each type of setting software.

Precautions When Downloading to Existing Networks

Parameters cannot be downloaded to devices if the new automatically generated TUNIDs that are sent are different from the TUNIDs that were previously saved in the devices. Observe the following precautions.

Always use one of the four methods listed below when downloading parameters to a device that has already had parameters downloaded to it.

If the download is executed without performing one of these, the download will fail because the transmitted TUNIDs and the TUNIDs in the devices will be different. A “Different TUNID” error message will appear in the error history.

Method 1: Download the parameters using the previously created network configuration file.

Method 2: Download the parameters based on the configuration obtained from a network upload.

Method 3: If using a newly created network configuration file, get the network number from the actual network (a function of Network Configurator version 1.50 or higher; see note). Make the virtual network number in Network Configurator the same as the actual network number and then download the parameters.

Note Use the following procedure to get the network number.

- (a) Select **Network – Property** or right-click the Network Configuration Window and select **Property**. Click the **Get from the actual network** Button in the Network Number Area in the Network Property Dialog Box.
- (b) The network number of the real number that you want to download will be read to the personal computer.
- (c) Click the **OK** Button and update the network number, and then re-execute the download.

Method 4: If using a device that has been used in another location, reset the device to out-of-the-box configuration (see note) and download using methods 1, 2, or 3.

Note Select **Device – Reset** or click the right mouse button and select **Reset** to display the Reset Device Dialog Box. Set the reset type to **Return to the out-of-box configuration, and then emulate cycling power** and click the **OK** Button.

Generally, method 1 should be used, i.e., save the master network configuration file and use it to make any network configuration or parameter changes. Then download parameters using that master file.

When connecting a new device to the network, use method 4 and reset the device to initial status before downloading.

Note When the parameters are downloaded to the devices, the network number is transferred with the parameters as the UNID and saved in the devices. Therefore, when using a device whose parameters have already been downloaded to another domain, set the reset type to *Return to the out-of-box configuration, and then emulate cycling power* and perform a reset to clear the UNID.

Use the following procedure to set the network number.

1. Select **Network - Property** from the menu bar.
2. In the Network Number Field, select the *Manual* Option and enter the value.

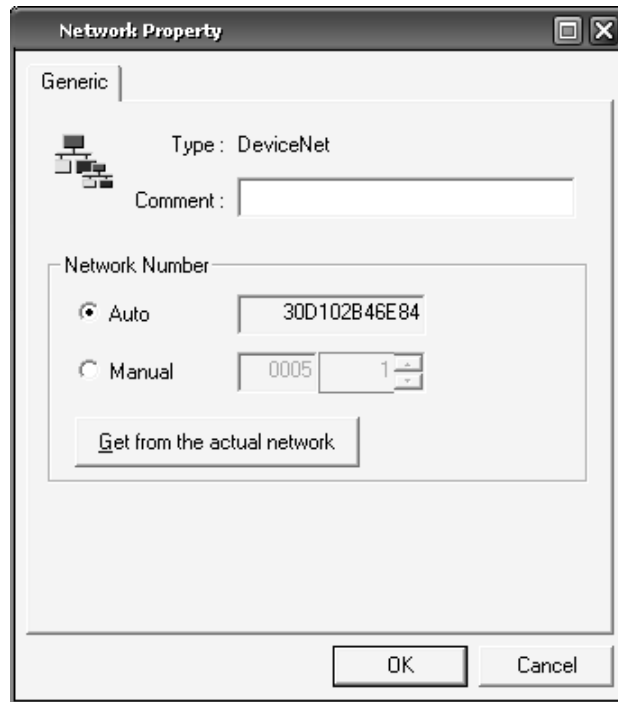

IMPORTANT Always allocate a unique network number when a network or subnetwork is established.

If the network number is not set correctly, a connection may be opened to a different device. A different network number must be set for each network domain, and the same network number must be set for all the devices on the same domain.

If the network number is set by the user, click the **Get from the actual network** Button in the Network Number Field on the Network Property Dialog Box to check the network number set for the target actual network. The network number set to the target network will be read and displayed in the *Manual* Field.

3-5-3 Adding Devices

You can use the following methods to add devices to a virtual network.

1. Add from the Hardware List.
2. Upload the network configuration from the actual network.

Adding Devices from the Hardware List

There are three ways to add a device to the virtual network from the Hardware List.

1. Double-click the selected device in the Hardware List.
2. Select the device from the Hardware List and drag it to the Network Configuration Pane.

When a device has been registered, it will be displayed as follows:

3. Select the target device from the Hardware List, and then select **EDS File – Add to Network** from the menu.

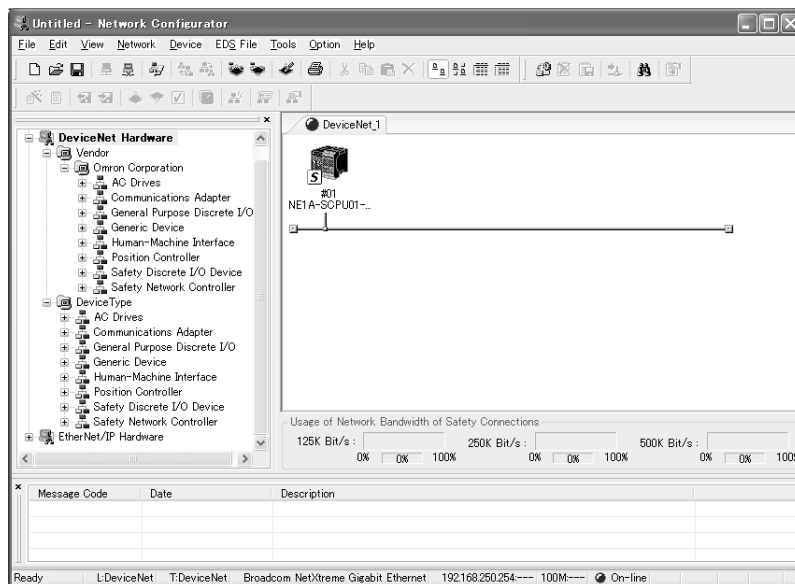

Uploading the Network Configuration from the Actual Network (Network Upload)

The network configuration can be read from the actual network and to create the same configuration in the virtual network. Connect the Network Configurator to the network, and then upload the network configuration using any of the following methods.

1. Select **Network - Upload** from the menu bar.
2. Click **Upload from Network** on the toolbar. Uploading will start, and the detected devices will be displayed sequentially.
3. Right-click without selecting any device in the Network Configuration Pane and select **Upload**.

A dialog box will be displayed to check if the configuration can be uploaded with the current device configuration.

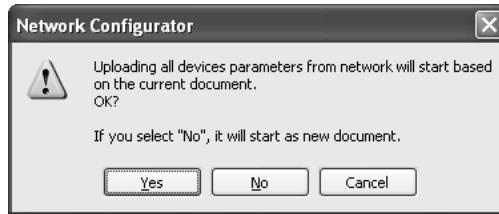

- Click the **Yes** Button to start uploading with the current device configuration.
- Click the **No** Button to delete the current device configuration, and then start uploading.

The following dialog box will be displayed if the currently displayed network is different from the connection destination network.

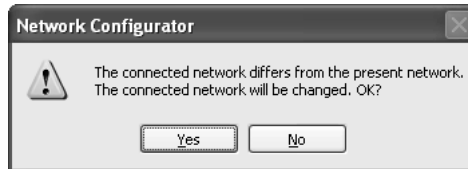

- Uploading will be cancelled if the **No** Button is clicked.
- The following dialog box will be displayed if the **Yes** Button is clicked.

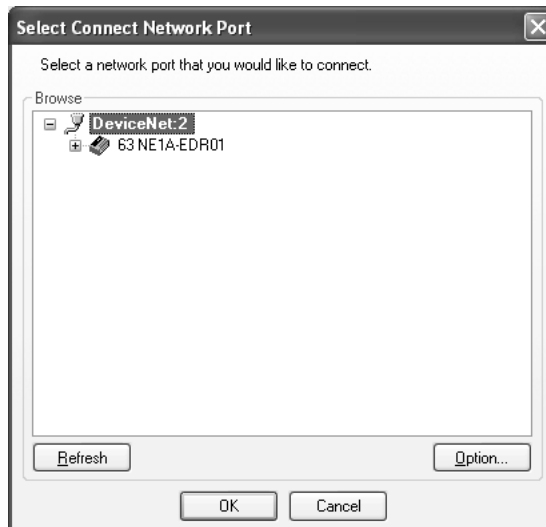

- Select the network port to be connected, and then click the **OK** Button. Uploading will start.

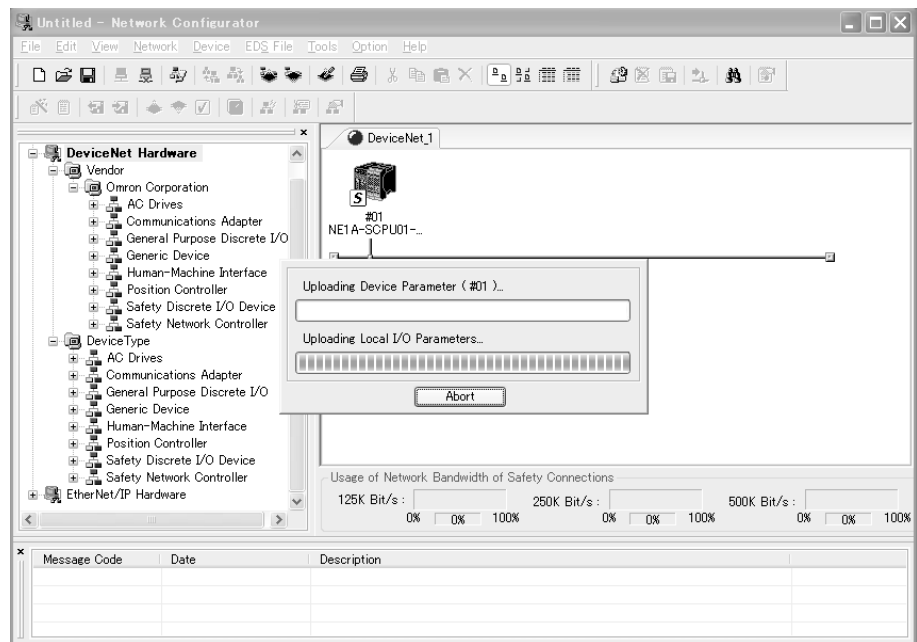

- After uploading has been completed, the following dialog box will be displayed if there is a NE1A-SCPU01-EIP, NE1A-SCPU02-EIP, or NE1A-EDR01 in the network.

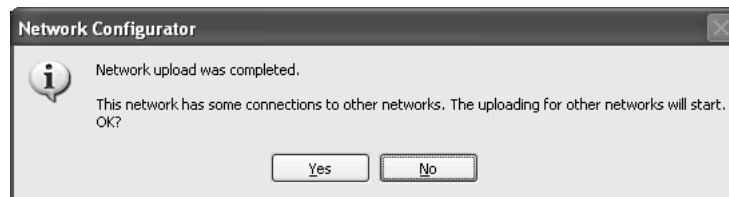

- The following dialog box will be displayed if the **Yes** Button is clicked here.

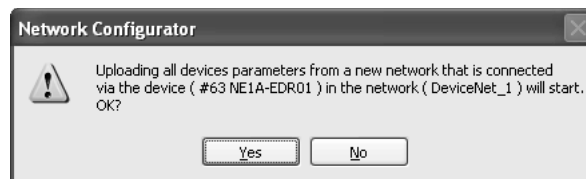

- Uploading for the target network will start if the **Yes** Button is clicked here. If there is another device that must be added after the upload has completed, add the device following the same procedure as in *Adding Devices from the Hardware List*, above.

IMPORTANT If there is a CS/CJ-series DeviceNet Unit in the network, disable the master function of the CS/CJ-series DeviceNet Unit, or disable I/O communications from the DeviceNet Unit monitor window, and then do the upload. If I/O communications are enabled, uploading the device parameters may fail.

- Note**
- When uploading the network configuration from a network, it can be uploaded as the configuration or the current network or as a new network.
 - When data is uploaded as a new network, the virtual network information that was displayed until will be deleted. If the previous virtual network information is required, save the data before the uploading the network.

- When a network in which devices already have a set network number is uploaded, the value that is already set in the devices will be used for the network number.

Reusing Network Configurations

Network configurations can be reused starting from version 2.01. Use the following procedures.

1,2,3...

1. Open the project file from which the configuration information is to be re-used.
2. Select **File - Save As** from the menu bar. The following dialog box will be displayed.

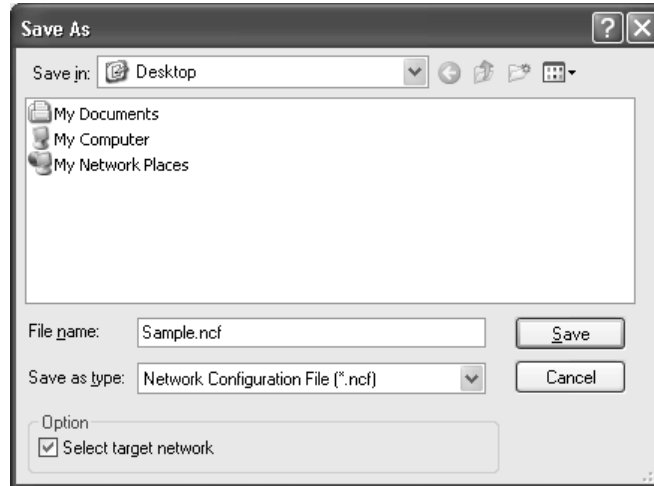

3. A *Select target network* Check Box will be displayed in the *Option* Area. If this check box is not selected, the configuration information for all networks will be saved.
4. Select the check box and click the **Save** Button. The following dialog box will be displayed.

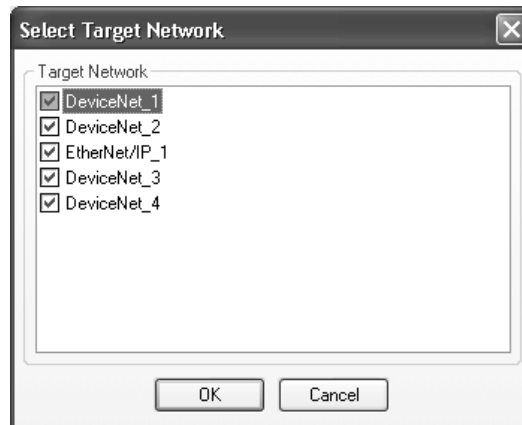

5. Select the networks for which the configuration information is to be saved and click the **OK** Button. The configuration information for the selected networks will be saved in a file.

The configuration information on devices on the selected networks in the virtual networks has now been saved. Use the following procedure to reuse the configuration information in the file.

- 1,2,3... 1. Select **File - Open** from the menu bar. The Open Dialog Box will be displayed. (You can also select project files saved from the previous version of the Network Configurator.)

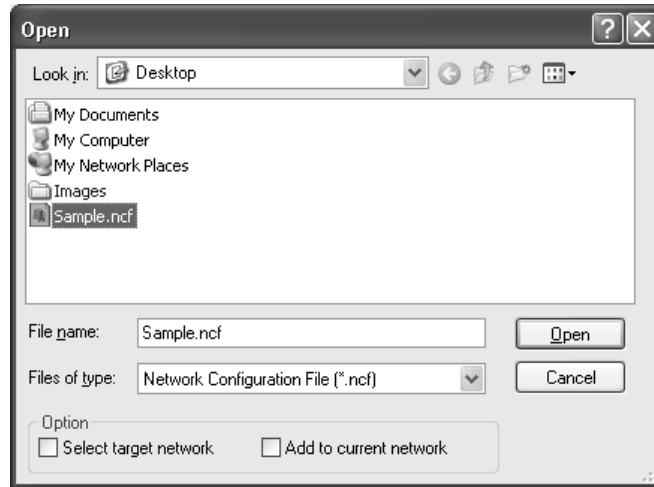

2. Two check boxes will be displayed in the *Option Area*: *Select target network* and *Add to current network*. If neither of these check boxes is selected, a file can be selected using the same procedure as for version 2.0.
3. As an example, select the *Select target network* Check Box and click the **Open** Button. The following dialog box will be displayed.

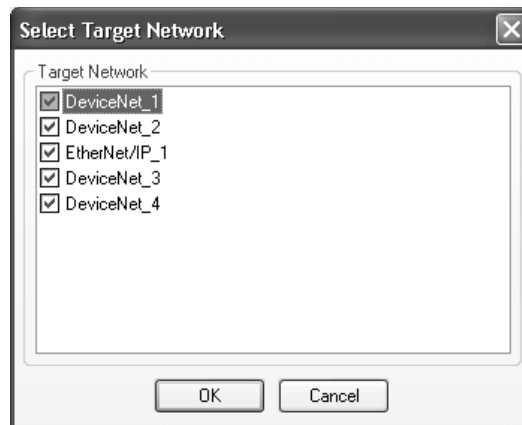

4. The networks with configuration information saved in the file will be displayed. Select the networks for which the configuration information is to be reused and click the **OK** Button. The configuration information for only the selected networks will be read.
5. If the *Add to current network* Check Box is selected in the Open Dialog Box before the **Open** Button is clicked, the configuration information read from the file will be added to the current network.

Note Starting from version 2.01, the network tabs that are displayed can be moved by dragging and dropping them.



3-5-4 Deleting Devices

There are three ways to delete a device from a virtual network.

1. Select a device, and then select **Edit - Delete** from the menu bar.
2. Select a device, and then click the **Delete** Button on the toolbar.
3. Select a device, and then right-click the selected device and select **Delete**.

A confirmation dialog box will be displayed before the deletion. Click the **Yes** Button to delete the device.

3-5-5 Changing the Node Address or IP Address

When a device is added from the Device List, an unused node address or IP address is automatically allocated sequentially in the order the device is added.

There are two ways to change the allocated node address or IP address.

1. Select a device, and select **Device - Change Node Address** from the menu bar.
2. Select a device, and then right-click the device and select **Change Node Address**.

The following dialog box will be displayed. Change the node address or IP address and click the **OK** Button.

■ DeviceNet Device

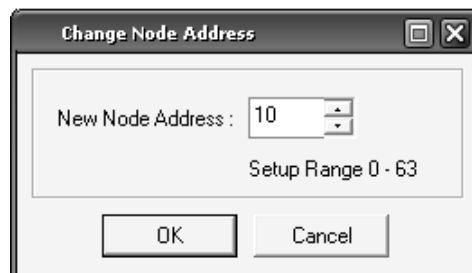

■ EtherNet/IP Device

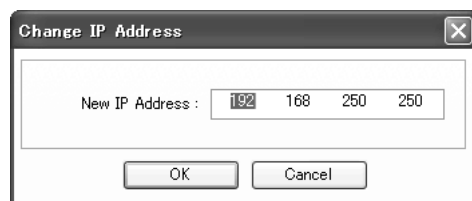

- Note**
- (1) The above method is used to change the node address or IP address of devices on a virtual network.
 - (2) For information on changing the node address or IP address of devices that are online, refer to *A-5-2 Setting the Node Addresses and Baud Rates via the Network* and *A-5-3 Setting TCP/IP Over a Network*.

3-5-6 Changing Device Comments

When a device is added from the Device List, the displayed comment is the device type. Device comments can be set in the following two ways.

1. Select a device, and then select **Device - Change Device Comment** from the menu bar.

2. Select a device, and then right-click the device and select **Change Device Comment**.

The following dialog box will be displayed. Enter the device name and click the **OK** Button.



3-5-7 Creating a Connected Network from a Device

When the NE1A-SCPU01-EIP, NE1A-SCPU02-EIP, or NE1A-EDR01 is registered, either of the following methods can be used to create a new virtual network.

1. Select the device, and then select **Device - Register to Routing Network** from the menu.
2. Right-click the device and select **Register to Routing Network** from the pop-up menu.

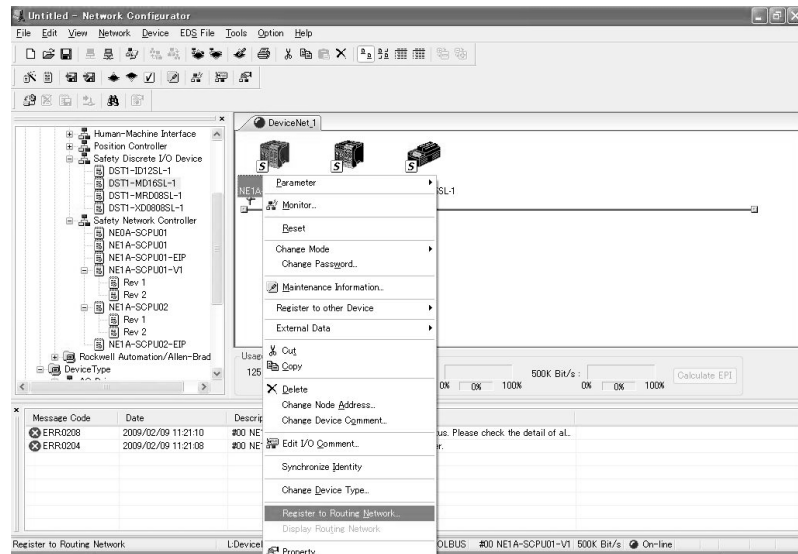

The following dialog box will be displayed.



Click the **Yes** Button.

A new connected network will be created as shown below.

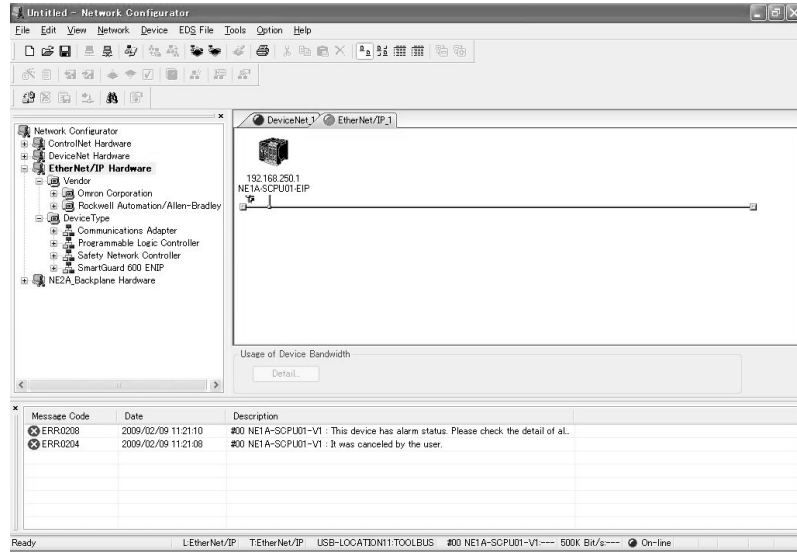

3-6 Saving and Reading Network Configuration Files

The created network configuration of the virtual network can be saved in a file. Also, you can open the saved file, modify it, or download it to the devices by connecting to the network.

3-6-1 Password Protection of the Network Configuration File

A password can be set for the network configuration file. The set password is encrypted and saved in the file. By setting the password for the network configuration file, the file is protected from unintended or unauthorized access.

The network configuration file password must be entered when the following operations are performed in the Network Configurator:

- Saving the network configuration file
- Reading the network configuration file
- Changing the network configuration file password

The passwords must match to save the file. If the password does not match when opening a file, Protect Mode is started. In Protect Mode, some Network Configurator operations are restricted.

The password for the network configuration file is set when the file is saved for the first time. The password must be from 6 to 16 alphanumeric characters. If you do not want to set a password, enter nothing and click the **OK** Button.



To change the password for a network configuration file, select **File - Change Password** from the menu bar. After changing the password, however, the file and the password must be saved.

IMPORTANT

- For security purposes, it is recommended to set a password for network for network configuration files.
- Do not forget the set password. You can open a network configuration file only in read-only mode if the password is forgotten, i.e., the file cannot be edited.

3-6-2 Saving the Network Configuration File

The network configuration can be saved using either of the following methods.

1. Select **File - Save** or **File - Save As** from the menu bar.
2. Click the **Save** Button on the toolbar.

Either way, the dialog box for saving will be displayed. Select the saving location, name the file, and then click the **Save** Button.

When saving the file for the first time, the Assign Password Dialog Box will be displayed. Enter the password to set for the network configuration file.

When saving the second time or after, the Password Confirmation Dialog Box will be displayed. Enter the password set when the network configuration file was initially saved.

When saving has completed successfully, the following message will be displayed in the Message Pane:

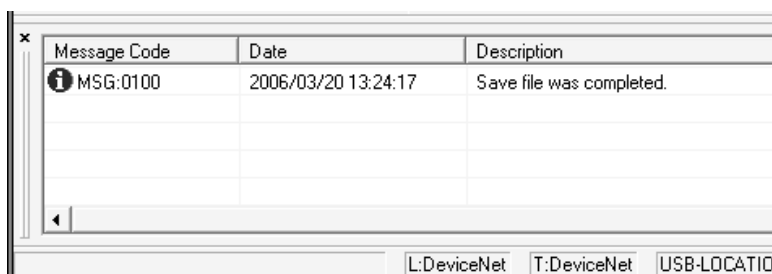

There are two file formats: Network Configurator v2 files (ncf) for version 2.2□ or lower and Network Configurator v3 files (nfv) for version 3.3□ or higher.

To save to the v2 format from version 3.3□ or higher, select **Save As** and then select *Network Configurator v2 file* before saving the file.

3-6-3 Reading a Network Configuration File

The saved network configuration file can be read for use by the Network Configurator using either of the following methods.

1. Select **File - Open** from the menu bar.
2. Click the **Open** Button on the toolbar.

For either method, the Open File Dialog Box will be displayed. Select the file to open, and click the **Open** Button.

Next, the Check Password Dialog Box will be displayed. Enter the password set when the network configuration file was saved.

When reading has completed successfully, the following message will be displayed in the Message Pane:

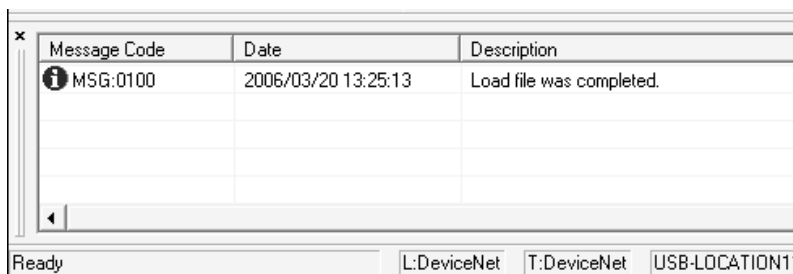

To read a v1/v2 format from version 3.3□ or higher, select *Network Configurator v1/v2 file (ncf)* as the file type in the Open File Dialog Box.

IMPORTANT If there is a device in the Network Configurator version 1 or version 2 network configuration file (extension .ncf) for which the EDS file is not installed, the Network Configurator will not be able to read the file normally. Install the EDS files for all of the relevant devices in advance.

Note If the password does not match, the Network Configurator will open the file in Protect Mode. In Protect Mode, operations such as saving the file and changing device status are prohibited. Refer to 3-6-4 *Protect Mode* for details.

3-6-4 Protect Mode

If the password does not match when opening the network configuration file, the Network Configurator will open the file in Protect Mode.

If the password does not match, the following message will be displayed in a dialog box and the Message Pane.



The following table shows the functions that cannot be manipulated in Protect Mode.

Function		Version 2.1 or lower	Version 2.2 or higher	
Menu	Submenu/Command			
File	Save	Operation not supported	Operation not supported	
	Save as	Operation not supported	Operation not supported	
	Change password	Operation not supported	Operation not supported	
Network	Download	Operation not supported	Operation supported (Downloading is possible if the network configuration file has not been edited.)	
Device	Parameter	Save	Operation not supported	
		Download	Operation supported (Downloading is possible if the network configuration file has not been edited.)	
		Lock/Unlock	Operation supported	
	Change password		Operation not supported	Operation not supported
	Reset		Operation not supported	Operation supported
	Change mode		Operation not supported	Operation supported
Tool	General parameter settings	Operation not supported	Operation not supported	
	Node address/baud rate settings	Operation not supported	Operation not supported	
	TCP/IP settings	Operation not supported	Operation not supported	

3-7 Device Password Protection

A safety device can save a password internally. Setting the password in the device prevents an unauthorized person from changing the safety device parameters and status.

3-7-1 Setting a Device Password

Entering a device password is required when the following operations are performed on the Network Configurator. If the password does not match, the operations cannot be performed.

Menu	Submenu/Command	
Network	Download	
Device	Parameter	Download
		Lock/Unlock
	Change password	
	Reset	
Change mode		

A password is set for each device using either of the following methods. This function can be used only when the Network Configurator is online.

1. Select a device, and then select **Device - Change Password** from the menu bar.
2. Select a device, and then right-click the device and select **Change Password**.

The Change Password Dialog Box will be displayed as shown in the following figure. Enter the current password and a new password, and click the **OK** Button.

A password can contain from 6 to 16 alphanumeric characters.



Device passwords are not stored in the Network Configuration File. There is no password in the default settings. If the device is reset by setting the *Reset Type* to *Return to the out-of-box configuration*, and then emulate cycling power, it will return to the no-password setting. To reset the device, however, entering the current password is required. Therefore, do not forget the device password.

IMPORTANT For security purposes, it is recommended to set passwords for devices.

Note If you set the same password for multiple devices and perform an operation that requires entering a password, entering the password once can be treated as entering the password for all the devices. Select the *Use this password for all device* check box in the Password Input Dialog Box.



3-7-2 Forgotten Device Passwords

If you forget a device password, contact your OMRON Support Center. If you enter the recovery key obtained from the Support Center in the Password Recovery Tool installed in the Network Configurator, you can return the device to the no-password setting.

To obtain the recovery key, the following information is required. Use the Password Recovery Tool to obtain the information from the device. For details, refer to *A-6 Using the Password Recovery Tool*.

- Vendor ID
- Serial number
- Counter information

3-8 Device Parameters and Properties

Registered device parameters can be edited on the virtual network without restrictions. Also, for parameters saved as a network configuration file, you can open the file later and download to a device or make modifications.

3-8-1 Editing Device Parameters

Device parameters can be edited using any of the following methods.

1. Double-click a device icon.
2. Select a device, and then select **Device - Parameter - Edit** from the menu bar.
3. Select a device, and then click the **Edit Parameter** Button on the toolbar.
4. Select a device, and then right-click the device and select **Parameter - Edit**.

The edit window for device parameters varies depending on the device.

Refer to *SECTION 5 Editing Safety Network Controller Parameters*.

IMPORTANT Editing cannot be performed in the EtherNet/IP Window with the NE1A-SCPU01-EIP or NE1A-SCPU02-EIP. Perform editing in the DeviceNet Network Window.

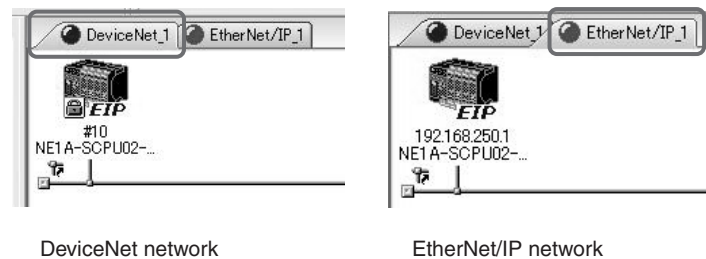

DeviceNet network

EtherNet/IP network

Refer to *A-7 Restrictions in Support Software Operations for the CPU Unit with EtherNet/IP* for information on functions that cannot be manipulated in the EtherNet/IP Network Window.

3-8-2 Uploading Device Parameters

Parameters of all the devices in the network that is currently displayed in the Network Configuration Window can be uploaded from the network. Any of the following methods enables uploading parameters from one or more selected devices. This function is enabled only when the Network Configurator is online.

1. Select one or more devices, and then select **Device - Parameter - Upload** from the menu bar.
2. Select one or more devices, and then click the **Upload from Device** Button on the toolbar.
3. Select one or more devices, and then, right-click each device and select **Parameter - Upload**.

Whichever method is used, perform the operation according to the following procedure.

This operation is supported for devices in a network that has a tab icon displayed in blue or green when the Network Configurator is connected to the network (except when a USB connection is made to an NE1A-series Controller).

IMPORTANT If there is a CS/CJ-series DeviceNet Unit in the network, disable the master function of the CS/CJ-series DeviceNet Unit, or disable I/O communications from the DeviceNet Unit monitor window, and then do the upload. If I/O communications are enabled, uploading the device parameters may fail.

Note To upload the network configuration, refer to *Uploading the Network Configuration from the Actual Network (Network Upload)* in 3-5-3 Adding Devices.

The following dialog box will be displayed when the above operation is performed.

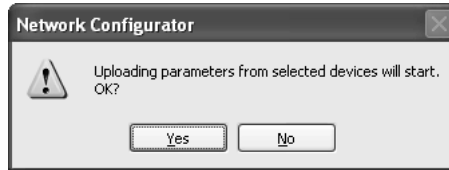

- Click the **Yes** Button to start uploading.
- Click the **No** Button to cancel uploading.

The following dialog box will be displayed when the parameters have been uploaded.



IMPORTANT Uploading cannot be performed in the EtherNet/IP Network Window for the NE1A-SCPU01-EIP and NE1A-SCPU02-EIP. Perform uploading in the DeviceNet Network Window.



DeviceNet network

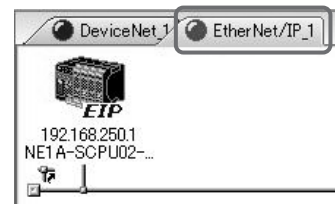

EtherNet/IP network

Refer to *A-7 Restrictions in Support Software Operations for the CPU Unit with EtherNet/IP* for information on functions that cannot be manipulated in the EtherNet/IP Network Window.

3-8-3 Downloading Device Parameters

There are two ways to download parameters to a device: downloading to the selected devices and downloading sequentially to all the devices in the network. Either way is acceptable. Make sure, however, to download parameters to all the devices.

This function is enabled only when the Network Configurator is online. Downloading parameters also requires entering the device passwords.

Downloading Parameters to a Selected Device

You can download parameters to selected devices using any of the following methods.

1. Select one or more devices, and then select **Device - Parameter - Download** from the menu bar.
2. Select a device, and then click the **Download to Device** Button on the toolbar.
3. Select one or more devices, and then right-click each device and select **Parameter - Download**.

This operation is supported for devices in networks that have a tab icon displayed in blue or green when the Network Configurator is connected to the network (except when a USB connection is made to an NE1A-series Controller).

First, the password input window for the device will be displayed. Enter the password for the selected devices and click the **OK** Button.

When selecting multiple devices and setting the same device password for all the devices, select the *Use this password for all device* check box in the following dialog box, and then entering passwords will no longer be necessary for each device.



IMPORTANT Downloading cannot be performed in the EtherNet/IP Network Window for the NE1A-SCPU01-EIP or NE1A-SCPU02-EIP. Perform downloading in the DeviceNet Network Window.

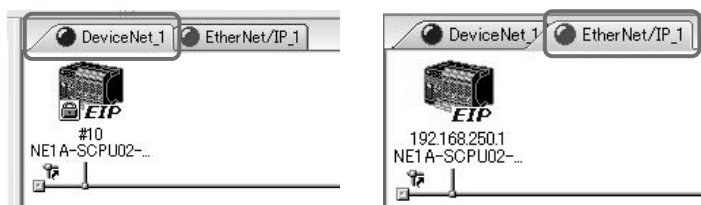

DeviceNet network

EtherNet/IP network

Refer to *A-7 Restrictions in Support Software Operations for the CPU Unit with EtherNet/IP* for information on functions that cannot be manipulated in the EtherNet/IP Network Window.

Downloading Parameters to All Devices in the Network (Network Download)

You can download parameters to all the devices in the network that is currently displayed in the Network Configuration Window by using the following procedure.

Downloading can be performed at the same time for those networks (except when a USB connection is made to an NE1A-series Controller).

1. Select **Network - Download** from the menu bar.
2. Click the **Download to Network** Button on the toolbar.

- In the Network Configuration Pane, right-click without selecting any device and select **Download**.

First, the system will check whether the network configuration held by the Network Configurator and the actual network configuration match. The device type, device name, and network number will be checked. The following dialog box will be displayed if the configurations do not match.

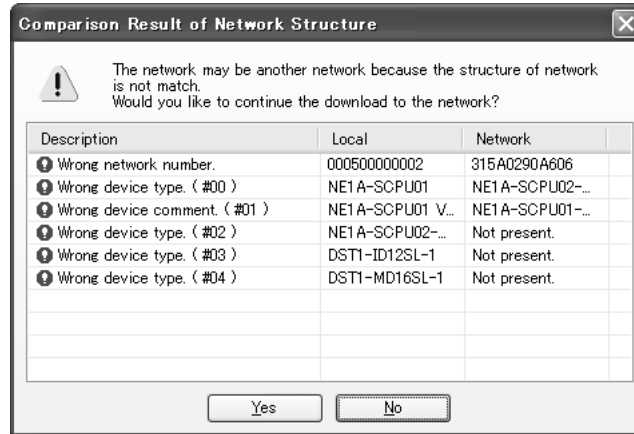

- Click the **No** Button to cancel the process.
- Click the **Yes** Button to start downloading to the network.

The password input window of the devices will be displayed. As described in *Downloading Parameters to a Selected Device*, enter the password for the selected devices and then click the **OK** Button.

Downloading will start.

After downloading has been completed for one network, the following dialog box will be displayed if there are related networks.

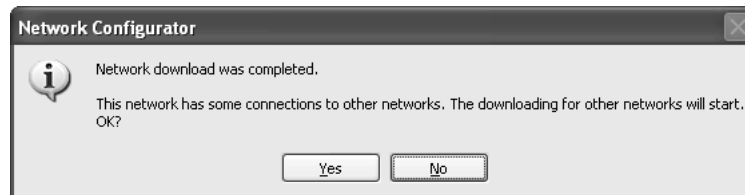

- Click the **Yes** Button here to start downloading for those networks.
- Downloading can be performed at the same time for related networks by repeating this procedure.

Errors while Downloading

When an error occurs while downloading to multiple devices sequentially, the following dialog box will be displayed.

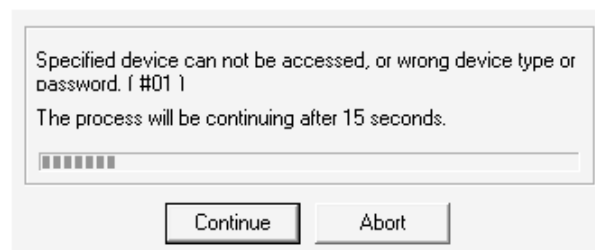

Downloading will continue to the next device if 15 seconds passes and neither button is clicked. If you want to perform the next download immediately, however, click the **Continue** Button.

If you click the **Abort** Button, the download process will be cancelled (and consequently, the parameters will not be downloaded to the subsequent devices).

The error that occurred will be displayed in the Message Pane and the device in which the error occurred will be displayed in the Error Device List.

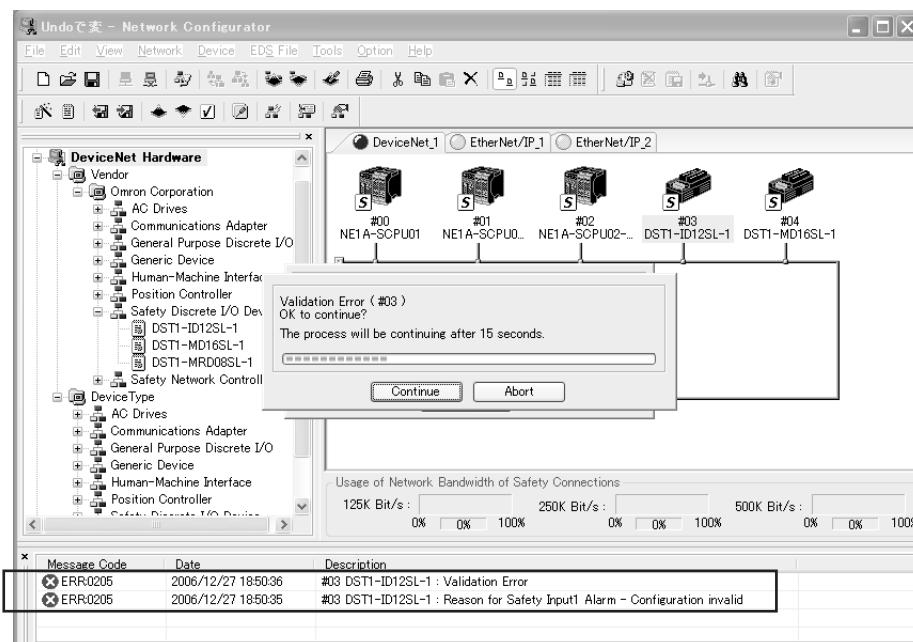

The Error Device List displays by device the errors that occurred during parameter download.

- If the Error Device List shows that a parameter error has been found and if that error was caused by the I/O Terminal settings, the terminal with the error will be displayed in the Message Pane. (Refer to the outlined section in the above diagram.) No alarm will appear in the Error Device List if the error is not caused by the I/O Terminal settings and the cause must be found elsewhere.
- If the Error Device List displays an error stating that the TUNID does not match, click the **Get from the actual network** Button in the Network Number Field on the Network Property Dialog Box (see note). The network number for the actual network to be downloaded will be in the project file data. Click the **OK** Button to update the network number. Then execute the download again. Refer to 3-5-2 Network Numbers for details on network numbers and TUNID.

Note Select **Network – Property** or right-click in the Network Configuration Window and select **Property** to display the Network Property Dialog Box.

Note Refer to 8-2 Errors When Downloading for Error Device List errors other than those listed above, error details, and countermeasures.

Note The download may take time if the NE1A-series Safety Master is in RUN mode. The time required for downloads can be reduced by changing to IDLE mode.

3-8-4 Device Properties

The device information, types of safety I/O and standard I/O, and safety signatures can be checked in the Device Property Dialog Box.

The Device Property Dialog Box can be displayed using any of the following methods.

1. Select a device, and then select **Device - Property** from the menu bar.
2. Select a device, and then click the **Device Property** Button on the toolbar.
3. Select a device, and then right-click the device and select **Property**.

DeviceNet Network Display Windows

General Tab Page

In this tab page, you can check the device information and change the device icon displayed in the Network Configuration Pane.

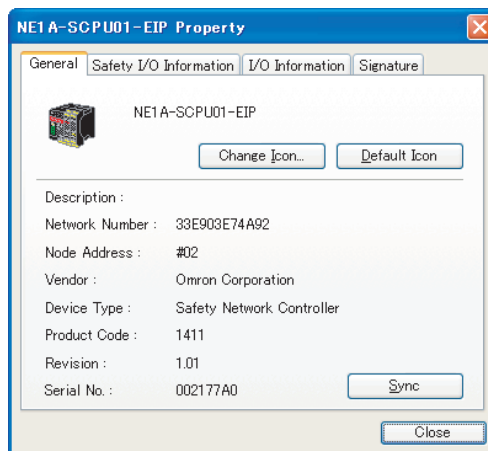

Safety I/O Information Tab Page

In this tab page, you can check the safety I/O classification information of a device.

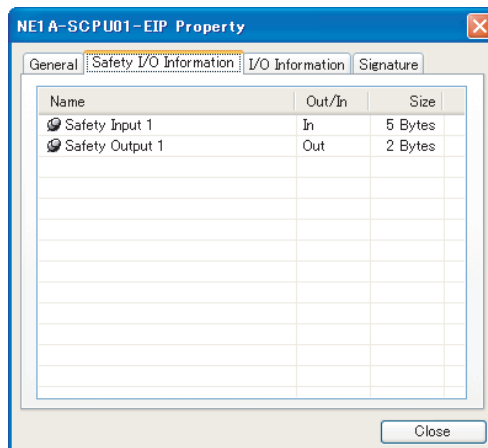

I/O Information Tab Page

In this tab page, you can check the standard I/O classification information of a device.

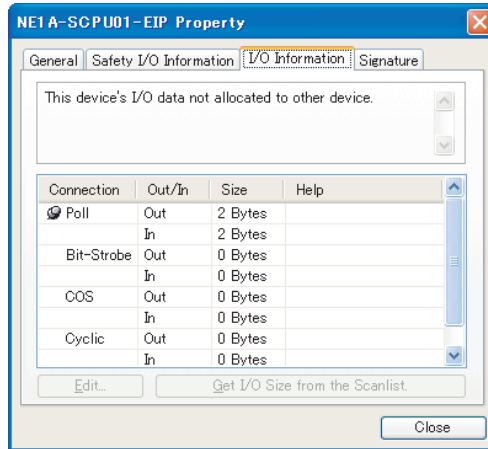

Signature Tab Page

In this tab page, you can check the safety signature that the Network Configurator generated and the one that the actual device has.

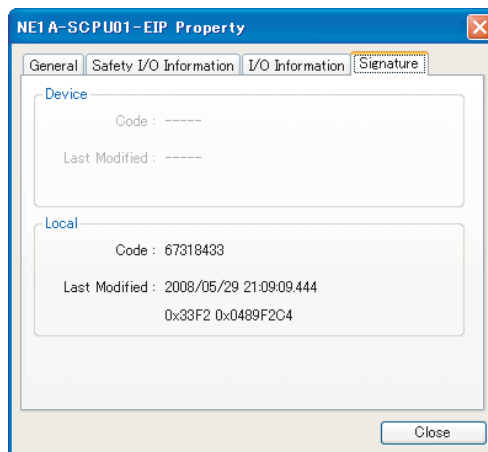

EtherNet/IP Network Display Windows (EtherNet/IP-compatible Units Only)

General Tab Page

In this tab page, you can check the device information and change the device icon displayed in the Network Configuration Pane.



I/O Information Tab Page

In this tab page, you can check the EtherNet/IP standard I/O types for devices.

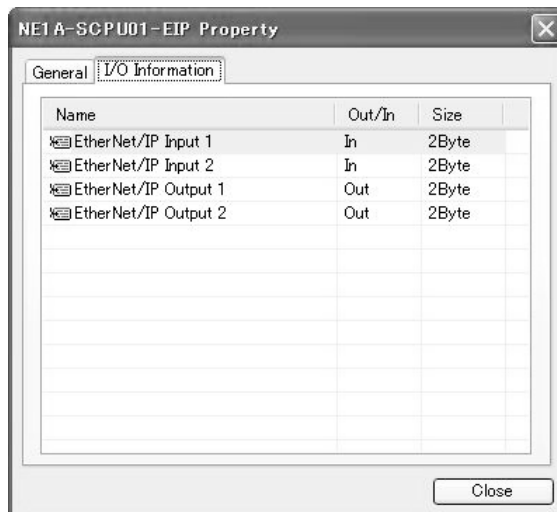

3-9 Parameter Verification

After downloading the parameters to a device, the user must perform parameter verification to check whether the parameters entered by the user were correctly downloaded to the device. The user must perform this verification for safety devices.

3-9-1 Device Parameter Verification

Verify the parameters using any of the following methods after downloading the parameters to devices. This function is enabled only when the Network Configurator is online.

With Network Configurator Ver. 2.0□ or higher, multiple devices can be selected and verified all at once.

1. Select a device, and then select **Device - Parameter - Verify** from the menu bar.
2. Select a device, and then click the **Verify Parameter** Button on the toolbar.
3. Select a device, and then right-click the device and select **Parameter - Verify**.

The device parameters will be uploaded.

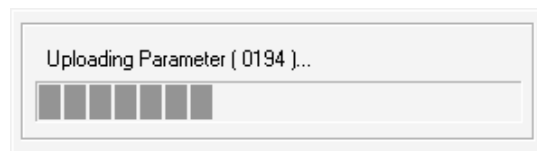

First, the Network Configurator itself checks if the uploaded parameters are different from the parameters in the virtual network. If there are no differences, the following dialog box will be displayed.

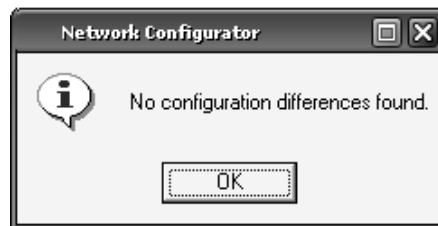

If you click the **OK** Button, the uploaded parameters will be displayed.

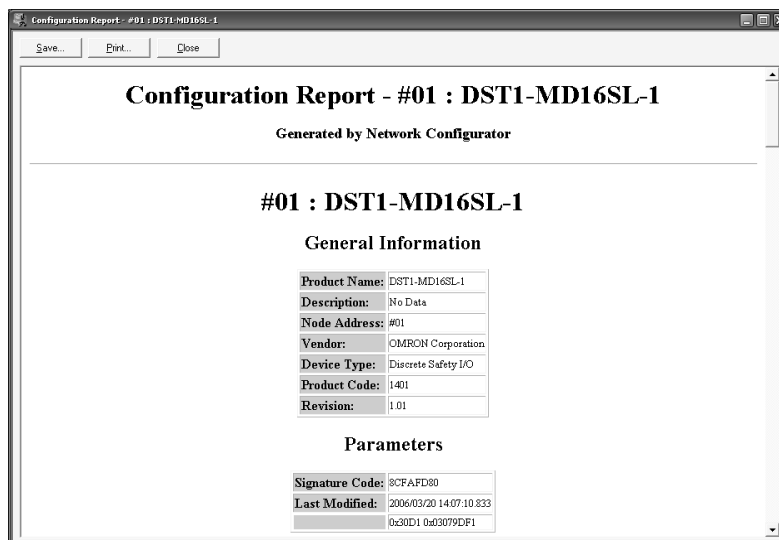

The user must check whether all the displayed parameters match the input values. If the device is the NE1A-series Controller, the Logic Program will also be displayed as in the following window. Check whether the Logic Program matches.

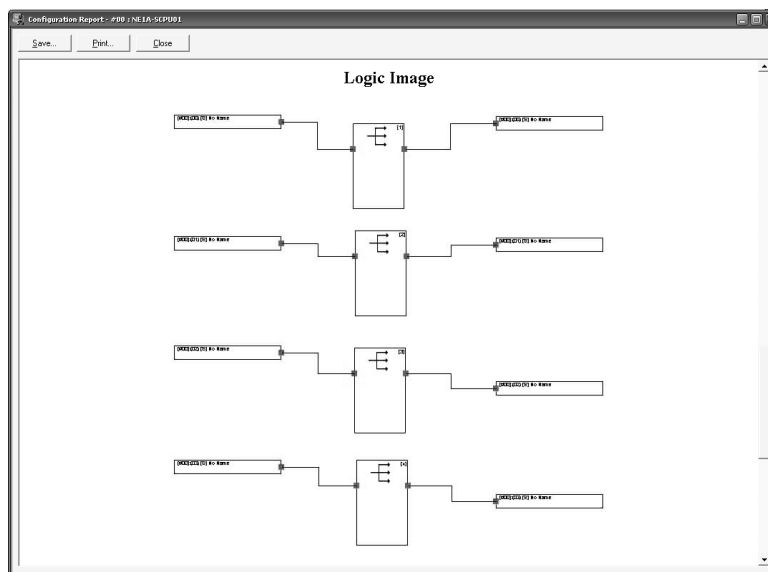

- Note**
- Verification results can be saved. Click the **Save** Button at the top left of the window to save the results.
 - The displayed parameters and logic can also be printed. To print, click the **Print** Button.
 - In some cases the printout may exceed the specified size. Save the file and edit it using HTML editing software, then print the file.

After completing the verification, click the **Close** Button in the upper left to close the window.

The following window will be displayed.



If the parameters match, click the **Yes** Button.

After the verification has been completed, the safety symbol attached to the device icon in the virtual network will turn green, which indicates that verification is done.

With Configurator Ver. 2.0 or higher, the following dialog box will be displayed after the verification has been completed.



Click the **Yes** Button to automatically lock the device.

IMPORTANT After downloading the configuration data, verify the parameters and check whether the parameters saved in the device and the safety signature are correct.

Note Click the **Save** Button to save the configuration parameter report in HTML format. Click the **Print** Button to print the report.

- Note**
- After verifying the parameters of all the devices, make sure to save the network configuration file.
 - The *Verified configuration parameter* symbol ensures that the device parameters in the network configuration file are correct. This information is saved in the network configuration file, but not in the device itself. Therefore, the *Verified configuration parameter* symbol will not be attached even though the network configuration is obtained by network upload from a device that has been already verified.
 - If you edit parameters that have been verified, the *Verified configuration parameter* symbol will disappear. The device parameters must be verified again.

Parameter Mismatch

When the Network Configurator detects a mismatch in parameter verification, the parameter with the mismatch will be displayed with the safety signature in the window as in the following example.

Check the parameter values and perform the download again.

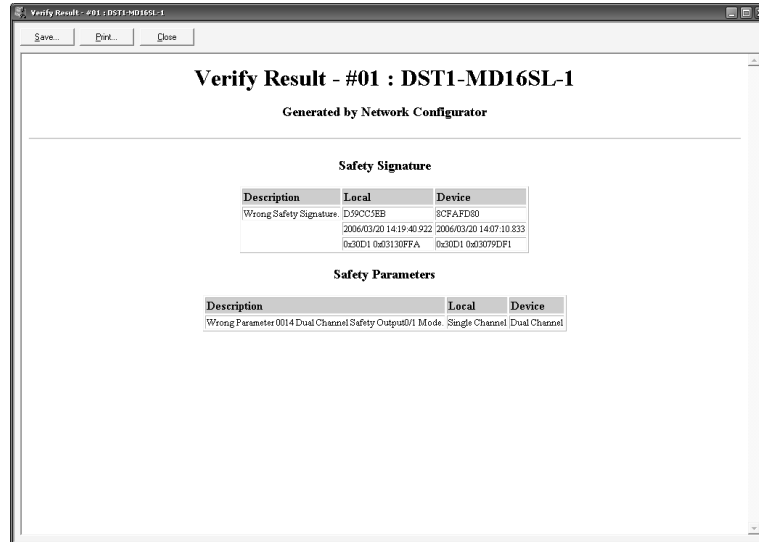

IMPORTANT Verification cannot be performed in the EtherNet/IP Network Window for the NE1A-SCPU01-EIP or NE1A-SCPU02-EIP. Perform verification in the DeviceNet Network Window.

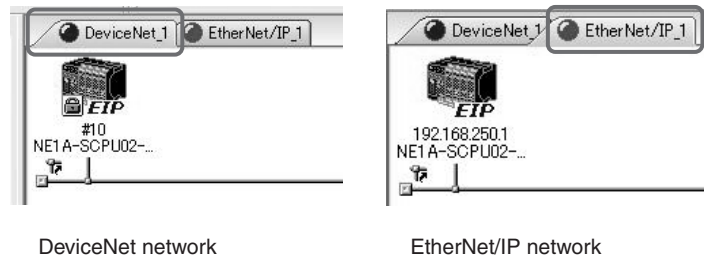

Refer to *A-7 Restrictions in Support Software Operations for the CPU Unit with EtherNet/IP* for information on functions that cannot be manipulated in the EtherNet/IP Network Window.

3-10 Configuration Lock

Perform user testing after verifying the device parameters. Checking all the operations of the device using user testing indicates that the device parameters have been verified by the user.

The configuration lock symbol indicates that the user test has completed.

3-10-1 Locking the Device Configuration

After the user testing, lock the configuration using either of the following methods. This function is enabled only when the Network Configurator is online. Also, to lock the configuration, verification of the device must have been completed already.

1. Select one or more devices, and then select **Device - Parameter - Lock** from the menu bar.
2. Select one or more devices, and then click each device and select **Parameter - Lock**.

Next, the password input window for the device will be displayed. Enter the password of the selected devices and click the **OK** Button.

When selecting multiple devices and setting the same device password for all the devices, select the *Use this password for all device* check box in the following dialog box, and then entering passwords will no longer be necessary for each device.



After the configuration lock has completed, the safety symbol attached to the device icon in the virtual network will change to a symbol of a lock, which indicates that the configuration lock has completed.



IMPORTANT Operation of the device must be tested before lock the configuration.

- Note**
- After performing a configuration lock for all the devices, make sure to save the network configuration file.
 - The symbol that indicates that the configuration lock has been done ensures that the device has been tested. This information is saved in the device itself as well as in the network configuration file.
 - Once the configuration lock has been performed, you cannot download the parameters to the device. To change the parameters, release the configuration lock.

- When verified device parameters are edited, the *Verified configuration parameter* symbol will disappear. The device parameters must be verified again.

3-10-2 Unlocking the Device Configuration

The configuration must be unlocked to change device parameters for which a configuration lock has been performed. Unlock the configuration for the selected devices using any of the following methods. This function is enabled only when the Network Configurator is online.

1. Select one or more devices, and then select **Device - Parameter - Unlock** from the menu bar.
2. Select one or more devices, and then right-click each device and select **Parameter - Unlock**.

Next, the password input window for the device will be displayed. As in *3-10-1 Locking the Device Configuration*, enter the password for the selected devices and click the **OK** Button.

When the configuration has been unlocked, the safety symbol attached to the device icon in the virtual network will return to the *Verified configuration parameter* symbol.

Note When changing the device parameters after a configuration unlock, lock the configuration after verifying the parameters again.

IMPORTANT Locking and unlocking cannot be performed in the EtherNet/IP Network Window for the NE1A-SCPU01-EIP or NE1A-SCPU02-EIP. Perform locking and unlocking in the DeviceNet Network Window.

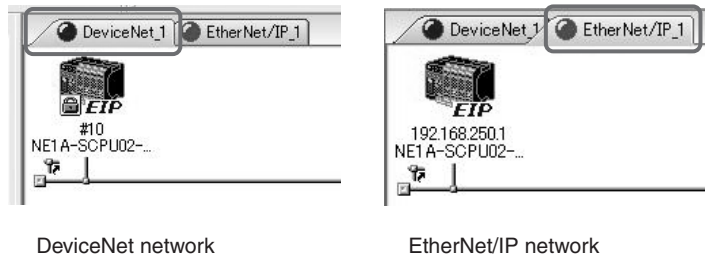

Refer to *A-7 Restrictions in Support Software Operations for the CPU Unit with EtherNet/IP* for information on functions that cannot be manipulated in the EtherNet/IP Network Window

3-11 Device Reset and Status Change

This section describes how to reset and change the status of safety devices. For some device types, status changes may not be supported.

3-11-1 Reset Types

There are three ways to reset a safety device.

Reset type	Description
Emulate cycling power.	Resets in the same way as cycling the power.
Return to the out-of-box configuration, and then emulate cycling power.	Returns the information stored in the device nonvolatile memory to the default settings and restarts.
Return information except for specified parameters to the out-of-box configuration, and then emulate cycling power.	Returns all information stored in the device nonvolatile memory other than specified data to the default settings, and then restarts.

The safety device stores the following information in the nonvolatile memory of the device:

Type	Default setting	Setting timing	Description
Device parameter	Not configured	Parameter download	Parameters and programs set by the user
Node address (software setting)	63	Node address change	Node address at startup with software setting enabled
	Starting in mode acquired from BOOTP server	TCP/IP settings	IP address setting mode at startup (for EtherNet/IP-compatible Units only)
Baud rate (software setting)	125 Kbit/s	Baud rate change	Baud rate at startup with software setting enabled (NE1A Series only)
TUNID (Target Unique Network Identifier)	Not set	First parameter download	The identifier of the local node in the Safety Network as well as the combined values of the network number and node address
Password	No password	Password change	Password that a device has
CFUNID (Configuration Owning UNID)	Not set	First parameter download	UNID of the configuration source
OCPUNID (Output Connection Point Owning UNID)	Not set	Start of first safety communications	UNID of the Safety Master that opens a safety output connection.

The information above is stored in the nonvolatile memory of the device, and so it is not cleared by cycling the power source once it is set. To clear the information (to return to the default settings), select *Return to the out-of-box configuration, and then emulate cycling power* or *Return to the out-of-box configuration except to preserve the following parameters, and then emulate cycling power*.

 **WARNING**

Failure to clear the previous configuration data before connecting the device to the network may result in loss of safety functions, personal injury, or death.



3-11-2 Resetting Devices

Reset devices using either of the following methods. This function is enabled only when the Network Configurator is online.

1. Select one or more devices, and then select **Device - Reset** from the menu bar.
2. Select one or more devices, and then right-click each device and select **Reset**.

The reset window of the devices will be displayed as shown in the following example. Enter a reset type and the password and then click the **OK** Button.

For example, to keep the current password setting for multiples devices with the same password but return other information to the default, specify the setting as follows:

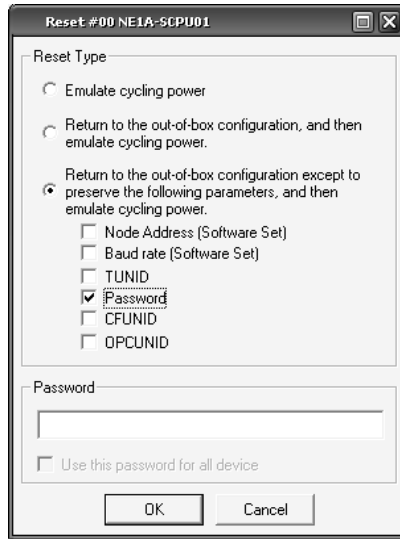

IMPORTANT With NE1A-SCPU01-EIP and NE1A-SCPU02-EIP, resetting to the defaults will clear the IP address settings and the mode will be switched to the mode acquired from the BOOTP server. To not clear the IP address, select the Node Address (Software Set) Check Box to perform a reset so that the IP address will not change.

IMPORTANT Resetting cannot be performed in the EtherNet/IP Network Window for the NE1A-SCPU01-EIP or NE1A-SCPU02-EIP. Perform resetting in the DeviceNet Network Window.

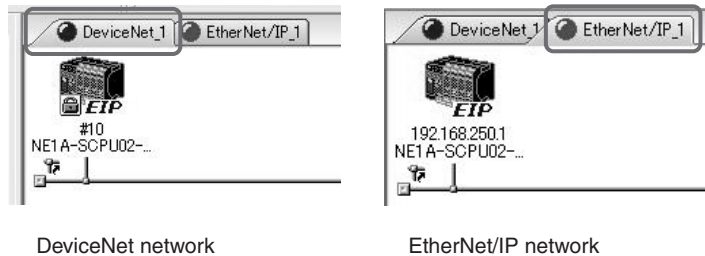

Refer to *A-7 Restrictions in Support Software Operations for the CPU Unit with EtherNet/IP* for information on functions that cannot be manipulated in the EtherNet/IP Network Window.

3-11-3 Reset Types and Device Status

Resetting may not be supported for some types of reset and device status.

Reset type	Device status			
	Safety connection being established and configuration locked.	Safety connection being established and configuration locked.	Safety connection not established and configuration locked.	Safety connection not established and configuration locked.
Emulate cycling power	Unable to reset.	Unable to reset.	Able to reset.	Able to reset.
Return to the out-of-box configuration, and then emulate cycling power.	Unable to reset.	Unable to reset.	Unable to reset.	Able to reset.
Return information except for specified parameters to the out-of-box configuration, and then emulate cycling power.	Unable to reset.	Unable to reset.	Unable to reset.	Able to reset.

3-11-4 Changing Device Status

Changing the device status is not supported by all devices.

The NE1A-series Controller can switch between IDLE mode and RUN mode. For details on NE1A-series Controller modes, refer to the *Safety Network Controller Operation Manual (Z906)*.

For DST1-series Safety I/O Terminals, there is no need to change modes.

Change the device mode using either of the following methods. This function is enabled only when the Network Configurator is online.

With Network Configurator Ver. 2.0□ or higher, modes can be changed all at once by selecting multiple devices.

1. Select a device, and then select **Device - Change Mode** followed by the desired mode.
2. Select a device, and then right-click the device and select **Change Mode** followed by the desired mode.

Next, the password input window for the device will be displayed. Enter the password for the selected devices and click the **OK** Button.



IMPORTANT The mode cannot be changed in the EtherNet/IP Network Window for the NE1A-SCPU01-EIP or NE1A-SCPU02-EIP. Change the mode in the DeviceNet Network Window.

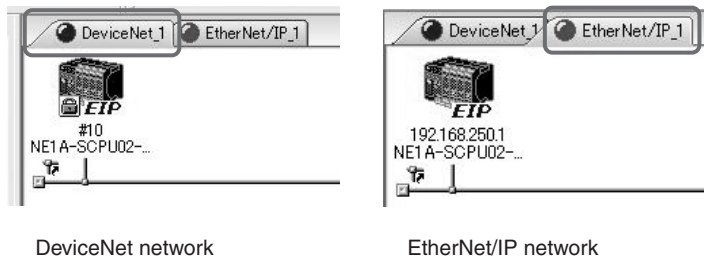

Refer to *A-7 Restrictions in Support Software Operations for the CPU Unit with EtherNet/IP* for information on functions that cannot be manipulated in the EtherNet/IP Network Window

SECTION 4

Editing Safety I/O Terminal Parameters

4-1	Editing Parameters	104
4-1-1	Setting Parameters Using the Wizard	104
4-1-2	Parameter Groups	109
4-1-3	General Parameter Group	110
4-1-4	Safety Input Parameter Groups	111
4-1-5	Test Output Parameter Groups	113
4-1-6	Safety Output Parameter Groups	114
4-1-7	Operation Time Parameter Groups	115
4-1-8	Editing I/O Comments	115
4-2	Editing Parameters for Logic Terminals (DST1-XD0808SL-1)	117
4-2-1	Outline	117
4-2-2	Setting Parameters Using the Wizard	118
4-2-3	Editing Safety Logic: Inputs	119
4-2-4	Editing Safety Logic: Outputs	122
4-2-5	Using Application Templates	127

4-1 Editing Parameters

Device parameters can be edited using any of the following methods.

1. Double-click a device icon.
2. Select a device, and then select **Device - Parameter - Edit** from the menu bar.
3. Select a device, and then click the **Edit Parameter** Button on the toolbar.
4. Right-click the device and select **Parameter - Edit**.
5. Select the device, and then select **Device - Parameter - Wizard**.

Note With Network Configurator version 2.0□ or higher, basic parameters can be set using a wizard. Using this parameter will reduce errors in the parameter settings.

4-1-1 Setting Parameters Using the Wizard

With Configurator Ver. 2.0□ or higher, I/O parameters for DST1-series Controllers can be set using a wizard. This section explains the procedure.

1. Select a DST1-series Controller, and then select **Device - Parameter - Wizard**. The following window will be displayed.
If there are no output terminals (DST1-ID12SL-1), the window for setting input terminals will be displayed.

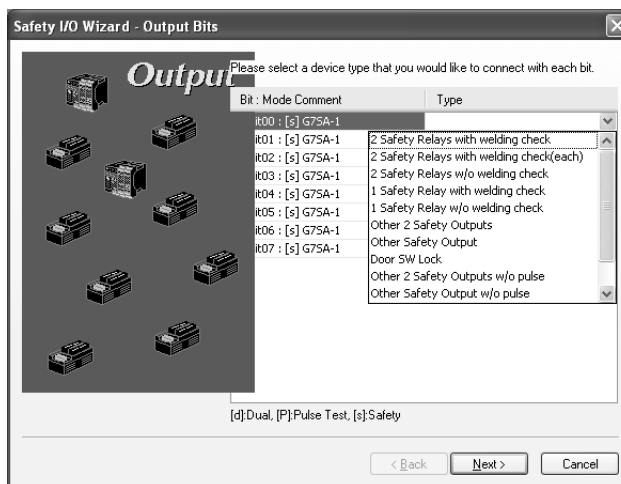

2. In the window above, specify the type of device to be connected to each terminal. The following types can be specified.

Type	Description
2 Safety Relays with welding check (See note 1.)	Specify to connect to two Safety Relay outputs (with welding check for each).
2 Safety Relays w/o welding check (See note 1.)	Specify to connect to two Safety Relay outputs (with no welding check).
1 Safety Relay with welding check	Specify to connect to one Safety Relay output (with welding check).
1 Safety Relay w/o welding check	Specify to connect to one Safety Relay output (with no welding check).
Other 2 Safety Outputs w/o welding check (See note 1.)	Specify to connect to two outputs without welding check.
Other Safety Output w/o welding check	Specify to connect to one output without welding check.
Door SW Lock	Specify to connect to an electromagnetic door switch.

Type	Description
2 Safety Outputs w/o pulse check (See note 1.)	Specify to connect to two outputs that do not require pulse to be checked.
1 Safety Output w/o pulse check	Specify to connect to one output that does not require pulse to be checked.
2 Contactors with welding check (See note 1.)	Specify to connect to two contactor outputs (with welding check for each).
2 Contactors w/o welding check (See note 1.)	Specify to connect to two contactor outputs (with no welding check).
1 Contactor with welding check	Specify to connect to one contactor output (with welding check).
1 Contactor w/o welding check	Specify to connect to one contactor output (with no welding check).
Other Standard Output	Specify to use the output for non-safety applications.
Not Use	Specify to not use the output.

Note Can be selected only when the terminal number is an even number.

- The following dialog box will be displayed if a type with welding check is selected when the terminal is set.

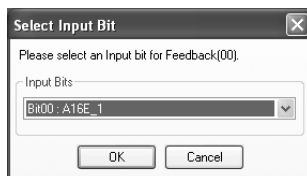

- In this dialog box, select the input for which welding is to be checked, and then click the OK Button.

3. Click the **Next** Button.
The window for setting input terminals will be displayed.

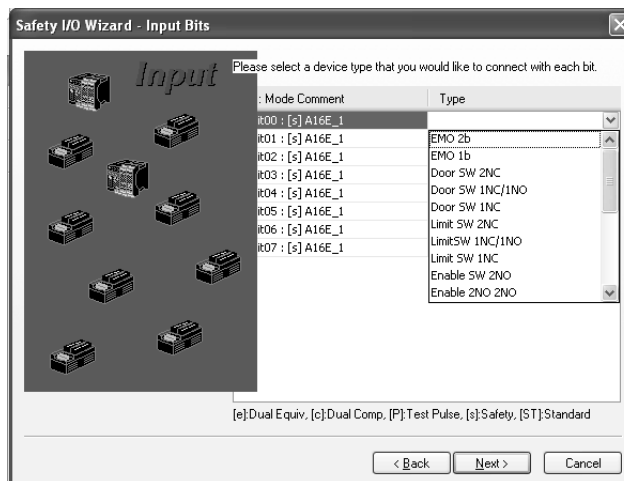

4. In the above window, specify the type of device to be connected to each terminal. The following types can be specified.

Type	Description
EMO 2b (DPST-NC, see note 1.)	Specify to connect two inputs from an emergency OFF button.
EMO 1b (SPST-NC)	Specify to use one input from an emergency OFF button.

Type	Description
Door SW 2NC (See note 1.)	Specify to use two inputs (both NC) from a door switch.
Door SW 1NC/1NO (See note 1.)	Specify to use two inputs (NC and NO) from a door switch.
Door SW 1NC	Specify to use one input from a door switch.
Limit SW 2NC (See note 1.)	Specify to use two inputs (both NC) from a limit switch.
Limit SW 1NC/1NO (See note 1.)	Specify to use two inputs (NC and NO) from a limit switch.
Limit SW 1NC	Specify to use one input from a limit switch.
Enable SW 2NO (See note 1.)	Specify to use two inputs from an enable switch.
Enable SW 4NO (See note 2.)	Specify to use four inputs from an enable switch.
Two Hand Switch (See note 1.)	Specify to use two inputs from a two hand switch.
Other 2NC (See note 1.)	Specify to use input from other 2-NC devices.
Other 2NO (See note 1.)	Specify to use input from other 2-NO devices.
Other 1NC/1NO (See note 1.)	Specify to use input from other NC/NO devices.
Other 1NO/1NC (See note 1.)	Specify to use input from other NO/NC contacts.
Other 1NC	Specify to use other 1-NC devices.
SLC 2 outputs (See note 1.)	Specify to use two inputs from a light curtain.
SLC 1 output	Specify to use one input from a light curtain.
Other PNP 2 outputs (See note 1.)	Specify to use two inputs from other semiconductors.
Other PNP output	Specify to use one input from other semiconductors.
Reset SW	Specify to use inputs from a reset switch.
Welding check (EDM input)	Specify to use as feedback signal to EDM.
Standard SW	Specify to use inputs from a switch for non-safety applications.
Not Use	Specify to not use the input.

Note

- (1) Can be selected only when the terminal number is an even number.
 - (2) Can be selected only when the terminal number is an even number and there are at least four remaining terminals.
5. Click the **Next** Button. If there are output terminals (e.g., DST1-MD12SSL-1), the following dialog box will be displayed.

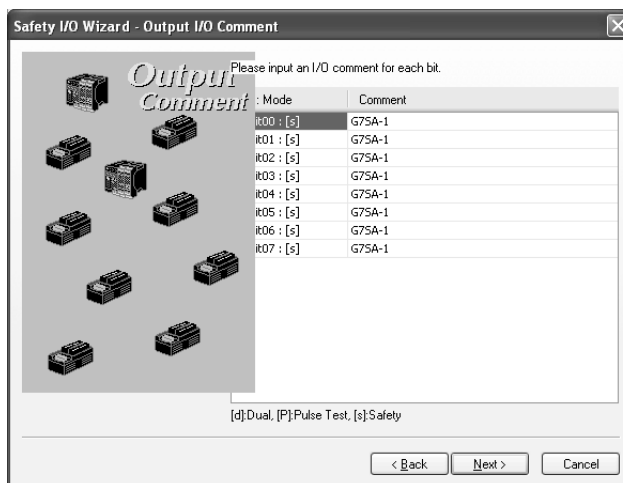

Comments for each output terminal can be edited in this window.

- After making the settings, click the **Next** Button. The following dialog box will be displayed. Comments for each input terminal can be edited in this dialog box.

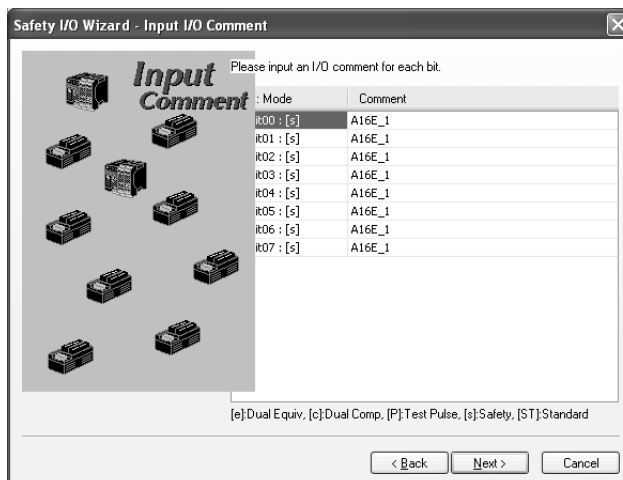

- After making the setting, click the **Next** Button. As shown in the following figure, the details set using the wizard will be listed.

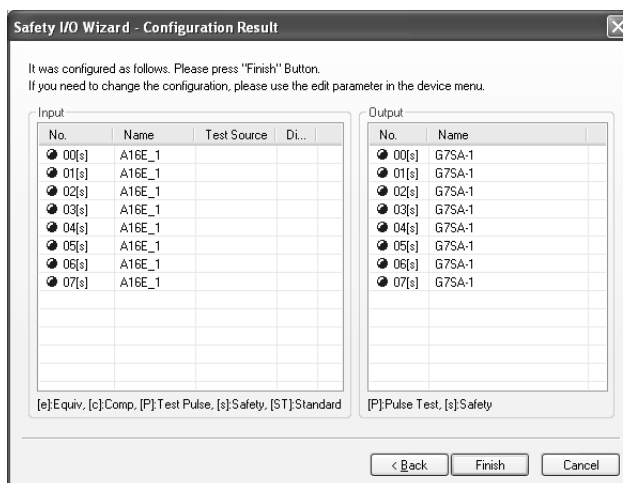

- After checking the settings, click the **Finish** Button. The following dialog box will be displayed.

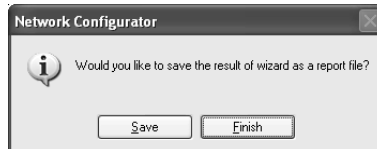

9. Click the **Save** Button. The items set with the wizard will be saved in HTML. The file can be viewed using a web browser.
(After this, the Edit Logic Dialog Box will be displayed for the Logic Terminal (DST1-XD0808SL-1). (Refer to 4-2 *Editing Parameters for Logic Terminals (DST1-XD0808SL-1)*.)

Note I/O tag names and I/O comments (names) cannot consist of only spaces.

4-1-2 Parameter Groups

Safety I/O Terminal parameters are classified into groups as shown in the following diagram.

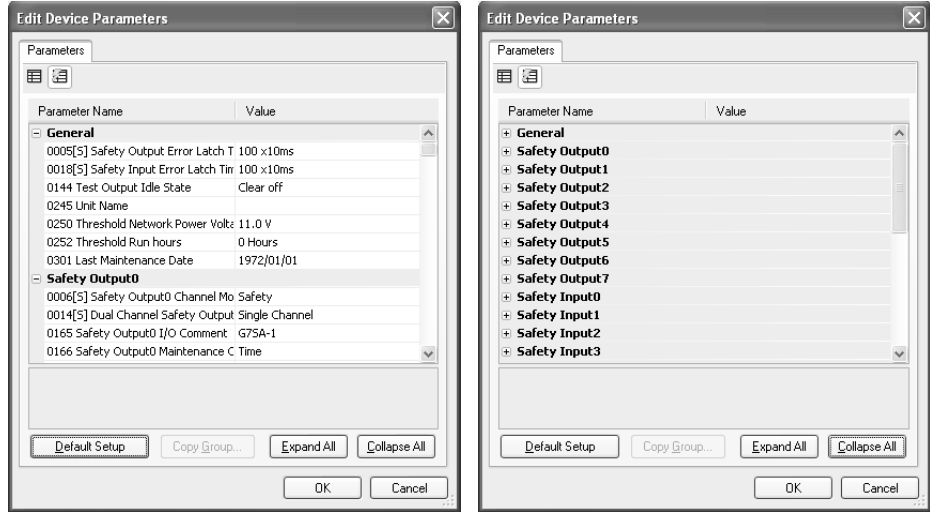

- Double-click a group name or click the icon to display or hide that group.
- Parameter settings for a particular terminal can be batch copied to the parameters for another terminal.

The **Copy Group** Button is enabled when a group name is selected and a group with a different terminal number but similar parameters exists, e.g., when safety input 0 is selected and safety input 1 or safety input 2 exists. Click the **Copy Group** Button to display the Group Copy Dialog Box shown below.

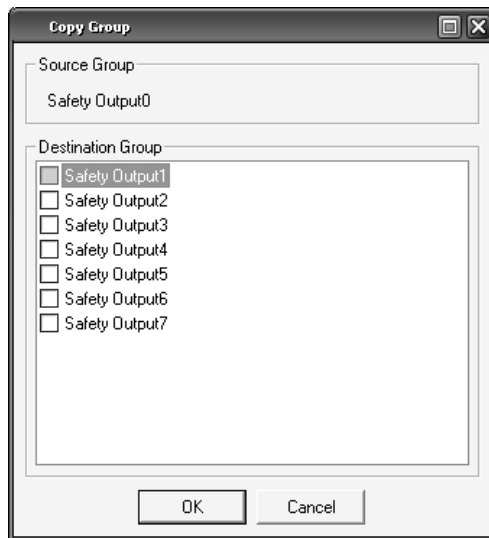

The source and destination groups will be displayed. Select the desired destination groups and then click the **OK** Button. The parameters will be copied.

- Parameter names with [S] in front of them are related to the safety application.
- The size of the Edit Device Parameters Window can be changed.

4-1-3 General Parameter Group

This section describes parameters in the general parameter group.

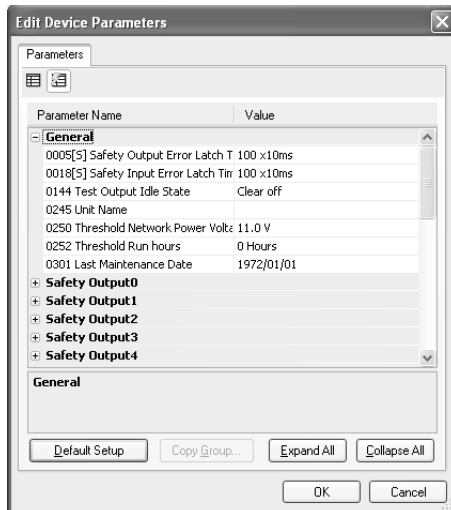

	Item	Settings	Description	Default
S	Safety Output Error Latch Time	0 to 65,530 ms (in 10-ms increments)	This parameter is common to all the safety outputs. It sets the time to latch the error state when an error occurs in these outputs. Even when the cause of the error has been removed, the error state will remain latched for the time set here.	1,000 ms
S	Safety Input Error Latch Time	0 to 65,530 ms (in 10-ms increments)	This parameter is common to all safety inputs and test outputs. It sets the time to latch the error state when an error occurs in these inputs/outputs. Even when the cause of the error has been removed, the error state will remain latched for the time set here.	1,000 ms
	Test Output Idle State	Clear off	This parameter is common to all test outputs for which the Test Output Channel Mode is set to <i>Standard Output</i> . It sets the output state of the test output when idle data is received.	Clear off
		Keep output data		
	Unit Name	32 characters max.	This parameter sets a user-chosen name for the Safety I/O Terminal. The set name is saved in the Safety I/O Terminal and displayed in the network configuration.	None
	Threshold Network Power Voltage	8.0 to 30.0 V	This parameter sets the threshold of the network power voltage. When the voltage falls below the set threshold voltage, the corresponding bit in general status turns ON.	11.0 V
	Threshold Run Hours	0 to 429,496,729 hours	This parameter sets the threshold for unit operating hours. When the operating hours exceeds the set threshold, the corresponding bit in general status will turn ON.	0 hours
	Last Maintenance Date	January 1, 1972 to January 19, 2038	This parameter saves the maintenance date in the Safety I/O Terminal.	January 1, 1972

4-1-4 Safety Input Parameter Groups

This section describes parameters in the safety input parameter groups. The safety input parameters are grouped by terminal number.

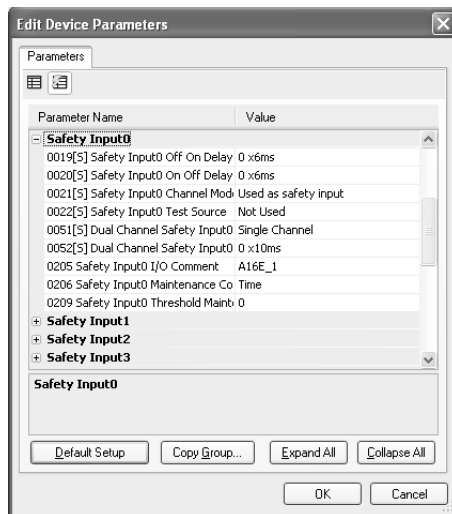

	Item	Settings	Description	Default
S	Off On Delay	0 to 126 ms (in 6-ms increments)	Sets the OFF/ON delay time.	0 ms
S	Off On Delay	0 to 126 ms (in 6-ms increments)	Sets the OFF/ON delay time.	0 ms
S	Safety Input Channel Mode	Not used.	The safety input is not used. (External input device not connected.)	Not used.
		Test pulse from test out	Specifies connecting a device with a contact output in combination with a test output. When this mode is selected, select the test output to use for the test source and then set the test output mode to <i>Pulse Test Output</i> . When these settings are made, contact between the input signal line and the power supply (plus) and short circuits with other input signal lines can be detected.	
		Used as a safety input.	Specifies connecting a safety device with a semiconductor output, such as a light curtain.	
		Used as a standard input.	Specifies connecting a standard device (i.e., a non-safety device).	
S	Test Source	Not used.	If the channel mode of a safety input is set to <i>Test Pulse from Test Out</i> , the test output is selected for use in combination with the safety input. Set the channel mode of the test output selected here to <i>Pulse Test Output</i> .	Not used.
		Test Output 0		
		Test Output 1		
		Test Output 2		
		Test Output 3		
S	Dual Channel Safety Input Mode	Single Channel	Specifies using Single Channel Mode. If <i>Single Channel</i> is selected, the safety input that would be paired for the dual channel parameter will also be set to Single Channel Mode.	Dual Channel Equivalent
		Dual Channel Equivalent	Specifies using the Dual Channel Equivalent Mode with a paired safety input.	
		Dual Channel Complementary	Specifies using Dual Channel Complementary Mode with a paired safety input.	

	Item	Settings	Description	Default
S	Dual Channel Safety Input Discrepancy Time	0 to 65,530 ms (in 10-ms increments)	Sets the time to monitor the logic discrepancy in the dual channel input logic.	0 ms
	I/O Comment	32 characters max.	Sets an I/O comment for the safety input. The I/O comment set here is used as the I/O tag in the Logic Editor.	None
	Maintenance Counter Mode Choice	Time (total ON time)	Sets the operating mode for the maintenance counter.	Time
		Count (operation count)		
	Threshold Maintenance Counter	0 to 4,294,967,295 hours	Sets the threshold value for the maintenance counter.	0

IMPORTANT When the Safety Input Channel Mode is set to *Test Pulse from Test Out*, specify the test output to use for the test source and set the Test Output Channel Mode of the test output to *Pulse Test Output*.

4-1-5 Test Output Parameter Groups

This section describes parameters in the test output groups. The test output parameters are grouped by terminal number.

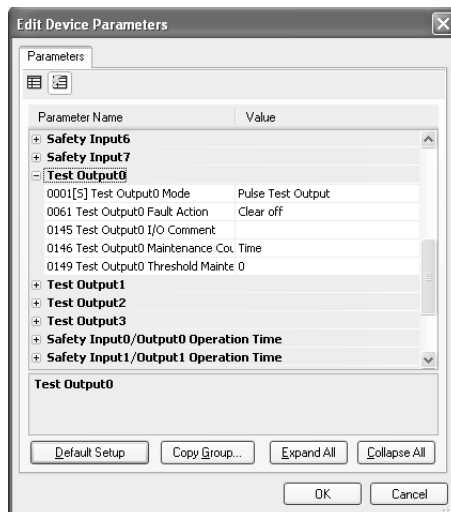

	Item	Settings	Description	Default
S	Test Output Mode	Not used.	The corresponding test output is not used.	Not used.
		Standard Output	Specifies connecting to the input for a muting lamp or PLC. Used as a monitor output.	
		Pulse Test Output	Specifies connecting a device with a contact output in combination with the safety input.	
		Power Supply Output	Specifies connecting to the power supply terminal of a safety sensor. The voltages supplied to the I/O power from the test output are output.	
		Muting Lamp Output (Setting supported only for T3 terminal.)	Specifies a muting lamp output. When the output is ON, disconnection of the muting lamp can be detected.	
	Fault Action	Clear off	Sets the output state of the test output when a communications error occurs.	Clear off
		Hold last data	This parameter is enabled when the Test Output Channel Mode is set to <i>Standard Output</i> or <i>Muting Lamp Output</i> .	
	I/O Comment	32 characters max.	Sets an I/O comment for the test output. The I/O comment set here is used as the I/O tag in the Logic Editor.	None
	Maintenance Counter Mode Choice	Time (total ON time)	Sets the operating mode for the maintenance counter.	Time
		Count (operation count)		
	Threshold Maintenance Counter	0 to 4,294,967,295 hours	Sets the threshold value for the maintenance counter.	0

4-1-6 Safety Output Parameter Groups

This section describes parameters in the safety output groups. The safety output parameters are grouped by terminal number.

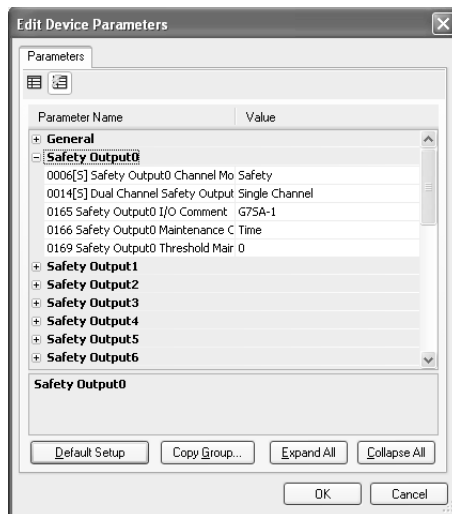

	Item	Settings	Description	Default
S	Safety Output Channel Mode	Not used.	The safety output is not used. (External output device not connected.)	Not used.
		Safety	Specifies not outputting the test pulse when the output is ON. Contact between the output signal line and the power supply (positive) when the output is OFF and ground faults can be detected.	
		Safety Pulse Test (Setting supported only for the DST1-MD16SL-1.)	Outputs the test pulse when the output is ON. Contact between the output signal line and the power supply, and short circuits with other output signal lines can be detected.	
S	Dual Channel Safety Output Mode	Single Channel	Specifies using Single Channel Mode. When <i>Single Channel</i> is set, the safety output that would be paired for the dual channel parameter is also set to Single Channel Mode.	Dual Channel
		Dual Channel	Specifies using Dual Channel Mode. When both of the safety outputs to be paired are normal, the outputs can be turned ON.	
	I/O Comment	32 characters max.	Sets an I/O comment for the safety output. The I/O comment set here is used as the I/O tag in the Logic Editor.	None
	Maintenance Counter Mode Choice	Time (total ON time)	Sets the operating mode for the maintenance counter.	Time
		Count (operation count)		
	Threshold Maintenance Counter	0 to 4,294,967,295 hours	Sets the threshold value for the maintenance counter.	0

4-1-7 Operation Time Parameter Groups

This section describes parameters in the safety input/output operation time groups. The operation time parameters are grouped by the terminal numbers to be paired.

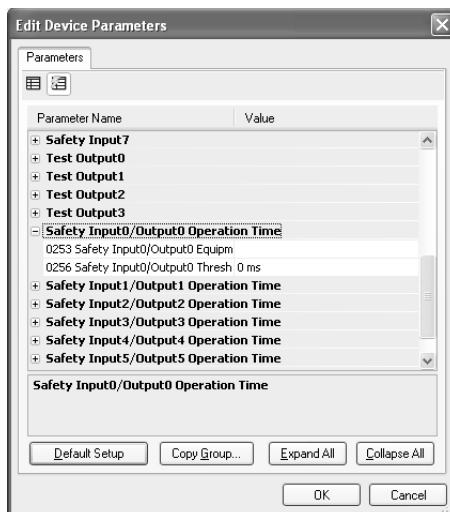

	Item	Settings	Description	Default
	Equipment Name	32 characters max.	Sets a comment for the operation time to monitor.	None
	Threshold Response Time	0 to 65,535 ms (in 1-ms increments)	Sets the threshold value for the operation time.	0 ms

4-1-8 Editing I/O Comments

I/O comments can be edited by setting the safety input terminals and safety output terminals. The edited comments here are used as I/O tags in the Logic Editor.

In the following procedure, separate I/O tags for safety input terminals and safety output terminals are edited in one window.

1. Select **Device - Edit I/O Comments**. The following window will be displayed.

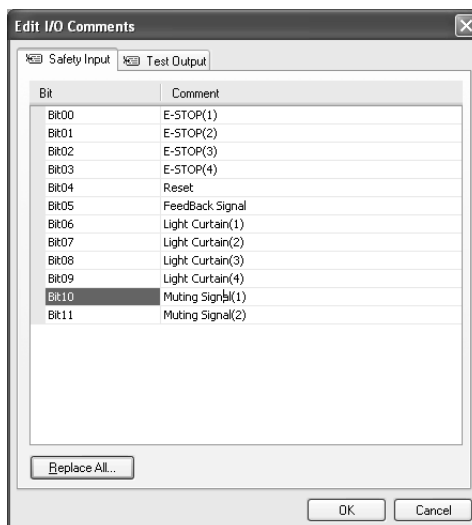

2. Edit each terminal comment, and then click the **OK** Button.
The following window will be displayed.

With Configurator Ver. 2.0□ or higher, the following procedure can be used to replace I/O comments.

1. Click the **Replace All** Button in the window above. The following window will be displayed.

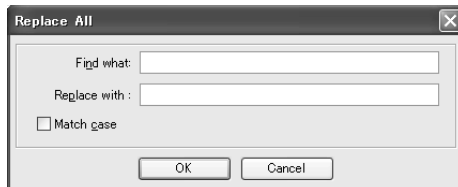

2. Input the character string to be searched for and the characters it is to be replaced with, and then click the **OK** Button. The comments will be replaced.

Note With Network Configurator version 2.0□ or higher, the following toolbar icons will be displayed at the top of the Edit Device Parameters Window.

 : Standard Mode

 : Expansion Mode

These buttons can be used to switch between displaying or hiding expansion parameters. Normally, device settings are made using only parameters displayed in Standard Mode.

Note I/O tag names and I/O comments (names) cannot consist of only spaces.

4-2 Editing Parameters for Logic Terminals (DST1-XD0808SL-1)

4-2-1 Outline

Logic Terminals (DST1-XD0808SL-1) can be used with Network Configurator version 2.0 or higher.

A Logic Terminal provides built-in logic operations. This feature enables local outputs to be controlled directly by local inputs, shortening the reaction time.

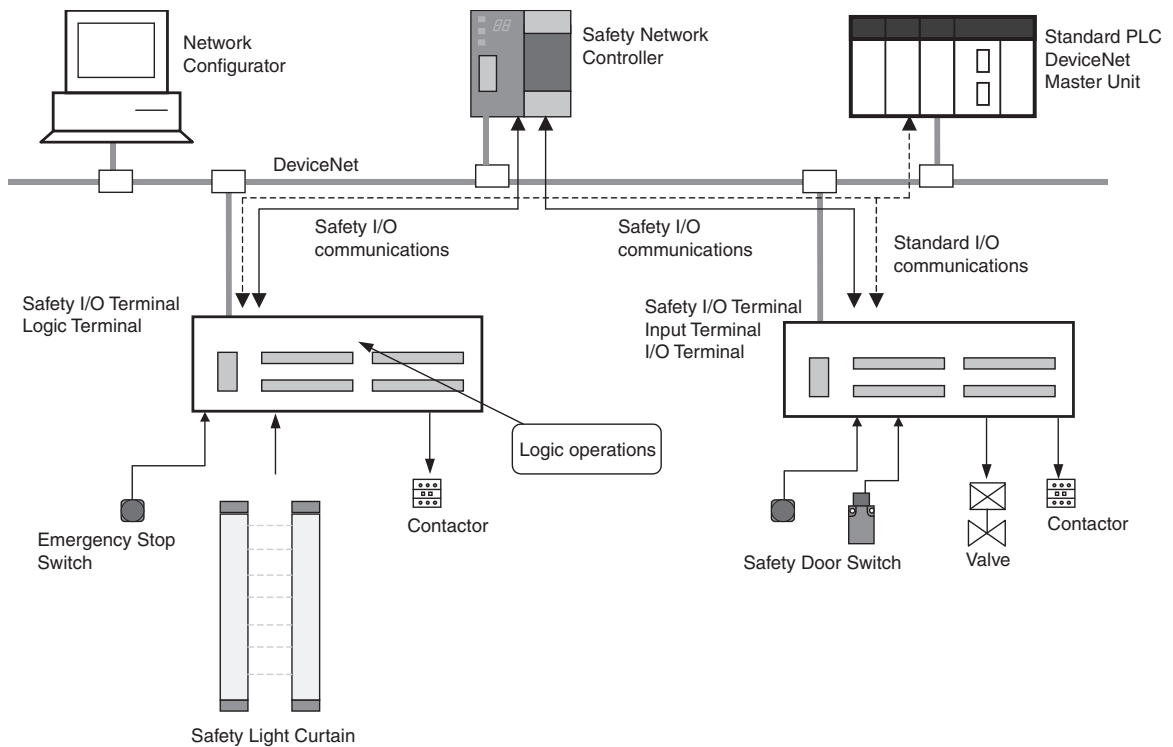

One of the following methods can be used to edit parameters for a Logic Terminal.

- 1,2,3...** 1. Select a device, and select **Device - Parameter - Wizard** from the menu bar.
2. Select a device, and click the **Parameter Wizard** Button on the toolbar.
3. Right-click the device and select **Parameter - Wizard** from the pop-up menu.

4-2-2 Setting Parameters Using the Wizard

- 1,2,3... 1. Select the Logic Terminal (DST1-XD0808SL-1), and select **Device - Parameter - Wizard** from the menu bar. The following dialog box will be displayed.

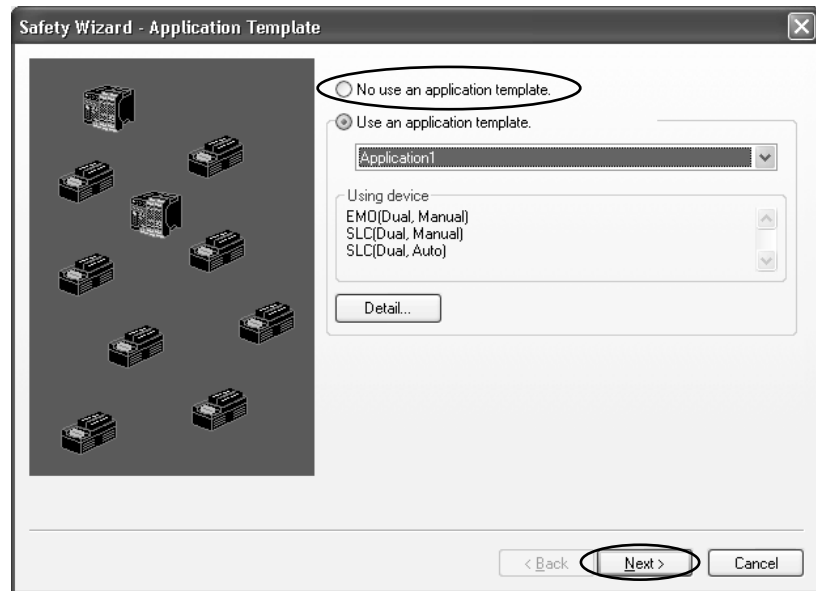

2. Select the **No use an application template** Option and click the **Next** Button. (Refer to 4-2-5 *Using Application Templates* for information on using application templates.) The following dialog box will be displayed.

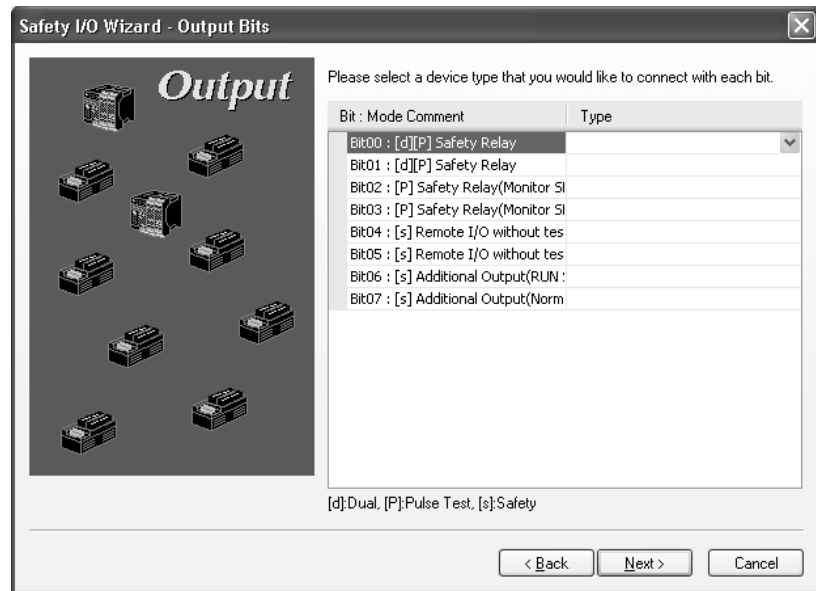

3. Select all the output devices to connect (the parameter options are the same as for the DST1-MD169SL-1) and click the **Next** Button.
- Each time you click the **Next** Button after this, the Input Bits, Output I/O Comment, and Input I/O Comment Dialog Boxes will be displayed. Select the parameters in each dialog box.

- When the **Next** Button is clicked in the Input I/O Comment Dialog Box, the Configuration Result Dialog Box will be displayed.

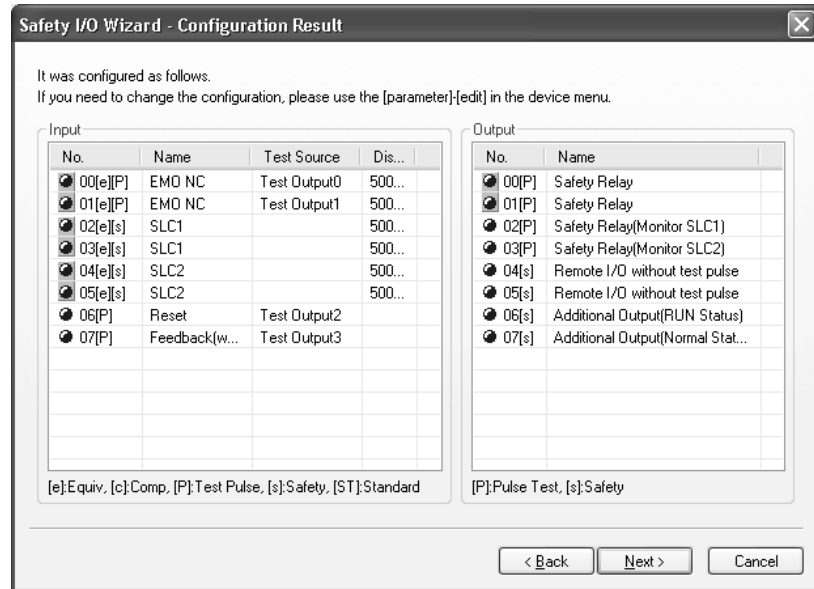

4. Check the configuration results and click the **Next** Button. The Safety Logic Wizard Input Dialog Box (Edit Safety Logic Dialog Box for inputs) will be displayed.

4-2-3 Editing Safety Logic: Inputs

Click the **Next** Button at the Configuration Result Dialog Box shown in step 4 in 4-2-2 *Setting Parameters Using the Wizard* to display the Safety Logic Wizard - Input Dialog Box (the dialog box to edit safety logic for input).

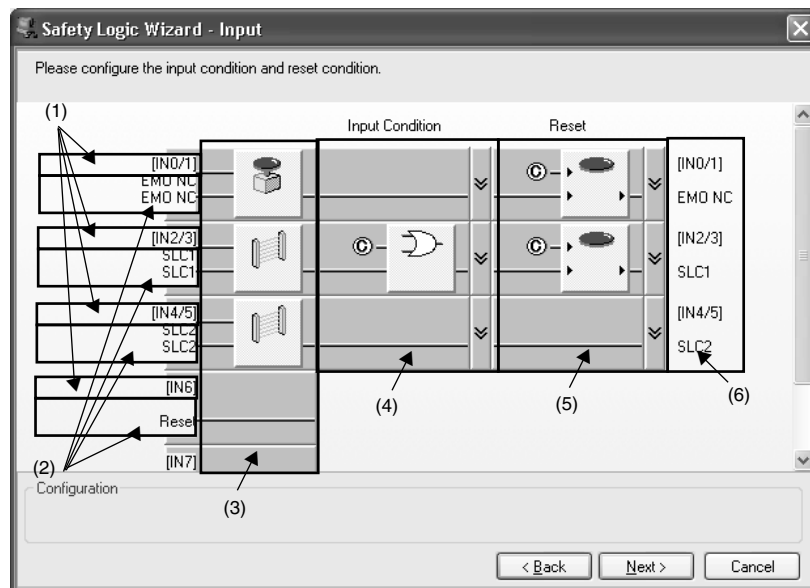

The Safety Logic can be edited in this dialog box. Each item has the following meaning.

1. Terminal No.

Displays the terminal number being used. If a device with two inputs is selected at the Input Bits Dialog Box, the corresponding two inputs will be displayed (e.g., IN0/IN1).

2. Terminal Name

The comment that was set in the Input I/O Comment Dialog box will be displayed.

3. Input Function Block

The function block selected in the Input Bits Dialog Box will be displayed automatically. If a device with two inputs is selected, two inputs will be used for the function block (e.g., If EMO 2b is selected, IN0/IN1 will be used).

4. Input Conditions

(Refer to *Selecting Input Conditions*)

5. Reset Conditions

(Refer to *Selecting Reset Conditions*)

6. Safety Input Logic Configuration Results

These are the terminal names that are used for the output logic.

The terminal names are automatically set by the wizard.

To change them, set the Safety Logic Comments in the Parameters Dialog Box.

Use the following procedure for the Input Dialog Box for the Safety Logic Wizard.

Selecting Input Conditions

Use the following procedure to select the input conditions.

- 1,2,3... 1. Click the selection button shown in the following figure.

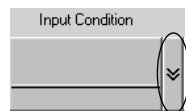

The following options will be displayed.

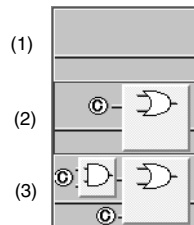

2. Select the desired input condition.
The options are as follows:
(1) No Input Condition
Input condition is not specified.

(2) Specify Input Condition with Logical OR Only

When this option is selected, the input condition can be selected from the options shown in the following figure.

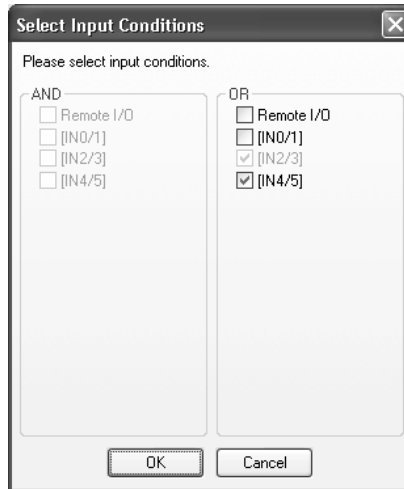

(3) Specify Input Condition with Logical AND or OR

When this option is selected, the input condition can be selected from the options shown in the following figure.

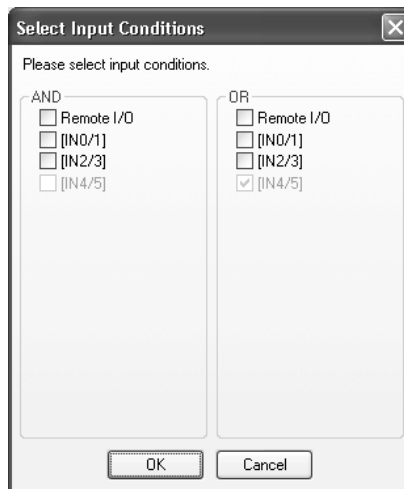

Selecting Reset Conditions

The procedure for selecting the reset conditions is given below.

1,2,3...

1. Click the selection button shown in the following figure.



The following options will be displayed.

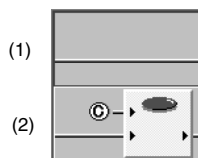

2. Select a reset condition. The options are as follows:

- (1) No Reset Signal
Reset signal is not specified.
- (2) Reset Signal
A reset signal is specified. The following dialog box will be displayed and the reset signal can be specified.

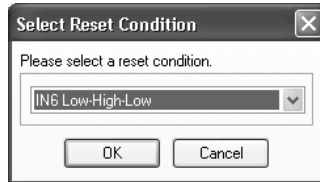

- Inputs that can be set as the reset signal are as follows.
 - Remote I/O Signal Low-High-Low
 - Remote I/O Signal Rising Edge
 - IN6 Low-High-Low
 - IN6 Rising Edge
 - IN7 Low-High-Low
 - IN7 Rising Edge
- The following dialog box will be displayed when setting is completed.
- If modification is required after completing the settings, click the **Disable Input** or **Reset** Button to enable making changes.

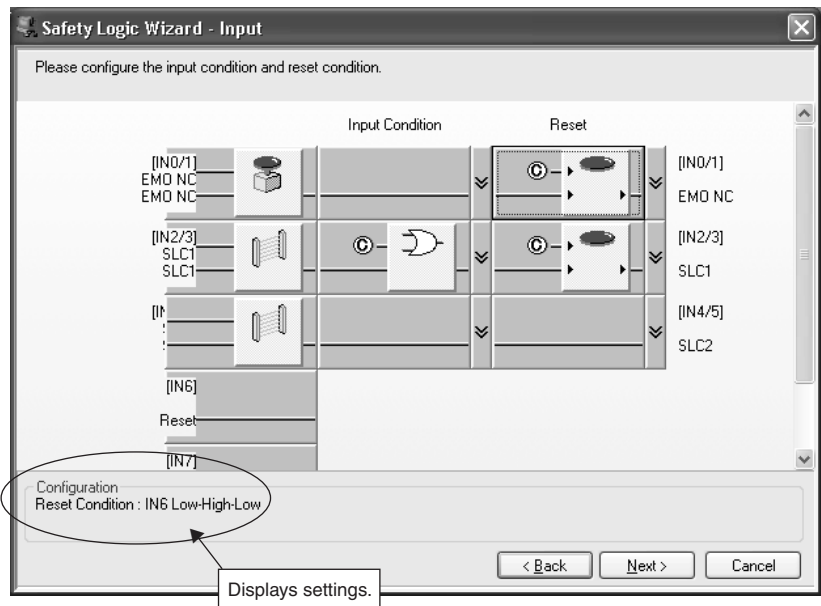

- 3. When the settings have been completed, click the **Next** Button. The Safety Logic Wizard - Output Dialog Box (the dialog box to edit safety logic for outputs) will be displayed.

4-2-4 Editing Safety Logic: Outputs

Click the **Next** Button in the Configuration Result Dialog Box in step 3 in 4-2-3 *Editing Safety Logic: Inputs* to display the following Safety Logic Wizard - Output Dialog Box (the dialog box to edit safety logic for output).

You can set the output conditions, welding check (EDM), and the terminal modes in this dialog box.

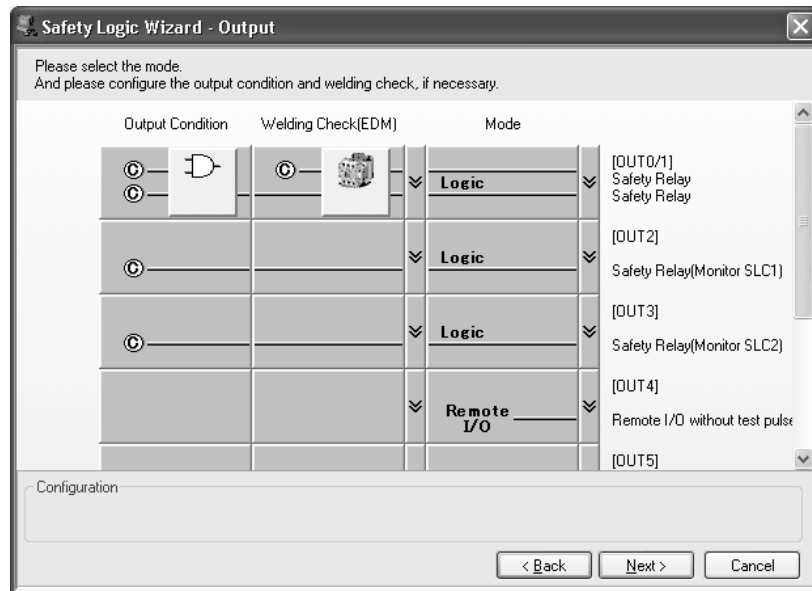

Selecting the Mode

- 1,2,3... 1. Click the selection button shown in the following figure.

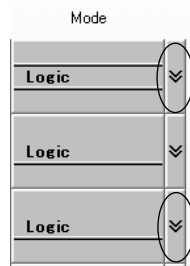

Corresponding output terminals are used as a dual output (e.g., 2 Safety Relays).

The following options will be displayed.

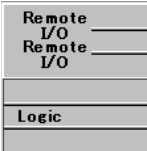
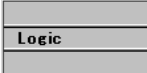
- (1) 
- (2) 

2. Select the output condition.
The options are as follows:

- (1) Remote I/O Output
Outputs the signal that the logic terminal received from the Safety Master.
When this option is selected, the result of the internal logic is ignored.

(2) Output from Logic

The result of the internal logic is output to the local output terminal.

The output condition can be selected from the following list.

(The condition depends on the input settings. For example, if Input0 and Input1 are used as a single input, Input0/1 becomes Input0, Input1.)

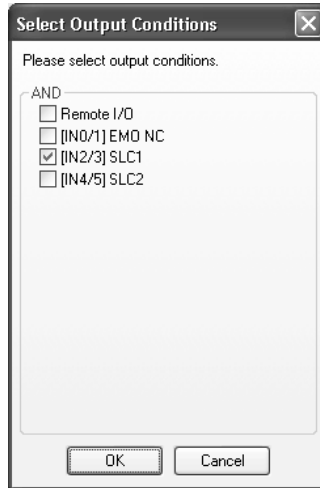

Corresponding output terminal is used as single output (e.g., 1 Safety Relay).

The following options will be displayed.

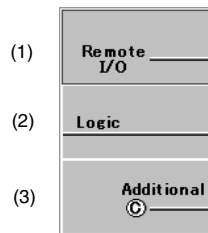

3. Select the logic condition from the following options.

(1) Output from the Network

Outputs the signal that the logic terminal received from Safety Master.

When this option is selected, the result of the internal logic is ignored.

(2) Output from the Logic

The result of the internal logic is output to the local output terminal. The output condition can be selected from the following list. (The condition depends on the input settings. For example, if IN0 and IN1 are used as a single input, IN0/1 becomes IN0, IN1.)

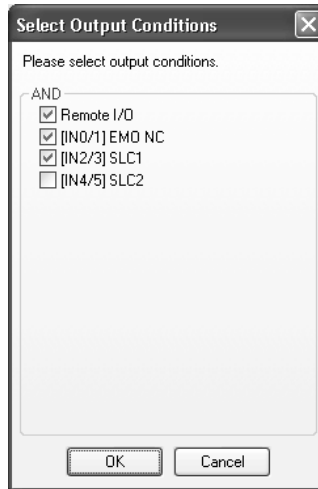

(3) Auxiliary Output

The safety output is used as an auxiliary output. Select the data to output as the auxiliary output. The data can be selected from the following.

OUT0	Output the same value as OUT0.
OUT0 (NOT)	Output the inverted value of OUT0.
OUT2	Output the same value as OUT2.
OUT2 (NOT)	Output the inverted value of OUT2.
OUT4	Output the same value as OUT4.
OUT4 (NOT)	Output the inverted value of OUT4.
OUT6	Output the same value as OUT6.
OUT6 (NOT)	Output the inverted value of OUT6.
Reset Required Indication	Outputs a signal flashing at 1 Hz to prompt for a reset input. The signal is output when more than one terminal can be reset from all the safety input terminal reset operations.
RUN Status	Outputs the operating mode. 0: Other than RUN 1: RUN
Normal Status	Outputs normal status. 0: Error 1: Normal

Setting the Welding Check (EDM)

- 1,2,3... 1. Click the selection button shown in the following figure.

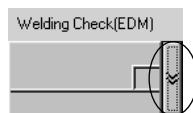

The following options will be displayed. (Valid only when the terminal mode is set to output from logic.)

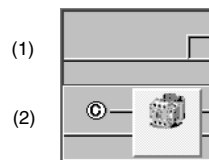

2. Select whether to enable or disable the EDM function.

The options are as follows:

(1) Disable EDM Function

The EDM function is not used.

(2) Enable EDM Function

The EDM function is used. Select a terminal to receive the feedback signal from an external device. It can be any terminal from IN4 to IN7.

Setting Output Conditions

When output from logic is selected as the terminal mode, the following figure will be displayed for the output condition.

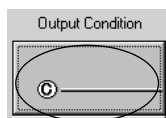

(If a mode other than output from logic is selected, the following figure will be displayed.)



Click the selection button when the above figure is displayed to enable selecting the output condition.

Set an AND operation of the safety input logic configuration result and the value received from the network (interlock signal).

If multiple AND conditions (e.g., IN0 and IN1) are selected, the following dialog box will be displayed.

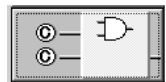

When the settings have been completed, press the **Next** Button to display the following dialog box.

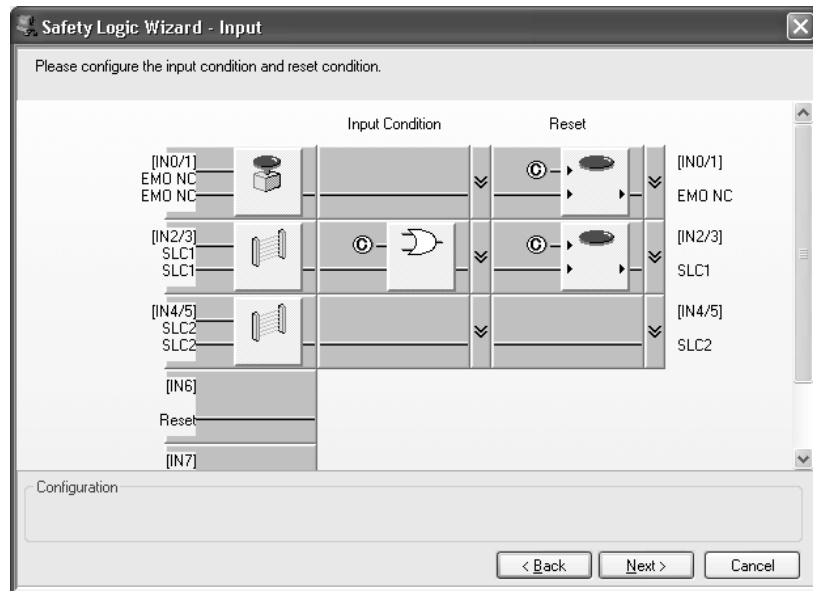

This completes the settings. Click the **OK** Button. The dialog box will close.

4-2-5 Using Application Templates

Application templates have preset parameters for each application, making it easier to set the Logic Terminal parameters. This section describes how to use the application templates.

- 1,2,3... 1. Select the Logic Terminal (DST1-XD0808SL-1), and select **Device - Parameter - Wizard** from the menu bar. The following dialog box will be displayed.

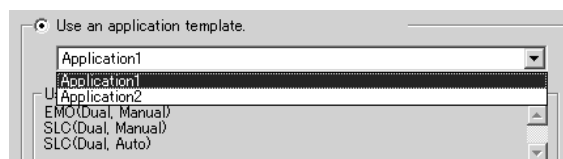
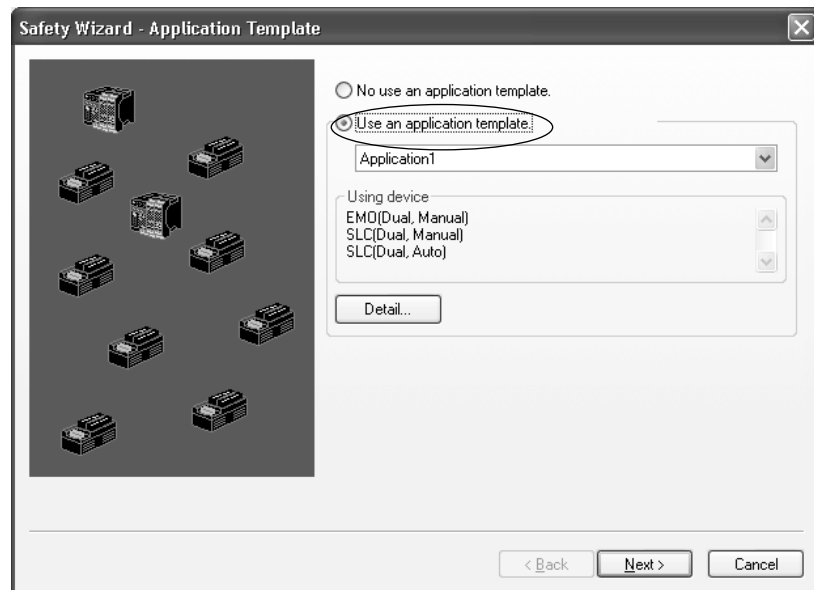

2. Select the **Use an application template** Option shown above, and select the type of application template to use. Click the **Detail** Button to display a file with the details of the selected application.
3. Click the **Next** Button. The following Output Bits Dialog Box will be displayed.

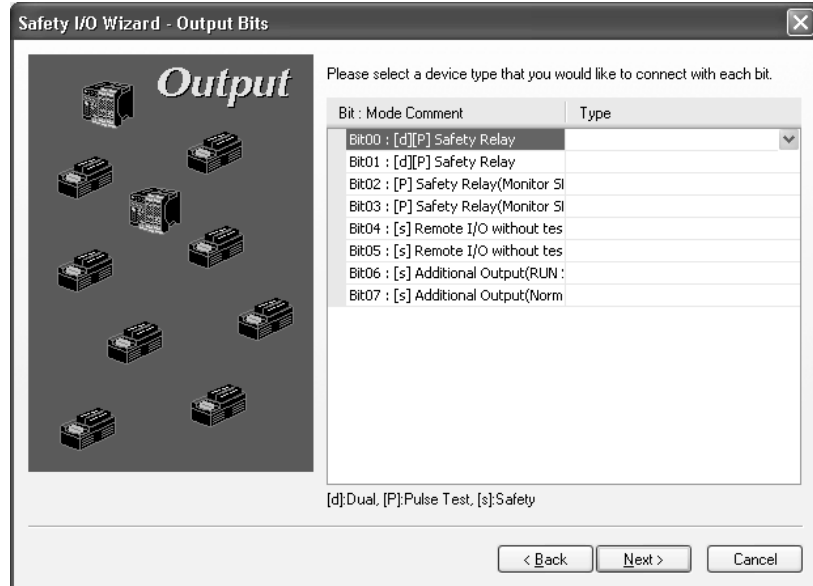

This dialog box displays the preset parameters for the chosen application template.

4. You can make changes to the parameters as required. When finished, click the **Next** Button.
 - Each time you click the **Next** Button after this, the Input Bits Dialog Box, Output I/O Comment Dialog Box, and Input I/O Comment Dialog Box will be displayed. Check the parameters in each dialog box and make any changes that are required.
 - Click the **Next** Button on the Input I/O Comment Dialog Box to display the following Configuration Result Dialog Box.

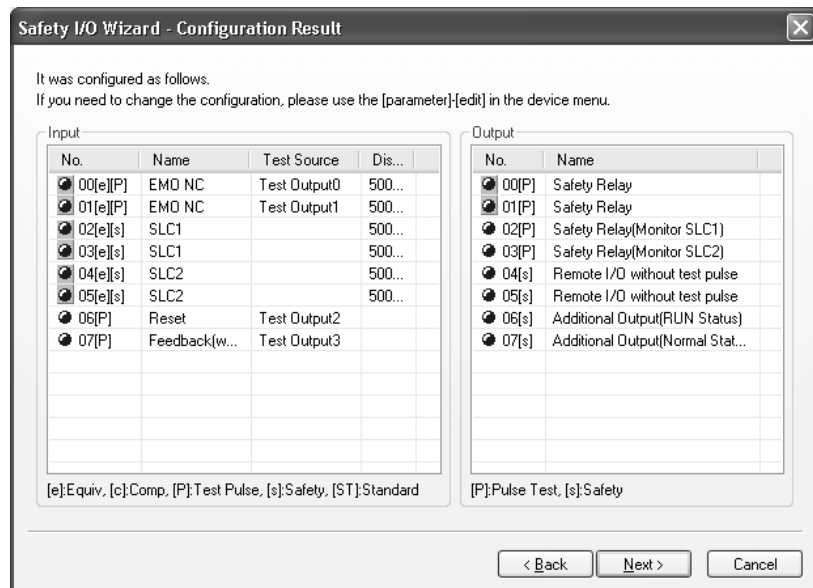

5. Check the settings and click the **Next** Button.
The following Safety Logic Wizard - Input Dialog Box (the dialog box to edit safety logic for inputs) will be displayed.

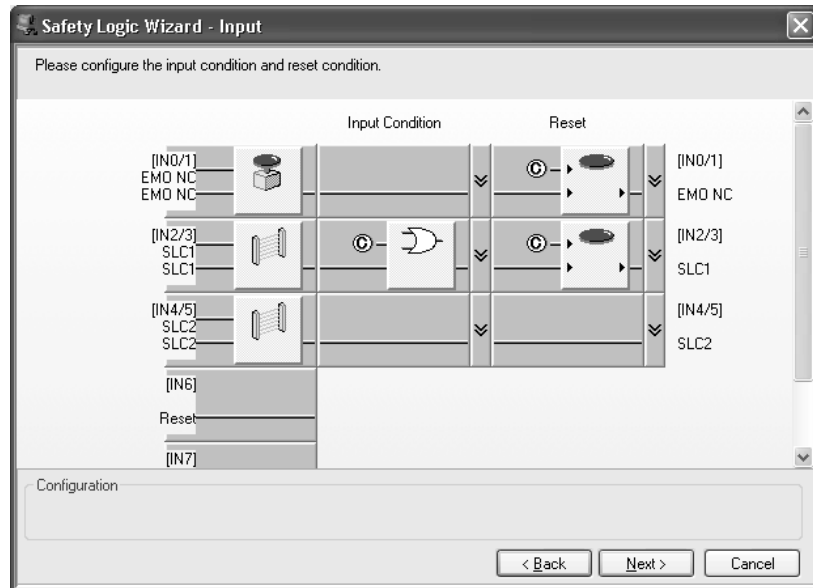

6. Check the logic and make any changes as required. Click the **Next** Button.
The Safety Logic Wizard - Output Dialog Box (the dialog box to edit safety logic for output) will be displayed.

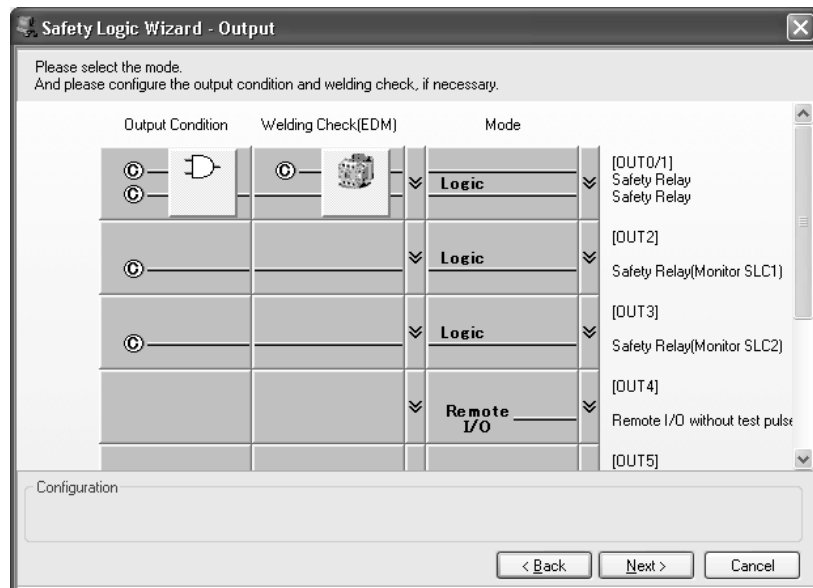

7. Check the logic and make any changes as required. Click the **Next** Button.
A confirmation dialog box will be displayed.
8. Check that the settings are correct, and then click the **OK** Button. This completes the settings.

SECTION 5

Editing Safety Network Controller Parameters

5-1	Safety Connection Settings	132
5-1-1	Registering Safety Slaves	132
5-1-2	Setting Safety Connection Parameters	135
5-1-3	Stopping/Restarting Communications after an Error	140
5-1-4	Listing and Setting Connection Parameters	142
5-2	Safety Slave Settings	143
5-2-1	Registering I/O Assemblies for Safety Slaves	143
5-2-2	Setting Assembly Data	144
5-3	Standard Slave Settings	150
5-3-1	Registering I/O Assemblies for Standard Slaves	150
5-3-2	Setting Slave Input Data in Idle State	151
5-3-3	Setting Assembly Data	151
5-4	Setting the Controller as an EtherNet/IP Standard Target	153
5-4-1	Registering I/O Assemblies for Standard Targets	153
5-4-2	Setting Assembly Data	154
5-5	Local I/O Settings	156
5-5-1	Setting Parameters Using the Wizard	156
5-5-2	Setting Safety Inputs	159
5-5-3	Setting Test Outputs	162
5-5-4	Setting Safety Outputs	163
5-6	Setting the Operating Mode and Confirming the Cycle Time	165
5-6-1	Setting the NE1A-series Controller Operating Mode	165
5-6-2	Confirming the Cycle Time	166
5-6-3	Restarting a Connection Stopped due to a Communications Error	167
5-7	Extend Mode Settings	169
5-7-1	Setting the Operating Mode after a Communications Error	169
5-7-2	Setting the Program Execution Delay	170
5-8	Setting Maintenance Information	171
5-9	Displaying Memory Information	172

5-1 Safety Connection Settings

Open the Edit Device Parameter Window of the NE1A-series Controller and click the **Safety Connections** Tab to display the Safety Connection Setting Window. In this window, you can register the Safety Slaves, such as the DST1-series Safety I/O Terminals, that perform the safety communications and set the communications parameters.

Note Setting parameters in this window is not necessary when the NE1A-series Controller is used with DeviceNet communications disabled (standalone).

5-1-1 Registering Safety Slaves

Use the following procedure to register Safety Slaves as communications destinations.

1. Unregistered devices are listed in the upper pane, and registered devices are listed in the lower pane.

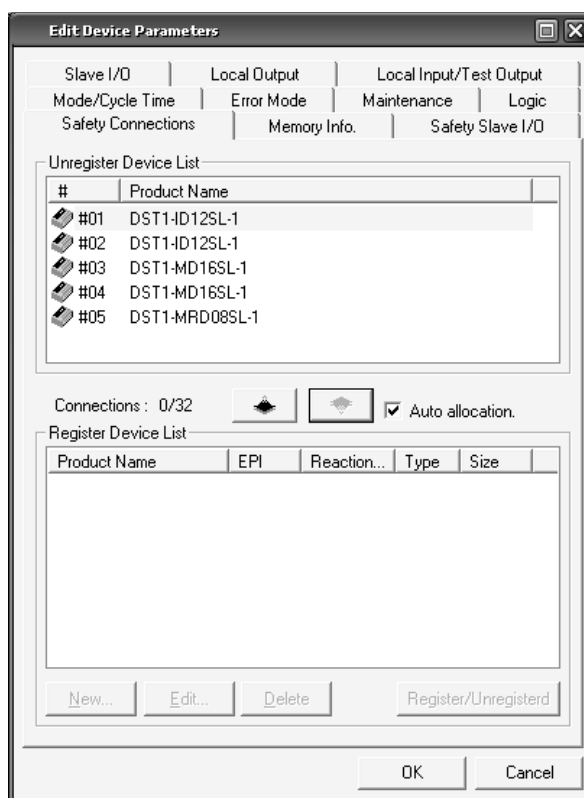

2. Select a Safety Slave to register in the Unregister Device List and click the  Button.
3. The Safety Slave selected in step 2 will be registered. If the *Auto Allocation* Check Box is selected at this point, the default connections and the parameters are will be automatically allocated as shown in the following figure.

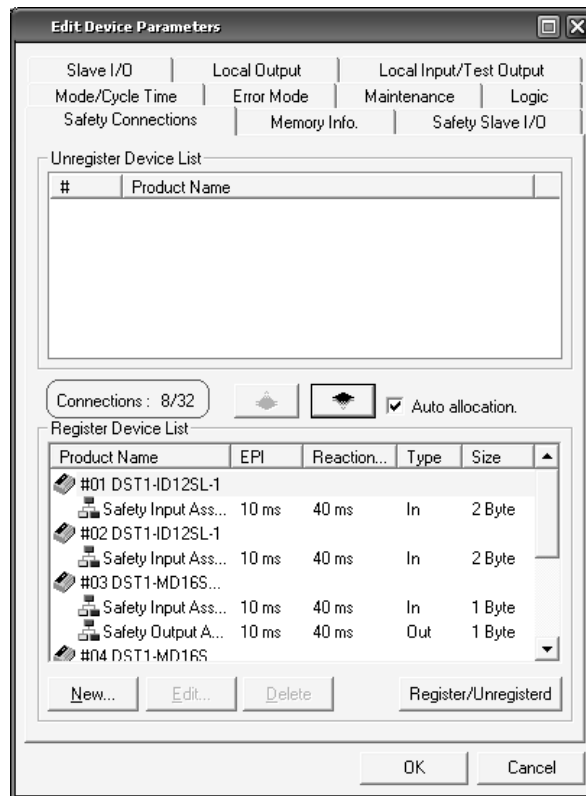

Note With Configurator Ver. 2.0□ or higher, the following procedure can be used to register to a Safety Slave to more than one Safety Master all at once.



- a. Select the safety Slave to be registered, and then select **Device - Register to Another Device - Multi device . . .**. The following dialog box will be displayed.



- b. Select the device to be registered, and then click the **OK** Button. The Safety Slave will be registered to the selected Safety Master.

After registration, the number of connections used and the number of connections that can be used are displayed in the center of the dialog box.

The following information is displayed in the Register Device List.

Item	Information displayed
Product Name	The name of the registered Safety Slave ( icon) or I/O assembly used in the safety connection ( icon) is displayed.
EPI	The EPI for the safety connection is displayed. For details on EPI, refer to <i>5-1-2 Setting Safety Connection Parameters</i> .
Reaction Time	The network reaction time for the safety connection is displayed.
Type	The type of the I/O assembly used in the safety connection is displayed.
Size	The data size of the I/O assembly used in the safety connection is displayed.

4. In the Register Device List, you can add and delete connections and edit the connection parameters.
 - To add a connection, select the Safety Slave that you want to add the connection to and click the **New** Button. Refer to *5-1-2 Setting Safety Connection Parameters* to set the parameters.
 - To delete a connection, select the connection you want to delete and click the **Delete** Button.
 - To edit connection parameters, select the connection you want to edit and click the **Edit** Button. The parameters of the selected connection will be displayed. Refer to *5-1-2 Setting Safety Connection Parameters* to change the parameters.
 - Select the Safety Slave and click the **Register/Unregister** Button. If connections are already set, the button cancels all the connections and if not, it allocates the default connection and parameters.

Note

- To delete a Safety Slave from the Register Device List, select the Safety Slave you want to delete and click the  Button.
- Also, when either of the following operations is performed in the Network Configuration Window, the Safety Slave will be registered using auto-allocation.
 - a. Dragging a slave device to the NE1A-series Controller.
 - b. Selecting a slave device and specifying the destination as the NE1A-series Controller by selecting Device and then *Register to Other Device* from the menu bar.

IMPORTANT Changing safety connection settings may affect the program. After changing any setting, always open the Logic Editor and check the program.

5-1-2 Setting Safety Connection Parameters

This section describes how to set safety connection parameters.

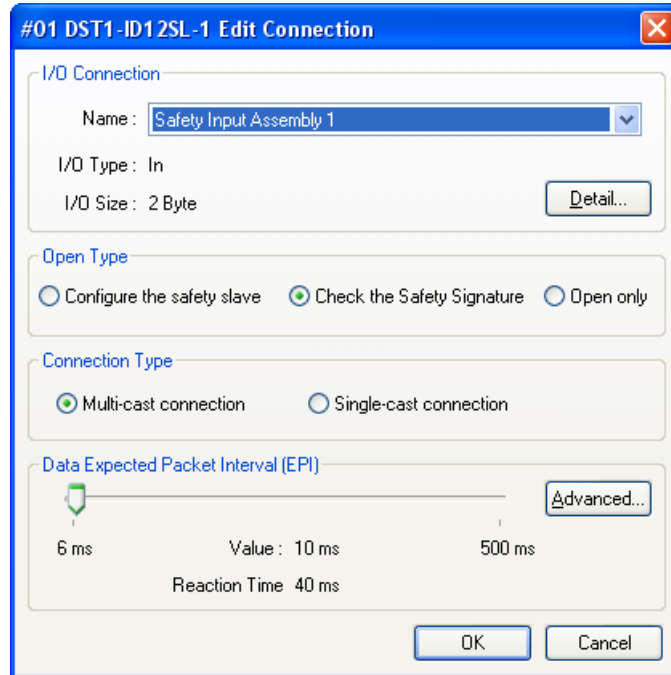

I/O Connections

Select the assembly to use from the I/O assemblies that the destination Safety Slave supports. Click the **Detail** Button to display detailed information on I/O assemblies.

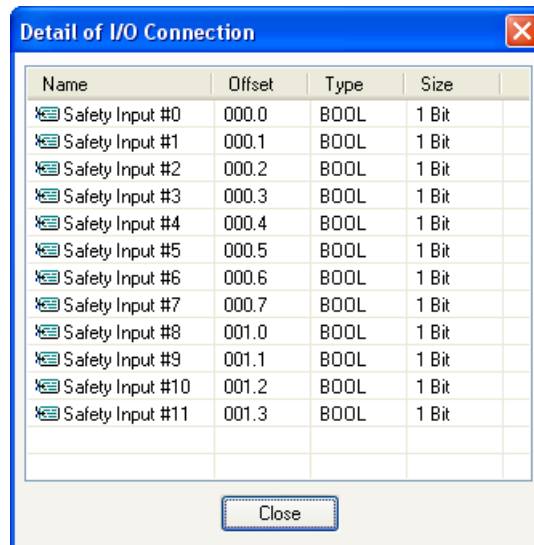

- Note**
- Refer to the DST1-Series *Safety I/O Terminals Operation Manual (3-2 Remote I/O Allocations)* for I/O assemblies that the DST1-series Safety I/O Terminals support.
 - When the Safety Slave function of the NE1A-series Controller is used, the I/O assembly must be set in the Safety Slave I/O Window. Refer to 5-2 *Safety Slave Settings*.

Output Connection Owner

To prevent safety outputs from an unintended Safety Master, the Safety Slave stores data in non-volatile memory to show that the Safety Master that last established an output connection (see note 1) is the owner of the output connection. The Safety Master data that is stored is the TUNID (see note 2). Other Safety Masters cannot open that output connection while the Safety Slave has an output connection owner TUNID stored.

If an attempt is made, the 7-segment display on the NE1A-series Safety Master will show “d6” and the status code (see note 3)(error code) shown on the Safety Connection Tab of the Device Monitor Window will be “01:0106”.

Reset the Safety Slave to the default settings to clear the output connection owner data.

- Note**
1. The DST1 is displayed as “Safety Output Assembly” and the NE1A-series Controller is displayed as “Safety Output.”
 2. Refer to 3-5-2 Network Numbers for information on TUNIDs.
 3. Refer to 7-1-2 Monitoring Safety Connections for information on status codes.

- Note**
- Reset the Safety Slave to default settings before opening an output connection from another Safety Master.
 - The error referred to earlier will occur if the Safety Master TUNID changes as a result of node address or network number changes and the output connection owner no longer matches.

Open Type

Select the type of open processing to be performed when the NE1A-series Controller establishes a connection with the Safety Slave.

Open Type	Description
Configure the Safety Slave	The Safety Slave is configured when the connection is established. The parameters that can be set are limited to the parameters relevant to the safety application. Do not use this open type under normal conditions.
Check the safety signature	The NE1A-series Controller sends the safety signature of the slave when the connection is established. The safety signature is checked in the Safety Slave that receives a connection is established. Specify this open type when establishing a connection with DST1-series Safety I/O Terminals.
Open only	The NE1A-series Controller does not send the safety signature of the slave when a connection is established. The Safety Slave establishes the connection without checking the safety signature. To use the slave function of the NE1A-series Controller, it is necessary to configure the Safety Slave correctly from the Network Configurator. If it is not correctly configured, a connection will not be established, so there is no need to send the safety signature from the Safety Master for checking.

IMPORTANT Check that the Safety Master and the Safety Slave are configured correctly when selecting *Open only* as the safety connection open type.

- Note**
- If the Safety Slave is not configured when *Configure the Safety Slave* is specified, the NE1A-series Controller configures the Safety Slave and then establishes a connection. Therefore, the communications can be started again just by connecting the slave to the network without the Network Configurator when the Safety Slave is replaced. In the current version, however, the parameters to be set are only those related to the safety application. When standard parameters do not need to be set, this open type can be specified. The ability to set standard parameters is planned for future development.

Configuration Owner

To prevent configuration from an unintended source, Safety Slaves store data in non-volatile memory to show that the node that performed configuration last time is the configuration owner. The Safety Slave stores data in memory to show if the configuration was performed by the Network Configurator or a similar software tool (see note 1) and, if the configuration was performed by a Safety Master, the Safety Slave stores the TUNID (see note 2). The Safety Slave cannot be configured from another source while it has data on the configuration owner.

If the configuration owner does not match, the following will occur.

- A) If a download is attempted using the Network Configurator, an error message will be displayed to indicate that configuration is not possible until the Safety Slave is reset because the Safety Slave has been configured by another device.
- B) If **Configure Target Device** is specified, the NE1A-series Safety Master 7-segment display will show “d6” and the status code (see note 3) (error code) shown on the Safety Connection Tab in the Monitor Device Window will be “01:0105”.
The configuration owner is cleared when the Safety Slave is reset to default settings.

- Note**
- (1) No distinction is made between Support Software, so other Network Configurators can be used to configure the Safety Slave.
 - (2) Refer to 3-5-2 *Network Numbers* for information on TUNIDs.
 - (3) Refer to 7-1-2 *Monitoring Safety Connections* for information on status codes.

- Note**
- **Reset the Safety Slave to default settings to configure from a different configuration owner.**
 - **The configuration owner will not match and the error listed above will occur if the Safety Master TUNID changes because the node address or network number has changed.**

Connection Type

Select the connection type to use between the NE1A-series Controller and Safety Slave.

Connection Type	Description
Multi-cast connection	<p>This connection type can be selected only with a Safety Input Slave. When a multi-cast connection is selected, a Safety Input Slave can transmit the input data to a maximum of 15 NE1A-series Controllers via a multi-cast connection.</p> <p>These NE1A-series Controllers are classified as the same multi-cast group when multiple NE1A-series Controllers establish a multi-cast connection with one Safety Slave and the I/O assembly and EPI values specified in I/O Connection are the same.</p> <p>This connection type can be selected even for one NE1A-series Controller.</p>
Single-cast connection	<p>This connection type can be selected for an input connection or output connection. The NE1A-series Controller and the Safety Slave establish a 1:1 connection and send safety data.</p>

EPI (Expected Packet Interval)

The EPI is the interval at which the Safety Controller and Safety Slave communicate safety data. The minimum set value is the greater of the destination Safety Slave cycle time and Safety Controller cycle time.

- a. The cycle time of DST1-series Safety Slaves is always 6 ms.

- b. The Safety Controller cycle time will be one of the following values if no default programming has been created.
- NE1A-SCPU01 (pre-version 1.0) and NE1A-SCPU01-V1 (with unit version 1.0 or 2.0): 4 ms
 - NE1A-SCPU02 (with unit version 1.0 or 2.0): 7 ms
 - NE1A-SCPU01-EIP: 8 ms
 - NE1A-SCPU02-EIP: 11 ms

The cycle time will be longer if safety logic programming has been created and will depend on the size of the programming. (Refer to the *11-2 Operational Flow and Cycle Times* in the *Safety Network Controller Operation Manual* (Cat. No. Z906-E1-07 or higher).

The Safety Controller cycle time can be checked under *Cycle Time* on the *Mode/Cycle Time* Tab in the *Edit Device Parameters* Dialog Box, once all parameters have been set and programming completed. (Refer to *5-6 Setting the Operating Mode and Confirming the Cycle Time.*)

The EPI set here affects the network bandwidth usage rate and the network reaction time.

- Network Reaction Time:

Displayed under *Reaction Time* in the *Data Expected Packet Interval (EPI)* Field. Refer to *2-3 Calculating and Verifying the Reaction Time* and *11-5 Reaction Time* in the *Safety Network Controller Operation Manual* (Cat. No. Z906-E1-07 or higher) for information on the network reaction time.

- Network Bandwidth Usage Rate:

Displayed at the bottom of the *Network Configuration* Window.

The network configuration may need to be reconsidered if the acceptable network bandwidth usage rate (must be 90% or less overall) cannot be obtained with the EPI setting required to achieve the required network reaction time. Refer to *2-2 Allocating Network Bandwidth Usage and Calculating the Best EPI* for details.

IMPORTANT Set the EPI for each safety connection longer than the Safety Network Controller cycle time. An error will occur when the safety connection parameters are downloaded if the EPI is shorter, and the download will fail.

Note Calculate the best average EPI for all connections using the following procedure and batch set the EPI to all devices.

1. Click the **Calculate EPI** Button for the Usage of Network Bandwidth at the bottom of the *Network Configuration* Window.
2. Input the network bandwidth to be used in the *Safety Connections* Field and click the **Calculate** Button.
3. The best average EPI for all connections will be displayed under *Best Average EPI*.
4. Click the **Update Device Configuration** Button.
5. Select the baud rate to be used in the *Update Device Configuration* Dialog Box and click the **OK** Button.

The best average EPI for all connections will be batch set as the EPI in the safety connection parameters for all devices.

Configurator version 1.6□ has an automatic EPI adjustment function. The EPI that is set in the device parameters is compared to the actual cycle time. If the EPI setting is shorter, it will be automatically updated. If the EPI is shorter than the device parameters, the following warning will be displayed.

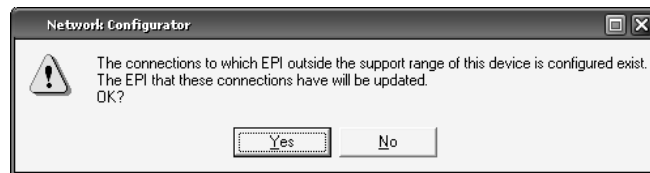

Click the **Yes** Button in the above dialog box. The EPI for the applicable connection will be automatically changed to the device cycle time.

It can prevent errors from occurring during downloads.

Note If the communications partner is an NE1A-series Controller in slave operation, the cycle time of the communications partner is not checked. Confirm that the EPI setting is greater than the cycle time of the communications partner.

Advanced Settings

The **Advanced** Button enables changing the settings of the following parameters. Normally it is not necessary to change the settings of these parameters.

Timeout Multiplier:

This parameter is used to set the number of timeouts used to determine if an error has occurred in communications. The default is two timeouts (i.e., only one timeout is allowed).

Network Delay Multiplier:

This parameter is used when calculating the reaction time. Set the network delay as a percentage of the EPI. The default is 100% (i.e., the same as the EPI).

ID Allocation:

This parameter is used to set whether the master or the slave will allocate an ID for the safety connection. Normally, this parameter is automatically set by the Network Configurator.

5-1-3 Stopping/Restarting Communications after an Error

With Ver. 1.0 and later Controllers (including NE1A-SCPU01-EIP and NE1A-SCPU02-EIP), the user can specify whether to stop or continue I/O communications after the connection times out during safety I/O communications with the safety slave. If I/O communications are stopped because of a timeout error, the communications can be restarted from the logic program or a Programming Device.

Setting the Operating Mode after a Communications Error

One of the following modes can be selected on the Extend Mode Tab Page to specify the Controller's operation when there is a connection timeout during safety I/O communications with the safety slave.

(For other settings refer to 5-7 *Extend Mode Settings*.)

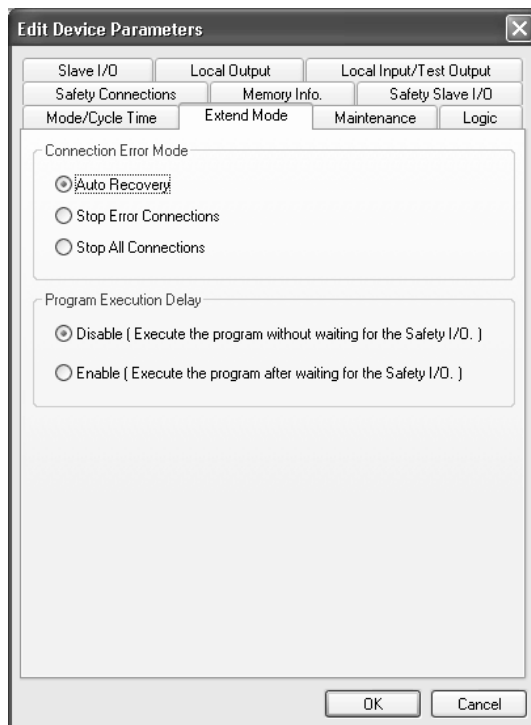

Mode after communications error	Description
Automatic reset	Specify this mode to re-establish the safety I/O connection with a safety slave after a safety I/O communications error has occurred with the slave. If the cause of the communications error is eliminated, safety I/O communications will restart automatically.

Mode after communications error	Description
<p>Stop only the connection where the error occurred.</p>	<p>Specify this mode to keep safety I/O communications with a safety slave stopped after a safety I/O communications error has occurred with the slave.</p> <p>To restart safety I/O communications with the safety slave after I/O communications have been stopped, use the Network Configurator to send a command to restart communications. It is also possible to write a logic routine in the logic program in advance to turn ON the Safety I/O Communications Restart Flag and restart communications with a specified trigger bit.</p>
<p>Stop all connections</p>	<p>Specify this mode to stop safety I/O communications with all safety slaves stopped after a safety I/O communications error has occurred.</p> <p>To restart safety I/O communications with the safety slaves after I/O communications have been stopped, use the Network Configurator to send a command to restart communications. It is also possible to write a logic routine in the logic program in advance to turn ON the Safety I/O Communications Restart Flag and restart communications with a specified trigger bit.</p> <p>This function is enabled when normal safety I/O communications are established with all Safety Slaves.</p>

5-1-4 Listing and Setting Connection Parameters

The connection data currently set for all devices can be displayed in the Edit All Connection Window and parameters can be changed. New connections, however, cannot be created and existing connections cannot be deleted.

Connection parameters can be efficiently changed from the Edit All Connection Window.

1. Select **Network – Edit All Connection**.
The Edit All Connection Window will be displayed.

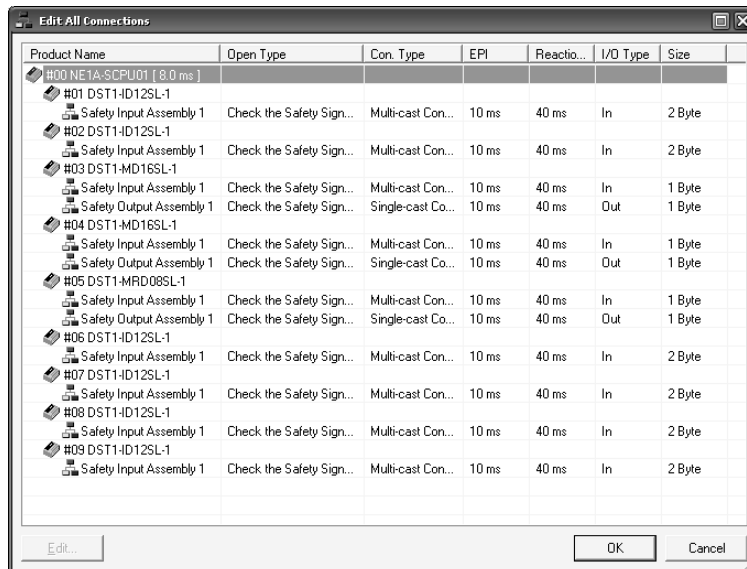

2. Double-click the connection in the list for which the settings are to be changed.
The Edit Connection Dialog Box will be displayed.

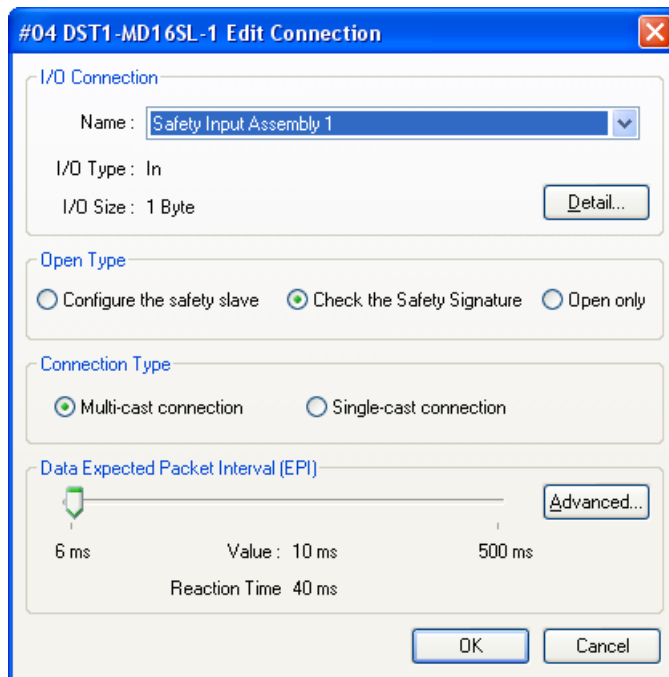

Refer to 5-1-2 *Setting Safety Connection Parameters* for information on how to use the Allocate Connections Dialog Box.

5-2 Safety Slave Settings

Clicking the **Safety I/O Target** Tab displays the setting window of the I/O assembly for the Safety Slave that is necessary to operate the NE1A-series Controller as a Safety Slave. The I/O assembly set here is displayed and can be selected in the Connection Setting Window of the NE1A-series Controller that is functioning as a Safety Master.

The I/O tags can be used in the Logic Editor.

Note When the NE1A-series Controller is not used as a Safety Slave, it is not necessary to set the parameters in this window.

5-2-1 Registering I/O Assemblies for Safety Slaves

Register the I/O assemblies for the Safety Slave to be used when the NE1A-series Controller functions as a Safety Slave.

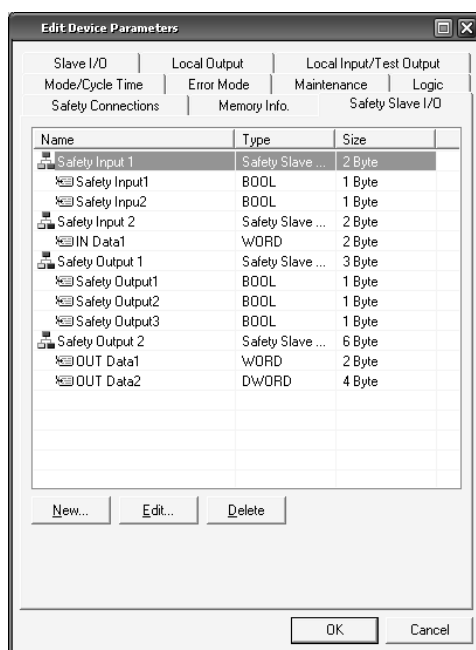

The following information is displayed in this window.

Item	Information Displayed
Name	The registered I/O assembly name (☐ icon) and the I/O tags name defined in the assembly (☒ icon) are displayed.
Type	The input/output type for the I/O assembly and the data types for the I/O tags are displayed.
Size	The I/O assembly size and the sizes of the I/O tags are displayed.

You can add, change, and delete I/O assemblies for the Safety Slave in this window. Up to four I/O assemblies can be registered.

- To add an I/O assembly, click the **New** Button. The I/O Assembly Setting Window will be displayed. Define the I/O assembly data referring to 5-2-2 *Setting Assembly Data*.
- To change the data of the I/O assembly, select the I/O assembly you want to change and click the **Edit** Button. The I/O Assembly Setting Window will be displayed. Change the I/O assembly data referring to 5-2-2 *Setting Assembly Data*.

- To delete the I/O assembly, select the I/O assembly you want to delete and click the **Delete** Button.

5-2-2 Setting Assembly Data

This section describes how to define I/O assembly data.

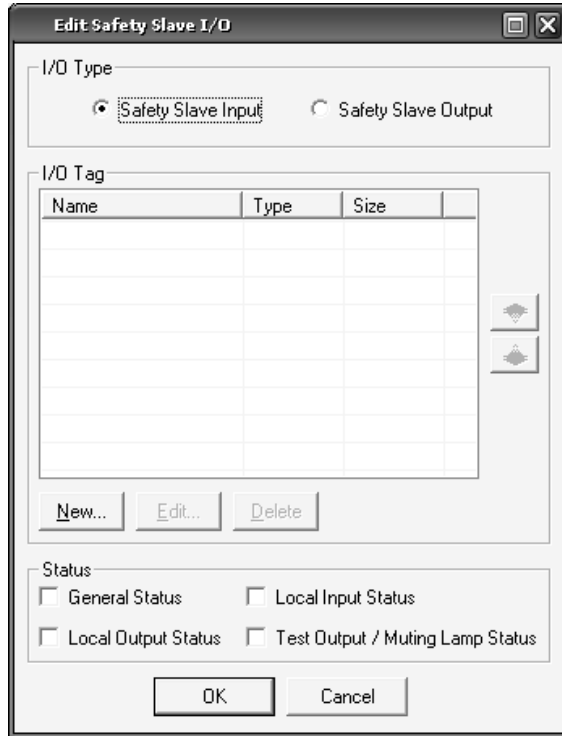

I/O Type

Select the data type to set. The transmission directions for the safety data are as follows:

- Safety Slave Input: NE1A-series Controller (Safety Slave) → Safety Master
- Safety Slave Output: Safety Master → NE1A-series Controller (Safety Slave)

I/O Tag

Multiple I/O tags can be defined in an I/O assembly. The I/O tags defined here can be used in the Logic Editor.

- Click the **New** Button and set a tag name and data type when defining a new I/O tag. I/O tags for up to 16 bytes can be defined in each I/O assembly.

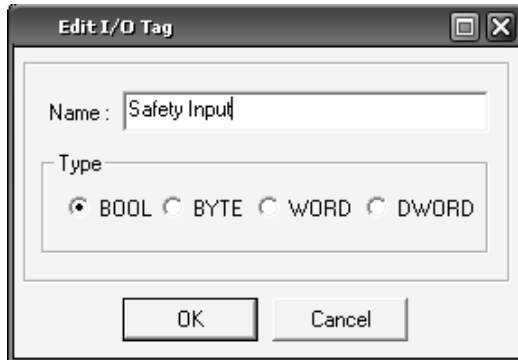

- To change an I/O tag that has already been defined, select the I/O tag you want to change and click the **Edit I/O Tag** Button.
- To delete an I/O tag that has already been defined, select the I/O tag you want to delete and click the **Delete** Button.

Note

- (1) BOOL (Boolean) data is 1 byte.
- (2) I/O tag names and I/O comments (names) cannot consist of only spaces.

Setting Tag Names by Bit

A tag can be set for each bit with an NE1A-series Controller with unit version 1.0 or higher (including NE1A-SCPU01-EIP and NE1A-SCPU02-EIP).

1. Select the applicable assembly in the I/O Assembly Setting Window.

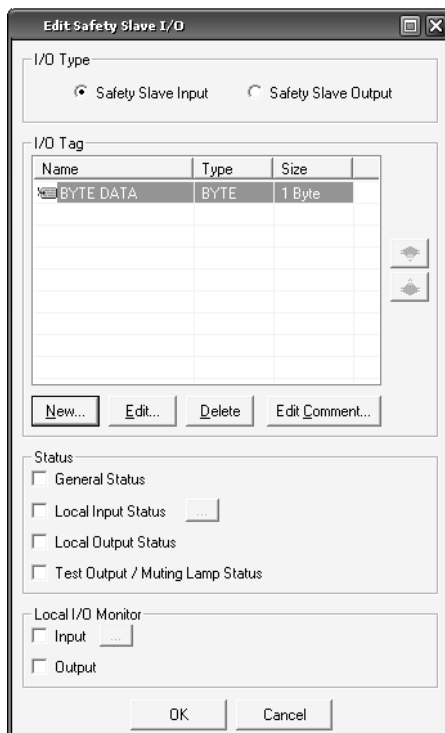

2. Click the **Edit Comment** Button.

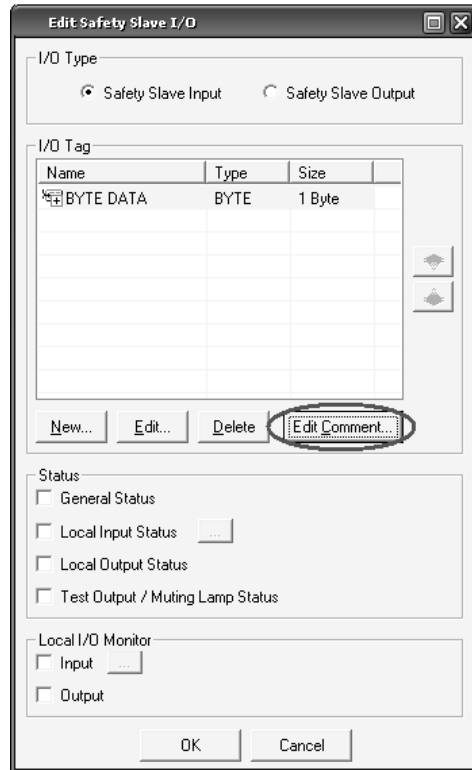

3. Edit the I/O Tag.

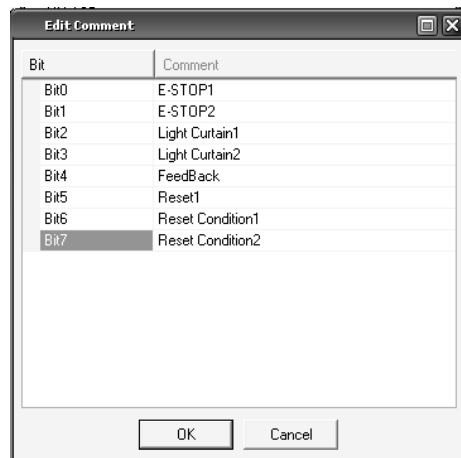

I/O Tags created in this way will be displayed as follows by the Logic Editor:

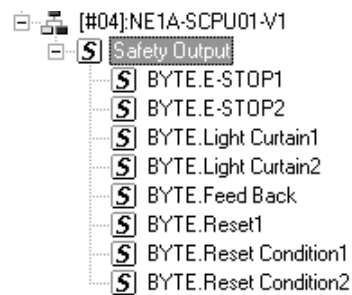

Status

When the I/O type is *Target Input*, the NE1A-series Controller status information can be included in the I/O assembly. The following tag names are automatically used for the status information:

Status	Tag name
General Status	General Status
Safety Input Status	Safety Input Status
Safety Output Status	Safety Output Status
Test Output/Muting Lamp Status	Test Output/Muting Lamp Status

Refer to 4-3-3 Remote I/O Area Data Configuration in the *DeviceNet Safety Network Controller Operation Manual* (Cat No. Z906).

Local I/O Monitor

When the I/O type is *Input*, the local I/O information of an NE1A-series Controller with unit version 1.0 or later (including NE1A-SCPU01-EIP and NE1A-SCPU02-EIP) can be included in the I/O assembly. Use the following procedure.

Check Box in the *Local I/O Monitor* Area.

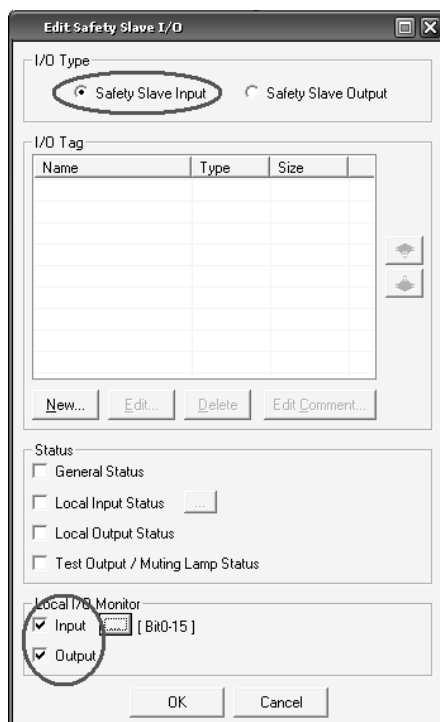

A button will be displayed next to the Input Check Box. The button will be labeled according to the number of input points ("Bit0-15" in the example display). Click this button. The following dialog box will be displayed.

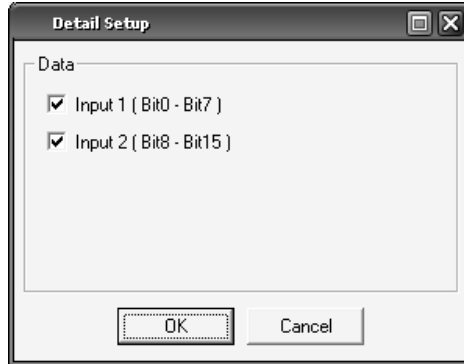

The check boxes that are displayed can be used to specify the data to include in the assembly data.

The local I/O data that has been specified to be included in the assembly data is displayed as shown below.

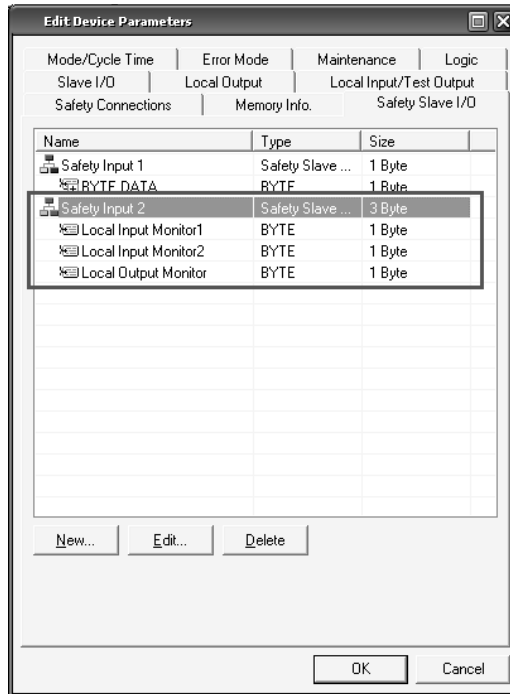

The local I/O data is displayed in the Program Window as shown below.

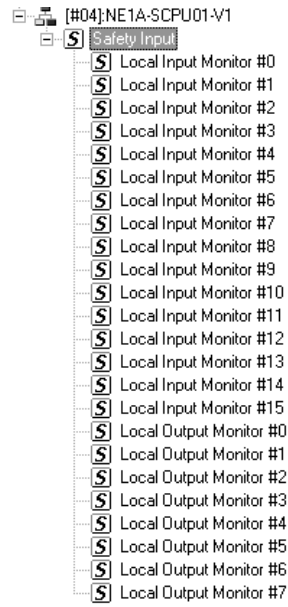

5-3 Standard Slave Settings

Clicking the **Slave I/O** Tab displays the window for setting a Standard Slave I/O assembly that is necessary for operating the NE1A-series Controller as a Standard Slave. The I/O assembly set here is displayed and can be selected in the Connection Setting Window of, for example, the DeviceNet Unit for a CS/CJ-series PLC that is a Standard Master.

The I/O tags defined in the I/O assembly can be used in the Logic Editor.



Note When the NE1A-series Controller is not used as a Standard Slave, it is not necessary to set the parameters in this window.

5-3-1 Registering I/O Assemblies for Standard Slaves

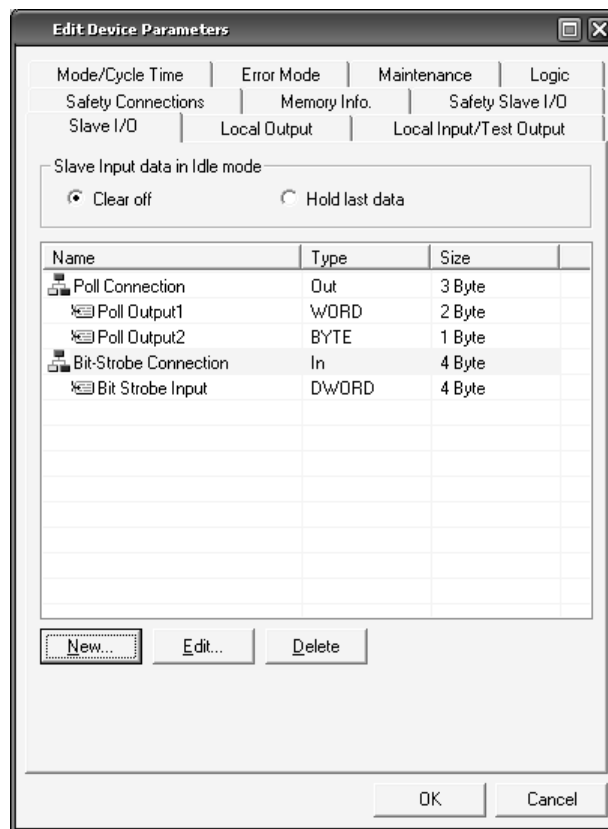
Register the I/O assemblies for the Standard Slave to be used when the NE1A-series Controller functions as a Standard Slave.



The following information is displayed in this window.

Item	Information Displayed
Name	The registered I/O assembly name () and I/O tags name defined in the assembly () are displayed.
Type	The input/output type for the I/O assembly and data types for the I/O tags are displayed.
Size	I/O assembly size and the sizes of I/O tags are displayed.

You can add, change, and delete I/O assemblies for a Standard Slave in this window. Input assemblies and output assemblies can be registered for each standard connection.

- To add an I/O assembly, click the **New** Button. The I/O Assembly Setting Window will be displayed. Refer to 5-3-3 *Setting Assembly Data* to define the I/O assembly data.
- To change the I/O assembly data, select the I/O assembly you want to change and click the **Edit** Button. The I/O Assembly Setting Window will be displayed. Refer to 5-3-3 *Setting Assembly Data* to define the I/O assembly data.
- To delete the I/O assembly, select the I/O assembly you want to delete and click the **Delete** Button.

5-3-2 Setting Slave Input Data in Idle State

Set to hold or clear the last data for an input assembly that the NE1A-series Controller transmits to the Standard Master in either of the following conditions:

- When changing the NE1A-series Controller from the RUN state to the IDLE state.
- When detecting an error, such as a communications error in a safety chain, that sets the data to an I/O tag in an input assembly.

5-3-3 Setting Assembly Data

This section describes how to define I/O assembly data.

The screenshot shows the 'Edit Slave I/O' dialog box. The 'I/O Type' section has 'Poll' selected. The 'I/O Tag' section has a table with columns 'Name', 'Type', and 'Size'. The 'Status' section has four checkboxes: 'General Status', 'Local Input Status', 'Local Output Status', and 'Test Output / Muting Lamp Status'. The 'OK' and 'Cancel' buttons are at the bottom.

I/O Type

Select the connection type to use for the I/O assembly. Input assemblies and output assemblies can be registered for each connection. Output assemblies cannot be registered, however, when *Bit-Strobe* is selected as the connection type, because the data cannot be output by the Standard Master.

I/O Tag

Multiple I/O tags can be defined in an I/O assembly. The I/O tags defined here can be used in the Logic Editor.

- Click the **New** Button and set a tag name and data type when defining a new I/O tag. I/O tags for up to 16 bytes can be defined in each I/O assembly. If *Bit-Strobe* is selected, however, the maximum is limited to 8 bytes.

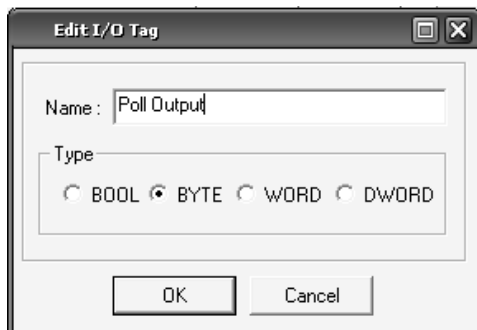

- To change an I/O tag that has already been defined, select the I/O tag you want to change and click the **Edit I/O Tag** Button.
- To delete an I/O tag that has already been defined, select the I/O tag you want to delete and click the **Delete** Button.

Note I/O tag names and I/O comments (names) cannot consist of only spaces.

Setting Bit Tags

With NE1A-series Controllers with unit version 1.0 or later (including NE1A-SCPU01-EIP and NE1A-SCPU02-EIP), tags can be set for each bit in the standard assembly, just as they can be for the safety assembly.

Status

When the I/O type is *Input*, the NE1A-series Controller status information can be included in the I/O assembly. The following tag names are automatically used for the status information:

Status	Tag Name
General Status	General Status
Safety Input Status	Safety Input Status
Safety Output Status	Safety Output Status
Test Output/Muting Lamp Status	Test Output/Muting Lamp Status

Local I/O Data

When the I/O type is *Input*, local I/O data for the NE1A-series Controller can be included in the I/O assembly, just as it can be in the safety I/O assembly.

5-4 Setting the Controller as an EtherNet/IP Standard Target

Click the EtherNet/IP Target I/O Tab to display the setting window for the Standard Target I/O assembly that is required to operate an NE1A-series Controller that supports EtherNet/IP as a standard target. The I/O assembly set here is displayed in and can be selected from the Connection Setting Window of Units such as CS/CJ-series EtherNet/IP Units (i.e., standard originators). In addition, the I/O tags can be used in the Logic Editor.

Set the Standard Target I/O assembly, and then set the communications for the EtherNet/IP originator.

For details on the setup method when connecting to an OMRON CS/CJ-series EtherNet/IP Communications Unit, refer to Appendix C Editing Parameters for CS/CJ-series EtherNet/IP Units.

Note When an NE1A-series Controller that supports EtherNet/IP is not used as a Standard Target, it is not necessary to make the settings in this window.

IMPORTANT When connecting to an OMRON CS/CJ-series EtherNet/IP Communications Unit, the EtherNet/IP I/O communications will be set in 2-byte units. Make the Standard Target settings in even numbers of bytes.

5-4-1 Registering I/O Assemblies for Standard Targets

Register the I/O assemblies for Standard Targets to be used when NE1A-series Controllers that support EtherNet/IP function as Standard Targets.

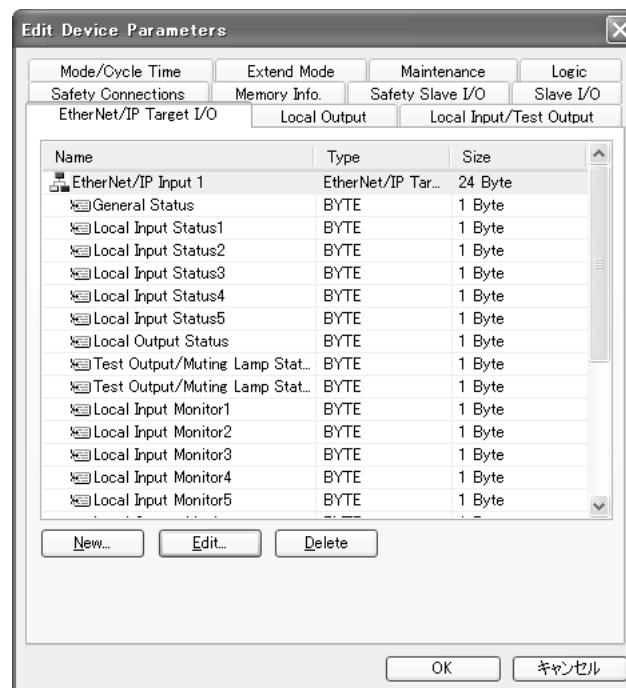

The following information is displayed in this window.

Item	Display
Name	The names of the registered I/O assembly (🏠 icon) and the I/O tags (🏠 icon) defined in the assembly are displayed.
Type	The I/O type of the I/O assembly and the data types for the I/O tags are displayed.
Size	The sizes of the I/O assembly and I/O tags are displayed.

You can add, change, or delete Standard Target I/O assemblies in this window. Input and output assemblies can be registered for each standard connection.

- To add an I/O assembly, click the **New** Button. The I/O Assembly Setting Window will be displayed. Define the I/O assembly data while referring to 5-3-3 Setting Assembly Data.
- To change the I/O assembly data, select the I/O assembly that you want to change and click the **Edit** Button. The I/O Assembly Setting Window will be displayed. Change the I/O assembly data while referring to 5-3-3 Setting Assembly Data.
- To delete the I/O assembly, select the I/O assembly that you want to delete and click the **Delete** Button.

5-4-2 Setting Assembly Data

This section describes how to define I/O assembly data.

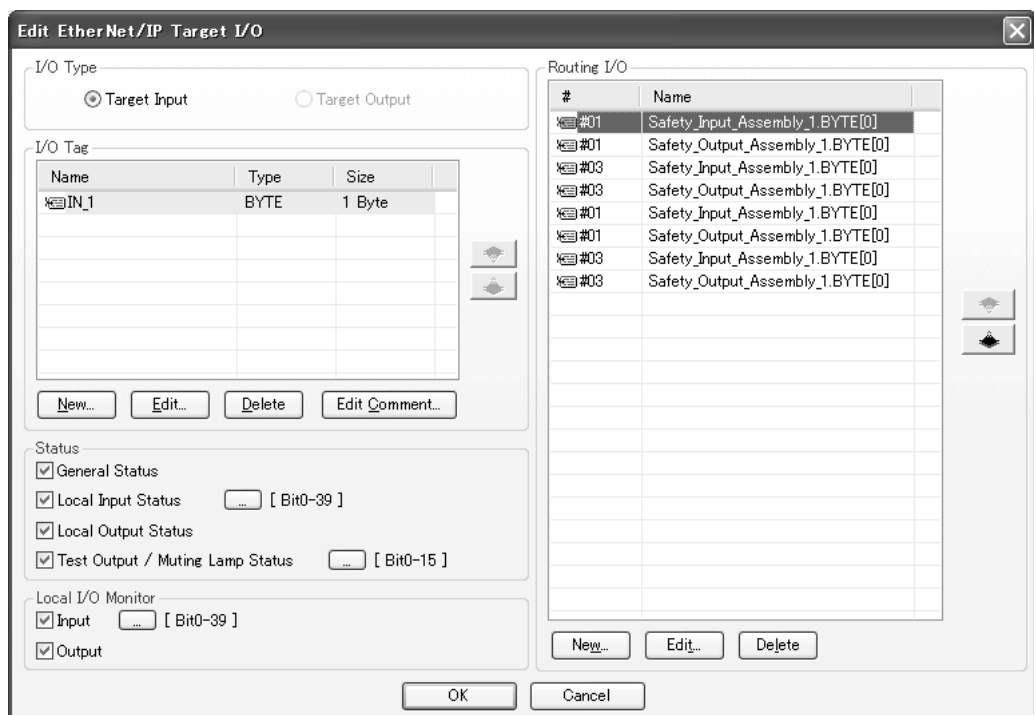

I/O Types

Select the connection type to be used for the I/O assembly. Input assemblies and output assemblies can be set for each connection.

I/O Tags

Multiple I/O tags can be defined in an I/O assembly. The I/O tags defined here can be used by the Logic Editor.

- To define a new I/O tag, click the **New** Button and set the tag name and data type. I/O tags for up to 16 bytes can be defined in each I/O assembly.

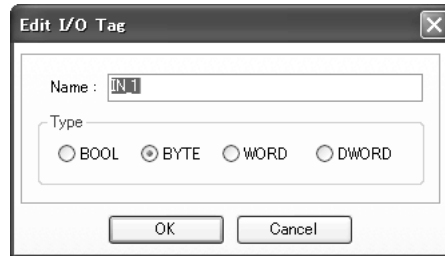

- To change an I/O tag that has already been defined, select the I/O tag that you want to change and click the **Edit** Button.
- To delete an I/O tag that has already been defined, select the I/O tag that you want to delete and click the **Delete** Button.

Note I/O tag names and I/O comment names cannot consist of only spaces.

Setting Bit Tags

With NE1A-series Controllers with unit version 1.0 or later (including NE1A-SCPU01-EIP and NE1A-SCPU02-EIP), tags can be set for each bit in the standard assembly just as they can be for the safety assembly.

Status

When the I/O type is *Input*, the NE1A-series Controller status information can be included in the I/O assembly. The following tag names are automatically used for the status information.

Status	Tag name
General status	General Status
Local input status	Local Input Status
Local output status	Local Output Status
Test output/muting lamp status	Test Output/Muting Lamp Status

Local I/O Data

When the I/O type is *Input*, the NE1A-series Controller local I/O information can be included in the I/O assembly just as it can be for the safety I/O assembly.

Routing I/O

When the I/O type is *Input*, I/O information set for safety connections using DeviceNet Safety can be included in the I/O assembly.

- To define new routing I/O, click the **New** Button and select the applicable connection information.

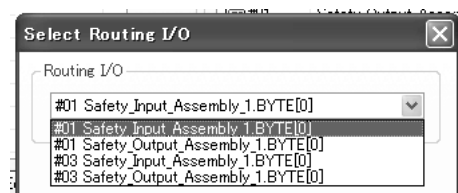

- To change an I/O tag that has already been defined, select the I/O tag that you want to change and click the **Edit** Button.
- To delete an I/O tag that has already been defined, select the I/O tag that you want to delete and click the **Delete** Button.

5-5 Local I/O Settings

Click the **Local OUT** Tab or **Local IN/Test Output** Tab to display the NE1A-series Controller's I/O Setting Window.

- Note**
- (1) All I/O are in the *Not Used* state in the default settings. If you do not use the I/O of the NE1A-series Controller, it is not necessary to set the parameters in this window.
 - (2) With Network Configurator version 2.0□ or higher, standard parameters can be set using a wizard. Errors in parameter settings can be reduced by using the wizard.

5-5-1 Setting Parameters Using the Wizard

With Configurator Ver. 2.0□ or higher, I/O parameters for NE1A-series Controllers can be set using a wizard. This section explains the procedure.

1. Select a NE1A-series Controller, and then select **Device - Parameter - Wizard**. The following window will be displayed.

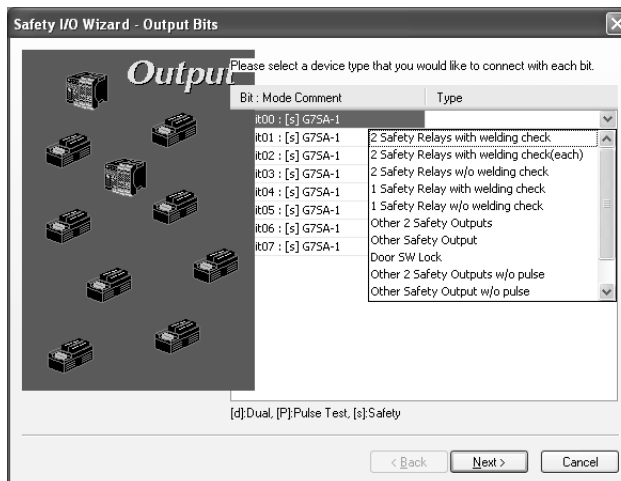

2. In the window above, specify the type of device to be connected to each terminal. The following types can be specified.

Type	Description
2 Safety Relays with welding check	Specify to connect to two Safety Relay outputs (with welding check for each).
2 Safety Relays w/o welding check	Specify to connect to two Safety Relay outputs (with no welding check).
1 Safety Relay with welding check	Specify to connect to one Safety Relay output (with welding check).
1 Safety Relay w/o welding check	Specify to connect to one Safety Relay output (with no welding check).
Other 2 Safety Outputs	Specify to connect to two outputs without welding check.
Other Safety Output	Specify to connect to one output without welding check.
Door SW Lock	Specify to connect to an electromagnetic door switch.
2 Safety Outputs w/o pulse check	Specify to connect to two outputs that do not require pulse to be checked.
1 Safety Output w/o pulse check	Specify to connect to one output that does not require pulse to be checked.

Type	Description
Other Standard Output	Specify to use the output for non-safety applications.
Not Use	Specify to not use the output.

Note Can be selected only when the terminal number is an even number.

- The following dialog box will be displayed if a type with welding check is selected when the terminal is set.

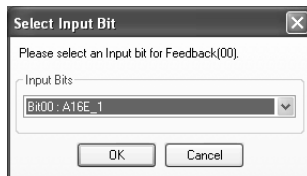

- In this dialog box, select the input for which welding is to be checked, and then click the OK Button.

3. Click the **Next** Button.
The window for setting input terminals will be displayed.

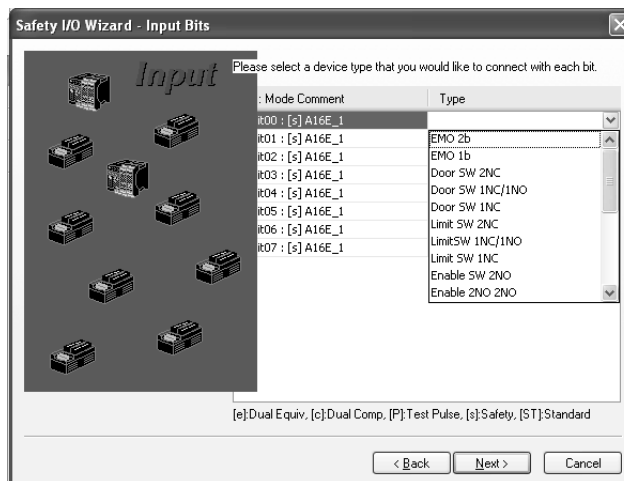

4. In the above window, specify the type of device to be connected to each terminal. The following types can be specified.

Type	Description
EMO 2b (DPST-NC, see note 1.)	Specify to connect two inputs from an emergency OFF button.
EMO 1b (SPST-NC)	Specify to use one input from an emergency OFF button.
Door SW 2NC (See note 1.)	Specify to use two inputs (NC) from a door switch.
Door SW 1NC/1NO (See note 1.)	Specify to use two inputs (NC and NO) from a door switch.
Door SW 1NC	Specify to use one input from a door switch.
Limit SW 2NC (See note 1.)	Specify to use two inputs (both NC) from a limit switch.
Limit SW 1NC/1NO (See note 1.)	Specify to use two inputs (NC and NO) from a limit switch.
Limit SW 1NC	Specify to use one input from a limit switch.
Enable SW 2NO (See note 1.)	Specify to use two inputs from an enable switch.
Enable 2NO/1NC/1NC (See note 2.)	Specify to use four inputs from an enable switch.
Two Hand Switch (See note 1.)	Specify to use two inputs from a two hand switch.
Other 2NC (See note 1.)	Specify to use two inputs from other 2-NC devices.
Other 2NO (See note 1.)	Specify to use two inputs from other 2-NO devices.
Other 1NC/1NO (See note 1.)	Specify to use two inputs from other NC/NO devices.

Type	Description
Other 1NO/1NC (See note 1.)	Specify to use two inputs form other NO/NC devices.
Single Contact	Specify to use one input from other devices.
SLC 2 outputs (See note 1.)	Specify to use two inputs from a light curtain.
SLC 1 output	Specify to use one input from a light curtain.
Other PNP 2 outputs (See note 1.)	Specify to use two inputs from other semiconductors.
Other PNP output	Specify to use one input from other semiconductors.
Reset SW	Specify to use input from a reset switch.
Welding Check (EDM input)	Specify to use as EDM feedback signal.
Standard SW	Specify to use inputs from a switch for non-safety applications.
Not Use	Specify to not use the input.

- Note**
- (1) Can be selected only when the terminal number is an even number.
 - (2) Can be selected only when the terminal number is an even number and there are at least four remaining terminals.
5. Click the **Next** Button. The following dialog box will be displayed.

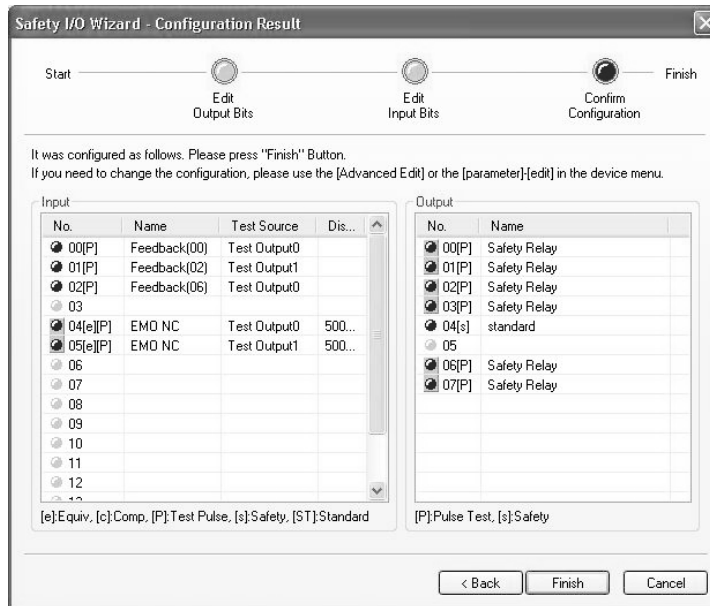

6. Check the settings and then click the **Finish** Button.

Setting I/O Terminal Comments

In the window for setting input and output terminals, click the **Edit I/O Comments** Button. The following dialog box will be displayed.

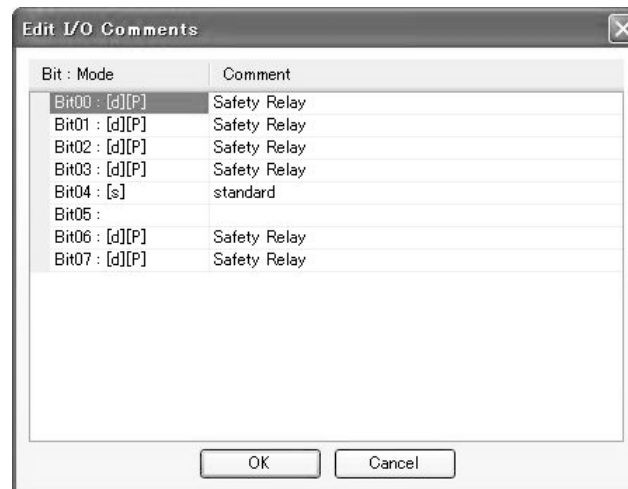

The comments for the I/O terminals can be edited in this dialog box.

5-5-2 Setting Safety Inputs

Click the **Local IN/Test Output** Tab and then click the **General** Tab in the window. To configure the safety inputs.

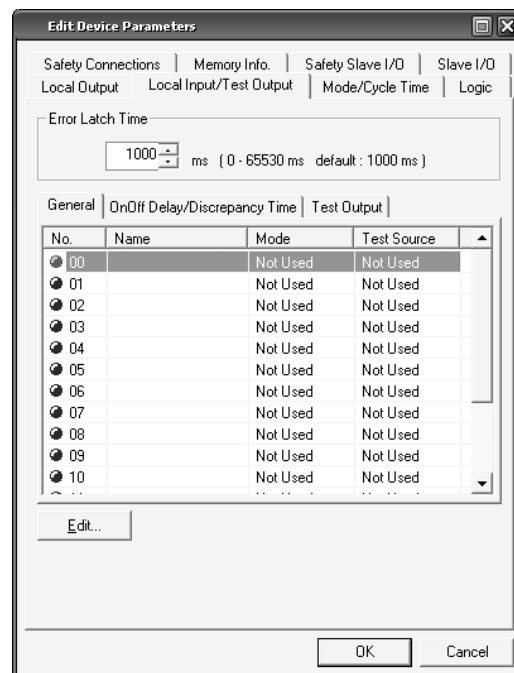

Note There are many settings for safety inputs. The display window is thus separated into the **General** Tab Page and **On-Off Delay/Discrepancy Time** Tab Page. Safety input scan are set from both tab pages.

Error Latch Time

This parameter applies to all safety inputs and test outputs. It sets the time to latch the error state when an error occurs in an input or output.

Even if cause of the cause of the error has been removed, the error state is always latched for this time. It can be set between 0 and 65,530 ms in 10-ms increments.

Settings for Individual Safety Inputs

Double-click the row of the safety input to set or select the row and click the **Edit** Button.

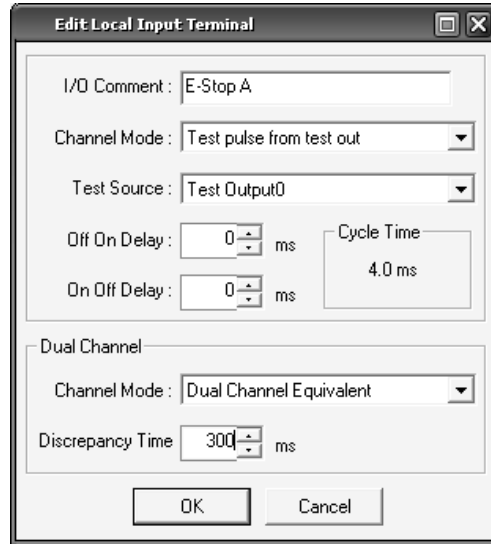

Terminal Name

A terminal name can be set for a safety input. The terminal name set here is used as the I/O tag in the Logic Editor.

Channel Mode

Set the Channel Mode for the safety input.

Channel Mode	Description
Not Used	The corresponding safety input will not be used. (It does not connect to an external input device.)
Test pulse from test out	Specifies connecting a device with a contact output in combination with a test output. When this mode is selected, select the test output to use for the <i>Test Source</i> and then set the test output mode to <i>Pulse Test Output</i> . When these settings are made, contact between the input signal line and the power supply (plus) and short circuits with other input signal lines can be detected.
Used as safety input	Specifies connecting a safety device with a semiconductor output, such as a light curtain.
Used as standard input	Specifies connecting a standard device (i.e., a non-safety device).

Test Source

When the channel mode of a safety input is set to *Test pulse from test out*, select the test output to use in combination with the safety input.

The channel mode for the test output selected here is automatically set to *Pulse Test Output*.

Note The channel mode of the test output selected here automatically becomes *Pulse Test Output*.

ON Delay Time and OFF Delay Time

These parameters set the ON delay time and OFF delay time for the safety input. The setting range is 0 to 128 ms, but it must be a multiple of the NE1A-series Controller cycle time. Check the displayed NE1A-series Controller cycle time and determine the set value.

IMPORTANT

- The optimum value for the NE1A-series Controller cycle time is automatically calculated based on the parameter settings and the programs. Therefore, the ON delay time and OFF delay time must be set last.
- Set integral multiples of the cycle time for the ON delay time and OFF delay time. Otherwise, an error will be displayed when the Edit Device Parameters Window is closed.
- Automatic adjustment of ON and OFF delay times can be used with Network Configurator version 1.6□ or higher, as described below.

Automatic Adjustment of ON and OFF Delay Times

If parameters that affect the cycle time are changed after the ON and OFF delays have been set, it may become impossible to close the Edit Device Parameters Dialog Box due to an error in the parameter settings. If this occurs, the ON and OFF delay times can be readjusted based on the cycle time.

As shown in the illustration below, there is a button on the **Local Input/Test Output** Tab Page for adjusting the effective ON/OFF delay time based on the cycle time. Pressing this button sets all values to be automatically adjusted as a multiple of the cycle time.

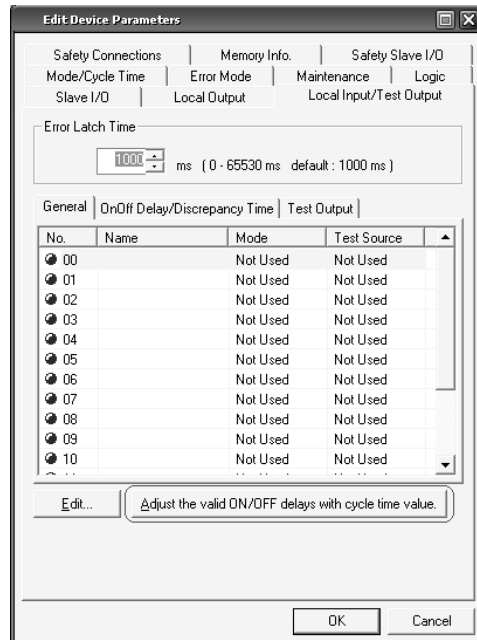

Dual Channel Safety Input Mode

Set the Dual Channel Safety Input Mode and the discrepancy time. The combinations that can be used in Dual Channel Mode are pre-defined.

The discrepancy time can be set between 0 and 65,530 ms in 10-ms increments.

Channel Mode	Description
Single Channel	Specifies using Single Channel Mode. If <i>Single Channel</i> is selected, the Safety Input Terminal to be paired in the Dual Channel setting will also be set to Single Channel Mode.
Dual Channel Equivalent	Specifies using the Dual Channel Equivalent Mode with a paired Safety Input Terminal.
Dual Channel Complementary	Specifies using the Dual Channel Complementary Mode with a paired Safety Input Terminal.

5-5-3 Setting Test Outputs

Click the **Local IN/Test Output** Tab and then **Test Output** Tab in the window to set the test outputs.

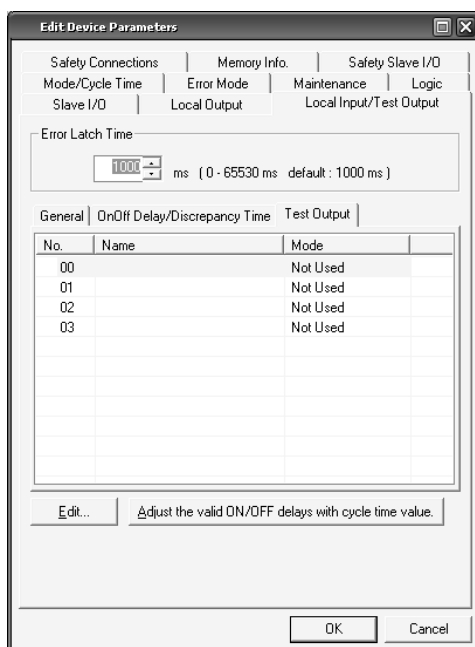

Error Latch Time

The test output is used in combination with a safety input. The same error latch time setting is thus used for all safety inputs. Refer to *Error Latch Time* in 5-5-2 *Setting Safety Inputs*.

Settings for Individual Test Outputs

Double-click the row of the test output number to set, or select the row and click the **Edit** Button.

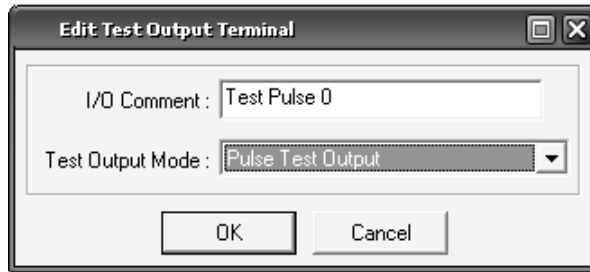

Terminal Name

Set the terminal name for the test output. The terminal name set here is used as the I/O tag in the Logic Editor.

Test Output Mode

Set the Channel Mode for the test output.

Channel Mode	Description
Not Used	The corresponding Test Output is not used.
Standard Output	Specifies connecting to the input for a muting lamp or PLC. Used as a Monitor Output.
Pulse Test Output	Specifies connecting a device with a contact output in combination with a safety input.
Muting Lamp Output	Specifies a muting lamp output. (Setting supported only for T3 Terminal.) When the output is ON, disconnection of the muting lamp can be detected.

Note I/O tag names and I/O comments (names) cannot consist of only spaces.

5-5-4 Setting Safety Outputs

Click the **Local OUT** Tab to set the safety outputs.

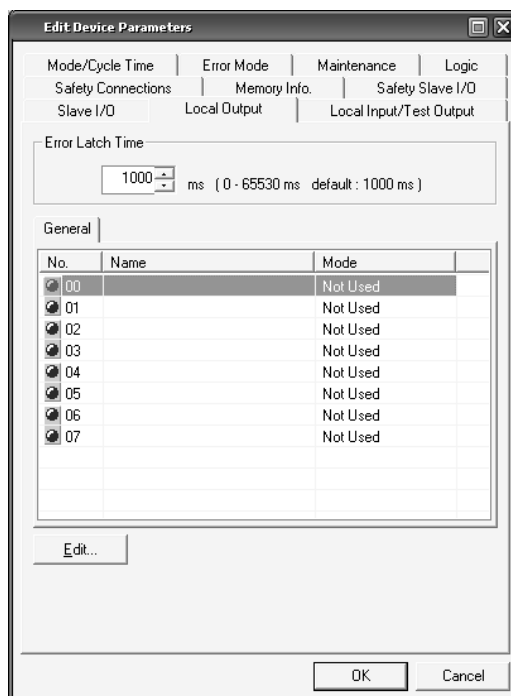

Error Latch Time

This parameter applies to all the safety outputs. It sets the time to latch the error state if an error occurs in a safety output.

Even if the cause of the error is removed, the error state will be latched for the time set here. It can be set between 0 and 65,530 ms in 10-ms increments.

Settings for Individual Safety Outputs

Double-click the row of the safety output number to set, or select the row and click the **Edit** Button.

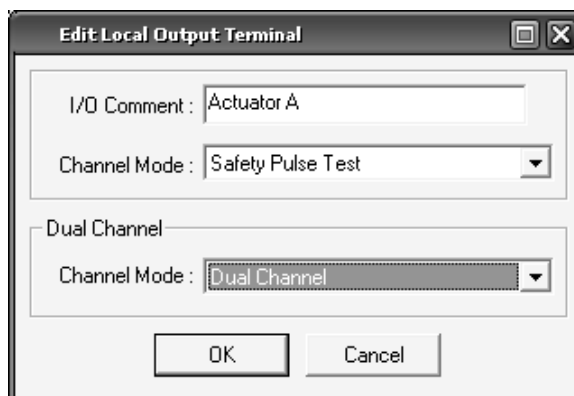

Terminal Name

Set a terminal name for a safety output. The terminal name set here is used as the I/O tag in the Logic Editor.

Safety Output Channel Mode

Set the Channel Mode for the safety output.

Channel Mode	Description
Not Used	The Safety Output Terminal is not used. (External output device not connected.)
Safety	Specifies not outputting the test pulse when the output is ON. Contact between the output signal line and the power supply (positive) when the output is OFF and ground faults can be detected.
Safety Pulse Test	Outputs the test pulse when the output is ON. Contact between the output signal line and the power supply, and short circuits with other output signal lines can be detected.

Dual Channel Safety Output Mode

Set the Dual Channel Safety Output Mode. The combinations that can be used in the Dual Channel Mode are pre-defined.

Channel Mode	Description
Single Channel	Specifies using Single Channel Mode. When <i>Single Channel</i> is set, the Safety Output to be paired in the Dual Channel Mode is also set to Single Channel Mode.
Dual Channel	Specifies using Dual Channel Mode. When both of the Safety Outputs to be paired are normal, the outputs can be turned ON.

Note I/O tag names and I/O comments (names) cannot consist of only spaces.

5-6 Setting the Operating Mode and Confirming the Cycle Time

Click the **Mode/Cycle Time** Tab to display the NE1A-series Controller operating mode settings and the cycle time.

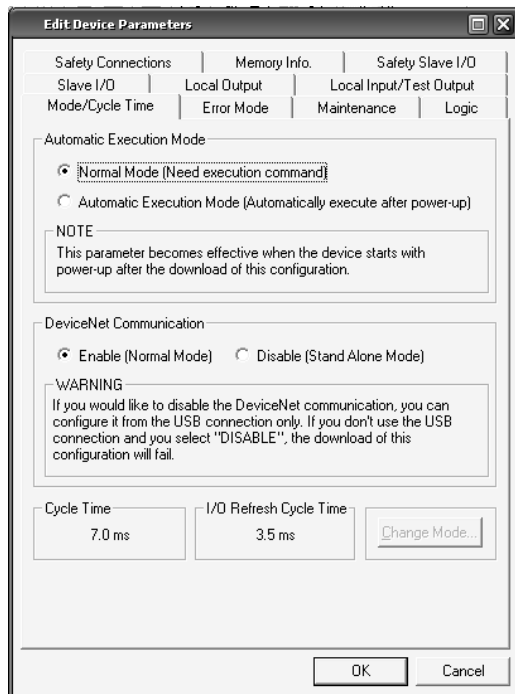

5-6-1 Setting the NE1A-series Controller Operating Mode

Automatic Execution Mode

Set the NE1A-series Controller automatic execution mode only after the system has been configured (i.e., after downloading device parameters).

Automatic Execution Mode	Description
Normal Mode	The Controller starts in IDLE Mode after the power supply is turned ON. To change to RUN Mode, the operating mode must be changed from the Network Configurator. Use this mode until device parameters have been verified.
Automatic Execution Mode	If this mode is selected and the following conditions exist, the Controller will start in RUN Mode after the power supply is turned ON: <ul style="list-style-type: none"> • The configuration has been locked. • The operating mode before the power was turned OFF was RUN Mode.

IMPORTANT Even when Automatic Execution Mode is selected and the configuration has been locked, the next startup will not be performed in RUN Mode if the power is turned OFF in IDLE Mode. Turn OFF the power in RUN Mode to use automatic execution.

Setting DeviceNet Communications

Disabling DeviceNet communications (Standalone Mode) shortens the NE1A-series Controller cycle time. If you disable DeviceNet communications, you will no longer be able to use any of the DeviceNet communications functions.

- IMPORTANT** • When disabling DeviceNet communications, connect the Network Configurator via the NE1A-series Controller's USB port. If the parameters that disabled DeviceNet communications are downloaded while connected via a DeviceNet Interface Card, an error will occur in the Network Configurator because the DeviceNet communications of the NE1A-series Controller will stopped.
- With NE1A-series Controllers that support EtherNet/IP, it is possible to connect via EtherNet/IP.

5-6-2 Confirming the Cycle Time

Cycle Time

The NE1A-series Controller cycle time is automatically calculated and displayed based on the set parameters and programs created in the Logic Editor. The cycle time is used in calculating the reaction time and the ON/OFF delay time settings. Check the value after all the parameters and programs have been set.

I/O Refresh Cycle

The I/O refresh cycle is used to refresh local I/O. It is automatically calculated with the cycle time and displayed.

The I/O refresh cycle time is used in calculating the reaction time.

Check the value after all the parameters and programs have been set.

5-6-3 Restarting a Connection Stopped due to a Communications Error

When I/O communications have stopped in a connection due to a connection timeout, I/O communications can be restarted in the stopped connection by turning ON the Communications Restart Flag from the logic program or sending a Communications Restart command from the Network Configurator. If the Controller communications mode is set to stop all connections after a communications error, communications cannot be restarted in a specified stopped connection. In this case, restart communications in all connections.

1. Restarting I/O Communications from the Network Configurator

After connecting online with the Network Configurator, select the Safety Master, right-click to display the popup menu, and select **Monitor** to display the Monitor Device Window. The following window will appear when the safety connection is selected.

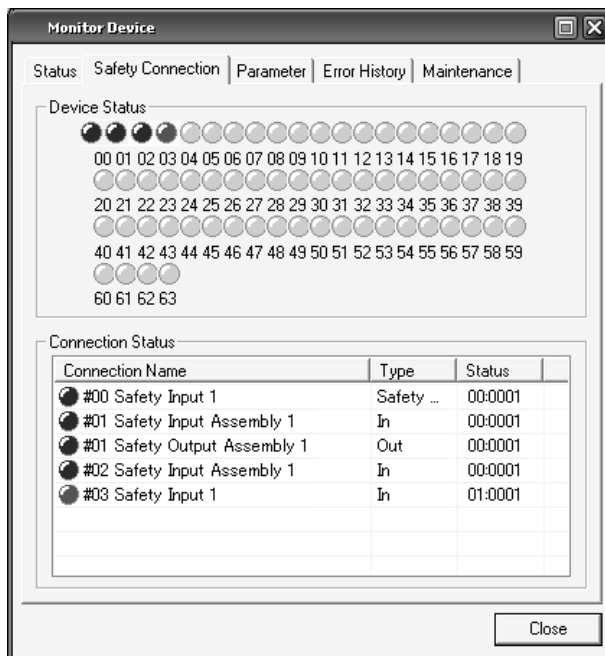

Communications can be restarted in a connection where an error occurred (evident from the connection status) by selecting that connection and clicking the **Resume** Button. If the **Resume All** Button is clicked, I/O communications will restart in all Slaves with which communications were stopped. Retries will be made until communications are restarted.

2. Restarting I/O Communications from the Logic Program
 When the safety connection is set, the following logic program output tags will be displayed for the connection.

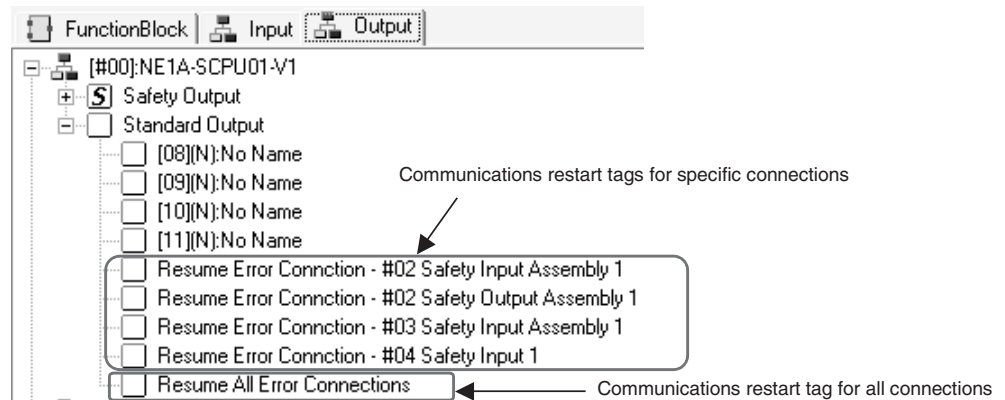

When these tags have been set in the logic program in advance as I/O communications restart conditions, I/O communications can be restarted with these tags by turning ON (OFF → ON) the specified condition.

5-7 Extend Mode Settings

The Extend Mode settings can be set when using the NE1A-SCPU01-V1 or NE1A-SCPU02 Controllers (including NE1A-SCPU01-EIP and NE1A-SCPU02-EIP). The Extend Mode Tab Page includes the Connection Error Mode and Program Execution Delay. The Program Execution Delay can be set only when using version 2.0 or higher (including NE1A-SCPU01-EIP and NE1A-SCPU02-EIP).

5-7-1 Setting the Operating Mode after a Communications Error

An operating mode can be selected on the Extend Mode Tab Page of the Edit Device Parameters Dialog Box to specify the Controller's operation when there is a connection timeout during safety I/O communications with a safety slave.

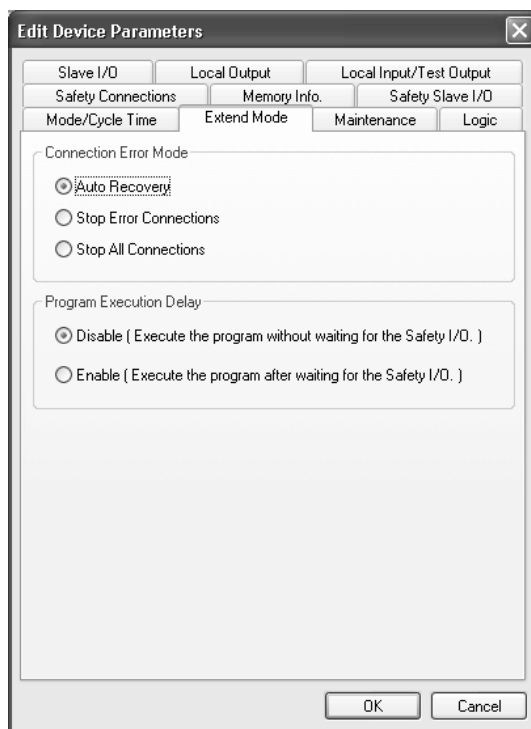

Connection error mode	Description
Automatic Recovery	Specify this mode to re-establish the safety I/O connection with a Safety Slave after a safety I/O communications error has occurred with the Slave. If the cause of the communications error is eliminated, safety I/O communications will restart automatically.
Stop Error Connections	Specify this mode to keep safety I/O communications with a safety slave stopped after a safety I/O communications error has occurred with the slave. To restart safety I/O communications with the safety slave after I/O communications have been stopped, use the Network Configurator to send a command to restart communications. It is also possible to write a logic routine in the logic program in advance to turn ON the Safety I/O Communications Restart Flag and restart communications with a specified trigger.
Stop All Connections	Specify this mode to stop safety I/O communications with all safety slaves stopped after a safety I/O communications error has occurred. To restart safety I/O communications with the safety slaves after I/O communications have been stopped, use the Network Configurator to send a command to restart communications. It is also possible to write a logic routine in the logic program in advance to turn ON the Safety I/O Communications Restart Flag and restart communications with a specified trigger. This function is enabled when safety I/O communications are normally established with all Safety Slaves.

5-7-2 Setting the Program Execution Delay

Program Execution Delay	Description
Disable (Execute the program without waiting for the Safety I/O.)	The program will be executed without waiting for communications to begin. The Slave input signals will not be updated in the program until communications begins. (Input values will be 0.) Program operation results will not be output to the Slaves.
Enable (Execute the program after waiting for the Safety I/O.)	Executes the program after waiting for all safety I/O communications to begin. Program execution is delayed in comparison to when Disable is selected. If communications never begins, the program will be executed but the Slave input signals will not be updated in the program. (Input values will be 0.)

Note When the Program Execution Delay is disabled, the Slave input signals will not be updated in the program until communications begins. (Input values will be 0.) Because of this, errors will occur in programs that use a Slave input as the feedback signal to the EDM, or as the input to a function block with dual channel equivalent inputs. If this happens, enable the Program Execution Delay.

5-8 Setting Maintenance Information

The Maintenance Information can be set when using the NE1A-SCPU01-V1 or NE1A-SCPU02 Controller (including NE1A-SCPU01-EIP and NE1A-SCPU02-EIP). For details, refer to *7-2 Maintenance Functions (Unit Version 1.0 or Later)*.

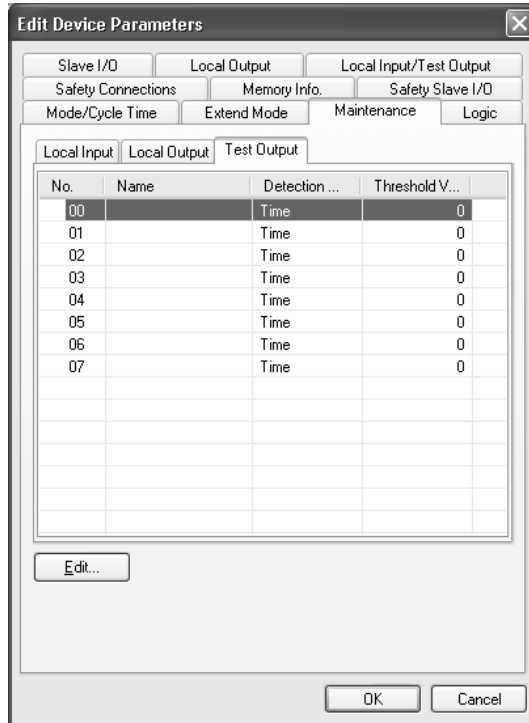

5-9 Displaying Memory Information

Information about the memory allocated to the NE1A-series Controller can be displayed by clicking the **Memory Info.** Tab in the Edit Device Parameter Dialog Box.

Users do not normally need to be aware of the memory addresses because the Network Configurator automatically sets them.

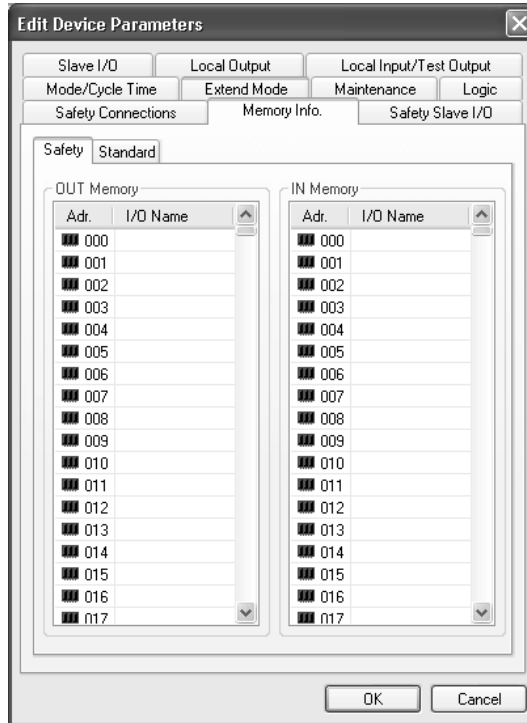

SECTION 6

Programming the Safety Network Controller

6-1	Starting and Exiting the Logic Editor	174
6-1-1	Starting the Logic Editor	174
6-1-2	Exiting the Logic Editor	175
6-2	Menu Commands	176
6-2-1	File Menu	176
6-2-2	Edit Menu	176
6-2-3	View Menu	177
6-2-4	Function Menu	177
6-2-5	Page Menu	177
6-2-6	Function Block Menu	178
6-3	Programming.	179
6-3-1	Workspace.	179
6-3-2	Function Blocks	180
6-3-3	Programming Using Function Blocks	183
6-3-4	Programming User-defined Function Blocks	197
6-3-5	Password Protection for User-defined Function Blocks.	210
6-3-6	Saving the Program.	211
6-3-7	Password Protection for Programs	212
6-3-8	Updating the Program.	213
6-3-9	Monitoring the Program	213

6-1 Starting and Exiting the Logic Editor

6-1-1 Starting the Logic Editor

Use the Logic Editor to program the NE1A-series Controller.

Use the following procedure to start the Logic Editor.

1. Click the **Logic** Tab in the Edit Device Parameters Window of the NE1A-series Controller.

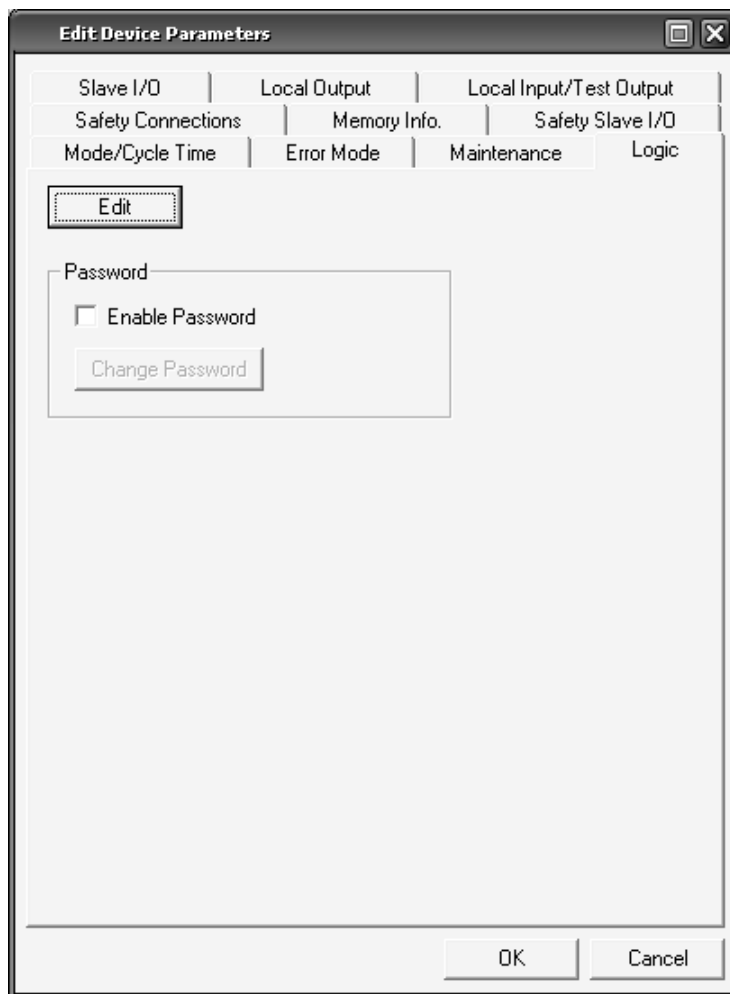

2. Click the **Edit** Button.

The Logic Editor will start, as shown in the following figure.

The Logic Editor consists of the Object List and the Workspace, as shown in the following figure.

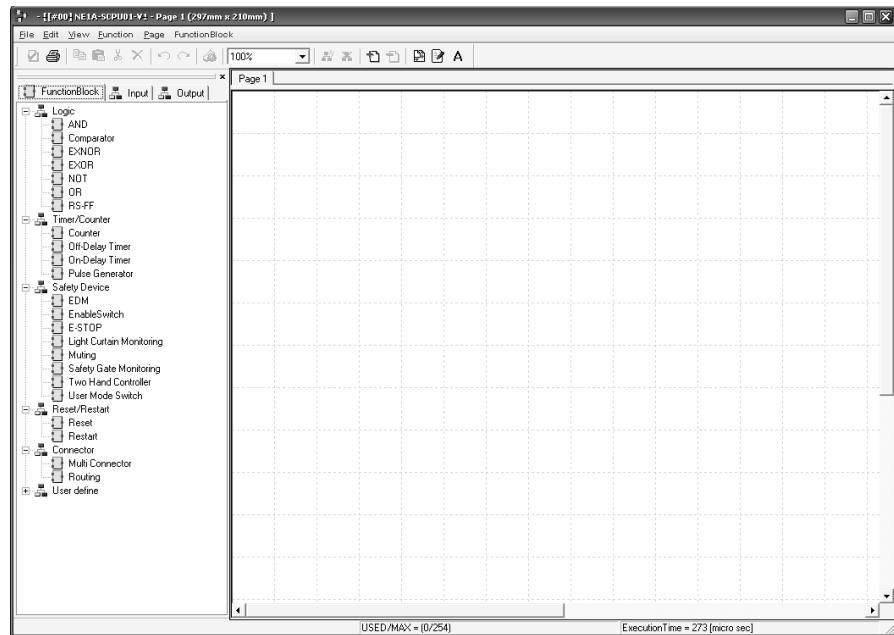

6-1-2 Exiting the Logic Editor

Use the following procedure to exit the Logic Editor.

1. Select **Exit** from the File Menu of the Logic Editor.
The Logic Editor will close
2. Click the **OK** Button in the Edit Device Parameters Window.

IMPORTANT

- To save the program and exit, the user must click the **OK** Button in the Edit Device Parameters Dialog Box when exiting the Logic Editor.
- If the user clicks the **Cancel** Button, none of the parameters entered until then, including the program, will be saved. Any programming saved temporarily by selecting **File - Apply** will also be deleted.

6-2 Menu Commands

The following tables describe the commands in the Logic Editor menus.

6-2-1 File Menu

Command	Description	Online	Offline
Apply	Temporarily saves the current program in the Configurator. Refer to <i>6-3-6 Saving the Program</i> .	OK	OK
Import	Reads a file saved using the Export Command.	OK	OK
Export	Saves the current program to a file. The user can use the saved file by importing it via another NE1A-series Controller. Connections between I/O tags and function blocks, however, are not saved.	OK	OK
Print	Prints the program. Refer to <i>Printing Programs</i> in <i>6-3-9 Monitoring the Program</i> .	OK	OK
Page Setup	Sets the page. Refer to <i>Page Settings</i> in <i>6-3-1 Workspace</i> .	OK	OK
Program Title	Sets the title and creator of the program. This information is added when the program is printed.	OK	OK
Exit	Exits the Logic Editor.	OK	OK

6-2-2 Edit Menu

Command	Description	Online	Offline
Cut	Cuts the selected function block and copies it to the clipboard.	OK	OK
Copy	Copies the selected function block to the clipboard.	OK	OK
Paste	Pastes the function block on the clipboard to the Workspace.	OK	OK
Undo	Undoes the previous operation.	OK	OK
Redo	Redoes the undone operation.	OK	OK
Select All	Selects all items.	OK	OK
Delete	Deletes the selected item.	OK	OK
Properties	Displays the property window of the selected function block.	OK	OK
Create Comment	Used to create any size text box by dragging the mouse.	OK	OK
Search Open Connection	Lists function blocks that are have open connections. Double-click a function block to display and edit it with the list still displayed. Note If an error occurs when a program created using version 1.3□ is opened or edited with version 1.5□ or higher, use this function to check and make corrections. Refer to <i>Finding Function Blocks with Open Connections</i> in <i>6-3-3 Programming Using Function Blocks</i> .	OK	OK
Set Time Parameters	Used to globally change time parameters in the function blocks that are currently used in the program. (Version 3.3□ or higher) Refer to <i>Globally changing time parameters for function block</i> <i>6-3-3 Programming Using Function Blocks</i> .	OK	OK

6-2-3 View Menu

Command	Description	Online	Offline
Function List	Displays or hides the Function List.	OK	OK
Status	Displays or hides the status bar.	OK	OK
Tool Bar	Displays or hides the toolbar.	OK	OK
Grid	Used to make grid settings such as display/hide grid, enable/disable grid alignment, and grid width settings. If grid display and alignment are enabled, a grid will appear on the Workspace and function blocks and I/O tags will be grid-aligned when pasted to the Workspace.	OK	OK

6-2-4 Function Menu

Command	Description	Online	Offline
Transmission Message Setting	Sets the explicit message send function. Refer to <i>Sending Explicit Messages</i> in 6-3-3 Programming Using Function Blocks.	OK	OK
Monitoring	Monitors I/O tag values and signal states of all the connection lines in the Logic Editor. Refer to 6-3-9 Monitoring the Program.	OK	---
Jump Address	Make New Jump Address Creates a new jump address (jump source). Refer to <i>Jump Addresses</i> in 6-3-3 Programming Using Function Blocks.	OK	OK
	Select Jump Address Pastes the destination of the jump address in the Workspace. Refer to <i>Jump Addresses</i> in 6-3-3 Programming Using Function Blocks.	OK	OK

6-2-5 Page Menu

Command	Description	Online	Offline
Add Page	Adds a new page after the last page. Refer to <i>Adding and Deleting a Page</i> in 6-3-3 Programming Using Function Blocks.	OK	OK
Insert Page	Inserts a new page immediately after the currently displayed page. Refer to <i>Adding and Deleting a Page</i> in 6-3-3 Programming Using Function Blocks.	OK	OK
Delete Current Page	Deletes the currently displayed page. Refer to <i>Adding and Deleting a Page</i> in 6-3-3 Programming Using Function Blocks.	OK	OK
Change Page Title	Changes the title of the currently displayed page. Refer to <i>Adding and Deleting a Page</i> in 6-3-3 Programming Using Function Blocks.	OK	OK

6-2-6 Function Block Menu

Command	Description	Online	Offline
Import	Imports a user-defined function block from a function block file (*.fbd). Refer to <i>Creating User-defined Function Blocks</i> in 6-3-4 <i>Programming User-defined Function Blocks</i> .	OK	OK
Export	Exports a user-defined function block to a function block file (*.fbd). Refer to <i>Reusing User-defined Function Block Files</i> in 6-3-4 <i>Programming User-defined Function Blocks</i> .	OK	OK
Export All Function Blocks	Groups all user-defined function blocks and exports to multiple function block files (*.fbd).	OK	OK
Create	Creates a new user-defined function block. Refer to 6-3-4 <i>Programming User-defined Function Blocks</i> .	OK	OK
Edit	Edits user-defined function blocks. Refer to 6-3-4 <i>Programming User-defined Function Blocks</i> .	OK	OK
Delete	Deletes imported user-defined function blocks.	OK	OK
Validate	Checks user-defined function blocks. Refer to <i>Reusing User-defined Function Block Files</i> in 6-3-4 <i>Programming User-defined Function Blocks</i> .	OK	OK
Property	Displays/edits user-defined function blocks.	OK	OK

6-3 Programming

6-3-1 Workspace

Page Settings

First, set the size of the Workspace. Select **File - Page Setup** from the menu bar.

The Workspace will consist of pages of the specified size. Pages can be added or deleted as required. When printing the program, each page will be printed at the specified size.

IMPORTANT The page setup cannot be changed if there are any items in the Workspace. Set the size of the Workspace first using **Page Setup**.

Programming Restrictions





Items, such as I/O tags and function blocks can be used on each page. The following restrictions apply.

- The same input tag can be placed on more than one page. The same input tag, however, can be used only once on each page.
- Each output tag can be used only once, even on different pages.
- When a function block is pasted, it is placed in the same position as the function block that was copied. When pasting a function block on the same page, move the source function block.
- Up to 128 function blocks can be used with Pre-Ver. 1.0 NE1A-SCPU01 Controllers and up to 254 function blocks can be used with NE1A-series Controllers with unit version 1.0 or later (including NE1A-SCPU01-EIP and NE1A-SCPU02-EIP).
- Up to 128 number jump addresses can be used.
- A maximum of 8 characters can be used for the tag name of the jump address.
- Up to 32 pages can be added.
- Up to 128 text boxes (comments) can be created.

6-3-2 Function Blocks

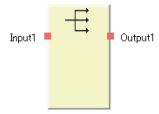
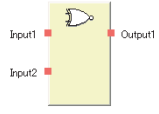
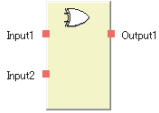
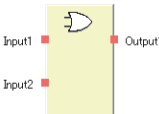
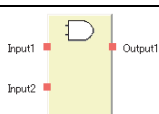
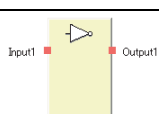
The Network Configurator can create Safety Logic by combining any logic functions and function blocks supported by the NE1A-series Safety Network Controller. These are listed below.

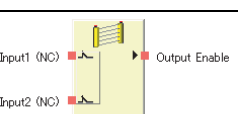
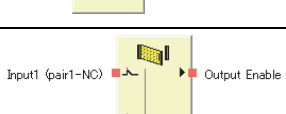
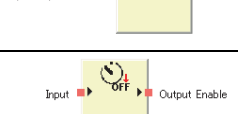
Function Blocks

Name	Notation on Function List	Display on the Network Configurator Logic Editor Screen	Details
Routing	Routing		Allocates an input signal to up to 8 signals. Used for signal outputs to multiple physical addresses (output I/O tags).
Exclusive NOR	EXNOR		Outputs the exclusive NOR of the input conditions.
Exclusive OR	EXOR		Outputs the exclusive OR of the input conditions.
OR	OR		Outputs the logical OR of the input conditions.
AND	AND		Outputs the logical AND of the input conditions.
NOT	NOT		Outputs the logical complement of the input condition.
Two Hand Controller	Two Hand Controller		Monitors two hand switch status.
Light Curtain Monitoring	Light Curtain Monitoring		Monitors Type 4 Safety Light Curtains.
Safety Gate Monitoring	Safety Gate Monitoring		Monitors the safety gate status. The safety gate status is monitored using input signals from safety door switches, safety limit switches, and other switches mounted to the gate.
Off-Delay Timer	Off-Delay Timer		Operates an OFF-delay timer set in 10-ms units.
On-Delay Timer	On-Delay Timer		Operates an ON-delay timer set in 10-ms units.

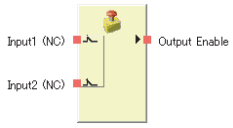
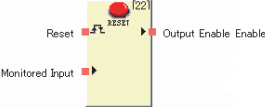
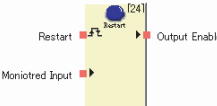
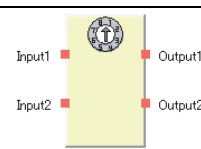
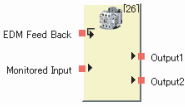
Name	Notation on Function List	Display on the Network Configurator Logic Editor Screen	Details
Emergency Stop Switch Monitoring	E-STOP		Monitors the status of the emergency stop switch.
Reset	Reset		Turns ON the Output Enable signal when the reset signal is correctly input while the input condition for the Reset function block is ON.
Restart	Restart		Turns ON the Output Enable signal when the restart signal is correctly input while the input condition for the Restart function block is ON.
User Mode Switch Monitoring	User Mode Switch		Monitors the operating mode switch for the user system or device.
External Device Monitoring	EDM		Evaluates the input signal and external device status and sends a safety output to the external device.

Function Blocks Supported by NE1A-series Controllers with Unit Version 1.0 or Later (Including NE1A-SCPU01-EIP and NE1A-SCPU02-EIP)

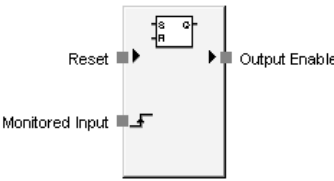
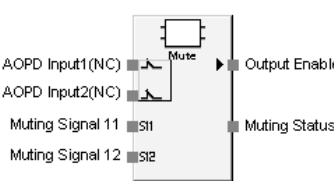
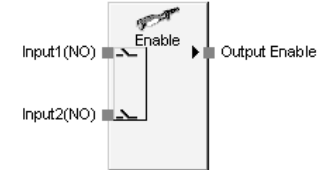
Name	Notation on Function List	Display on the Network Configurator Logic Editor Screen	Details
Reset Set Flip-Flop	RS-FF		When Input 1 turns ON, RS-FF holds the ON status in the function block and connects to Output 1 for output. Because the ON status is held in the function block, the ON status continues to be output even when Input 1 turns from ON to OFF. When Input 2 is turns ON, the signal held in the function block turns OFF.
Muting	Muting		Temporarily disables the light curtain detection operation when the muting sensor is detected.
Enable Switch	Enable Switch		Monitors enable switch device inputs.

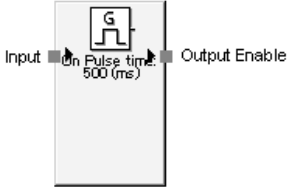
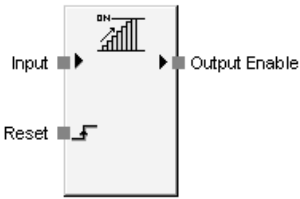
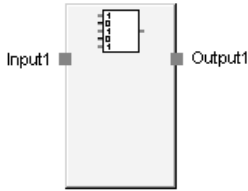
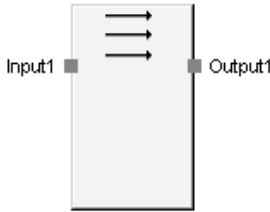
Name	Notation on Function List	Display on the Network Configurator Logic Editor Screen	Details
Pulse Generator	Pulse Generator	 <p>The diagram shows a rectangular block with an 'Input' terminal on the left and an 'Output Enable' terminal on the right. Inside the block, there is a square wave icon and the text 'Pulse time 500 (ms)'.</p>	Outputs ON/OFF pulses on Output 1 while Input 1 is ON.
Counter	Counter	 <p>The diagram shows a rectangular block with an 'Input' terminal on the left, an 'Output Enable' terminal on the right, and a 'Reset' terminal at the bottom. Inside the block, there is a bar graph icon and the text 'ON'.</p>	Counts the number of input signals and turns ON Output 1 when the count reaches the number set in the configuration data.
Comparator	Comparator	 <p>The diagram shows a rectangular block with an 'Input1' terminal on the left and an 'Output1' terminal on the right. Inside the block, there is a square wave icon.</p>	Compares input signals (8 max.) with the comparison value set in the configuration, and turns ON Output 1 when all the input signals match the set values.
Multi Connector	Multi Connector	 <p>The diagram shows a rectangular block with an 'Input1' terminal on the left and an 'Output1' terminal on the right. Inside the block, there are three horizontal arrows pointing from left to right.</p>	Outputs input signals (8 max.) to output signals (8 max.). The input and output signals correspond 1:1 from 1 to 8 respectively, and are not affected by the status of other input signals.

6-3-3 Programming Using Function Blocks

Improved Operability with Version Upgrade (Version 1.5 or Higher)

The following operations are possible with Network Configurator version 1.5 or higher.

- Undo/Redo (Edit Menu)
- Copying and Pasting I/O tags, connections, and text boxes (comments) (only function block copying and pasting was possible with earlier versions).
- Cutting I/O tags, connections, text boxes, and jump addresses (only function blocks could be cut with earlier versions).
- Copying function blocks to a location by selecting the function block, holding the Ctrl Key, and drag-and-dropping the function block to that location.
- Select All command added to the Edit Menu.
- Searching I/O tags being used
I/O tags being used in programs can be searched. Double-click the highlighted item in the I/O list in the Object List to display the page in the program where the I/O tag is being used and the I/O tag will appear flashing in red.
- Linking jump addresses
Double-click a jump address to change the display to the corresponding jump address.
- Adding pages after the currently displayed page (pages could be added only after the last page with earlier versions). (Use the Page Menu or right-click the Page Tab.)
- Deleting pages other than the last page (only the last page could be deleted with earlier versions). (Use the Page Menu or right-click the Page Tab.)
- Aligning function blocks, I/O tags, and other object on a grid when pasting. (Select **View – Grid**.)
- Placing text boxes (comments) in the Workspace. (Select **Edit – Create Text Box** then drag the mouse to create the text box area. Double-click the created text box to display the Edit Text Box Dialog Box. Input the comment and click the **OK** Button to write a comment in the text box. To change the comment, double-click the text box to display the Edit Text Box Dialog Box and change the comment in the text box.)
- Displaying function block help. (Right-click the function block in the Object List or the Workspace and select **Help**.)
- Changing the I/O tag color.
Right-click the I/O tag in the Object List or Workspace to display the pop-up menu. Select **Change Color** to change the color.

Note The Undo command can be used to undo up to the last 5 operations.

Input Tag Placement

1. Click the **Input** Tab in the Object List.
2. Select the input tag to be used and drag-and-drop it to the desired location in the Workspace. More than one I/O tag can be selected and drag-and-dropped to the Workspace.

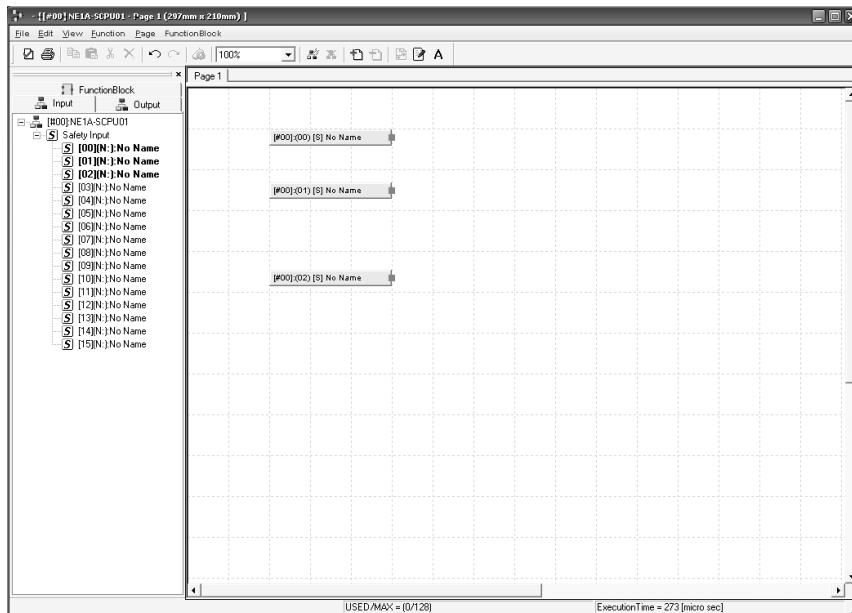

Function Block Placement

1. Click the **Function Block** Tab in the Object List.
2. Select the Function Block to use, drag it to the Workspace, and drop it where you want to position it.

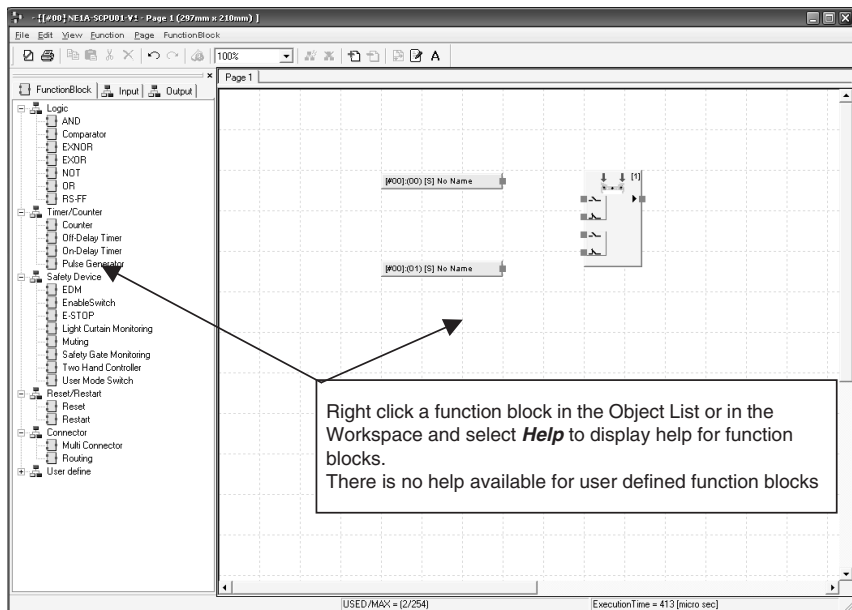

Note Help can be displayed for function blocks. (Right-click a function block in the Object List or in the Workspace and select **Help**).

Output Tag Placement

1. Click the **Output** Tab in the Object List.
2. Select the output tag to use, drag it to the Workspace, and then drop it where you want to position it.
The user can select multiple output tags and position them at the same time.

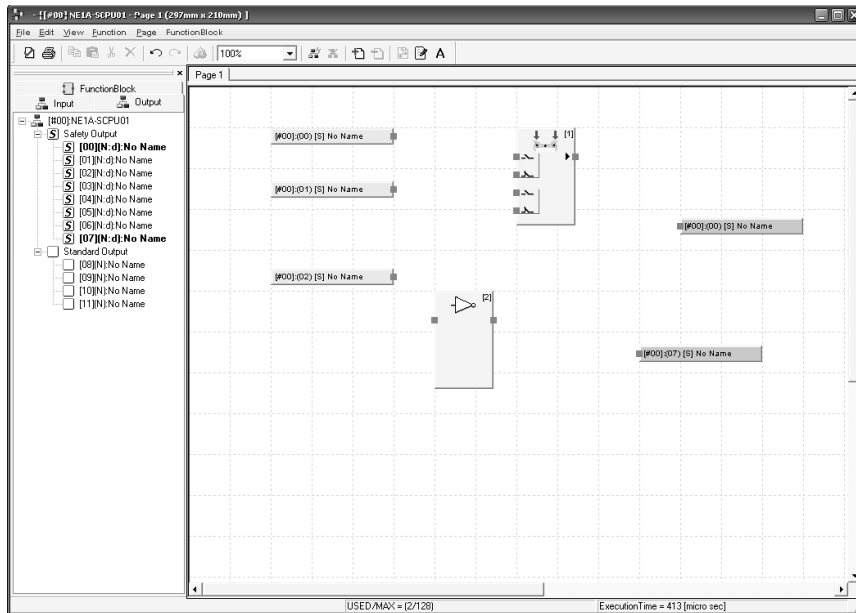

Note With Network Configurator version 2.0 or higher, the mouse cursor will change as shown in the following figure when the user attempts to place or move function blocks or I/O tags if placement is prohibited. This change indicates that placement and moving are not possible in the current cursor position.

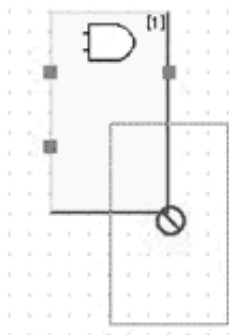

Connections

Connect the I/O tags and the function block.

1. Click the source connector (■) and drag it to the destination connector.

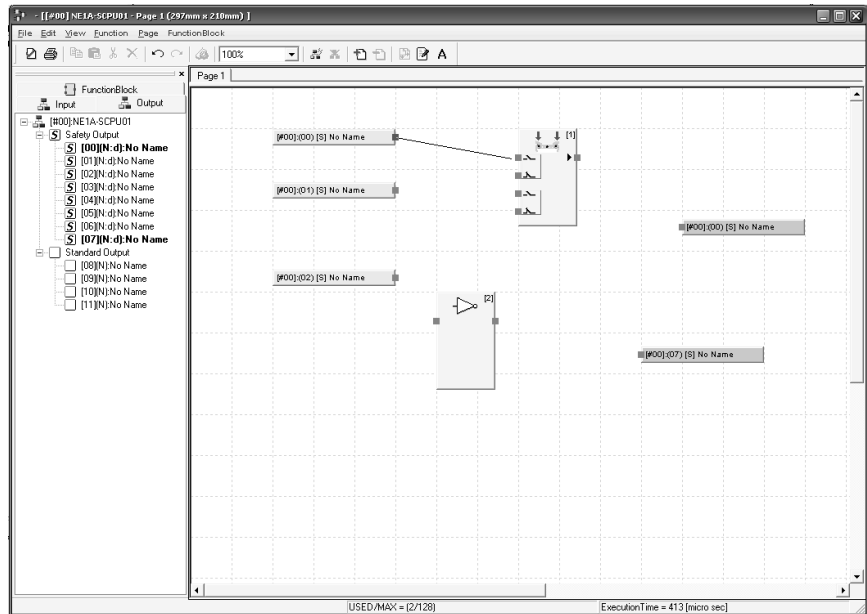

Note The position of connections can be moved and saved after they are connected. Connection position data, however, cannot be saved to an NE1A-series Controller. Therefore, if the programming is uploaded from the device, connection position data will be lost, and the system will return to automatic connections.

2. Repeat this operation to create the program.

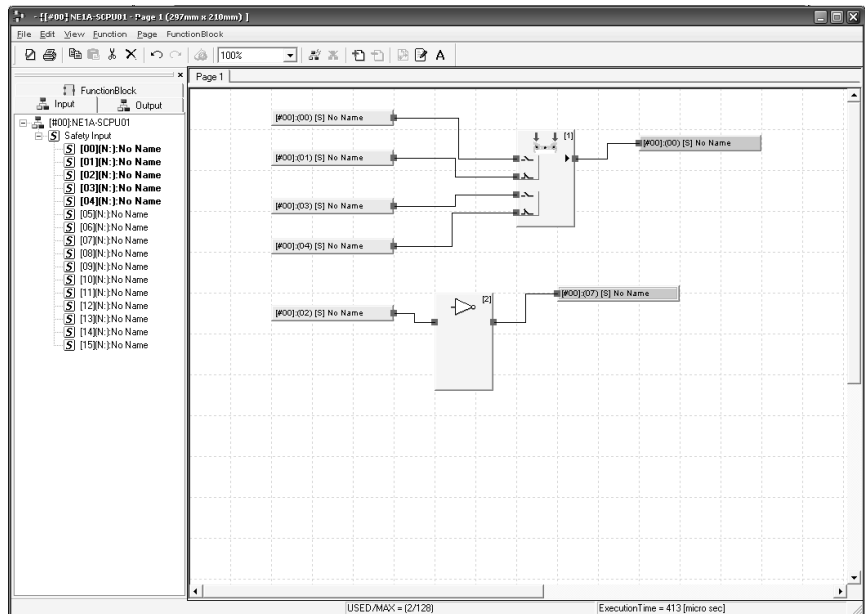

I/O Tags

This section describes the I/O tags in the Object List.

■ **Icons**

The icons in the Object List have the following meanings.

Icon	Meaning
[S]	Safety I/O data for the local Safety Network Controller or data for another device on the network that was received through safety I/O communications.
□	Non-safety I/O data for the local Safety Network Controller or data for another device on the network that was received through standard I/O communications.

IMPORTANT I/O tags for which the [S] icon is displayed are for non-safety data in the following cases. Do not use this data to build a safety system.

- I/O tags connected to standard devices
- I/O tags for data that is non-safety data at the safety I/O communications partner
- I/O tags for data that was input or output with standard I/O communications at the safety I/O communications partner

Refer to the user’s manual for the communications partner device to see if data is safety data or non-safety data.

Note I/O tags in the work area have an “S” symbol instead of the icon.

■ **I/O Configuration Information Display**

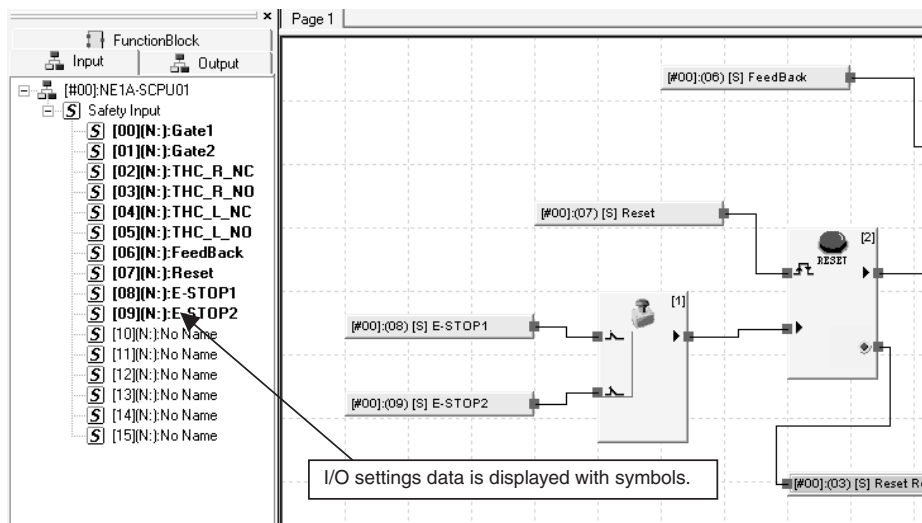

Symbols are displayed in the I/O tags in the Object List for the I/O configuration information.

The meanings of the symbols are given in the following tables.

Display	Input mode	Display	Channel mode
N	Not Used	None	Single Channel
P	Test pulse from Test out	e	Dual Channel Equivalent
S	Used as safety input	c	Dual Channel Complementary
ST	Used as standard input	---	---

Display	Output mode	Display	Channel mode
N	Not Used	None	Single Channel
S	Safety	d	Dual Channel
P	Safety Pulse Test	---	---

Display	Test Output mode
N	Not Used
ST	Standard input
P	Pulse Test
PW	Power Supply Output
ML	Muting Lamp Output

Note I/O configuration information is not displayed for I/O tags in the work area.

■ **Searching for I/O Tags**

I/O tags that are being used in the program are displayed in bold text in the Object List, as shown below. If you double-click a bold I/O tag, the location in the program where the I/O tag is used is displayed.

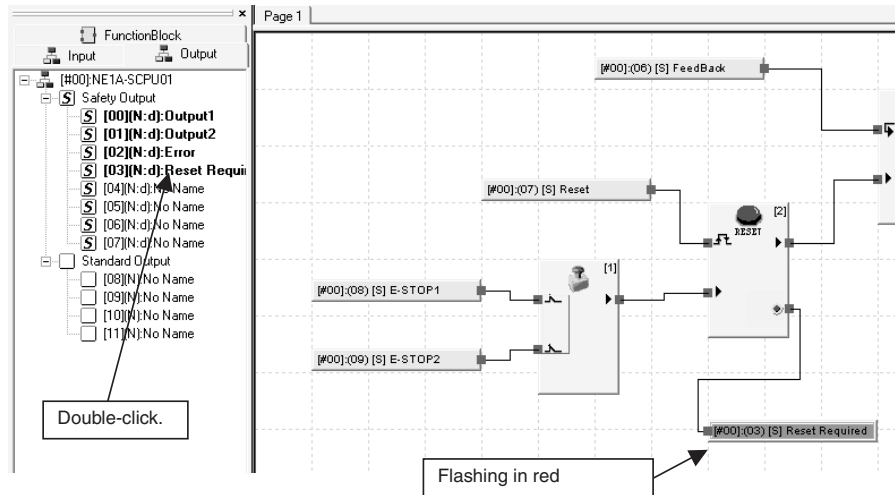

Note If an input tag is being used on more than one page, keep double-clicking to change the display to the next page. Click the Workspace or perform any another operation to return to the first page.

Deleting Items

Use any of the following methods to delete I/O tags, function blocks, or connections.

1. Select the item to delete and then select **Edit - Delete** from the menu bar.
2. Select the item to delete and then click the **Delete** Button on the toolbar.
3. Right-click the item to delete and then select **Delete** from the pop-up menu.
4. Select the item to delete and then press the **Delete** Key or **Backspace** Key.

Adding and Deleting a Page

Inserting a Page (Adding a New Page between Pages)

Pages can be inserted using either of the following methods. A new page will be added between other pages.

1. Select **Page - Insert Page** from the menu bar.
2. Right-click the **Page** Tab and select **Insert Page**.

Adding a Page

To add a page, use either of the following methods. A new page will be added after the last page.

1. Select **Page - Add Page** from the menu bar.
2. Click the **Add Page** Button on the toolbar.

Deleting a Page

To delete a page, use either of the following methods. The currently displayed page will be deleted.

1. Select **Page - Delete Last Page** from the menu bar.
2. Click the **Delete Page** Button on the toolbar.
3. Right-click the **Page** Tab and select **Delete Page**.

Page Title

The user can enter a title for each page. The title can be entered when adding a page, or it can also be entered using either of the following methods:

1. Display the page for which the title is to be changed and select **Page - Change Page Title** from the menu bar.
2. Display the page for which the title is to be changed and right-click the **Page** Tab and select **Change Page Title**.

Jump Addresses

The *Jump Address* menu commands can be used when the program is complex or when it spans multiple pages.

1. First, set the source jump address using either of the following methods:
 - a. Select **Function - Jump Address - New** from the menu bar.
 - b. Right-click in Workspace and select **Jump Address**.



2. Enter a name for the jump address and click the **OK** Button. The jump address will be displayed as follows:

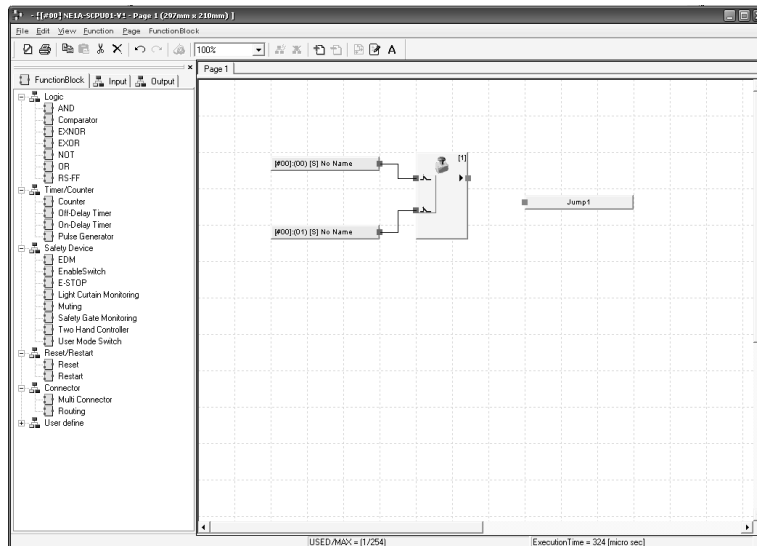

3. Enter the jump destination using either of the following methods:
 - a. Select **Menu - Jump Address - Select** from the menu bar.
 - b. Right-click in the Workspace and select **Select Jump Address**.

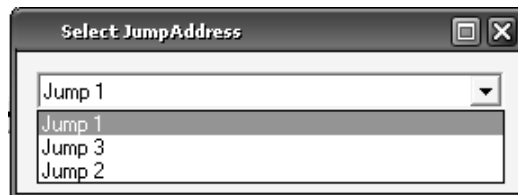

4. Select the name of the jump source and click the **OK** Button. The jump address will be displayed as follows:

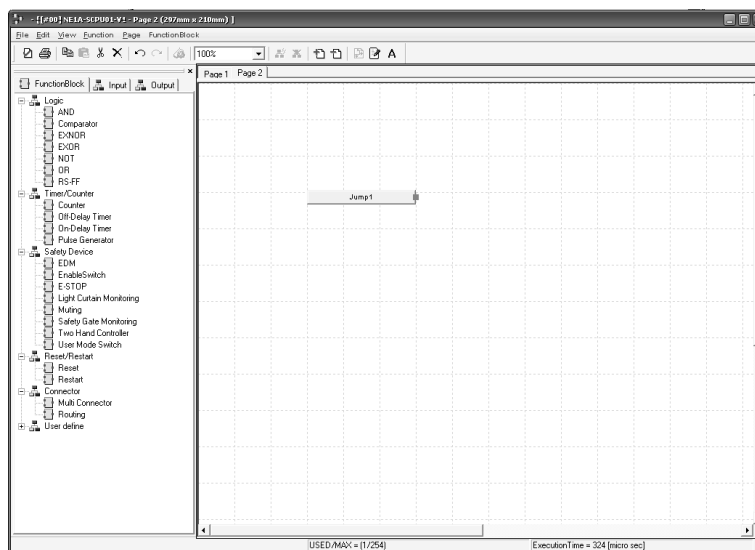

Note Double-click a jump address to change the display to the corresponding jump address.

Function Block I/O Information

The input and output descriptions for a function block are displayed when the mouse cursor is placed on the corresponding I/O point on the screen.

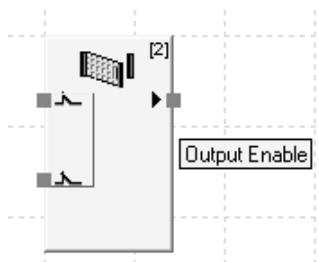

Editing Function Block Parameters

To edit the parameters of a function block, use any of the following methods to display the Parameter Edit Window.

1. Double-click the function block.
2. Select the function block and then select **Edit - Properties** from the menu bar.
3. Right-click the function block and the select **Edit** from the pop-up menu.
4. Select the function block and then click  **Property** on the toolbar.

Note The parameters that can be edited depend on the function block. For details, refer to the *Safety Network Controller Operation Manual (Z906)*.

Parameters

Click the **Parameter** Tab to set the parameters of the function block.

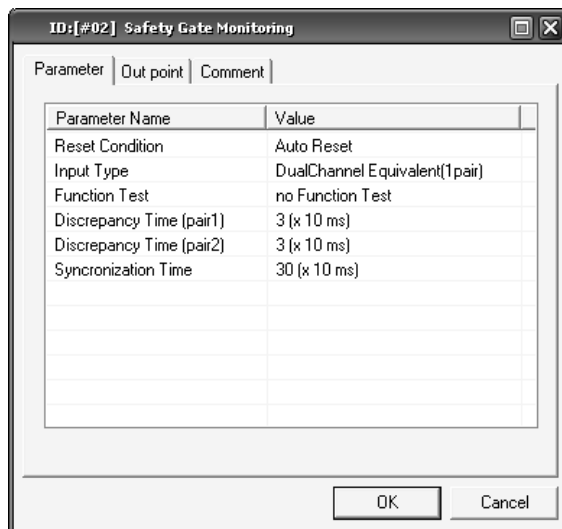

Input/Output Settings

Click the **In/Out Setting** Tab to set the number of inputs or outputs and the *Fault Present* Option.

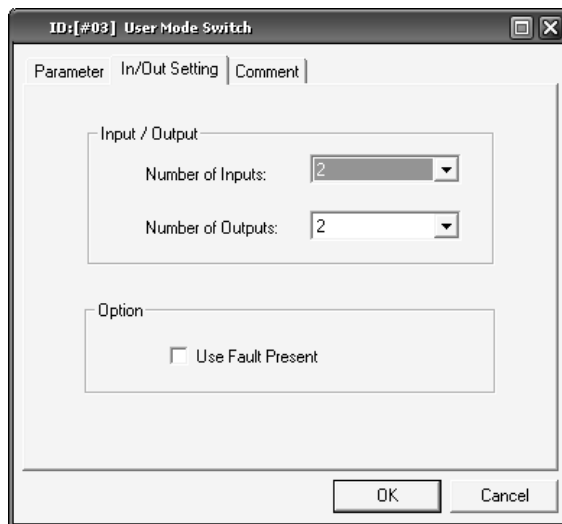

Setting Output Points

Click the **Set Output Point** Tab and set whether or not to use the different output point functions for function blocks.

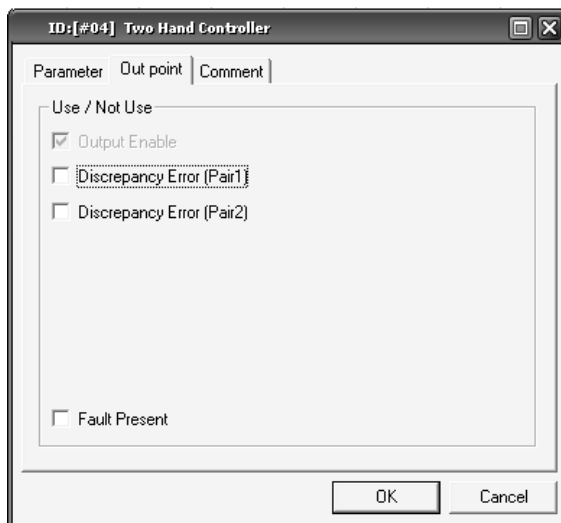

Setting Comments

Click the **Comment** Tab to enter names for the function block or I/O signals. The names of I/O signals are not displayed in the window, but the name of the function block is displayed under the function block in the window. The user can select to display or hide all the names entered in this window when the program is printed.

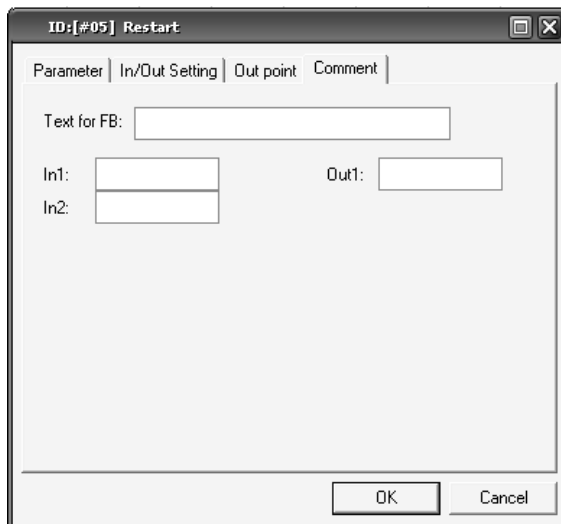

Note With Network Configurator 1.6 or lower, the number of inputs cannot be deleted if a connection is made as shown in the following figure (i.e., if a connection is made at the bottom of the inputs and some inputs are not connected.) With Ver. 2.0 or higher, however, the number of inputs can be deleted up to the number of connections made.

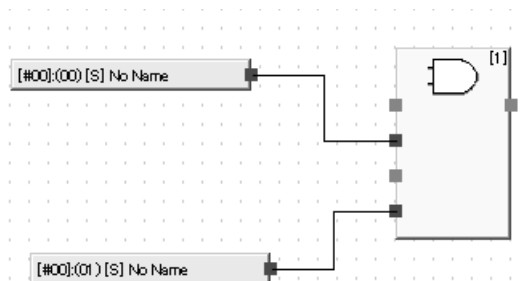

Globally Changing Time Parameters for Function Block (Version 3.3 or Higher)

Of the function block parameters, any time parameters must be set to values that are equal to or longer than the cycle time of the NE1A-series Controller. If the cycle time of the NE1A-series Controller is changed, you can globally change the settings of these parameters.

Select **Edit - Set Time Parameters** from the menu bar.

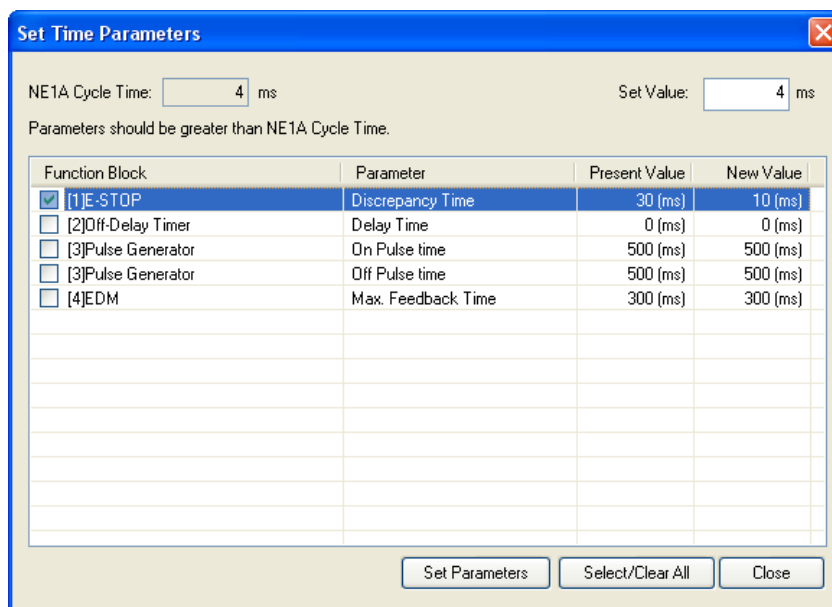

NE1A Cycle Time

The cycle time of the NE1A -series Controller is calculated automatically and displayed.

Set Value

Set the value to which to globally change the time parameters.

Present Value

The current value of the parameter is displayed.

New Value

This is the actual value that was set with the **Set Parameters** Button. This value is calculated based on the maximum value, minimum value, and setting unit of the parameters for the *Set Values*.

Set Parameters

The Set Parameters button changes the value of all parameters that are selected to the New Value.

Select/Clear All

This Select/Clear All button selects or clear the selection of all of the parameters in the list.

Close

This button closes the dialog box.

Sending Explicit Messages

An explicit message can be set in advance and then sent when an output tag turns ON as a trigger. One explicit message can be set for the entire program. (A response is not received to indicate the results of sending the message.)

Select **Function - User EM** from the menu bar.

Trigger Address

Select the output tag to function as the trigger for sending the explicit message. Every time the specified output tag changes from OFF to ON, the explicit message set as the send message will be sent.

Retry Count

Set the number times sending will be retried if explicit message transmission fails.

Set to 0 for no retries.

Send Message

- Target Node
Set in hexadecimal the destination node address to which to send the explicit message.
- Service Code
Set the service code of the explicit message in hexadecimal.
- Class ID
Set the class ID of the explicit message in hexadecimal.
- Instance ID
Set the instance ID of the explicit message in hexadecimal.
- Service Data
Set any service data in hexadecimal.

Finding Function Blocks with Open Connections

Newly created programs containing function blocks with open inputs or outputs (see diagram) cannot be downloaded. For this reason, all I/O must be used.

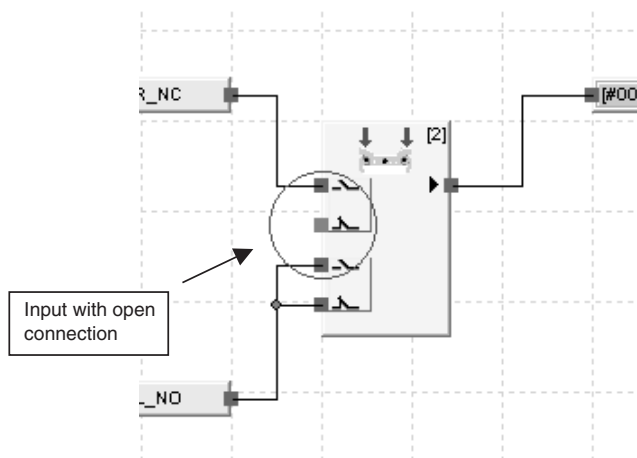

Select **Edit - Search Open Connection**. The following dialog box will be displayed.

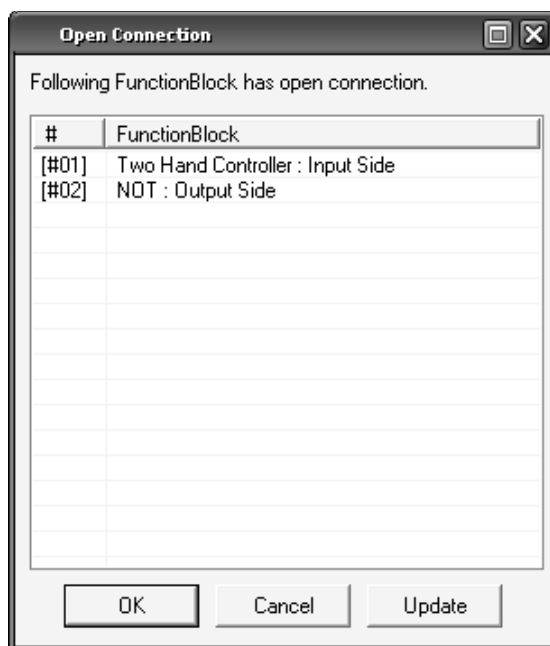

As shown in the diagram, function blocks with open I/O connections will be listed. Double-click the list to display the corresponding function block (with the open connection).

Note Open I/O connections are displayed in red. If a jump address is used for the I/O and the corresponding jump address is not used, however, the I/O will not be displayed in red and will appear to be connected.

6-3-4 Programming User-defined Function Blocks

User-defined function blocks are created and used using the following steps.

- Create a user-defined function block.
- Create a program that uses the user-defined function block.
- Check operation of the program that includes the user-defined function block.

User-defined function blocks can be imported and exported and used by other users by following these steps.

- Export/import the user-defined function block.
- Re-use the user-defined function block.

The procedure is described in detail below.

Creating User-defined Function Blocks

Creating a New User-defined Function Block

1. Select **Function Block – Create** from the Logic Editor Function Block Menu.

The Logic Editor for creating a function block and the IO Property Dialog Box will be displayed.

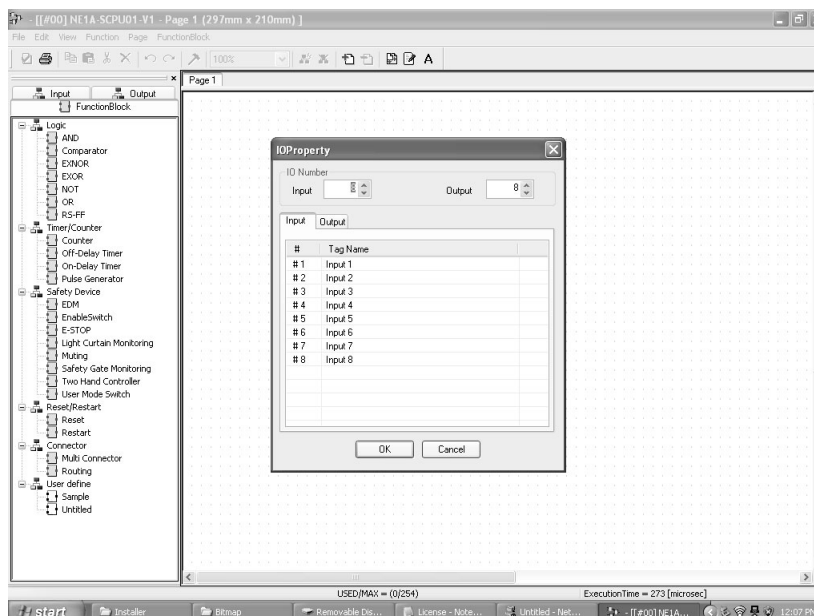

2. The number of inputs and outputs and the tag name are set in the IO Property Dialog Box. The tag name can also be set later.

The Logic Editor for creating a function block will be displayed.

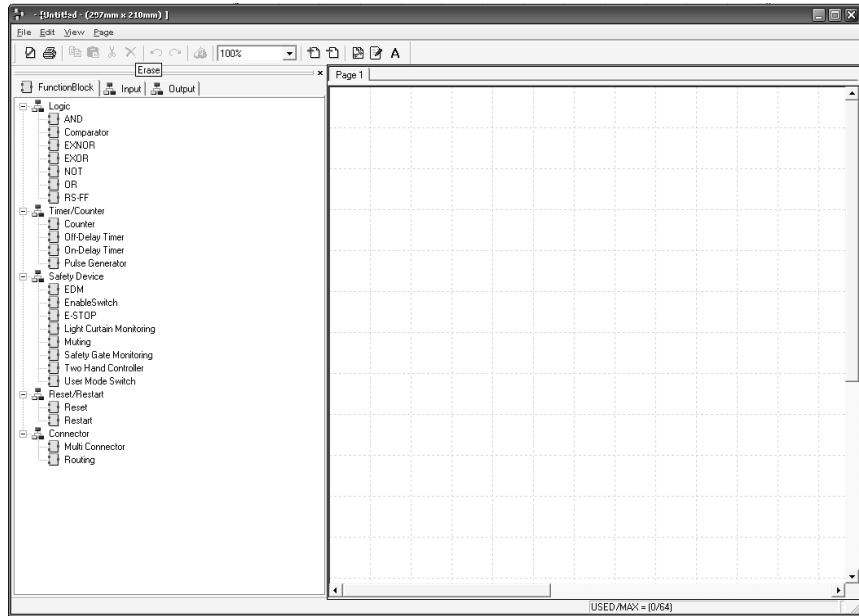

3. Create the program by placing and connecting function blocks, input tags, and output tags.
 Refer to *6-3-3 Programming Using Function Blocks* for information on how to use the Logic Editor.

Example Programming a User-defined Function Block:

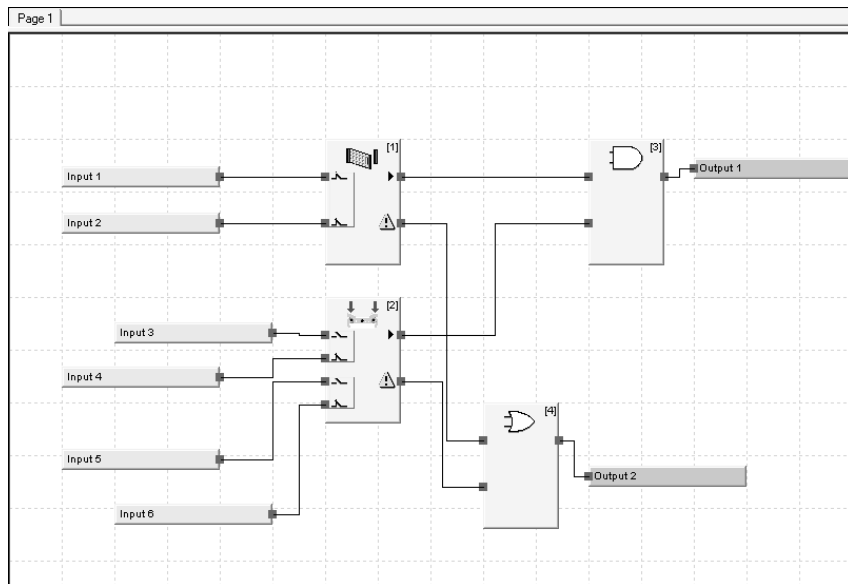

4. Save the user-defined function block.
 - Select **File – Apply** from the Logic Editor menu for creating a user-defined function block.
 - Set the user-defined function block name in the Function Block Name Dialog Box and click the **OK** Button.
 The saved user-defined function block will appear on the Logic Editor Object List.

Example screen:

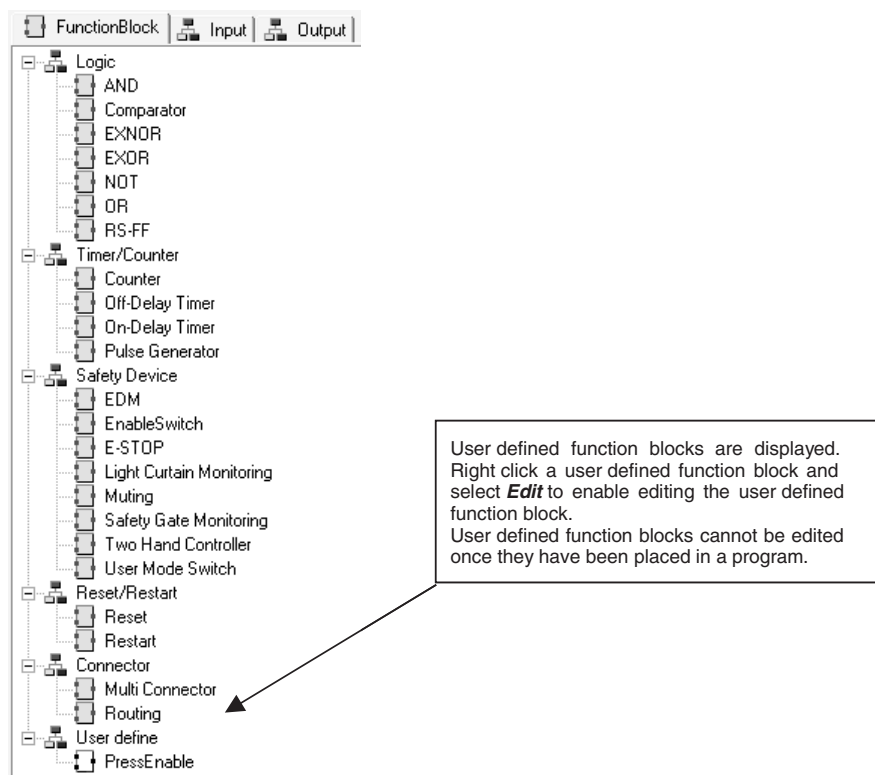

Note The following characters cannot be used in user-defined function block names.

¥ / : ; * ? < > | & ' "

Creating Programs Using User-defined Function Blocks

Importing User-defined Function Blocks

User-defined function blocks must be imported before they can be used in a program. (They do not need to be imported if they are already present.)

1. Use the Network Configurator to allocate a new NE1A-series Controller to the network and open the Logic Editor.
2. Select **Function Block – Import** from the main Logic Editor menu. The Open Dialog Box will be displayed.

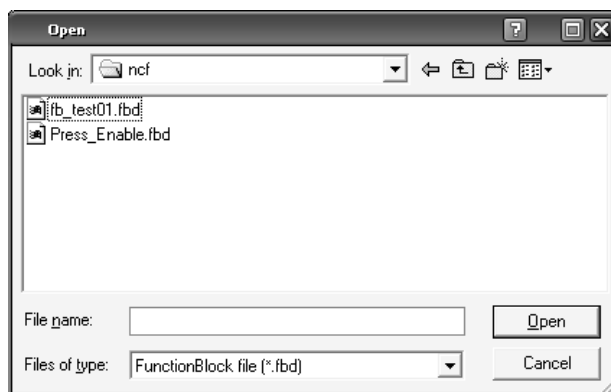

3. Select the file and click the **Open** Button.

The imported user-defined function block will be displayed in the Logic Editor Object List.

Example Screen:

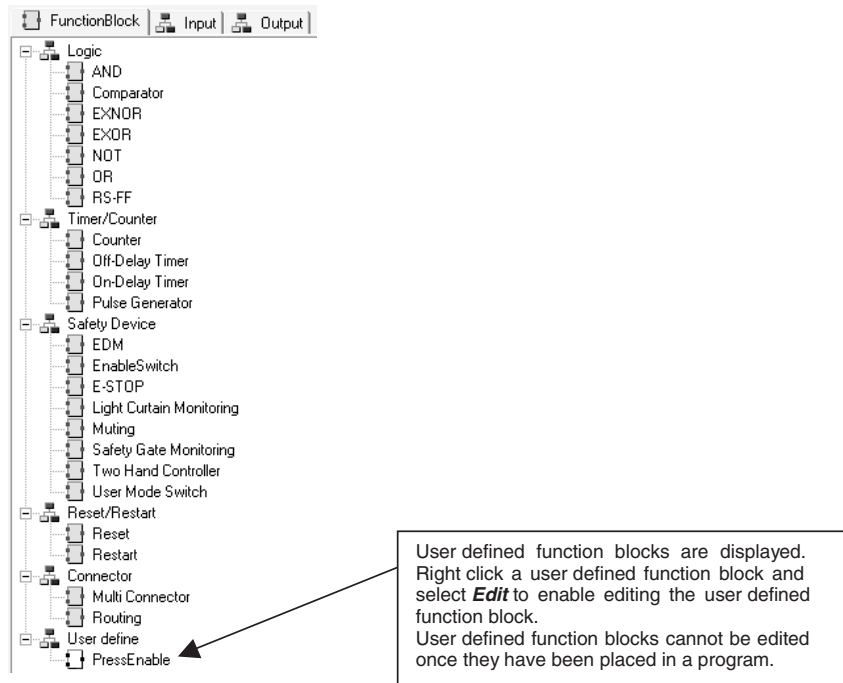

Allocating User-defined Function Blocks

Imported user-defined function blocks can, like normal function blocks, be selected from the Logic Editor Object List and drag-and-dropped to the Workspace and used.

Example of Using User-defined Function Block:

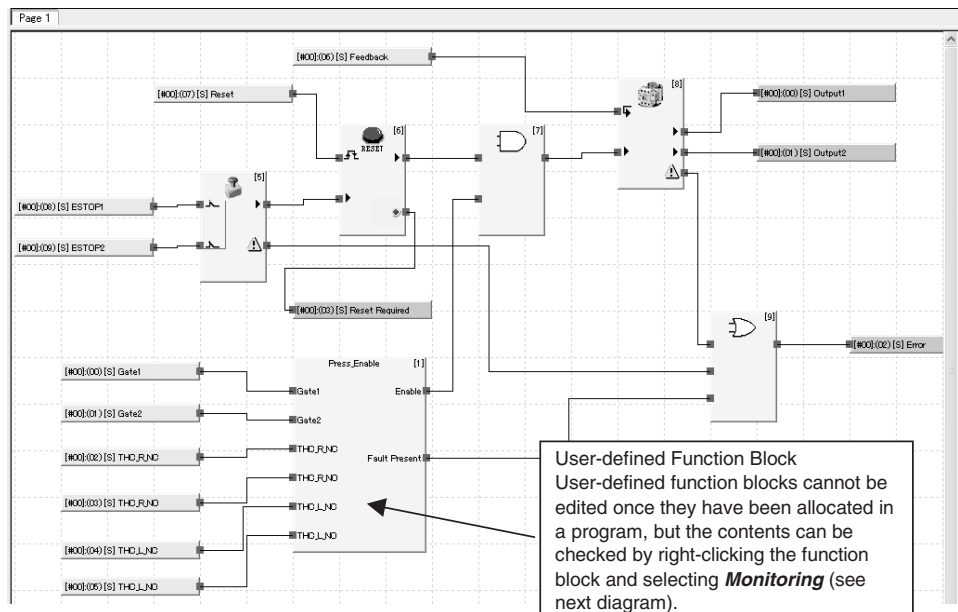

Editing Function Block Parameters Used in User-defined Function Blocks

This section describes how to change function block parameters used in user-defined function blocks.

1. As shown in the following figure, right-click the function block or right-click the function block list and select **Edit parameter of a User defined Function Block** when the menu is displayed.

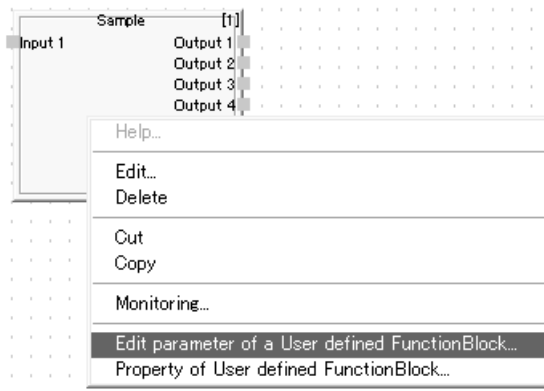

The following Function Block List Window will be displayed.

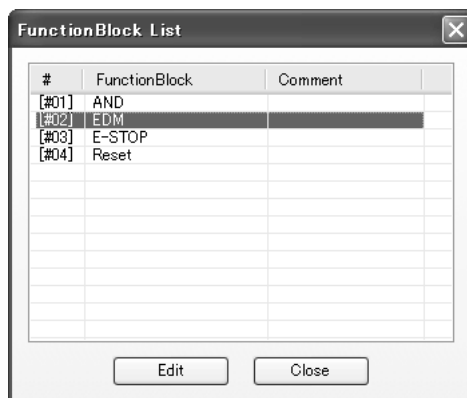

2. In the Function Block List Window, select the function block to be edited, and click the **Edit** Button. The menu for editing the parameters of the corresponding function block will be displayed.

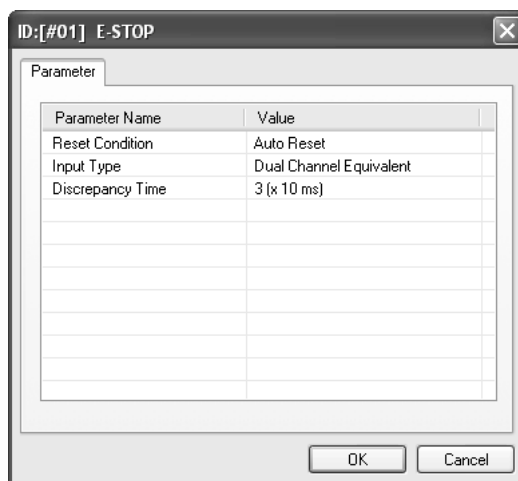

3. Edit the parameters, and then click the **OK** Button. The parameter will be changed, and then the filter will be updated.

- Note**
- (1) Parameter changes are performed for the file.
If a user-defined function block is edited, the changes will be applied to all instances of that user-defined function block.
 - (2) Parameters that change the number of inputs or outputs of a function block cannot be edited (e.g., setting the number of I/O, setting to use or not use Fault Preset, and changing from Dual Channel to Single Channel).

Precautions When Using User-defined Function Blocks

User-defined function blocks cannot be edited once they have been allocated in a program. Editing must be performed while the function block is not being used in a program. To check the contents after allocation, right-click the user-defined function block in the program and select **Monitoring** or **Edit** (see next diagram).

Example Screen Display When User-defined Function Block Is Right-clicked and **Monitoring** Is Selected:

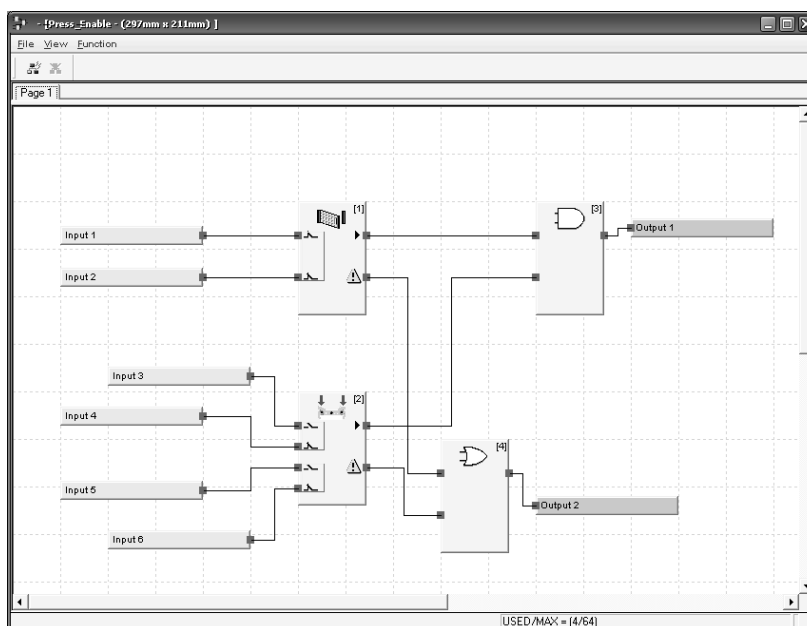

- Note** The values for I/O tags in function blocks and the status of signal connections with function blocks can be monitored online if the Network Configurator is online and the NE1A-series Controller is in RUN mode.

The following diagram shows how I/O that are not used in user-defined function blocks are displayed on screen. Used outputs are indicated in red and unused outputs are indicated in gray. Unused I/O connections cannot be connected.

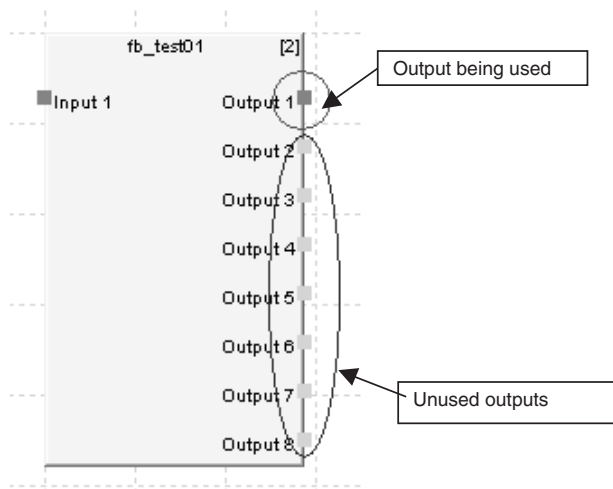

Checking Operation of Programs with User-defined Function Blocks

Always download programs with user-defined function blocks to the NE1A-series Controller and check operation before using them in an application.

Reusing User-defined Function Block Files

Project files (*.ncf/*.nvf files) and user-defined function block files (*.fbd files) exist as separate files. This allows a user to reuse user-defined function blocks created by a different user when creating programs. The procedure to reuse user-defined function blocks is described below.

Creating User-defined Function Blocks

Refer to 6-3-3 Programming Using Function Blocks.

Checking User-defined Function Blocks

Before distributing user-defined function blocks, check the operation and change the user-defined function block status to **Validated**.

1. Right-click the imported user-defined function block in the Logic Editor Object List and select **Edit**.
The Logic Editor for creating function blocks will start and the user-defined function block will be displayed.
2. Check the user-defined function block program and, if there are no problems, close the Logic Editor (**File – Close**).
3. Right-click the imported user-defined function block in the Logic Editor Object List and select **Validate**.
The following dialog box will be displayed.

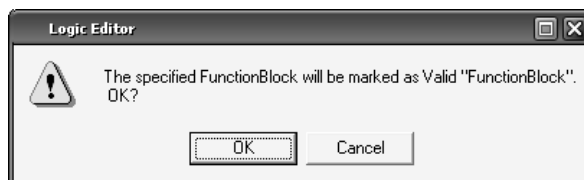

4. Click the **OK** Button.
The icon for the checked user-defined function block will change from white to yellow.

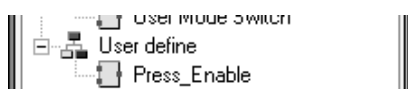

Exporting User-defined Function Blocks

A user-defined function block can be exported (i.e., saved as a user-defined function block file).

1. Click the saved user-defined function block in the Logic Editor Object List to select it.
2. Select **Function Block – Export** from the Logic Editor main menu.
The Save As Dialog Box will be displayed.

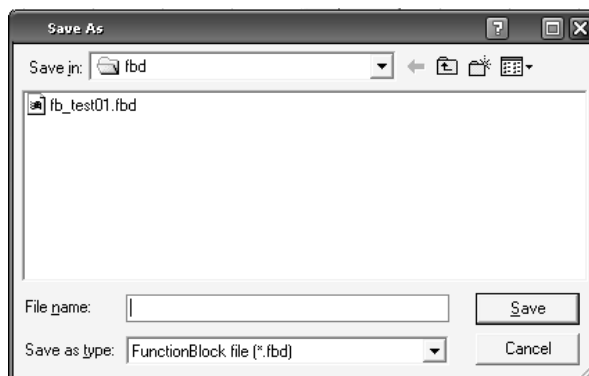

3. Enter the file name and click the **Save** Button.
The user-defined function block will be saved in a user-defined function block file (*.fbd).

Note Select **Function Block – Batch Export** to export all user-defined function blocks in a group.

Distributing User-defined Function Block Files

Once the file has been exported, move the saved file to the personal computers on which it is to be reused.

Importing User-defined Function Blocks

A user-defined function block must first be imported before it can be used in a program.

1. Use the Network Configurator to allocate a new NE1A-series Controller to the network and open the Logic Editor.
2. Select **Function Block – Import** from the Logic Editor main menu.
The Open File Dialog Box will be displayed.

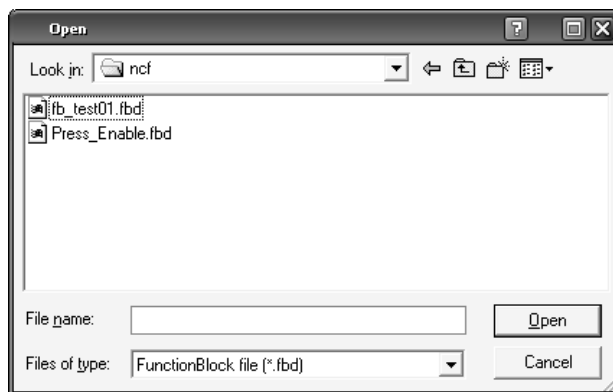

Note Multiple files can be imported simultaneously by selecting them in the Open File Dialog Box.

3. Select the file and click the **Open** Button.

The imported user-defined function block will be displayed in the Logic Editor Object List.

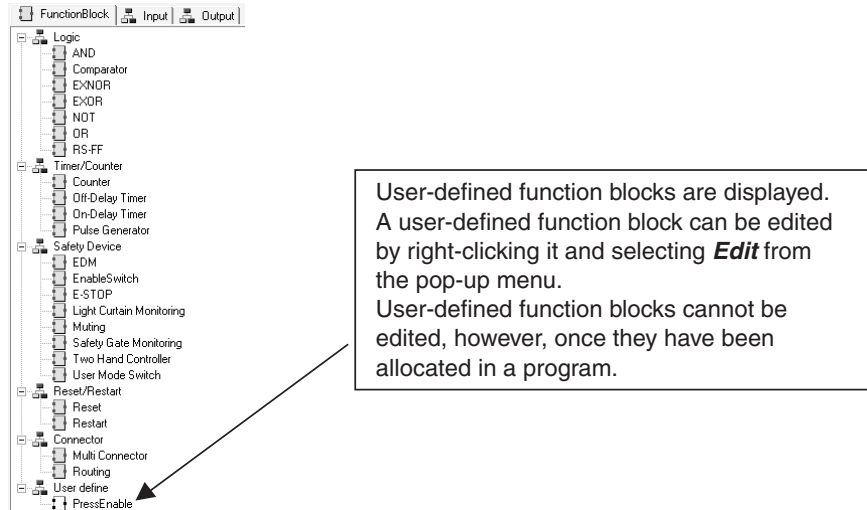

User-defined function blocks that are no longer required can be deleted.

1. Click the user-defined function block to be deleted on the Logic Editor Object List.
2. Select **Function Block – Delete** from the Logic Editor main menu.

Note Deleted user-defined function blocks cannot be restored. Be sure you do not need the function block before deleting it.

Precautions When Using User-defined Function Block Files

Project files (*.ncf/*.nvf files) and user-defined function block files (*.fbd files) exist as separate files. This section describes the relationship between project files and user-defined function block files.

Saving Programs

Apply the program (select **File – Apply**) in Logic Editor to temporarily save data for all function blocks used in a program (including those used inside user-defined function blocks) (see note). This data will include all data required for NE1A-series Controller operation.

Note Once you exit Logic Editor and click the **OK** Button in the NE1A-series Controllers’ Edit Device Parameters Dialog Box, the data will be saved to a project file.

Reading Project Files

Project files can still be read normally even if there are no user-defined function block files.

Downloading Programs

Configurator data can still be downloaded normally even if there are no user-defined function block files.

Uploading Programs

Once programs that include user-defined function blocks have been downloaded to the NE1A-series Controller, they can still be uploaded normally even if there are no user-defined function block files.

Displaying Program Reports

Always import the user-defined function block file before displaying reports. The reports can still be displayed without the user-defined function blocks, but the user-defined function block for that report will appear as a question mark (?), as shown below, and the contents cannot be checked.

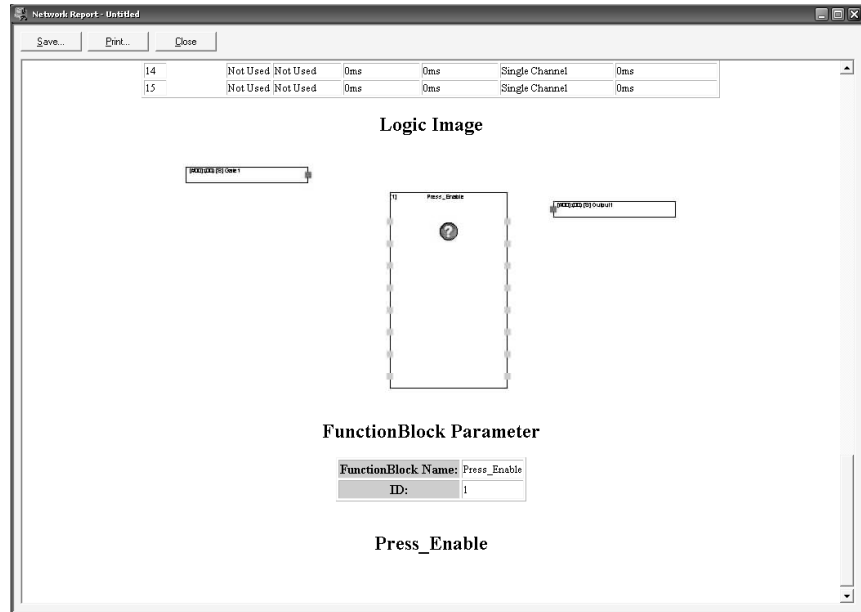

Verifying Programs

Always import the user-defined function block file before verification. Program verification can be completed even without user-defined function blocks once the program with user-defined function blocks is downloaded to the NE1A-series Controller, but the user-defined function block for that report will appear as a question mark (?) and the contents cannot be checked.

Editing Programs

Programs cannot be edited without the user-defined function block file. Always import the user-defined function blocks before editing. A warning message like the one shown below will appear if the Logic Editor is started without the user-defined function block file.

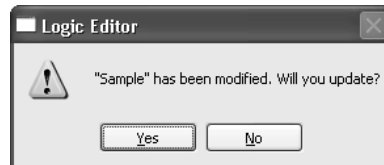

The following diagram shows how the program will appear if the Logic Editor is started in this status.

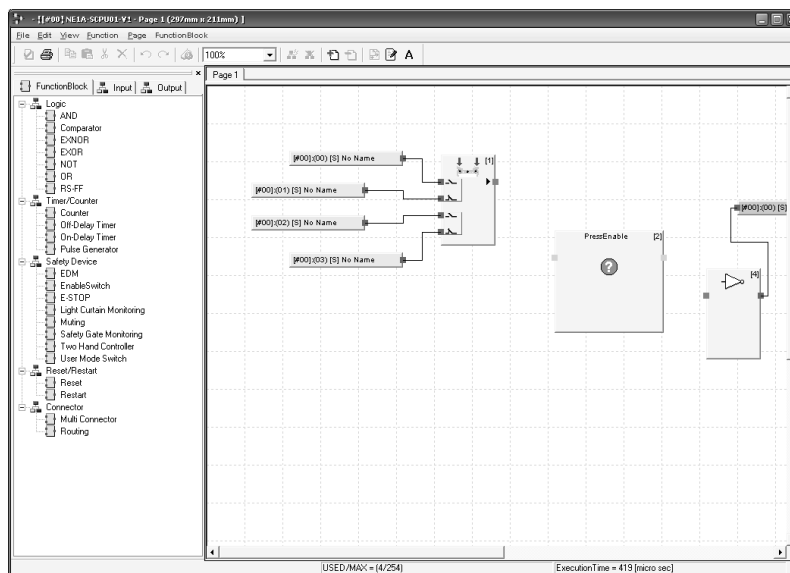

A user-defined function block without a file will appear as a question mark (?) and the connections will be deleted. Editing operations (copy, paste, undo, redo, etc.) cannot be used for the user-defined function block. Also, the program cannot be saved or downloaded after editing.

If the user-defined function block file is missing, import the user-defined function block. The program will not be automatically updated, however, if the user-defined function block is imported with the program open. Close the program and open it again to correctly display the user-defined function block.

The following table shows which functions require user-defined function block files and what will happen if the function is executed without the file.

Function	File	Operation
Download	Not required	Operates normally.
Upload	Not required	Operates normally.
Save project file	Not required	Operates normally.
Load project file	Not required	Operates normally.
Verify device	Required	The corresponding user-defined function block image will appear as a question mark (?).
Display report	Required	The corresponding user-defined function block image will appear as a question mark (?).
Edit program	Required	The Edit Program Screen will be displayed but the editing operations (copy, paste, undo, redo, etc.) cannot be executed.
Apply program	Required	Cannot be executed.

Editing User-defined Function Blocks After Creating a Program

This section describes how to edit user-defined function blocks after creating a program.

1. As shown in the following figure, right-click the function block or click the function block, and then right click. Select **Edit** when the menu is displayed.

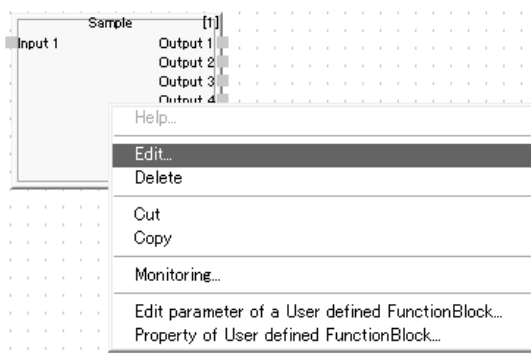

- The window for editing the user-defined function blocks will be displayed.
2. Perform the editing in the window for editing user-defined function blocks.

Note The following numbers of inputs and outputs cannot be changed when editing user-defined function blocks used in programming.

Numbers of I/O before editing	Numbers that can be used	Numbers that cannot be used
1 to 8	1 to 8	9 to 32
9 to 16	1 to 16	17 to 32
17 to 24	1 to 24	25 to 32
25 to 32	1 to 32	---

Programming User-defined Function Blocks

After editing a user-defined function block in other programming, the user can select whether to reflect the changes if programming that uses the same user-defined function block is started. The following section describes the procedure.

1. Click the **Edit** Button in the **Logic** Tab of the Edit Device Parameters Window of the NE1A-series Controller to start the Logic Controller. The following message will be displayed.

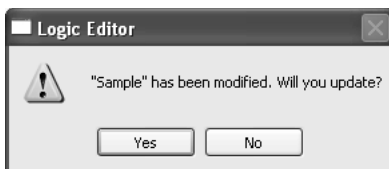

2. Click the **No** Button to no reflect the change. The corresponding user-defined function block will be indicated with a question mark (the same as if there is no file).

Click the **Yes** Button to reflect the change. The following message will be displayed.

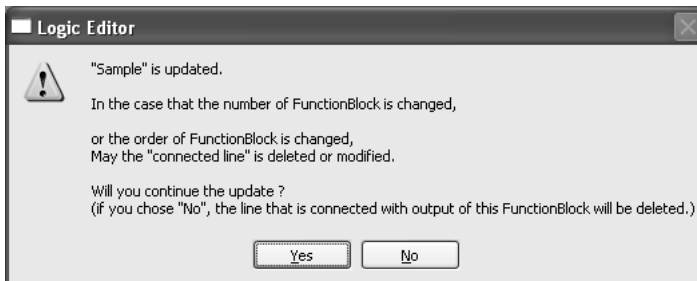

- When the **No** Button is clicked, the function blocks and connections connected to the outputs of the corresponding user-defined function block will be deleted, as in the following figure (output tags and connections to jump addresses will not be affected).

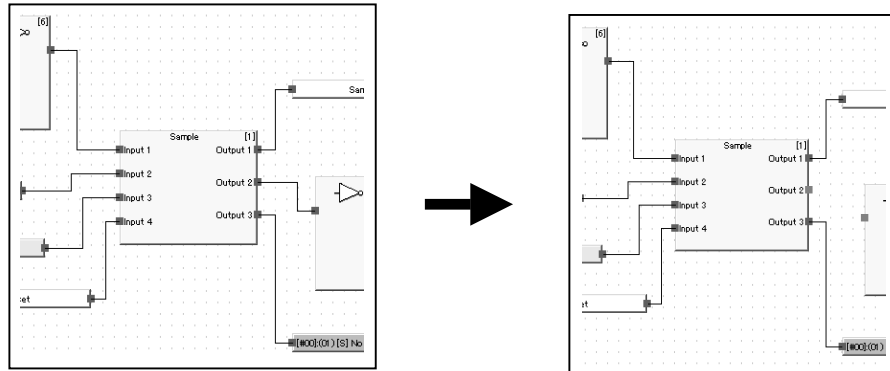

- If the **Yes** Button is clicked, changes to the user-defined function block file will be updated in the programming. If changes to the user-defined function block affect the function block execution sequence (e.g., newly adding or deleting parts of the function block), the user-defined function block outputs and the sequence of connections connected to function block inputs may be changed.

The following figure shows an example of the above. The figure at the left shows the condition before the changes.

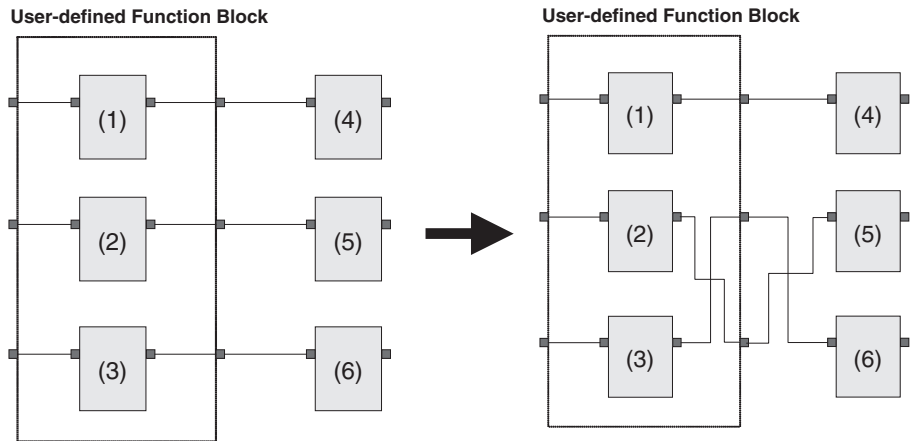

- Note**
- (1) Thoroughly check performance using the actual system after changing a user-defined function block that is used multiple times in the program.
 - (2) Start the Network Configurator as a user with administrator rights to import, save, delete, check, or edit user-defined function blocks.
 - On Windows XP, the above operations cannot be performed by a user that does not have administrator rights.
 - On Windows Vista or a later version, operations that are performed when the Network Configurator is started normally are not applied for other user accounts (including the administrator).

6-3-5 Password Protection for User-defined Function Blocks

Passwords can be set for user-defined function block files. The password protection applies to editing and deleting of user-defined function block files. Verify, Report, and Print operations are not password protected.

1. Select **File – Change Password**.
The Change Password Dialog Box will be displayed.

A screenshot of a 'Change Password' dialog box. The dialog box has a title bar with the text 'Change Password' and standard window control buttons (minimize, maximize, close). It contains three text input fields: 'Current Password', 'New Password', and 'Confirm Password'. At the bottom of the dialog box, there are two buttons: 'OK' and 'Cancel'.

2. Enter the password in the New Password field (up to 16 alphanumeric characters).
3. Re-enter the password in the Confirm Password field.
4. Click the **OK** Button.

The program password is now set.

From now on a dialog box requesting the password will be displayed whenever **Function Block – Edit** is selected from the function block list. Unless the set password is entered, the screen for creating user-defined function blocks will not be displayed and the function blocks cannot be edited.

The contents of user-defined function blocks can, however, be browsed. The program must be password protected to prevent browsing of user-defined function blocks (refer to *6-3-7 Password Protection for Programs*).

Note It is recommended that passwords be set for user-defined function blocks for which user tests have been completed so that unintentional changes are not made after the function block has been allocated in a program.

6-3-6 Saving the Program

Use the following procedure to save the program.

1. Select **File - Apply**.
The program is saved temporarily in the Network Configurator. The data is also saved temporarily in the same way when the user exits the Logic Editor.
2. After exiting the Logic Editor, click the **OK** Button in the Edit Device Parameters Dialog Box.

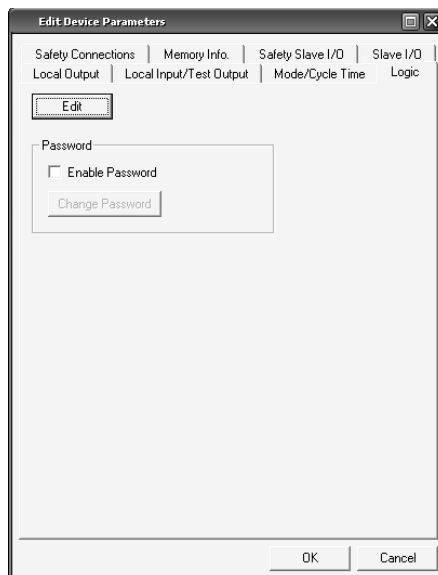

3. To save the file, select *File* and *Save* or *Save As* in the Main Window of the Network Configurator.

IMPORTANT

- To save the program and exit, the user must click the **OK** Button in the Edit Device Parameters Dialog Box when exiting the Logic Editor.
- If the user clicks the **Cancel** Button, none of the parameters entered until then, including the program, will be saved. Any programming saved temporarily by applying the program (selecting **File - Apply**) will also be deleted.

6-3-7 Password Protection for Programs

Passwords can be registered to protect editing, verification, and printing of programs.

Note There is no recovery mechanism if the program password is forgotten. When password-protecting programs, keep two copies of the network configuration file, one with a password and one without a password. Download the file with the password to the Safety Network Controller.

1. Select **Enable Password** on the Logic Tab Page of the Edit Device Parameters Dialog Box shown below.

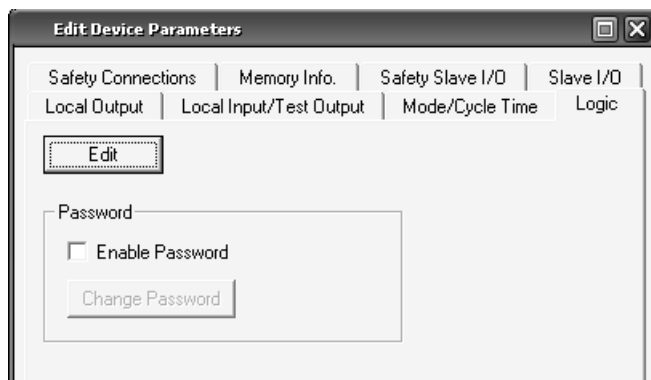

The Change Password Dialog Box will be displayed.



2. Enter the password in the New Password Field (up to 16 alphanumeric characters).
3. Re-enter the password in the Confirm Password Field.
4. Click the **OK** Button.

The program password is now set. A dialog box requesting the password will be displayed whenever the **Edit** Button is clicked to start the Logic Editor. Program edit/verification and report/print functions will not be available if the set password is not entered. Program can be uploaded and downloaded but the program contents cannot be displayed.

To change the password, click the **Change Password** Button on the Logic Tab in the Edit Device Parameters Dialog Box.

Note Passwords can be set only for programs created using version 1.3□ by clicking the **Edit** Button to start the Logic Editor first.

6-3-8 Updating the Program

If the I/O tags of the Safety Slaves that configure the NE1A-series Controller's local I/O and connections are changed (e.g., by adding or deleting I/O tags), the user must start the Logic Editor and check the program.

If the user downloads the parameters to the NE1A-series Controller without starting the Logic Editor, a download error will occur in the Logic Editor because of data inconsistency. If this error occurs, start the Logic Editor and check the program, making any required modifications.

6-3-9 Monitoring the Program

The I/O tag values and signal states of connections with function blocks can be monitored online in the Logic Editor Window. Make sure that the Network Configurator is connected to the network and that the NE1A-series Controller being monitored is in RUN state before starting online program monitoring.

Starting Online Monitoring

Start online monitoring using either of the following methods:

1. Select **Function - Monitoring** from the menu bar.
2. Click the **Monitoring** Button on the toolbar.

During monitoring, the I/O tags or connections that are ON will be displayed in a darker green color.

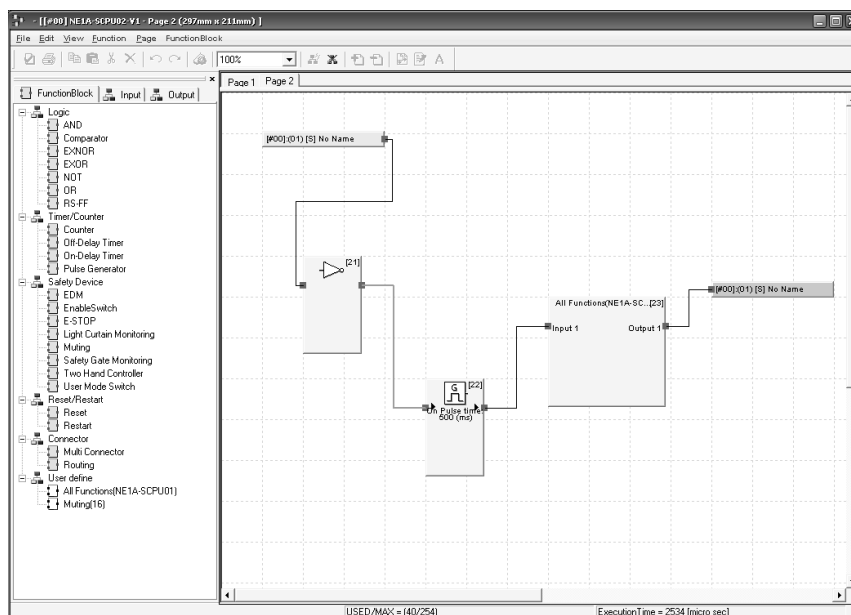

User-defined function block contents can be monitored.

Use the following procedure to start online monitoring.

1. Right-click the user-defined function block displayed on the screen and select **Monitoring** from the pop-up menu.

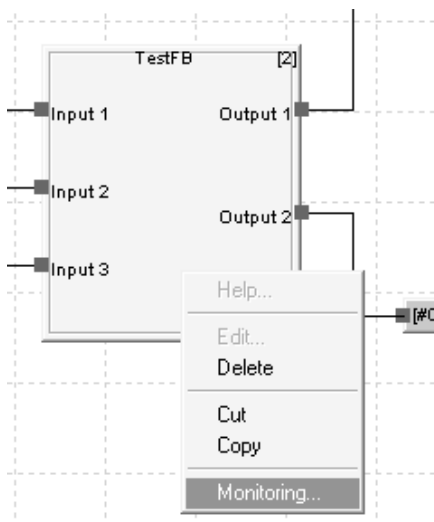

2. The Monitoring Screen will be displayed.
3. Click the **Monitoring** Button on the toolbar.
During monitoring, the I/O tags or connections that are ON will be displayed in dark green.

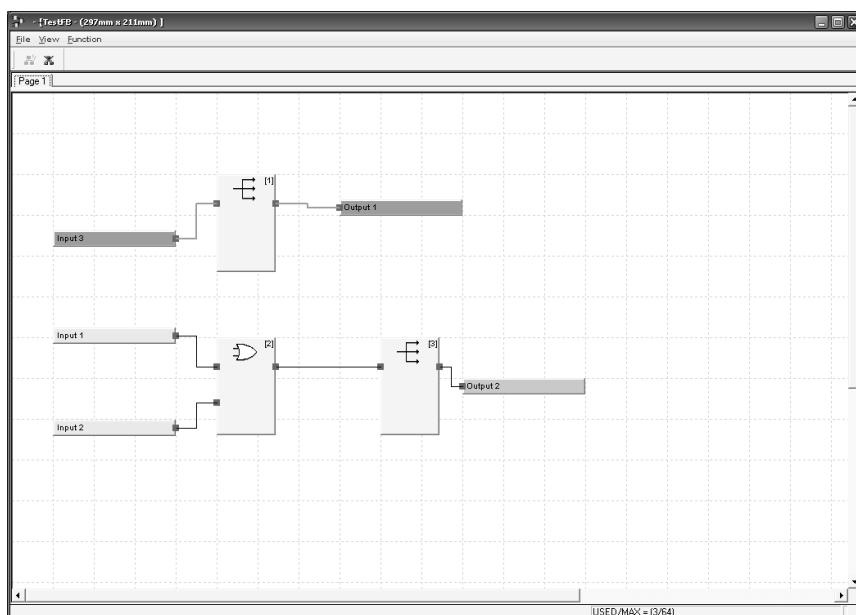

Stopping Online Monitoring

Click the **Stop Monitoring** Button on the toolbar to stop online monitoring.

Printing Programs

Programs can be printed.

1. Use one of the following methods to print the program
 - a. Select **File – Print** from the menu bar.
 - b. Click the **Print** Button on the toolbar.

The following dialog box will be displayed.

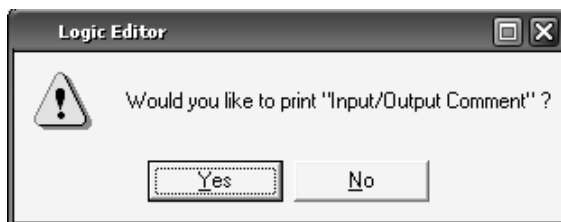

2. Click the **Yes** Button to also print the function block I/O comments when printing the program.

A Print Dialog Box like the one shown below will be displayed.

(The screen may differ depending on the printer set for the personal computer being used.)

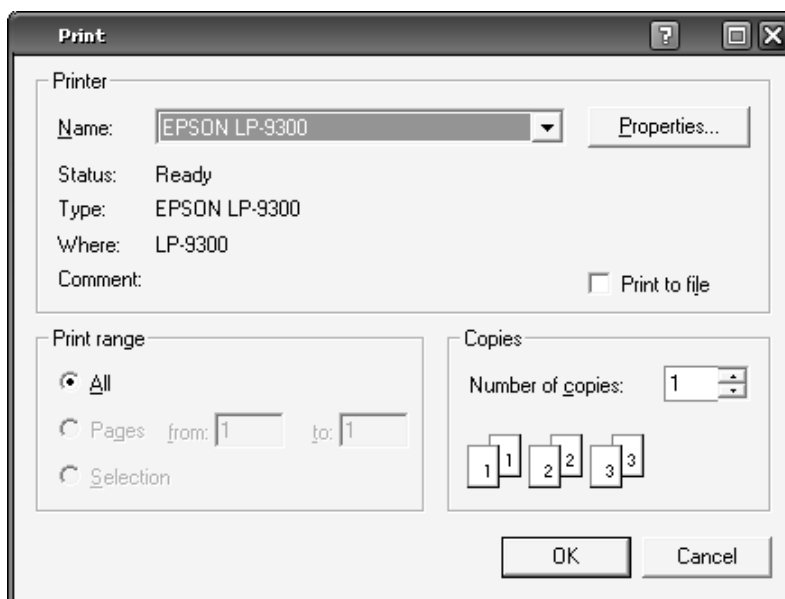

3. Click the **OK** Button.
The program will start printing.

Note The diagram frames will be printed with version 1.5□. Function blocks at the edges of program screens in data created using version 1.3□ may overlap with diagram frames when the program is printed. Do not place function blocks at the edges of the program screen.

Program Execution Sequence

The order of execution of function blocks is automatically set by the Logic Editor and displayed in the upper right corner of each function block. The execution order would be as follows in the following example:

- 1: E-STOP
- 2: Reset
- 3: EDM

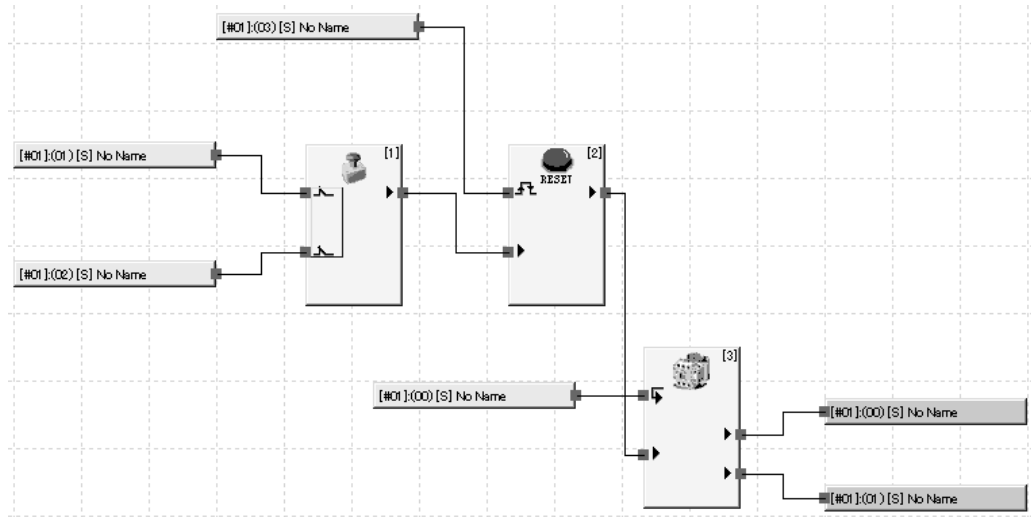

Execution Sequence of Programs with Loopbacks

Jump addresses can be used in programs to create loopbacks. If a program contains more than one loopback (e.g., Jump 1 to Jump 1 and Jump 2 to Jump 2 in the following example), the sequence of execution will be in the order that the function blocks are positioned. Carefully test all programs containing more than one loopback in the actual application to be sure they execute properly.

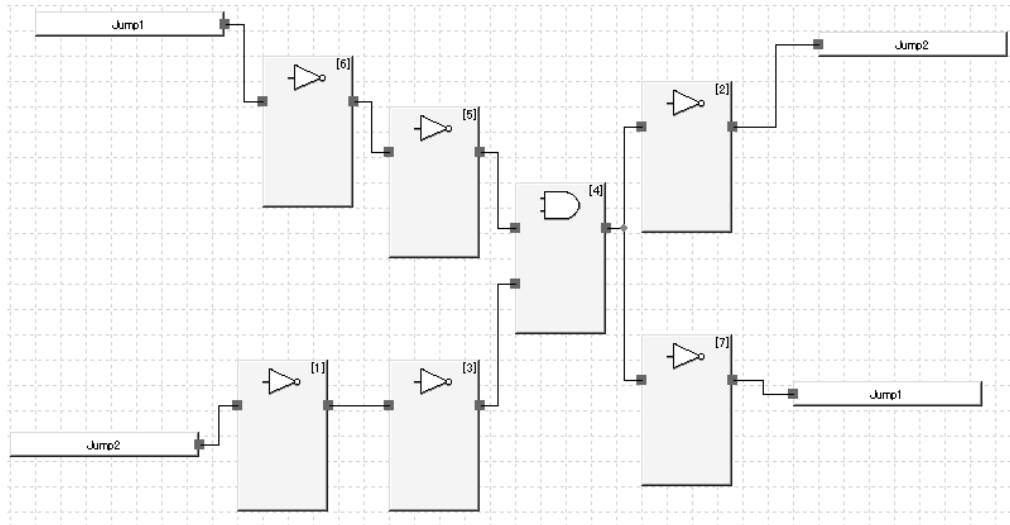

SECTION 7
Monitoring Devices

- 7-1 Monitoring Functions 218
 - 7-1-1 Monitoring Status 218
 - 7-1-2 Monitoring Safety Connections 220
 - 7-1-3 Monitoring Parameters 222
 - 7-1-4 Monitoring the Error History 224
- 7-2 Maintenance Functions (Unit Version 1.0 or Later) 227
 - 7-2-1 Total ON Time Monitor Function. 227
 - 7-2-2 Contact Operation Counter 230
- 7-3 Displaying Safety Device Status 233

7-1 Monitoring Functions

Devices supporting DeviceNet Safety hold a variety of status information internally. This information can be monitored using the Network Configurator.

7-1-1 Monitoring Status

Description

The status of NE1A-series or NE0A-series Controllers and DST1-series Safety I/O Terminals can be monitored using the Network Configurator. If an error occurs in a device, detailed information about the error can be accessed.

Monitoring Status Using the Network Configurator

The user can monitor the status using any of the following methods:

1. Select a device and select **Device - Monitor** from the menu bar. Click the **Status** Tab in the displayed window.
2. Select a device and click the **Monitor Device** Button on the toolbar. Click the **Status** Tab in the displayed window.
3. Right-click a device and select **Monitor** from the pop-up menu. Click the **Status** Tab in the displayed window.





Device Status

The device status is displayed.

Alarm/Warning

Errors and warning that have occurred in the device are displayed.

Click the **Detail** Button to identify the error. The  icon will be displayed for alarms and the  icon for warnings.

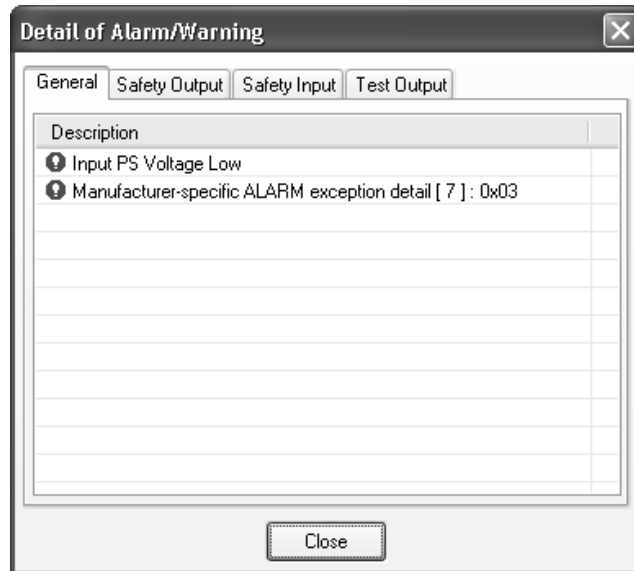

The Detail of Alarm/Warning Dialog Box has the following tab pages: General, Safety Output, Safety Input, and Test Output.

The General Tab Page displays the current Unit errors.

The other tab pages display errors occurring at the output terminal, the input terminal, and the test output terminal respectively. (The items displayed are outlined in *7-1-3 Monitoring Parameters*.)

If there is an alarm, the device will stop operation. Therefore the problem must be resolved.

If there is a warning, the device will continue to operate but the incident may develop into a problem. Therefore it is recommended that the cause of the warning is removed.

7-1-2 Monitoring Safety Connections

Description

The safety connection status of the NE1A-series Controller can be monitored using the Network Configurator. This enables the user to specify with which device an error is occurring in the safety communications and in which safety connection the error is occurring. Connection information of the DST1-series Safety I/O Terminals cannot be monitored.

Monitoring Using the Network Configurator

The user can monitor the safety connection status using any of the following methods:

1. Select the NE1A-series Controller and select **Device - Monitor** from the menu bar. Click the **Safety Connection** Tab in the displayed window.
2. Select the NE1A-series Controller and click the **Monitor Device** Button on the toolbar. Click the **Safety Connection** Tab in the displayed window.
3. Right-click the NE1A-series Controller and select **Monitor** from the pop-up menu. Click the **Safety Connection** Tab in the displayed window.

The connection status of the Safety Slave is displayed for the local node address. For the other node addresses, the status of the safety connections configured for the device parameters is displayed.

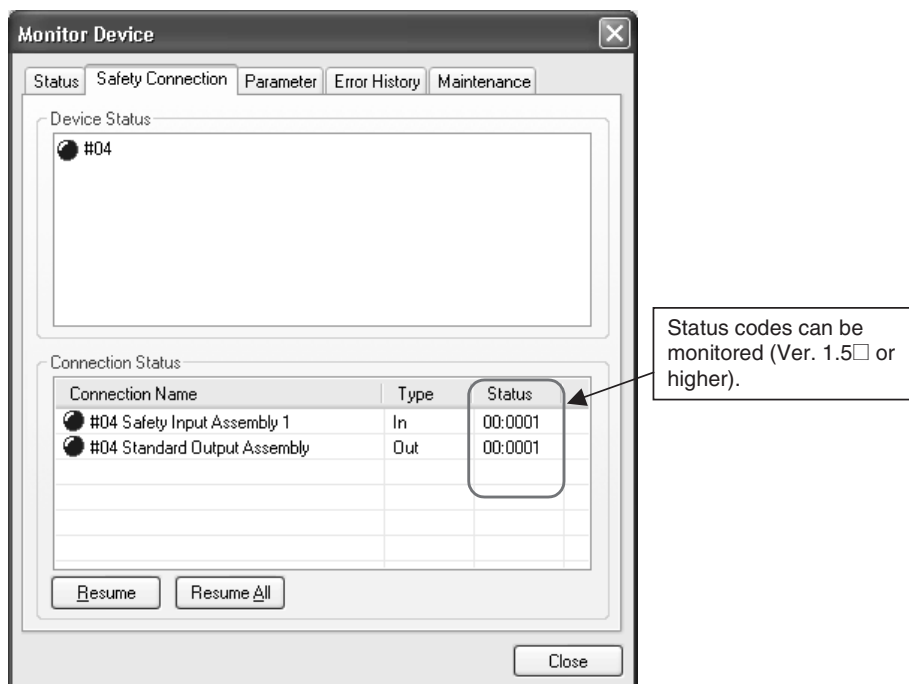

Status codes (error codes) can be monitored (version 1.5□ or higher).

This is useful when a connection cannot be established, because the status code returned by the target device can be used to check the cause of the error. Refer to *8-1 Connection Status Tables* for details of status codes.

The connection status of the Safety Slave is displayed for the local node address. For the other node addresses, the status of the safety connections configured for the device parameters is displayed.

Device Status

The connection status can be checked for each node address in the *Device Status* Field. The connection status is indicated by the following colors.

Color	Status
Gray	Unregistered device.
Green	All the connections are sending idle data.
Blue	All the connections are communicating normally.
Yellow	At least one connection is not connected or sending idle data. (An error has occurred and there is no connection.)
Red	An error has occurred in at least one connection.

For the local node address (i.e., the node address of the Safety Slave), the color gray indicates that there are no connections or that an error has occurred in a connection. The color blue indicates that normal communications are being performed in one or more connections.

Connection Status

The status can be checked for each safety connection in the *Connection Status* Field. The connection status is indicated by the following colors.

Color	Status
Gray	Connection is not connected.
Green	Idle data is being transmitted.
Blue	Normal communications are being performed.
Red	Connection error has occurred.

For the local node address (i.e., the node address of the Safety Slave), the color gray indicates that there is no connection or that an error has occurred in the connection. The color blue indicates normal communications.

7-1-3 Monitoring Parameters

Description

The I/O status of an NE1A-series or NEOA-series Controller or DST1-series Safety I/O Terminal can be monitored using the Network Configurator. If the configuration fails or if an error occurs in any I/O, monitoring this information enables the user to determine the cause of the error.

Monitoring Using the Network Configurator

The user can monitor the parameters using any of the following methods:

1. Select a device and select **Device – Monitor** from the menu bar. Click the **Parameters** Tab in the displayed window.
2. Select a device and click the **Monitor Device** Button on the toolbar. Click the **Parameters** Tab in the displayed window.
3. Right-click a device and select **Monitor** from the pop-up menu. Click the **Parameters** Tab in the displayed window.

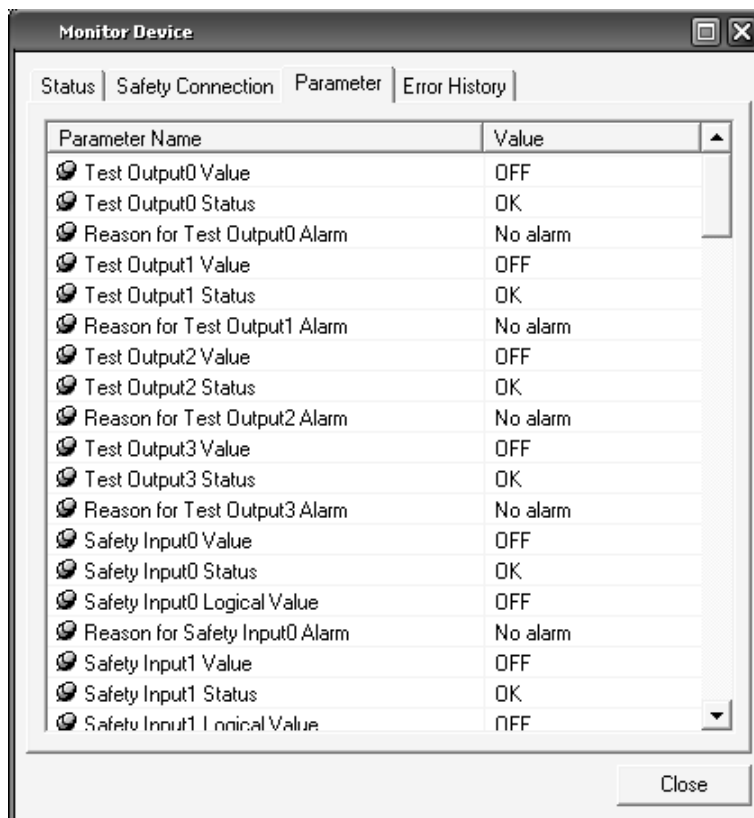

Test Output Terminal Status

Item	Description
Test Output Value	Output value of the test output.
Test Output Status	Evaluation result of the test output. "Alarm" is displayed if an error occurs.
Reason for Test Output Alarm	The cause of the error is displayed.

Safety Input Terminal Status

Item	Description
Safety Input Value	Input value to the safety input.
Safety Input Status	Evaluation result of the single-channel safety input. "Alarm" is displayed if an error occurs.
Safety Input Logical Value	This is the input value after the safety input terminal evaluation. "Off" is displayed if an error occurs.
Reason for Safety Input Alarm	The cause of the error is displayed.

Safety Output Terminal Status

Item	Description
Safety Output Value	Output value of the safety output.
Safety Output Monitor Value	Monitoring value of the output for the safety output.
Safety Output Status	Evaluation result of the single-channel safety output. "Alarm" is displayed if an error occurs.
Reason for Safety Output Alarm	The cause of the error is displayed.

For DST1-series Safety I/O Terminals, the following items will be displayed in addition to the above items.

Dual Channel Safety Input Status

Item	Description
Dual Channel Safety Input Evaluation	Evaluation result of the dual-channel safety input. "Alarm" is displayed if an error occurs.

7-1-4 Monitoring the Error History

Description

The error history of an NE1A-series or NE0A-series Controller or DST1-series Safety I/O Terminal can be monitored using the Network Configurator.

Twenty error history records can be saved internally in a Pre-Ver. 1.0 NE1A-series Controller, 100 records if the unit version is 1.0 or higher (including CPU Units that support EtherNet/IP), and ten records in a DST1-series Safety I/O Terminal. When the number of errors exceeds the number of records, the oldest records will be deleted.

Depending on the error type, some errors are saved in non-volatile memory and not cleared when the power is turned OFF. Other errors are saved in RAM and cleared when the power is turned OFF. Refer to the relevant operation manual for details.

Monitoring Using the Network Configurator

The user can monitor the error history using any of the following methods:

1. Select a device and select **Device – Monitor** from the menu bar. Click the **Error History** Tab in the displayed window.
2. Select a device and click the **Monitor Device** Button on the toolbar. Click the **Error History** Tab in the displayed window.
3. Right-click a device and select **Monitor** from the pop-up menu. Click the **Error History** Tab in the displayed window.

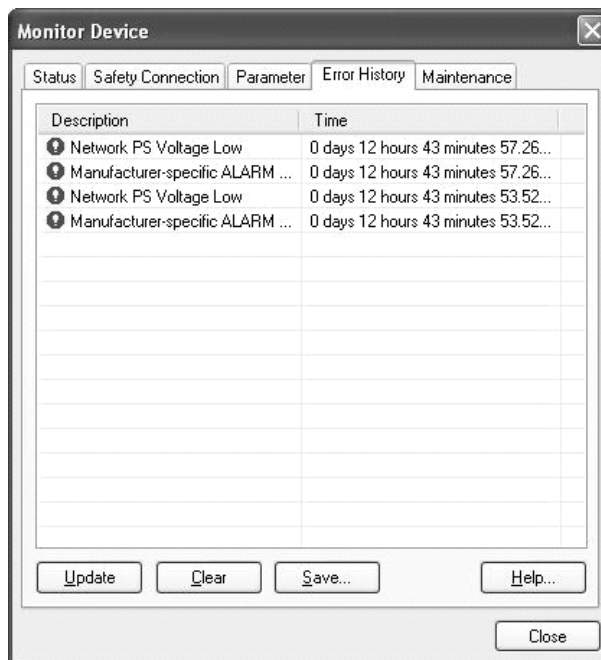

Error History Display Items

Item	Description
Description	Provides error details.
Time	The total device operation time when the error occurred.

Saving the Error History

The error history information can be saved in CSV format. Click the **Save** Button to save the information.

Clearing the Error History

Click the **Clear** Button to clear the error history saved internally in the NE1A-series or DST1-series Safety I/O Terminal.

Updating the Error History

Click the **Update** Button to access the most recent error history.

Displaying Countermeasures for Errors

It is possible to display countermeasures for errors. To display the countermeasures, double-click the error, or select the error and click the **Help** Button.

- Example of Countermeasure Display

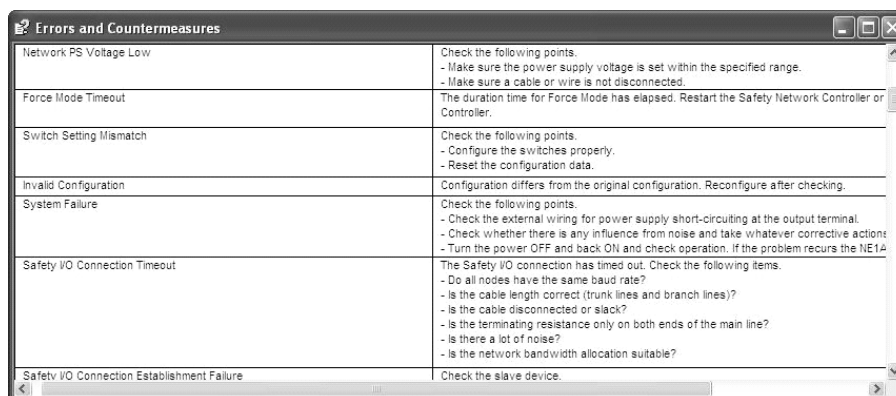

Using the Network Configurator to Monitor EtherNet/IP Error History (EtherNet/IP-compatible Units Only)

You can use any of the following methods to monitor the EtherNet/IP error history.

1. Select a device and then select Device - Monitor from the menu bar. Click the **EtherNet/IP Error History** Tab in the displayed window.
2. Select a device and then click the **Monitor Device** Button on the toolbar. Click the **EtherNet/IP Error History** Tab in the displayed window.
3. Right-click a device and select Monitor from the pop-up menu. Click the **EtherNet/IP Error History** Tab in the displayed window.

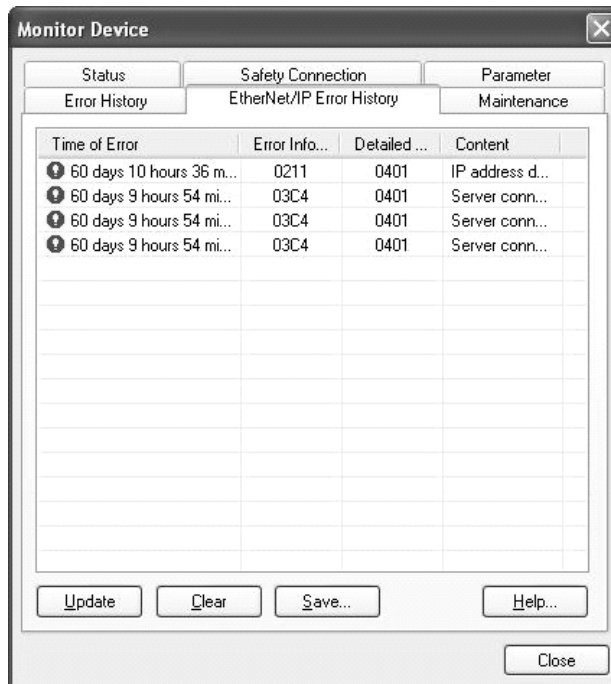

Error History Display Items

Item	Description
Time	The total device operation time when the error occurred.
Error information	Gives the error code.
Detailed information	Gives the detailed error code.
Contents	Displays the error contents.

Saving the Error History

The error history information can be saved in CSV format. Click the **Save** Button to save the information.

Clearing the Error History

Click the **Clear** Button to clear the error history saved internally in the NE1A-series or DST1-series Safety I/O Terminal.

Updating the Error History

Click the **Update** Button to access the most recent error history.

Displaying Countermeasures for Errors

It is possible to display countermeasures for errors. To display the countermeasures, double-click the error, or select the error and click the **Help** Button.

7-2 Maintenance Functions (Unit Version 1.0 or Later)

This section describes the maintenance functions of NE1A-series Controllers with version 1.0 or higher (including CPU Units that support EtherNet/IP).

7-2-1 Total ON Time Monitor Function

Overview

In NE1A-series Controllers with unit version 1.0 or later (including CPU Units that support EtherNet/IP), this function times how long a local input, test output, or local output is ON and stores that total ON time internally in non-volatile memory.

- Count range: 0 to 4,294,967,295 s
(stored as 00000000 to FFFFFFFF hex)
- Count units: Seconds

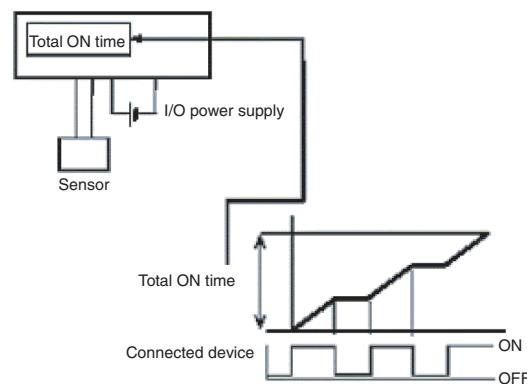

This information can be monitored using the Network Configurator or explicit messaging.

- Note**
- (1) The Total ON Time Monitor function (Time) and Contact Operation Counter function (Count) cannot be used simultaneously on one bit. Select one of these functions with the Maintenance Counter Mode Choice setting.
 - (2) When the Maintenance Counter Mode Choice setting is changed, the collected data (operations count or total ON time) will be cleared.
 - (3) These functions do not operate when the I/O power supply is OFF.
 - (4) The Total ON Time Monitor function checks whether the connected device is ON at about 1-s intervals. This function may not count the total ON time precisely if the device is ON for intervals of less than 1 second.

■ Calculating the Total ON Time with 0.5-s ON Pulses

In figure A, the bit is actually ON for $0.5 \text{ s} \times 3 = 1.5 \text{ s}$, but the bit is ON just once when the status is checked, so the total ON time is measured as 1 s.

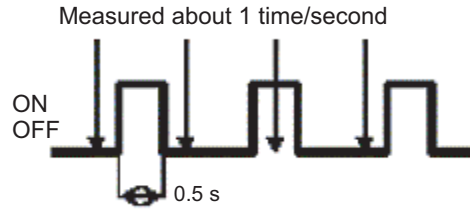

Figure A

In figure B, the bit is actually ON for $0.5\text{ s} \times 3 = 1.5\text{ s}$, but the bit is ON twice when the status is checked, so the total ON time is measured as 2 s.

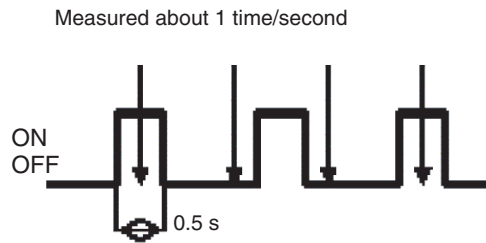

Figure B

■ **Calculating the Total ON Time with 1.5-s ON Pulses**

In figure C, the bit is actually ON for $1.5\text{ s} \times 2 = 3\text{ s}$, but the bit is ON four times when the status is checked, so the total ON time is measured as 4 s.

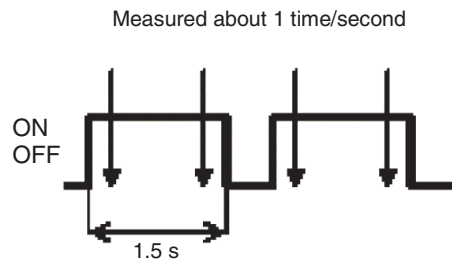
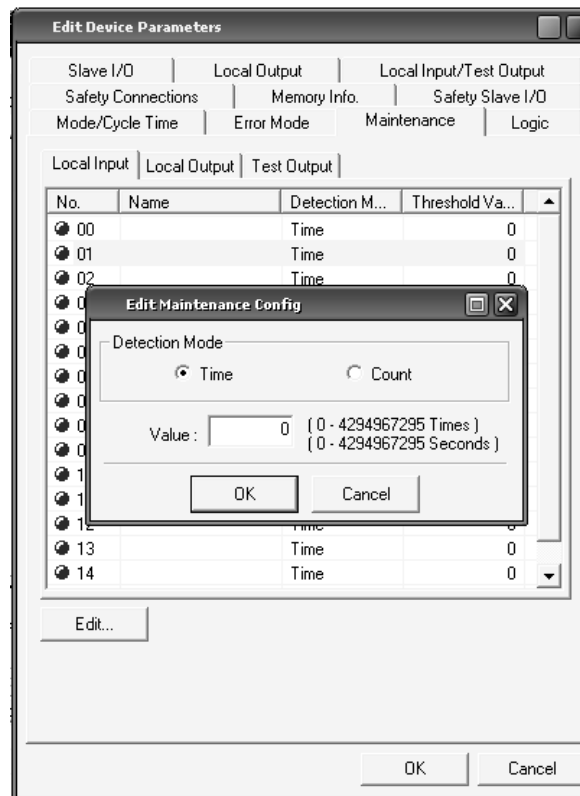

Figure C

Setting the Total ON Time Alarm Threshold with the Network Configurator

The maintenance mode (Maintenance Counter Mode Choice) and alarm threshold (Threshold Maintenance Counter) can be set for each local input, test output, and local output terminal.



If the alarm threshold (Threshold Maintenance Counter) is set to 0, the Controller will not compare the count or time PV to the alarm threshold SV.

Monitoring the Total ON Time from the Network Configurator

Any of the following methods can be used to monitor the total ON time in the local inputs, test outputs, or local outputs.

1. Select the device and select **Device – Maintenance information** from the menu bar.
2. Select the device and click the toolbar's **Maintenance** Button.
3. Select the device, right-click that device, and select **Maintenance information** from the popup menu.
4. Select the device, select **Device – Monitor** from the menu bar, and click the **Maintenance** Tab in the displayed window.
5. Select the device, click the toolbar's **Device Monitor** Button, and click the **Maintenance** Tab in the displayed window.
6. Select the device, right-click that device, select **Monitor** from the popup menu, and click the **Maintenance** Tab in the displayed window.

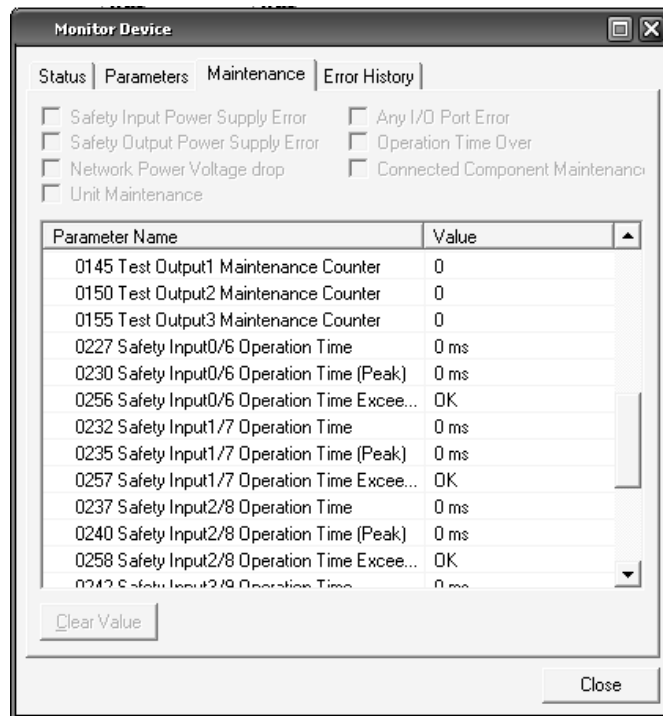

Each I/O point's accumulated total ON time can be cleared. To clear the time, select the total ON time to be cleared and click the **Clear Value** Button.

7-2-2 Contact Operation Counter

Overview

In Ver. 1.0 and later NE1A-series Controllers (including CPU Units that support EtherNet/IP), this function counts the number of OFF → ON operations at a local input, test output, or local output and stores the count internally in non-volatile memory.

- Count range: 0 to 4,294,967,295 operations (stored as 00000000 to FFFFFFFF Hex)
- Count units: Operations
- Resolution: Depends on the cycle time.

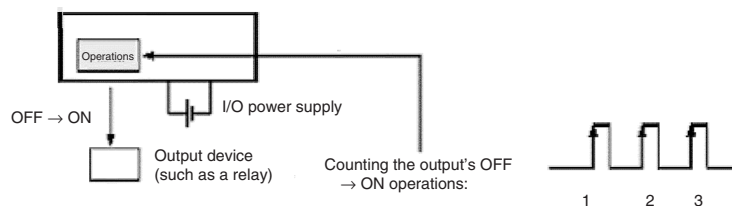

This information can be monitored using the Network Configurator or explicit messaging.

- Note**
- (1) The Contact Operation Counter function (Count) and Total ON Time Monitor function (Time) cannot be used simultaneously on one bit. Select one of these functions with the Maintenance Counter Mode Choice setting.
 - (2) When the Maintenance Counter Mode Choice setting is changed, the collected data (operations count or total ON time) will be cleared.
 - (3) These functions do not operate when the I/O power supply is OFF.

Setting the Contact Operations Alarm Threshold with the Network Configurator

The maintenance mode (Maintenance Counter Mode Choice) and alarm threshold (Threshold Maintenance Counter) can be set for each local input, test output, and local output terminal.

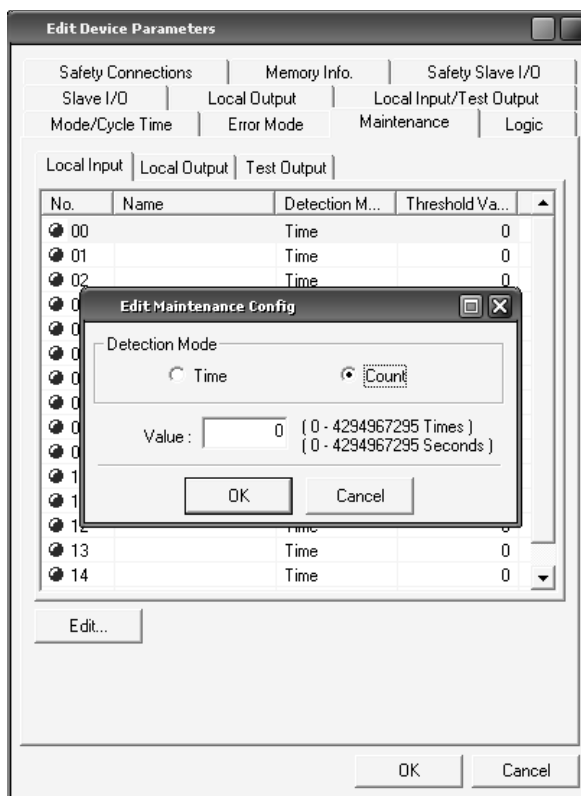

If the alarm threshold (Threshold Maintenance Counter) is set to 0, the Controller will not compare the count or time PV to the alarm threshold SV.

Monitoring Operations from the Network Configurator

Any of the following methods can be used to monitor the number of contact operations in the local inputs, test outputs, or local outputs.

1. Select the device and select **Device – Maintenance information** from the menu bar.
2. Select the device and click the toolbar's **Maintenance** Button.
3. Select the device, right-click that device, and select **Maintenance information** from the popup menu.
4. Select the device, select **Device – Monitor** from the menu bar, and click the **Maintenance** Tab in the displayed window.
5. Select the device, click the toolbar's **Device Monitor** Button, and click the **Maintenance** Tab in the displayed window.
6. Select the device, right-click that device, select **Monitor** from the popup menu, and click the **Maintenance** Tab in the displayed window.

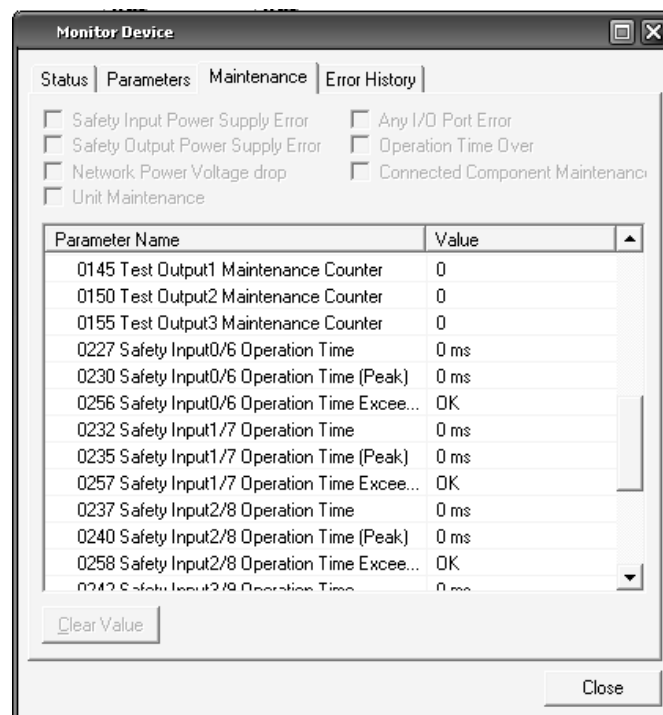

Each I/O point's accumulated contact operations count can be cleared. To clear the count, select the contact operations count to be cleared and click the **Clear Value** Button.

7-3 Displaying Safety Device Status

Device Status Display

Safety information for safety devices (NE1A-SCPU and DST1 Series) can be displayed in Maintenance Mode. An example is shown below.

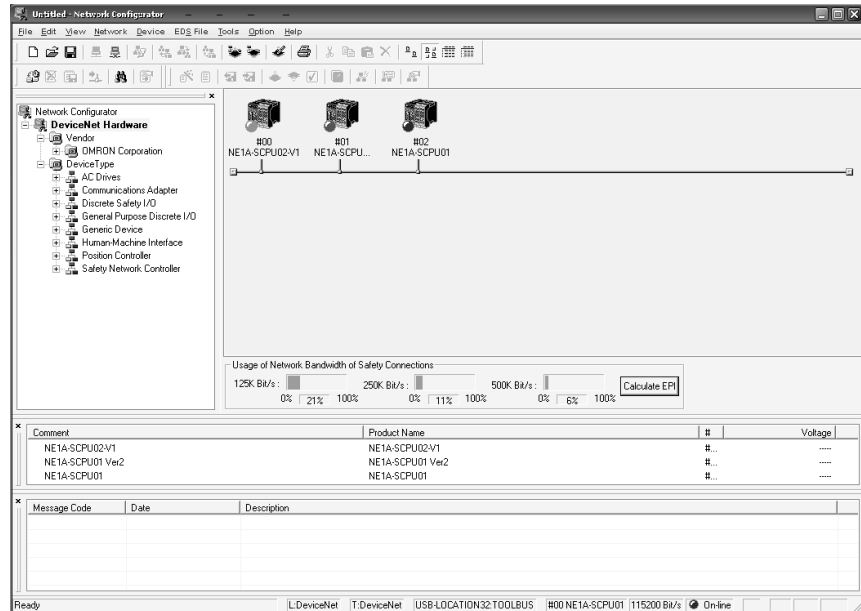

Moving to Maintenance Mode

The icons that appear in the Maintenance Mode display indicate the status shown in the following table.

Icon (diagram)	Status
Gray with white border	Offline
Gray with green border	Default status (Not set in configuration.)
Green	Idle state
Blue	Normal execution
Yellow	Warning
Red	Alarm

Updating Device Status Displays

Device status displays are automatically updated when the following operations are executed using the Network Configurator.

- Uploading networks
- Downloading networks
- Downloading parameters
- Updating maintenance information
- Uploading device modes (RUN/IDLE)
- Resetting devices

In addition, while online, the display can be updated at any time by selecting **Network –Update Device Status**.

Automatic Updates of Device Status Displays

When the Network Configurator is connected to the system and online, device information can be automatically acquired and the status displayed. To have device status updated and displayed automatically when an online connection is made, select **Options – Update Device Status automatically, when it was connected on Network.**

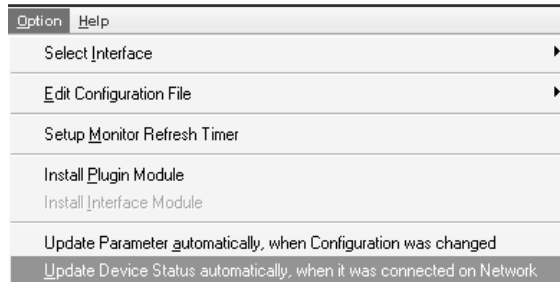

SECTION 8

Troubleshooting

8-1	Connection Status Tables	236
8-1-1	Outline	236
8-1-2	Connection Status for DST1 Series	236
8-1-3	Connection Status for the NE1A-series Controller (Safety Slave Function)	238
8-2	Errors When Downloading	241
8-2-1	Outline	241
8-2-2	Error Messages and Countermeasures	241
8-3	Errors When Resetting	244
8-3-1	Outline	244
8-3-2	Error Messages and Countermeasures	244
8-4	Errors When Changing Modes	245
8-4-1	Outline	245
8-4-2	Error Messages and Countermeasures	245
8-5	Errors That Can Be Found Using the Connection Check Function	246
8-5-1	Outline	246
8-5-2	Display Messages and Countermeasures	246

8-1 Connection Status Tables

8-1-1 Outline

If an error occurs when the NE1A-series Controller tries to establish a safety connection with an NE0A-series Controller, DST1-series Safety I/O Terminal or an NE1A-series Controller set as a Slave, the 7-segment display will display the error codes d6, dA, or d5.

Check the status code (error code) shown on the Safety Connection Tab Page in the Monitor Device Window and take the corresponding countermeasure.

8-1-2 Connection Status for DST1 Series

Status		Countermeasure
00:0001	Normal communications	The Safety I/O connection status is normal.
01:0001	Safety I/O Connection Timeout	The Safety I/O connection has timed out. Check the following items. <ul style="list-style-type: none"> • Do all nodes have the same baud rate? • Is the cable length correct (trunk lines and branch lines)? • Is the cable disconnected or slack? • Is the terminating resistance only on both ends of the main line? • Is there a lot of noise? • Is the network bandwidth allocation suitable?
01:0105	Configuration Owner Error	The Safety Slave was configured from a configuration tool or Safety Master at a different node address last time. Reset the Safety Slave to the default settings and download the device parameters again. Refer to <i>5-1-2 Setting Safety Connection Parameters</i> for information on configuration owners.
01:0106	Output Connection Owner Error	The Safety Slave established output safety I/O connections with a Safety Master at a different node address last time. Reset the Safety Slave to the default settings and download the device parameters again. Refer to <i>5-1-2 Setting Safety Connection Parameters</i> for information on output connection owners.
01:0110	Device Not Configured	The Safety Slave has not been configured. Download the device parameters to the Safety Slave.
01:0113	No. of Connections Error	The setting for the number of safety I/O connections exceeds the upper limit supported by the Safety Slave. Adjust the Safety Connection setting for the relevant Safety Master.
01:0114	Vendor ID or Program Code Error	The device data (vendor ID or product code) for the device on the Configurator and the device used in the actual system does not match. <ul style="list-style-type: none"> • Use Safety Slave Verification (Device - Parameter - Verify) to check that the device in the system and the device registered to the Safety Master match. • If they do match, delete then re-register the connections registered to the Safety Master.
01:0115	Device Type Error	The device data (device type) for the device on the Configurator and the device used in the actual system does not match. <ul style="list-style-type: none"> • Use Safety Slave Verification (Device - Parameter - Verify) to check that the device in the system and the device registered to the Safety Master match. • If they do match, delete then re-register the connections registered to the Safety Master.
01:0116	Revision Error	The device data (revision) for the device on the Configurator and the device used in the actual system does not match. <ul style="list-style-type: none"> • Use Safety Slave Verification (Device - Parameter - Verify) to check that the device in the system and the device registered to the Safety Master match. • If they do match, delete then re-register the connections registered to the Safety Master.

Status		Countermeasure
01:0117	Connection Path Error	<p>1. Two or more output safety I/O connections have been set for the Safety Slave.</p> <ul style="list-style-type: none"> • Change the Safety Connection setting for the Safety Master so there is only one connection. Then reset the Safety Slave to default settings and download the device parameters to the Safety Slave again. <p>2. The same output assembly number for a Safety Slave has been used for both a Safety Master and a Standard Master.</p> <ul style="list-style-type: none"> • Input assembly numbers can be duplicated but output assembly numbers cannot. Check the Safety Connection setting for both the Safety Master and the Standard Master then return the Safety Slave to default settings and download the device parameters to the Safety Slave again. • If the error remains even after the above countermeasure has been performed, delete and re-register the connections registered to the Safety Master.
01:0119	Unable to communicate with Safety I/O	The DST1-XD□□ Safety Slave is set to Auto Execution Mode. In this mode, the Controller cannot establish Safety I/O communications with the Safety Slave. Change the mode to After Establishing Safety I/O Connection.
01:0204	Communications with Safety Slave timed out	<p>It may not be possible to communicate with the Safety Slave.</p> <p>Check the status of the Safety Slave to see if it is online (the NS indicator should be flashing or lit green). If the Safety Slave is online, check the following items.</p> <ul style="list-style-type: none"> • Make sure that the Safety Slave's node address is correct. • Make sure that all nodes are set to the same baud rate. • Make sure that all cable lengths (main and branch lines) are suitable. • Make sure that the cable is not broken or loose between the Safety Master and Safety Slave. • Make sure that terminating resistance has been connected only at the ends of the main line. • Make sure that there is not excessive noise affecting communications.
01:031E	No. of Connections Error	The setting for the number of safety I/O connections exceeds the upper limit supported by the Safety Slave. Adjust the Safety Connection setting for the relevant Safety Master. In particular, check that no more than 15 Safety Masters are set for each Multi-cast connection, with a maximum total of 30.
01:031F	Connection ID Resource Error	<p>The maximum number of connection IDs for one Safety Master (12) has been exceeded.</p> <p>Change the ID allocation under Edit Safety Connection – Expansion Connection Setting to “Check Produced IDs in the Safety Slave” in the corresponding Safety I/O Connection (Safety Input Assembly) setting, then download the device parameters to the Safety Master again.</p>
01:07FF	Non-existent Safety Slave	<p>The Safety Slave may not have been added to the network correctly. Check that the corresponding Safety Slave is online (i.e., the NS indicator is flashing green or lit green.) If the Safety Slave is not online, check the following items.</p> <ul style="list-style-type: none"> • Is the node address for the Safety Slave correct? • Do all nodes have the same baud rate? • Is the cable length correct (trunk lines and branch lines)? • Is the cable disconnected or slack? • Is the terminating resistance only on both ends of the main line? • Is there a lot of noise?
01:080C	Safety Signature Mismatch	<p>The safety signature for the Safety Slave monitored by the Safety Master does not match the safety signature of the Safety Slave itself.</p> <ul style="list-style-type: none"> • Reset the Safety Slave to default settings then download the device parameters again. • If the above remedy does not work, delete then re-register the connections registered to the Safety Master.

Status		Countermeasure
01:080E	TUNID Mismatch	The TUNID for the Safety Slave monitored by the Safety Master does not match the TUNID of the Safety Slave itself. <ul style="list-style-type: none"> • Reset the Safety Slave to default settings then download the correct device parameters. • If the above remedy does not work, delete then re-register the connections registered to the Safety Master. Refer to <i>3-5-2 Network Numbers</i> for information on TUNIDs.
01:080F	Safety Configuration not possible	1. The Safety Slave is configuration locked and <i>Configure the target device</i> is selected for the Open Type setting for the Safety Master connection. <ul style="list-style-type: none"> • Release the configuration lock on the Safety Slave to configure the Safety Slave from the Safety Master. • To configure the Safety Slave from a configuration tool, set the Safety Master connection to <i>Check the safety signature</i> under Open Type. Then reset the Safety Slave to default settings and download the device parameters to the Safety Slave again. 2. The <i>Open Type</i> of the Safety Master connection is set to Configure the Safety Slave when the execution mode of the DST1-XD□□ Safety Slave is set to Auto Execution mode. <ul style="list-style-type: none"> • When the DST1-XD□□ is set to Auto Execution mode, it cannot establish Safety I/O communications. Change the setting to <i>After Establishing Safety I/O Connection</i>.
D0:0001	IDLE mode	The NE1A-series Safety Master is in IDLE mode, and has not started safety I/O communications. Change the operating mode to RUN mode.

8-1-3 Connection Status for the NE1A-series Controller (Safety Slave Function)

Status		Countermeasure
00:0001	Normal communications	The Safety I/O connection status is normal.
01:0001	Safety I/O Connection Timeout	The Safety I/O connection has timed out. Check the following items. <ul style="list-style-type: none"> • Do all nodes have the same baud rate? • Is the cable length correct (trunk lines and branch lines)? • Is the cable disconnected or slack? • Is the terminating resistance only on both ends of the main line? • Is there a lot of noise? • Is the network bandwidth allocation suitable?
01:0106	Output Connection Owner Error	The Safety Slave established an output safety I/O connection with a Safety Master with a different node address last time. Reset the Safety Slave to the default settings and download the device parameters again. Refer to <i>5-1-2 Setting Safety Connection Parameters</i> for information on output connection owners.
01:0109	Data Size Error	The Safety Slave I/O size set to the NE1A-series Controller Safety Slave and the size set under the Safety Master safety connection setting does not match. The Safety Slave I/O setting may have been changed, so delete then re-register the connections registered to the Safety Master.
01:0110	Unconfigured Device	The Safety Slave has not been configured. Download the device parameters to the Safety Slave.
01:0111	EPI Error	The EPI set under the Safety Master safety connection setting is smaller than the Safety Slave cycle time. The EPI must be longer than both the Safety Master and the Safety Slave cycle times. Check the Safety Master safety connection setting.
01:0113	No. of Connections Error	The setting exceeds the maximum number of safety I/O connections supported by the Safety Slave. Check the relevant Safety Master safety connection settings.

Status		Countermeasure
01:0114	Vendor ID or Product Code Error	The device data (vendor ID or product code) for the device on the Configurator and the device used in the actual system does not match. <ul style="list-style-type: none"> • Use Safety Slave Verification (Device - Parameter - Verify) to check that the device in the system and the device registered to the Safety Master match. • If they do match, delete then re-register the connections registered to the Safety Master.
01:0115	Device Type Error	The device data (device type) for the device on the Configurator and the device used in the actual system does not match. <ul style="list-style-type: none"> • Use Safety Slave Verification (Device - Parameter - Verify) to check that the device in the system and the device registered to the Safety Master match.
01:0116	Firmware Revision Error	The device data (firmware revision) for the device on the Configurator and the device used in the actual system does not match. <ul style="list-style-type: none"> • Use Safety Slave Verification (Device - Parameter - Verify) to check that the device in the system and the device registered to the Safety Master match. • If they do match, delete then re-register the connections registered to the Safety Master.
01:0117	Connection Path Error	Two or more single-cast safety I/O connections or a multi-cast safety I/O connection with a different EPI has been set for a safety slave I/O. <ul style="list-style-type: none"> • To share one safety slave I/O on a Safety Slave with more than one Safety Master, make the EPI all the same and set the connection type to Multi-cast. • NE1A-series Controller Safety Slaves cannot have more than one single-cast safety I/O connection for each Safety Slave I/O. Set multiple connection paths for the NE1A-series Safety Slave Safety Slave I/O. • If the connection is not restored with the above remedy, delete then re-register the connections registered to the Safety Master.
01:031E	No. of Connections Error	The setting for the number of safety I/O connections exceeds the upper limit supported by the Safety Slave. Adjust the Safety Connection setting for the relevant Safety Master. In particular, check that no more than 15 Safety Masters are set for each Multi-cast connection, with a maximum total of 60.
01:031F	Connection ID Resource Error	The maximum number of connection IDs for one Safety Master (12) has been exceeded. Change the ID allocation under Edit Safety Connection – Expansion Connection Setting to “Check Produced IDs in the Safety Slave” in the corresponding Safety I/O Connection (Safety Input Assembly) setting, then download the device parameters to the Safety Master again.
01:07FF	Non-existent Safety Slave	The Safety Slave may not have been added to the network correctly. Check that the corresponding Safety Slave is online (i.e., the NS indicator is flashing green or lit green.) If the Safety Slave is not online, check the following items. <ul style="list-style-type: none"> • Is the node address for the Safety Slave correct? • Do all nodes have the same baud rate? • Is the cable length correct (trunk lines and branch lines)? • Is the cable disconnected or slack? • Is the terminating resistance only on both ends of the main line? • Is there a lot of noise?
01:080C	Safety Signature Mismatch	The safety signature for the Safety Slave monitored by the Safety Master does not match the safety signature of the Safety Slave itself. <ul style="list-style-type: none"> • Reset the Safety Slave to default settings then download the device parameters again. • If the above remedy does not work, delete then re-register the connections registered to the Safety Master.
01:080E	TUNID Mismatch	The TUNID for the Safety Slave monitored by the Safety Master does not match the TUNID of the Safety Slave itself. <ul style="list-style-type: none"> • Reset the Safety Slave to default settings then download the correct device parameters. • If the above remedy does not work, delete then re-register the connections registered to the Safety Master. Refer to 3-5-2 Network Numbers for information on TUNIDs.

Status		Countermeasure
OC:0002	The Safety Slave is in IDLE mode	The NE1A-series Controller operating as a Safety Slave is in IDLE mode, and safety I/O connection cannot be established. Change the operating mode to RUN mode.
D0:0001	IDLE Mode	The NE1A-series Controller that is the Safety Master (d6/b6 is displayed) is in IDLE mode, and has not started a safety I/O connection. Change the NE1A-series Safety Master operating mode to RUN mode.

8-2 Errors When Downloading

8-2-1 Outline

The NE1A-series Controller, NE0A-series Controller, or DST1-series or other Safety Devices may return an error when configuration data is downloaded to them. The cause of the error can be determined from the error information displayed on the Network Configurator.

8-2-2 Error Messages and Countermeasures

Message displayed on the Network Configurator	Countermeasure
Object state conflict.	A fatal error (Abort) (MS indicator flashes red) has occurred. Set the switches correctly or execute reset (return to default settings and restart) to clear the configuration data.
The device is locked.	The configuration data is locked. (LOCK indicator is lit.) Release the lock.
The TUNID not matched.	<p>The device is waiting for a TUNID setting after being reset (NS indicator is flashing green/red) or the TUNID of the Network Configurator is different from the device when downloading. Use the following steps to check the setting.</p> <ol style="list-style-type: none"> 1. Reset the device to default settings then download the parameters again. The network number may, however, be different from other devices. If the NE1A-series Controller 7-segment display shows "d6" (A <i>Safety I/O Connection Establishment Failure</i> message appears on the Error History Tab Page in the Network Configurator Monitor Device Window) after the operating mode has been changed, use steps (2) or (3) to correct the error. 2. Select Network – Upload in the Network Configurator. Unify the network numbers and reset all devices to the default settings. Once reset, download the parameters to all devices again. 3. Select Network – Property to display the Network Property Dialog Box in Network Configurator then click the Get from Network Button in the Network Number Field. If there are multiple network numbers, select one of these numbers to unify all to that network number.
Privilege violation.	The password used does not provide authority to change configurations. Check that the correct password is being used.
	An attempt was made to disable the DeviceNet communications (standalone) via DeviceNet. Connect the Network Configurator by USB and download the data again. (With Controllers that support EtherNet/IP, this is also possible via EtherNet/IP.)
Device state conflict.	Downloading from more than one Network Configurator at the same time. Wait until other downloads have been completed.

Message displayed on the Network Configurator	Countermeasure
<p>The error occurred in the validation of a device parameter.</p>	<p>There is a non-alignment between configuration parameters. Check the following items and change the parameters.</p> <ul style="list-style-type: none"> • The time parameters (e.g., Discrepancy Time) set for function blocks in the NE1A-series Controller settings are shorter than the NE1A-series Controller cycle time. • The safety connection EPI is shorter than the cycle time. • The safety inputs are set to <i>Test pulse from test out</i> but the test source has not been set. • One of the safety inputs in a dual channel setting is set as a standard input and the other has a different setting. • One of the safety inputs in a dual channel setting is set to <i>Not Use</i> and the other has a different setting. • One of the safety outputs in a dual channel setting is set to <i>Not Use</i> and the other has a different setting. • The maximum number of connection IDs for one Safety Master (12) has been exceeded in the safety I/O configuration. Change the ID allocation under Edit Safety Connection - Expansion Connection Setting to "Check Produced IDs in the Safety Slave" in the corresponding Safety I/O Connection (Safety Input Assembly) setting, then download the device parameters to the Safety Master again. <p>The program may have been created with an earlier Network Configurator than version 1.5□. The checks for safety functions have been improved in version 1.5□ so programs created in an earlier version of the NE1A-series Controller cannot be downloaded as is. Use the following procedure to convert the program and then download the program again.</p> <ol style="list-style-type: none"> 1. Click the Edit Button on the Logic Tab page in the Edit Device Parameters Window of the NE1A-series Controller to open the Logic Editor. 2. Select Edit – Find Function Blocks with Open Connections to check all function block I/O are connected. For information on open function block connections, refer to <i>Precautions Updating from Network Configurator Version 1.3@ to a Higher Version</i> on page xxxi. 3. Select File – Apply to save the logic program then close the Logic Editor. 4. Return to the NE1A-series Controller's Edit Device Parameters Window and click the OK Button. <p>The hardware may be malfunctioning. Cycle the NE1A-series Controller power and execute self-diagnosis. If the MS indicator is lit red, replace the hardware.</p>
<p>Logic Editor: Consistency Error.</p>	<p>The network configuration has changed, which has resulted in a non-alignment between the logic program data and other data. Start Logic Editor and check changed I/O locations and make the settings again.</p>
<p>Device can not be accessed.</p>	<p>Device is waiting for a TUNID setting (NS indicator is flashing green/red) after reset was executed from another node during download. Set the TUNID and download again.</p> <p>Refer to <i>3-5-2 Network Numbers</i> for information on TUNIDs.</p> <p>With Controllers that support EtherNet/IP, use the DeviceNet Network Window for downloads. Downloads cannot be executed from the EtherNet/IP Network Window.</p>

Message displayed on the Network Configurator	Countermeasure
Connection can not be opened.	<p>1. Could not establish connection with device when downloading to the device via DeviceNet. Check that the power is ON to the device and download again.</p> <p>2. The connection resources available for the device are being used to establish safety I/O connections with the Safety Master, so a connection cannot be established with the Network Configurator. Change the operating mode of the Safety Master to which the safety connections are registered to IDLE mode.</p> <p>3. If the above causes do not apply, noise or other factors may be making communications unstable. Check the following items.</p> <ul style="list-style-type: none"> • Do all nodes have the same baud rate? • Is the cable length correct (trunk lines and branch lines)? • Is the cable disconnected or slack? • Is the terminating resistance only on both ends of the main line? • Is there a lot of noise?
Sending message failed.	Downloaded via USB to the device but could not connect to the device. Check that the power is turned ON to the device and download again.
Connection failed.	<p>Tried to configure a device on the DeviceNet network via the NE1A-series Controller USB port, but connection failed. Check that power is turned ON to the device and download again.</p> <p>If the above cause does not apply, noise or other factors may be making communications unstable. Check the following items.</p> <ul style="list-style-type: none"> • Do all nodes have the same baud rate? • Is the cable length correct (trunk lines and branch lines)? • Is the cable disconnected or slack? • Is the terminating resistance only on both ends of the main line? • Is there a lot of noise?
In order to configure the device, the device needs to be reset. Because, the device is configured by another device.	<p>The Safety Slave was configured from a Safety Master last time (see note). Reset the Safety Slave to default settings and download the device parameters again.</p> <p>Note: 5-1-2 <i>Setting Safety Connection Parameters</i> for information on configuration from Safety Masters.</p>
Logic is incomplete. Please confirm logic.	<p>There are open inputs or outputs in a function block used in the logic program. Click the Edit Button on the Logic Tab Page to open the logic and perform the following measures.</p> <ul style="list-style-type: none"> • Connect the open inputs or outputs. • Change the number of I/O setting for the function block to delete the open input or output. <p>Function blocks with open inputs or outputs can be searched by using Edit – Find Function Blocks with Open Connections. For details, refer to <i>Finding Function Block with Open Connections</i> in 6-3-3 <i>Programming Using Function Blocks</i> and <i>Precautions Updating from Network Configurator Version 1.3□ to a Higher Version on page xxxi</i>.</p>

8-3 Errors When Resetting

8-3-1 Outline

When the NE1A-series Controller or a DST1-series or other Safety Device is reset, the device may return an error response. The cause of the error can be determined from the error information shown in the Network Configurator.

8-3-2 Error Messages and Countermeasures

Message displayed on the Network Configurator	Countermeasures
Object state conflict.	The specified reset cannot be executed in the current device status. Refer to 9-2-2 <i>Reset Type and NE1A-series Controller Status</i> in the <i>Safety Network Controller Operation Manual (Z906-E1-07 or higher)</i> and change the operating mode or configuration lock status of the NE1A-series Controller. Then execute the reset again.
Invalid TUNID of Device (%s). Device will be reset by Device's TUNID. OK?	The TUNID saved to the device and the TUNID specified by Network Configurator do not match. Check that the device node address matches and execute the reset if it is OK to use the device TUNID.
Privilege violation.	The password used does not provide authority to change configurations. Check that the correct password is being used.
Specified device can not be accessed, or wrong device type or password.	The device has just been reset or the power cycled and the device is not ready for communications (i.e., not online with the NS indicator flashing or lit green.) Check that the device is communications ready then reset.
	The device specified for reset may not support that service. Check that the device node address is correct.
	The configuration data is locked. (The LOCK indicator is lit.) Remove the lock then execute the specified reset.
	The device is performing safety I/O communications and cannot, therefore, execute the specified reset. Change the operating mode of the relevant Safety Master to IDLE mode. Then execute the specified reset.
Connection failed.	Tried to reset a device on the DeviceNet network via the NE1A-series Controller USB port, but connection failed. Check that power is turned ON to the device and reset again. If the above cause does not apply, noise or other factors may be making communications unstable. Check the following items. <ul style="list-style-type: none"> • Do all nodes have the same baud rate? • Is the cable length correct (trunk lines and branch lines)? • Is the cable disconnected or slack? • Is the terminating resistance only on both ends of the main line? • Is there a lot of noise?
The specified operation cannot be performed on this network. Use the DeviceNet network. (Only for Controllers that support EtherNet/IP.)	This will always be displayed when a Controller that supports EtherNet/IP is reset from the EtherNet/IP Network Window. If there is no problem with executing a reset using the device TUNID, execute the reset from the DeviceNet Network Window.

8-4 Errors When Changing Modes

8-4-1 Outline

When the operating mode of the NE1A-series Controller or DST1-series or other Safety Device is changed, the device may return an error response. The cause of the error can be determined from the error information shown in the Network Configurator.

8-4-2 Error Messages and Countermeasures

Message Displayed on the Network Configurator	Countermeasures
Object state conflict.	A fatal error (Abort) (MS indicator flashes red) has occurred. Set the switches correctly or execute reset (Out-of-Reset) to clear the configuration data.
Object state conflict.	<ol style="list-style-type: none"> The device has not been configured (Configuration Mode). Download the device parameters. A fatal error (Abort) has occurred. Set the switches correctly or execute reset (return to default settings and restart) to clear the configuration data. Once the configuration data is cleared, download the device parameters again.
Already set to the specified mode.	The device is already in the specified operating mode.
The TUNID is not matched.	The TUNID saved to the device and the TUNID specified by the Network Configurator do not match. Check that the device node address matches. If it does, it means that the device network number and the network number in the Network Configurator do not match. Select Network – Upload in the Network Configurator to match the network numbers.
Privilege violation.	The password used does not provide authority to change the operating mode. Check that the correct password is being used.
Specified device can not be accessed, or wrong device type or password.	The device has just been reset or the power cycled and the device is not ready for communications (i.e., not online with the NS indicator flashing or lit green.) Check that the device is communications ready then reset.
	The device for which the operating mode change request was made may not support that service. Check that the device node address is correct.
Connection failed.	<p>Tried to change the operating mode of a device on the DeviceNet network via the NE1A-series Controller USB port, but connection failed. Check that power is turned ON to the device and reset again.</p> <p>If the above cause does not apply, noise or other factors may be making communications unstable. Check the following items.</p> <ul style="list-style-type: none"> • Do all nodes have the same baud rate? • Is the cable length correct (trunk lines and branch lines)? • Is the cable disconnected or slack? • Is the terminating resistance only on both ends of the main line? • Is there a lot of noise?

8-5 Errors That Can Be Found Using the Connection Check Function

8-5-1 Outline

Communications errors that are likely to occur can be detected prior to downloading to the system the network configuration files created by the Network Configurator. The Connection Check function can be accessed by selecting **Network - Check Connection** from the Network Configurator.

8-5-2 Display Messages and Countermeasures

When the connection check function is activated and a communications error is likely to occur, the following dialog box will appear and the problem will be displayed.

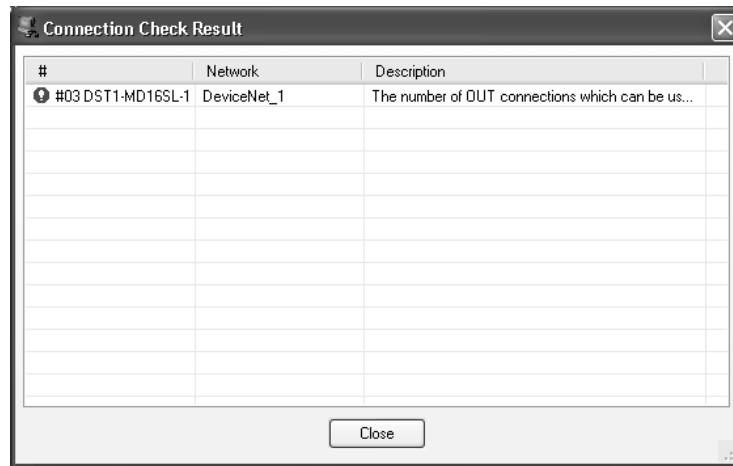

The messages that may be displayed and the countermeasures are given in the following table.

Message displayed on the Network Configurator	Countermeasure
The Safety Slave (node address) does not exist.	Check the Register Device List of the corresponding NE1A-series Controller, and remove the items listed as "Unknown Device".
The device type of the Safety Slave (node address) is incorrect.	Look at the Register Device List of the corresponding NE1A-series Controller, and check the device types of the registered node addresses and devices in the virtual network.
The Safety Slave (node address) TUNID is incorrect.	Go to Network - Property and make sure that the network numbers are unified.
The connection point of the Safety Slave (node address) for a connection (connection name) does not exist.	Look at the Register Device List of the corresponding NE1A-series Controller, and check the device types of the registered node addresses and devices in the virtual network.
The configuration data of a connection (connection name) and its corresponding Safety Slave (node address) do not match.	Check the Register Device List of the corresponding NE1A-series Controller, and click the OK Button.
The Safety Slave (node address and device name) does not exist, or the route bus is incorrect.	Check the Register Device List of the corresponding NE1A-series Controller, and remove the items listed as "Unknown Device."
The connection point of the Safety Slave (node address and device name) corresponding to a connection (connection name) does not exist.	Check the Register Device List of the corresponding NE1A-series Controller, and remove the items listed as "Unknown Device."
The configuration data of a connection (connection name) and the corresponding Safety Slave (node address) do not match.	Check the Register Device List of the corresponding NE1A-series Controller, and click the OK Button.

<p>Message displayed on the Network Configurator</p>	<p>Countermeasure</p>
<p>The EPI of the connection (node address: connection name) is outside the supported range.</p>	<p>Check the Register Device List of the corresponding NE1A-series Controller, and adjust the EPI of the connection to within supported range.</p>
<p>The EPI of the connection (node address: network name: connection name) is outside the supported range.</p>	<p>Check the Register Device List of the corresponding NE1A-series Controller, and adjust the EPI of the connection to within the supported range.</p>
<p>The number of OUT connections has exceeded the limit.</p>	<p>Check the number of Masters the corresponding device is registered to.</p>
<p>The connection (connection name) is registered as connections to multiple nodes.</p>	<p>Check the Register Device List of the corresponding NE1A-series Controller, and check its connections.</p>
<p>The number of IN connections has exceeded the limit.</p>	<p>Check the Register Device List of the corresponding NE1A-series Controller.</p>
<p>The number of connections has exceeded the limit.</p>	<p>Check the Register Device List of the corresponding NE1A-series Controller.</p>
<p>There is no usable connection ID resource.</p>	<p>Set the Expansion Connection Setting to Check Produced IDs in the Safety Slave in the Connection Settings Window.</p>
<p>There is no usable target connection ID resource. Change the Safety Master ID allocation setting.</p>	<p>Set the Expansion Connection Setting to Check Produced IDs in the Safety Slave in the Connection Settings Window.</p>

SECTION 9

Maintenance Tool

The section provides an overview of the Maintenance Tool, describes its parts and functions, describes basic operating procedures, and provides hardware handling procedures. Read this section before you attempt to use the Maintenance Tool.

9-1	Overview of Maintenance Tool	250
9-1-1	Maintenance Tool	250
9-1-2	Differences with Network Configurator Functions	252
9-2	Starting and Exiting the Maintenance Tool and Version Information	253
9-2-1	Starting and Exiting the Maintenance Tool	253
9-2-2	Displaying the Version Information	254
9-3	Screen Names and Functions	255
9-3-1	Main Window	255
9-3-2	Function Icons	256
9-4	Setting the Monitor Refresh Time	257
9-5	Basic Online Operations	258
9-5-1	Connecting the Maintenance Tool	258
9-5-2	Specifying the Network Number	259
9-5-3	Changing the Connected Device	261
9-6	Reading Device Information	263
9-6-1	Overview	263
9-6-2	Monitoring I/O Terminals	263
9-6-3	Reading Device Status, Alarms, and Warning Information	265
9-6-4	Reading the Error History	267
9-7	Replacing a Device	270
9-8	Uploading to Individual Devices	274
9-9	Downloading for Individual Devices	276
9-9-1	Creating Device Parameter Files	276
9-9-2	Downloading or Restoring Parameters	276
9-10	Uploading (Network)	280
9-11	Downloading (Network)	282
9-12	Resetting a Device	285
9-12-1	Reset Types	285
9-12-2	Resetting a Device	286
9-13	Changing the Mode	288
9-14	Locking/Unlocking Devices	290
9-15	Change Passwords	292

9-1 Overview of Maintenance Tool

This section gives an overview of the Maintenance Tool.

9-1-1 Maintenance Tool

The Maintenance Tool is a special software application used to perform maintenance for DeviceNet Safety Networks.

The Maintenance Tool can be connected to Safety Devices on the DeviceNet Safety Network using a USB cable to monitor individual devices. It also enables replacing devices or backing up and downloading parameters for an entire network at the same time.

Application Range of Maintenance Tool on the DeviceNet Safety Network

Application Range of Maintenance Tool

Devices in the following range can be maintained with the Maintenance Tool when it is connected to a Safety Network Controller.

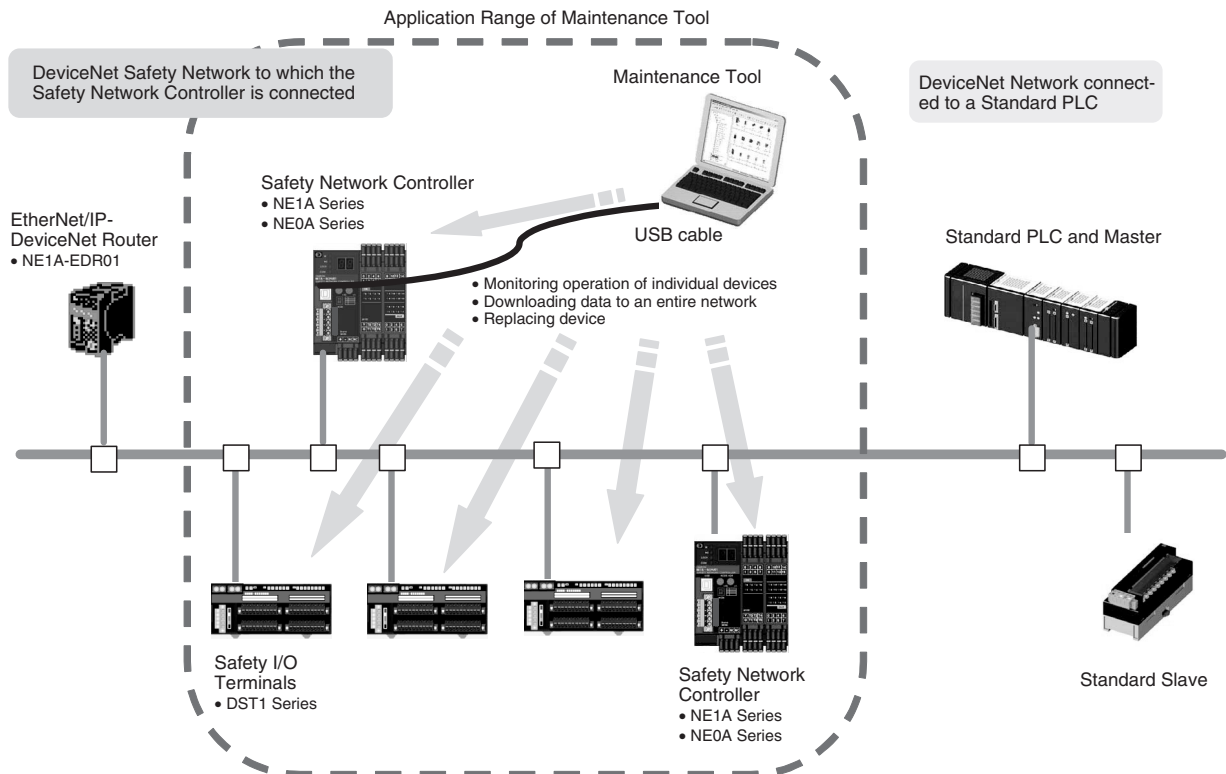

Connectable DeviceNet Safety Devices

The following devices can be maintained by using the Maintenance Tool.

Series	Model
NE1A Series	NE1A-SCPU01
	NE1A-SCPU01-V1 (unit version 1.0 or 2.0)
	NE1A-SCPU02 (unit version 1.0 or 2.0)
	NE1A-SCPU01-EIP (unit version 1.0 or 1.1)
	NE1A-SCPU02-EIP (unit version 1.0 or 1.1)
NE0A Series	NE0A-SCPU01
DST1 Series	DST1-ID12SL-1
	DST1-MD16SL-1
	DST1-MRD08SL-1
	DST1-XD0808SL-1

Features of the Maintenance Tool

Compatible with DeviceNet Safety Devices

The Maintenance Tool is compatible with NE0A/NE1A Safety Network Controllers as well as DST1-series Safety I/O Terminals.

Affinity with the Network Configurator

Network configuration files (*.ncf) and device parameter files (*.dvf) are created with the Network Configurator and used with the Maintenance Tool.

Display of Errors and Countermeasures

The status of and countermeasures for errors are displayed in a dialog box.

9-1-2 Differences with Network Configurator Functions

The differences between the Maintenance Tool and Network Configurator functions are outlined in the following table.

OK: Possible, ---: Not possible

Item		Maintenance Tool	Network Configurator
Controllable DeviceNet Safety Devices		<ul style="list-style-type: none"> • NE1A Series • NE0A Series • DST1 Series 	<ul style="list-style-type: none"> • NE1A Series • NE0A Series • DST1 Series
Parameters	Upload	OK	OK
	Download	OK Verification executed at the same time.	OK
	Compare	---	OK
	Lock, Unlock	OK Verification executed at the same time.	OK
	Edit	---	OK
	Read	OK	OK
	Save	OK	OK
Creating and editing programs		---	OK
Monitoring (Monitor, Device Status, Device Property)		OK	OK
Device replacement (Automatic upload/download function)		OK	---
Resetting		OK	OK
Changing the mode		OK	OK
Changing passwords		OK	OK
Displaying countermeasures for errors		OK	OK

9-2 Starting and Exiting the Maintenance Tool and Version Information

This section describes how to start and exit the Maintenance Tool and how to check the version.

9-2-1 Starting and Exiting the Maintenance Tool

Start Procedure

- 1,2,3... 1. Select **Programs – OMRON Network Configurator for DeviceNet Safety - Maintenance Tool** from the Windows Start Menu.
- The Maintenance Tool will start, and the following Main Window will be displayed.

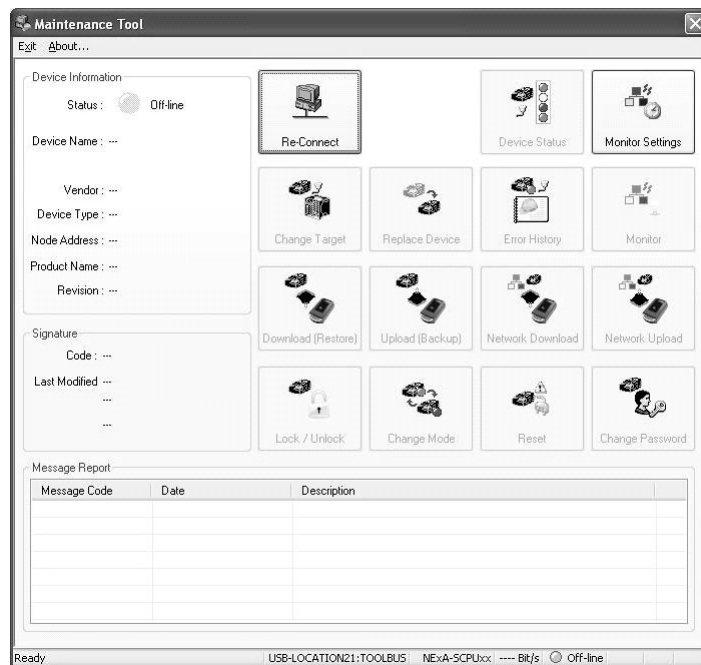

Closing Procedure

- 1,2,3... 1. Select **Exit** in the Main Window.
- The Maintenance Tool will close.

9-2-2 Displaying the Version Information

Version information for the Maintenance Tool can be displayed.

1,2,3...

1. Select **About** from the menu bar.

The version information of the Maintenance Tool will be displayed.

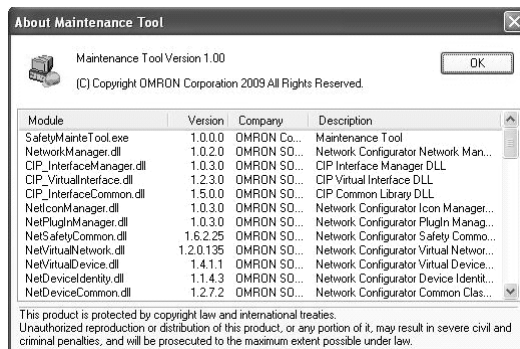

2. Click the **OK** Button.

The display will return to the Main Window.

9-3 Screen Names and Functions

9-3-1 Main Window

When the Maintenance Tool power supply is turned ON, the Main Window will be displayed on the screen. Icons for functions supported by the Maintenance Tool and information about connected DeviceNet Safety Devices will be displayed.

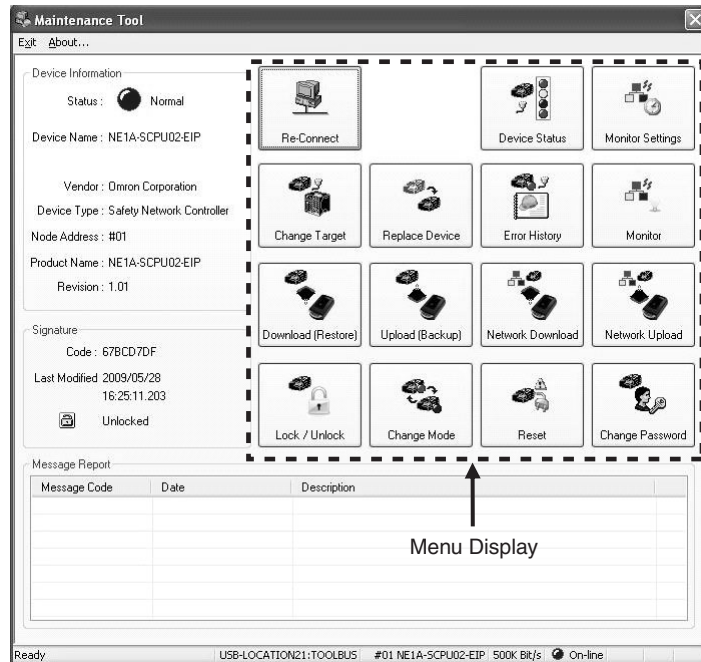

Function Menu Display

Click the function icon to execute a function. The icons of the functions that cannot be used offline will be displayed in gray and cannot be selected.

Device Information

Status

The status of the connected device is displayed. The status is automatically updated.

The device status is indicated by the following colors.

Color	Status
Blue	RUN
Green	IDLE
Yellow	Warning
Red	Alarm
Gray with white outline	Disconnected
Gray with green outline	Default status (not configured)

Other Information

The node address, vendor ID, model number, product name, and revision of the connected DeviceNet Safety Device are displayed.















Safety Signature

The safety signature and lock status of the connected DeviceNet Safety Device are displayed.

Message Report Pane

Information on errors that occur during communications (e.g., downloading or uploading) with devices is displayed.

9-3-2 Function Icons

Function name	Icon	Description	Reference
Reconnect		Connects a device online when the Maintenance Tool and a device are not connected.	9-5-1
Device Status		Displays the device status as well as details of alarms and warnings. Maintenance information for the connected device will be displayed on the Maintenance Tab Page.	9-6-3
Monitor Refresh Timer Settings		Sets the interval for refreshing the timing of data obtained with the monitor function.	9-4
Change Target		This function is used to change the connected device.	9-5-3
Replace Device		Device parameters uploaded from the connected device are downloaded after replacing the device.	9-7
Error History		Displays the error history of the connected device. Maintenance information for the connected device will be displayed on the Maintenance Tab Page.	9-6-4
Monitor		Displays the connected device's I/O terminal status. Maintenance information for the connected device will be displayed on the Maintenance Tab Page.	9-6-2
Download (Restore)		Downloads the specified *.dvf file (i.e., device parameter file) to the connected device.	9-9
Upload (Backup)		Uploads the device parameters of the connected device and saves them on the computer as a *.dvf file (i.e., device parameter file).	9-8
Download Network		The specified network configuration files (*.ncf) will be downloaded to the safety devices connected to the network to which the connected device belongs.	9-11
Upload Network		The network configurations will be uploaded as network configuration files (*.ncf) from the safety devices connected to the network to which the connected device belongs. The files will be saved on the computer.	9-10
Lock Unlock		Locks or unlocks the configuration of the connected devices.	9-14
Change Mode		Changes the operating mode of the connected device.	9-13
Reset		Resets the connected device.	9-12
Change Password		Changes a device password.	9-15

9-4 Setting the Monitor Refresh Time

Set the monitor refresh timer value for the data acquired by the monitor function.

- 1,2,3... 1. Click the **Monitor Settings** Icon in the Main Window.

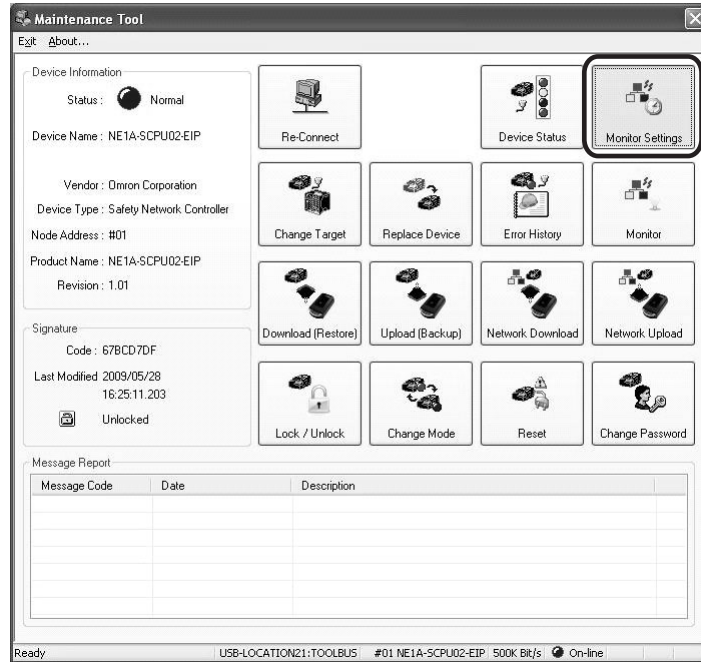

The following dialog box will be displayed.

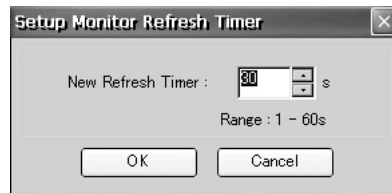

2. Set the new refresh timer value and click the **OK** Button.
The new setting will be applied and the display will return to the Main Window.

9-5 Basic Online Operations

This section describes the procedure for online operations. Make sure that you read through the material before performing online operations.

9-5-1 Connecting the Maintenance Tool

The Maintenance Tool can be used by connecting it to the USB port on an NE0A/NE1A-series Controller.

When the Maintenance Tool is connected to the USB port of an NE0A/NE1A-series Controller, the following Main Window will be displayed. The device status will be displayed in the Main Window.

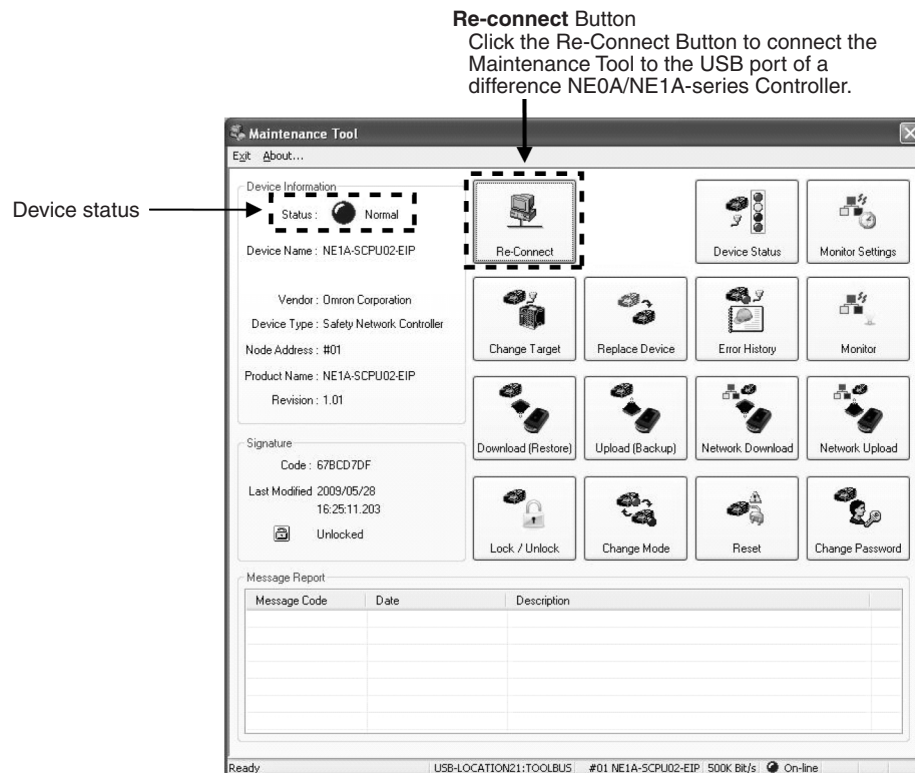

Note Click the **Re-Connect** Button if the USB cable is disconnected and connected to the USB port of another NE0A/NE1A-series Controller after the Maintenance Tool has been connected online.

Device Status

The device status is indicated by the following colors.

Color	Status
Blue	RUN
Green	IDLE
Yellow	Warning
Red	Alarm
Gray with white outline	Disconnected
Gray with green outline	Default status (not configured)

9-5-2 Specifying the Network Number

DeviceNet Safety enables building systems using multiple networks, and so it is necessary to specify the network number even if the user system has only one network.

Specify the network number with the Maintenance Tool in the following cases.

- Connecting to a device in its default status, such as for device replacement
- Resetting devices using the Maintenance Tool (returning to default settings and selecting restart)

Use the following procedure to specify the network number when connecting to a device in its default status.

- 1,2,3... 1. Connect to the device in its default status and click the **Re-connect** Button.

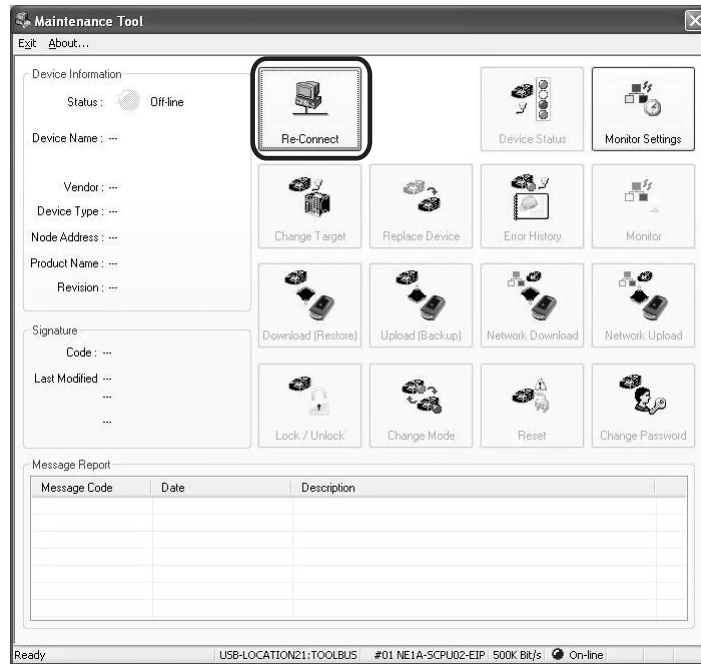

The following dialog box will be displayed.



2. Click the **OK** Button. The following dialog box will be displayed.

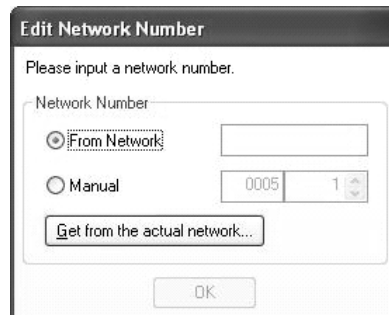

- Click the **Get from the actual network** Button.

The network number will be displayed as shown in the following figure when it is successfully obtained.

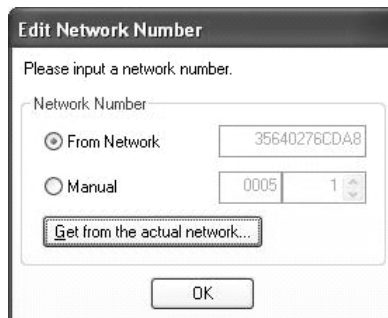

- Click the **OK** Button.

After the network number has been specified, the Main Window will be displayed.

Note To obtain the network number from the network, turn ON the DeviceNet network power supply. If there is more than one network number on the same network, be sure to select the correct network number.

IMPORTANT If the network number is specified manually, it will be displayed with zeros inserted between the fifth to eighth digits from the right when the network number is obtained from a network. (Example: 000500000001)

IMPORTANT If you know that the network number has been specified manually, you select the *Manual* Option to specify it manually rather than obtaining it from the network.

Checking the Network Number with the Network Configurator

You can use the following procedure to check the network number that is set for the user system.

- 1,2,3...** 1. Open the network configuration file that was downloaded to the system from the Network Configurator.
2. Select **Network - Property** from the menu bar.

The following dialog box will be displayed.

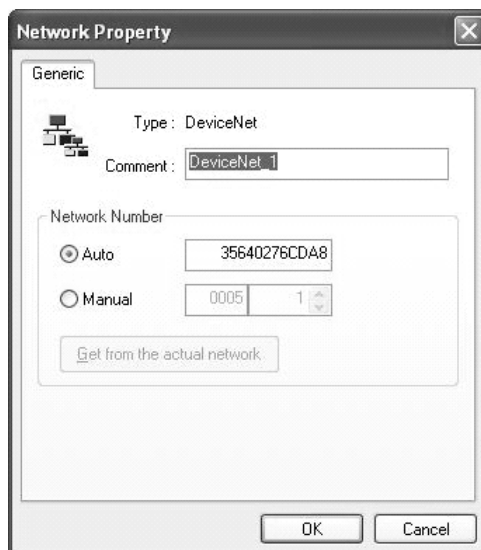

3. Check the displayed network number.

9-5-3 Changing the Connected Device

This section describes how to change the connected device. The Maintenance Tool can be connected to devices that are on the same DeviceNet network as the NE0A/NE1A-series Controller connected with the USB cable.

- 1,2,3... 1. Click the **Change Target** Icon in the Main Window.

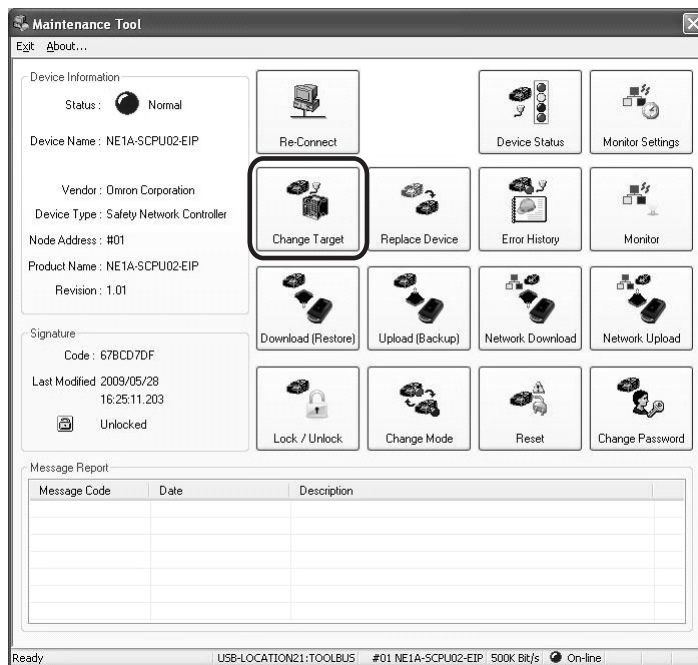

The following dialog box will be displayed.

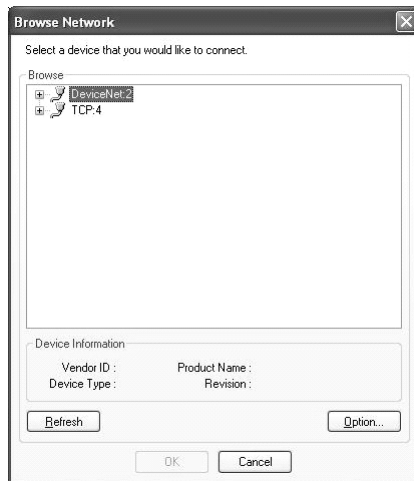

When you click the plus sign or **Refresh** Button, the network will be scanned and the devices that are on the same DeviceNet network as the NE0A/NE1A-series Controller that is connected with a USB cable will be displayed.

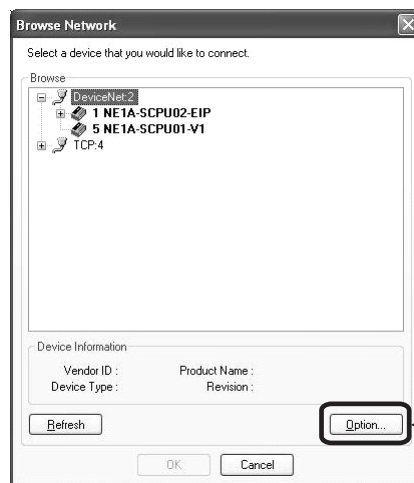

For information on the Option Button refer to *Option Dialog Box* in the following section.

2. Select the connected device and click the **OK** Button.

The connected device will be updated, and the system will return to the Main Window.

Option Settings Browse Network Dialog Box

Click the **Option** Button in the Browse Network Dialog Box. The following dialog box will be displayed.

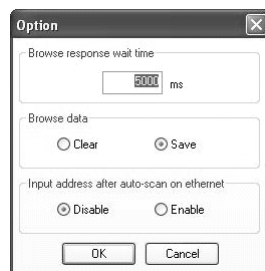

Browse Response Monitor Timer

The browse response monitor timer specifies the communications timeout value when the device information is updated in the Browse Network Dialog Box. The default is 5,000 ms.

Browse Status

You can specify whether to save the status of updated devices in the Browse Network Dialog Box. If the browse status is set to Save, the status of updated devices will be held even if the Browse Network Dialog Box is opened again. The default setting is to not save the status.



Inputting User Address after Automatic Ethernet Scan

You can specify whether to manually input missing IP addresses after the Ethernet/IP network has been scanned. By default, this option is not selected. (The Maintenance Tool does not support Ethernet/IP networks, and so this function cannot be used.)

9-6 Reading Device Information

9-6-1 Overview

The following three types of device information can be read with the Maintenance Tool.

Icon	Function name	Description
	Monitor	Displays the connected device's I/O terminal status. Errors occurring at the connected device will be displayed on the Maintenance Tab Page. (See note 1.)
	Device Status	Displays the device status as well as information on alarms and warnings. Errors occurring at the connected device will be displayed on the Maintenance Tab Page. (See note 1.)
	Error History	Displays the error history of the connected device. Errors occurring at the connected device will be displayed on the Maintenance Tab Page. (See note 1.)

- Note**
- (1) The contents of the **Maintenance** Tab for the Monitor, Device Status, and Error History functions are the same. The items displayed will depend on the connected device.
 - (2) The device status will be displayed as an icon in the Main Window when a device is online. (Refer to 9-5-1 *Connecting the Maintenance Tool*.)

Procedure

- 1,2,3...**
1. Connect the Maintenance Tool to the USB port of the NE0A/NE1A-series Controller.
 2. Click the **Change Target** Icon and specify the device to be monitored.
 3. Click the **Monitor, Device Status, or Error History** Icon to read the device information.

- Note** The device information (parameters and errors) depends on the device that is connected. Refer to the device manual for details on parameters and errors.

9-6-2 Monitoring I/O Terminals

The status of the I/O terminals on an NE0A/NE1A-series or DST1-series Controller can be monitored. Monitoring the status can help in troubleshooting errors occurring at the I/O terminals. The displayed parameters will depend on the device that is connected. Refer to the device manual for details on parameters.

- 1,2,3...**
1. Click the **Monitor** Icon in the Main Window.

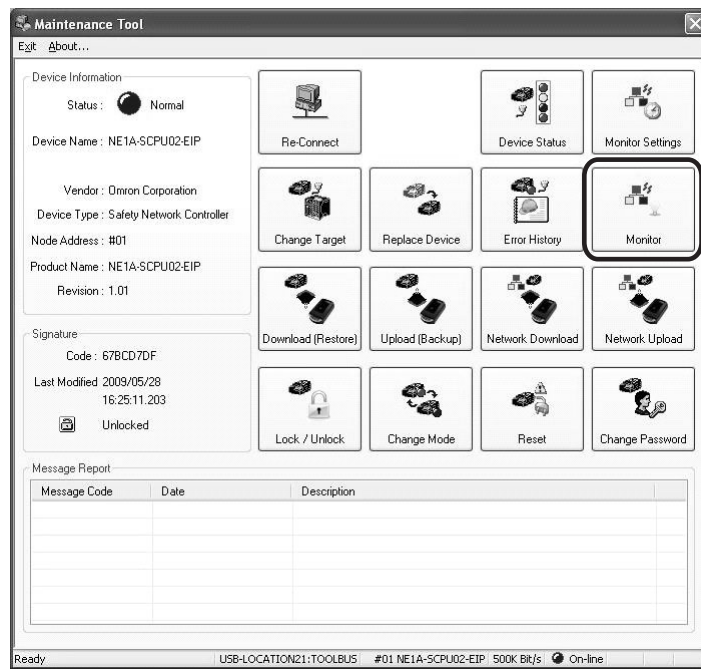

The current status of the I/O terminals will be displayed on the Parameters Tab Page.

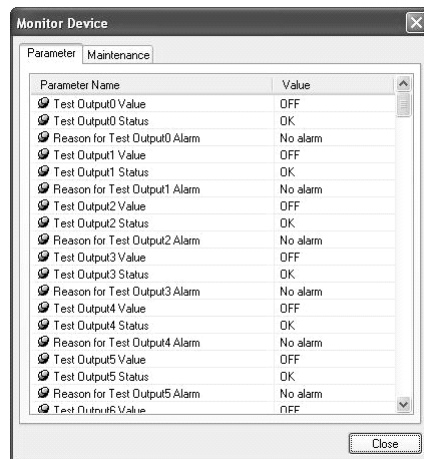

2. Click the **Maintenance** Tab.

If an error exists in the connected device, the following will be displayed.

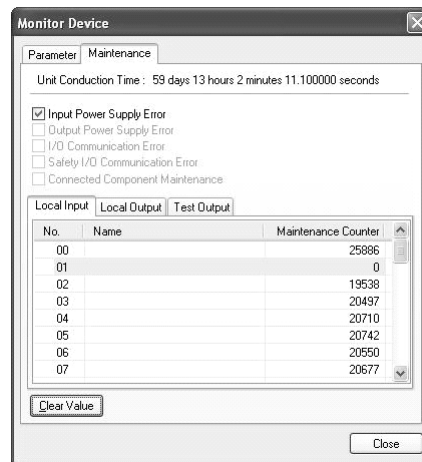

- Click the **Clear Value** Button to reset the terminal maintenance counters to 0.

9-6-3 Reading Device Status, Alarms, and Warning Information

The status of the connected device as well as information on alarms and warnings can be displayed. The displayed parameters depend on the device that is connected.

- 1,2,3... 1. Click the **Device Status** Icon in the Main Window.

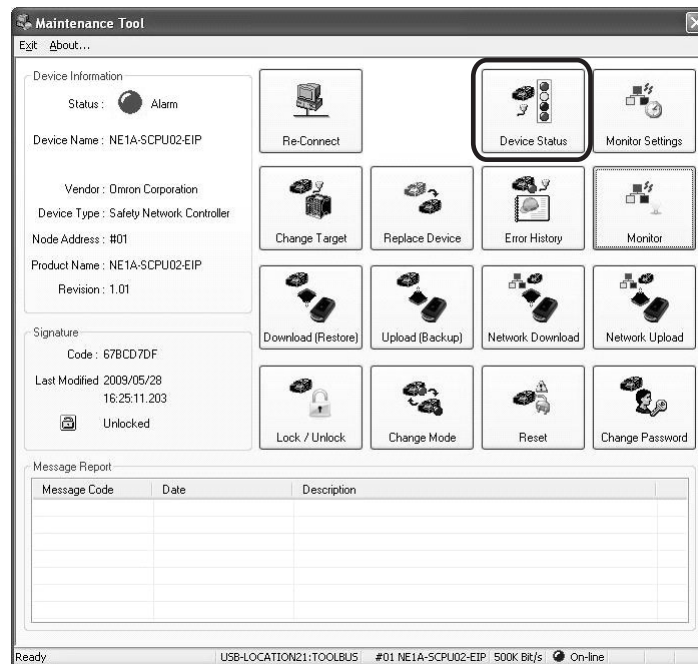

The device status, as well as current alarms and warnings, will be displayed.

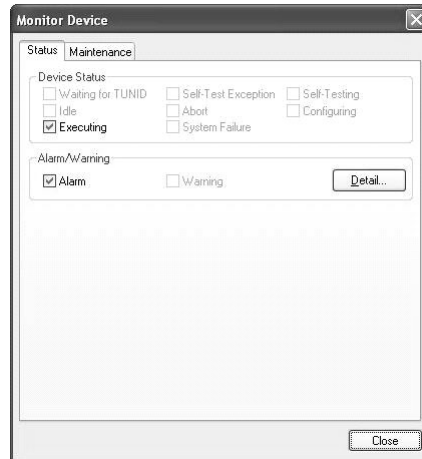

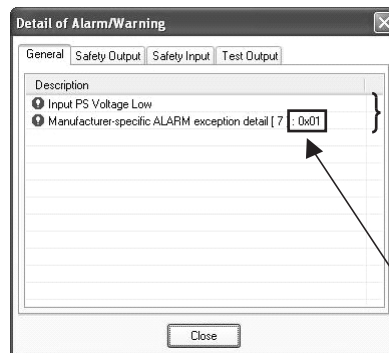

- Click the **Detail** Button to display details on current alarms and warnings as shown below.



Error information will be displayed in pairs.

Address of node with error or error response value.

- The  icon will be displayed for alarms and the  icon for warnings.
- The Detail of Alarm/Warning Dialog Box has the following tab pages: General, Safety Output, Safety Input, and Test Output. The General Tab Page displays the current errors. The other tab pages display errors occurring at the output terminals, the input terminals, and the test output terminals.

2. Click the **Maintenance** Tab.

Current errors in the device will be displayed as shown below.

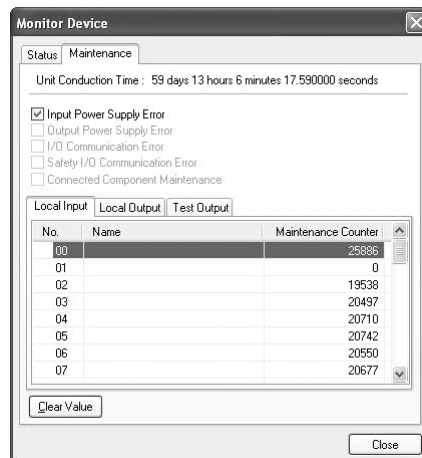

- Refer to 9-6-2 *Monitoring I/O Terminals* for details on the Maintenance Tab Page.

9-6-4 Reading the Error History

The error history of the NE0A/NE1A-series or DST1-series Controller can be displayed. The number of records that can be saved depends on the device. Some errors are not deleted even if power supply is interrupted because they are saved in nonvolatile memory. Other errors are deleted when the power supply is interrupted because they are saved in the RAM. Refer to the device manual for details.

- 1,2,3... 1. Click the **Error History** Icon in the Main Window.

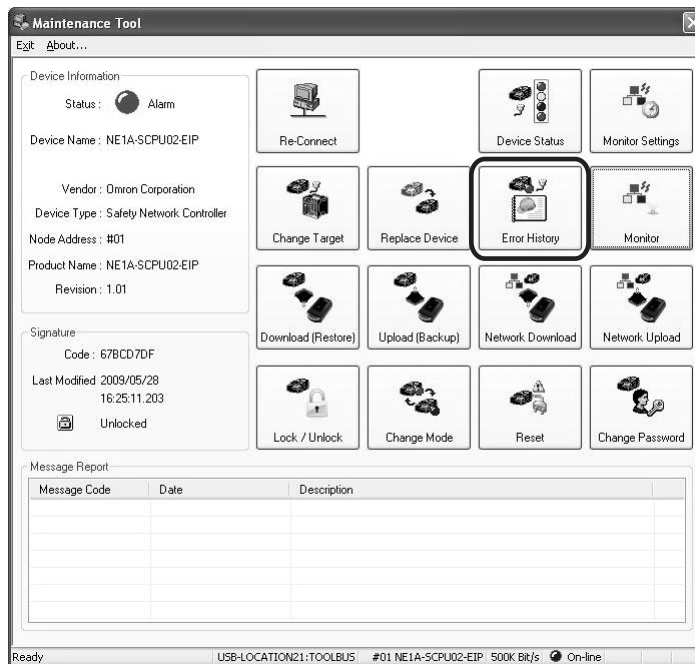

The following dialog box with the device error history will be displayed.

The EtherNet/IP Error History Tab is displayed only if the NE1A-SCPU01-EIP or NE1A-SCPU02-EIP Controller is connected online.

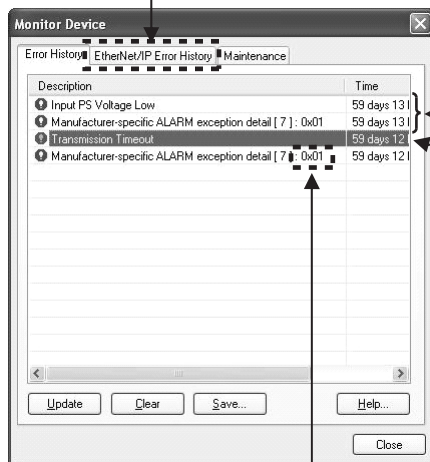

Error information is displayed in pairs.

The following dialog box for countermeasures will be displayed when you double-click the error history item or select the error history item and then click the Help Button.

Node address of error occurrence or error response value

Click the **EtherNet/IP Error History** Tab.

(This function is supported only for NE1A-SCPU01-EIP or NE1A-SCPU02-EIP.)

The following dialog box will be displayed.

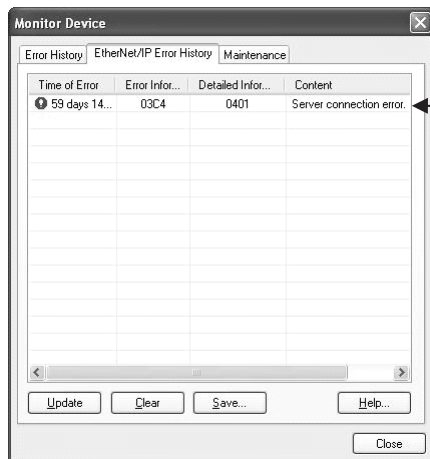

The following dialog box for countermeasures will be displayed when you double-click the error history item or select the error history item and then click the Help Button.

Example of Countermeasures:

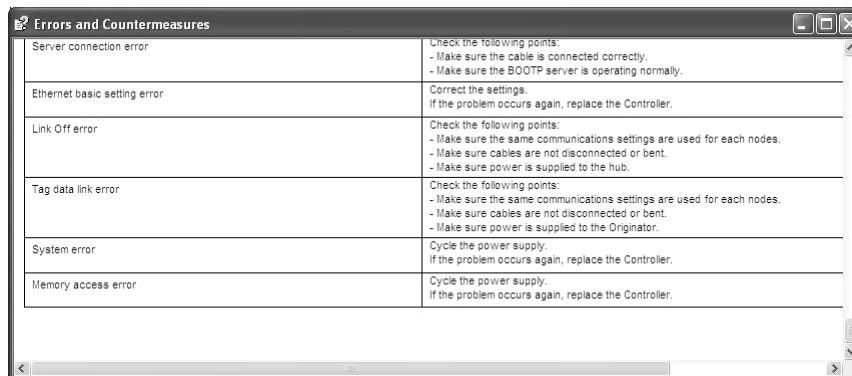

Item or Button	Description
Description Content	Gives the error.
Time of Error	Displays the total ON time of the device when the error occurred. The display will always be 0 for a DST1-series Controller.
Error Information	Code number for error that occurred. For details, refer to the manual for the device.
Detailed Information	Detailed code number for error that occurred. For details, refer to the manual for the device.
Update Button	Updates the error history.
Clear Button	Deletes the error history saved in the device.
Save Button	Saves the error history information in CSV format.
Help Button	Select an error and click the Help Button to display the countermeasures.

2. Click the **Maintenance** Tab.

Current errors in the connected device will be displayed as shown below.

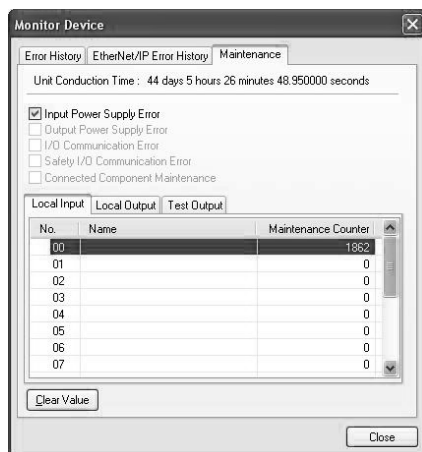

- Refer to 9-6-2 Monitoring I/O Terminals for details on the Maintenance Tab Page.

9-7 Replacing a Device

Devices can be easily replaced using the Replace Device function.

- Note**
- (1) Use the Replace Device function with safety devices in the user system with the configuration verified or locked. If the Device Replacement function is used for a device that does not have its configuration verified or locked, the system may not operate correctly after replacement. For information on verifying and locking configurations, referred to *9-9-1 Creating Device Parameter Files*.
 - (2) If a system error occurs because of a fatal hardware error in the device to be replaced, it will not be possible to use the Device Replacement function (on an NE1A-series Controller, the left side of the seven-segment display will show “H”, and on an NE0A-SCPU01 or DST1-series Controllers, the MS indicator will light red.) In these cases, use the download function to download the device parameters to the new device. For information on downloading device parameters, refer to *9-9 Downloading for Individual Devices*.

- 1,2,3...**
1. Connect the computer running the Maintenance Tool online to the device to be replaced.
 2. Click the **Replace Device** Icon in the Main Window.

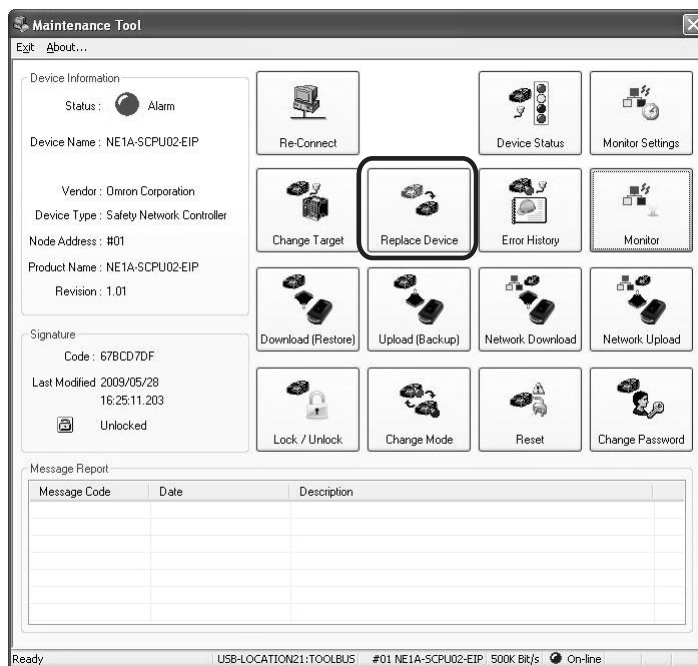

The following dialog box will be displayed.

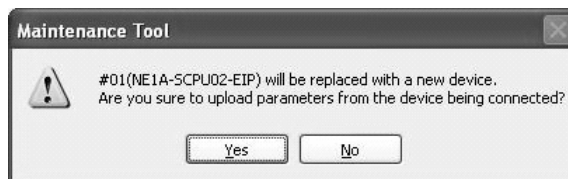

3. Click the **Yes** Button.
Parameters will be uploaded from the connected device.
 - If the **No** Button is clicked, the operation will be stopped and the display will return to the Main Window.

The following message will be displayed when upload has been completed.



4. Click the OK Button.



Note When replacing a device with a new device, the new device must be in default status. If a device is replaced with a configured device, the correct network number may not be set, which would prevent establishing connections for Safety I/O. Refer to 9-5-2 *Specifying the Network Number* for information on network numbers.

5. After replacing the device, click the **Yes** Button.

- If the Maintenance Tool is connected directly to a device via a USB cable, remove the USB cable and replace the device. Connect the USB cable to the new device and click the **Yes** Button.

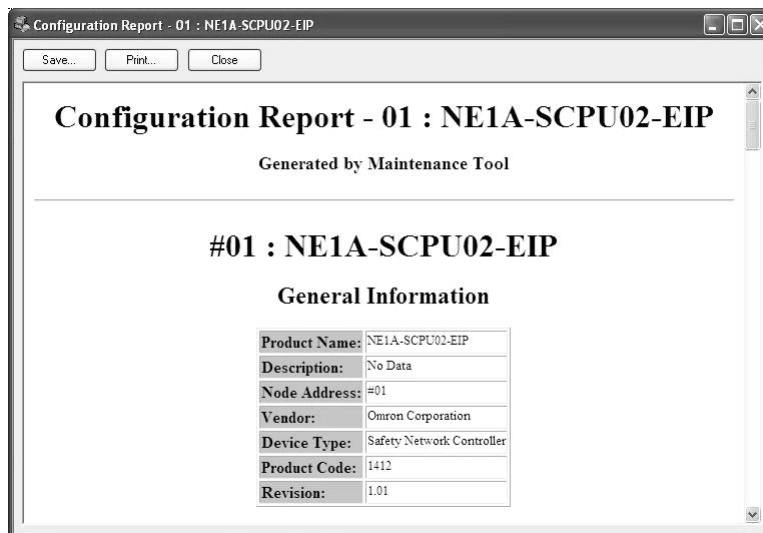

6. Confirm the device parameters to be downloaded, and then click the **Close** Button.



7. Click the **Yes** Button.

- The following dialog box will be displayed if the configuration is locked.

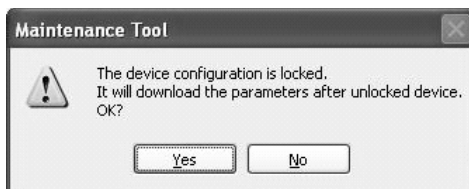

8. Click the **Yes** Button.
The password input dialog box will be displayed.



9. Enter the device password of the device connected online and then click the **OK** Button to start downloading. The following dialog box will be displayed after downloading has been completed.

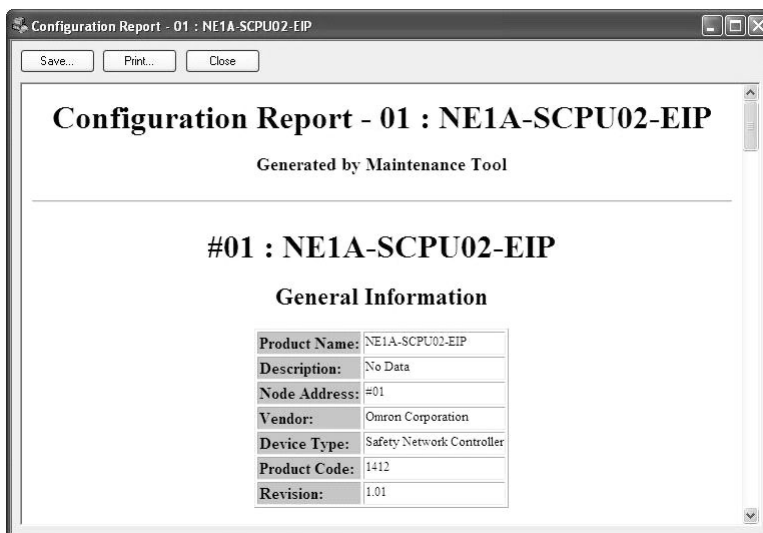

10. Confirm the report information, and then click the **Close** Button.
A dialog box asking whether to lock the device configuration will be displayed.



11. To lock the configuration, click the **OK** Button.
The following dialog box will be the displayed if the device before replacement was in RUN mode.



12. Click the **Yes** Button or the **No** Button.

- Click the **Yes** Button will set the device to RUN mode.
- Click the **No** Button will keep the device in IDLE mode.



13. Click the **OK** Button.



This completes replacing the device.

14. Click the **OK** Button.

The display will return to the Main Window.

Note The Maintenance Tool cannot be used to set the node address or IP address of a device. Set the node address and IP address of the replacement device in advance.

IMPORTANT Devices can also be replaced by using the following procedure: Upload the parameters and save them to a file, replace the device, download the parameters, and then lock/unlock the configuration.

WARNING	
Serious personal injury may possibly occur due to loss of safety functions. Observe the following precautions. After replacing a device, check to make sure that the replacement device is in the appropriate configuration and is operating correctly	

9-8 Uploading to Individual Devices

It is possible to obtain and save parameters of the device that is connected online.

- 1,2,3... 1. Click the **Upload (Backup)** Icon in the Main Window.

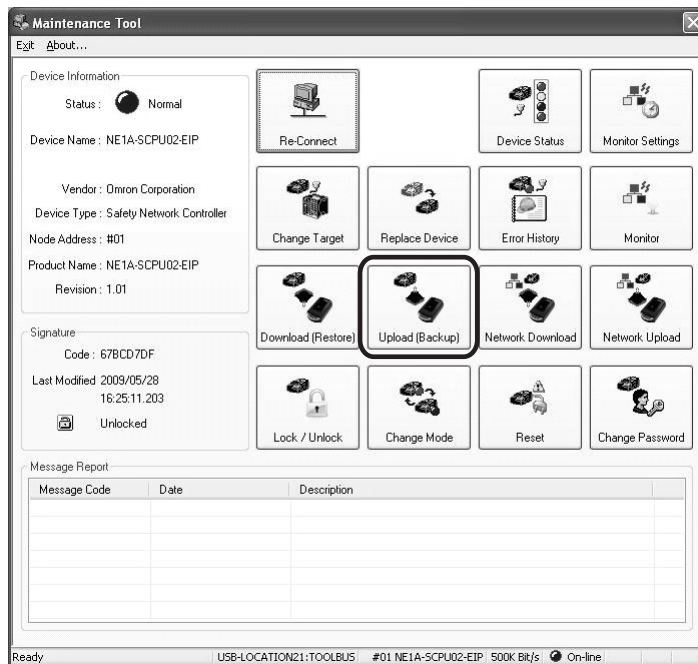

The following dialog box will be displayed.



2. Click the **Yes** Button.
- Click the **No** Button will cancel uploading.

The following dialog box will be displayed after uploading the device parameters has been completed.

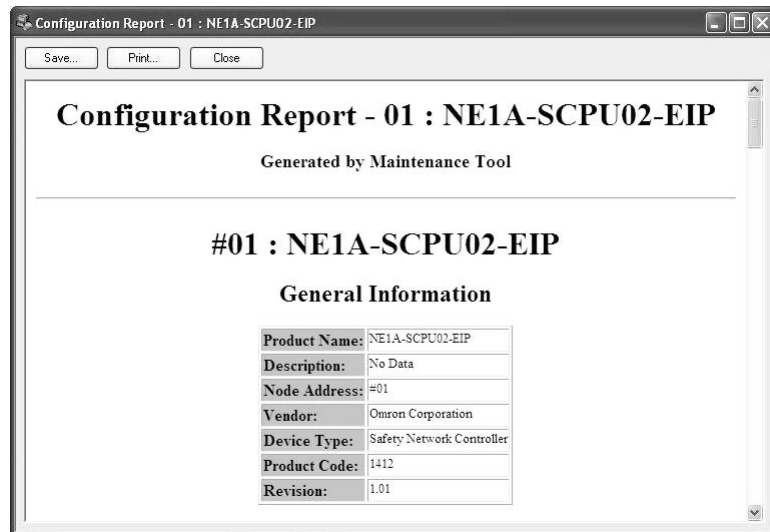

3. Confirm the report information, and then click the **Close** Button. The Save device parameters Dialog Box will be displayed. The file name will be automatically entered as shown in the following figure.

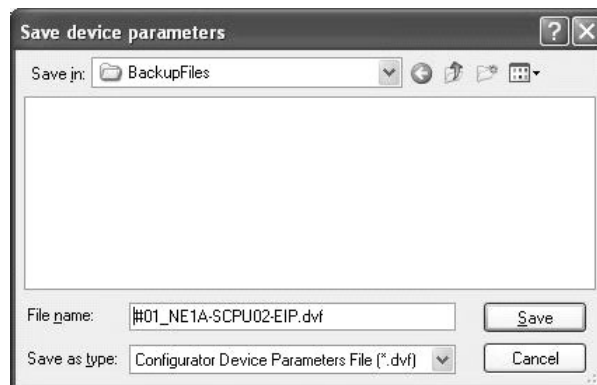

4. Confirm the file save location and file name, and then click the **Save** Button.



This completes the uploading procedure.

5. Click the **OK** Button. The display will return to the Main Window.

9-9 Downloading for Individual Devices

You can download parameter information to the device that is connected online.

9-9-1 Creating Device Parameter Files

Use the Network Configurator to create a device parameter file (*.dvf) to download or restore the parameters from the Maintenance Tool to the device.

- 1,2,3...
1. Start the Network Configurator and open the network configuration file (*.ncf).
 2. Confirm that the configuration of the device has been verified (as shown in the following figure with a green S mark) or locked (with a padlock mark).

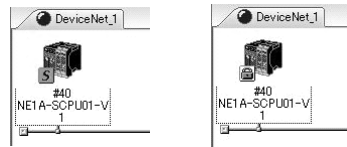

Note Create the device parameter file to be used for downloading or restoring parameters from the Maintenance Tool from a network configuration file (*.ncf) for which the configuration data has been verified or locked. The system may not operate correctly the file that is used has not been verified or locked.

3. Select the device, and then select **Device - Parameter - Save As** from the menu bar.

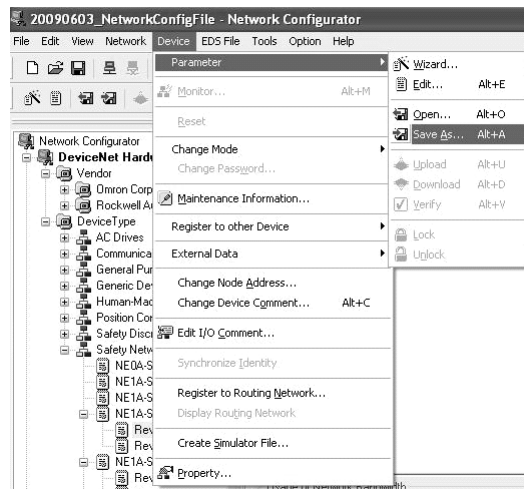

4. A device parameter file (*.dvf) will be created at the save location.

9-9-2 Downloading or Restoring Parameters

Download the created device parameter file (*.dvf) from the Maintenance Tool to the device.

- 1,2,3...
1. Click the **Download (Restore)** Icon in the Main Window.

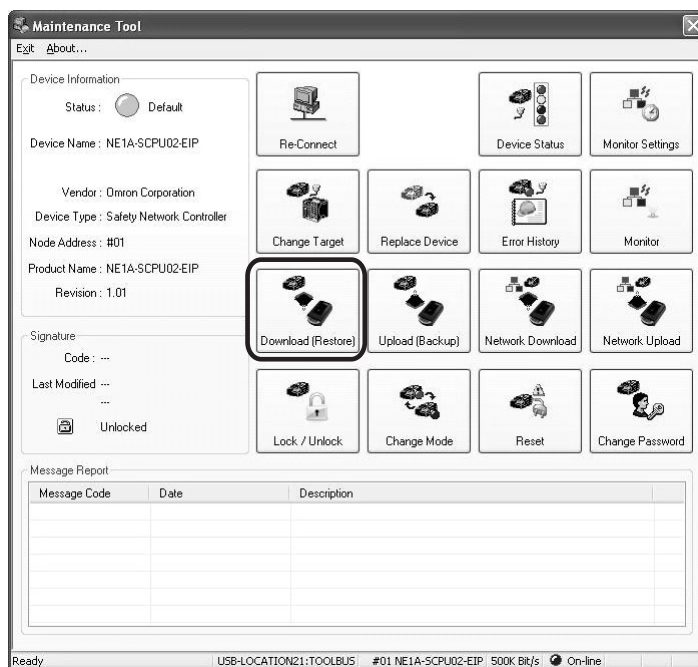

The Open device parameters Dialog Box will be displayed.

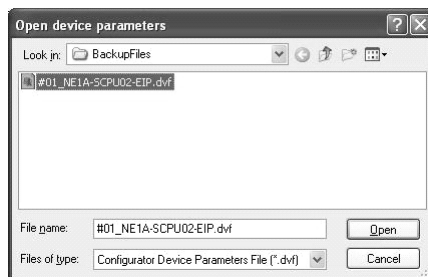

2. Confirm the file save location and file name, and then click the **Open** Button.

The following dialog box will be displayed.

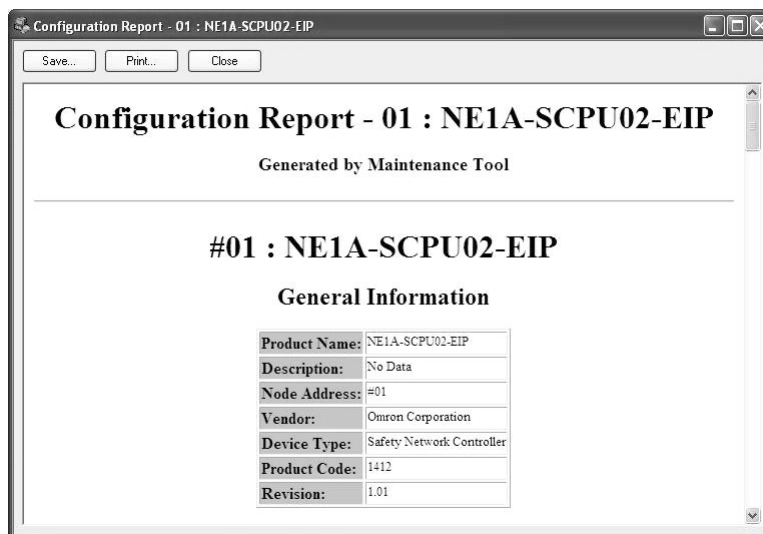

3. Confirm the report information, and then click the **Close** Button.

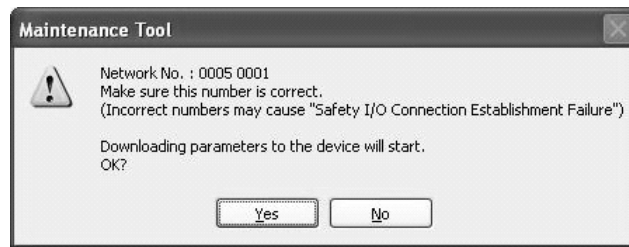

Note Be sure to confirm that the network number is correct. Safety I/O connections may not be established if the device is configured with the wrong network number. Refer to 9-5-2 *Specifying the Network Number* for information on network numbers.

4. Confirm the network number, and then click the **Yes** Button.

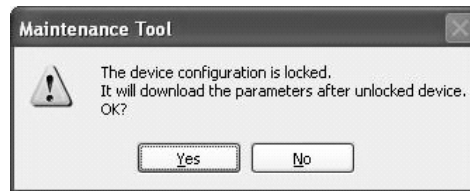

5. Click the **Yes** Button.

A dialog box for entering the password will be displayed.

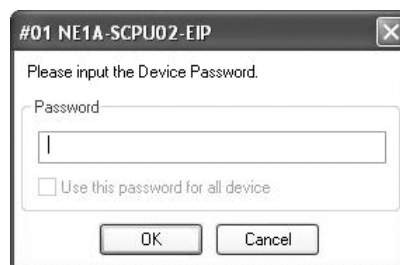

6. Enter the device password of the device connected online and then click the OK Button to start downloading. The following dialog box will be displayed after downloading has been completed.

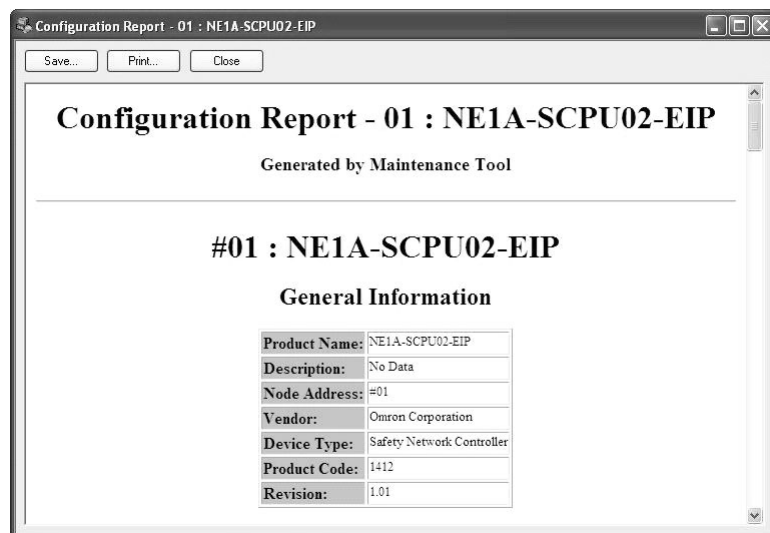

7. Confirm the report information, and then click the **Close** Button.

A dialog box will be displayed to confirm whether the device configuration is locked.



8. To lock the configuration, click the **Yes** Button.

The following dialog box will be displayed if the device before replacement was in RUN mode.

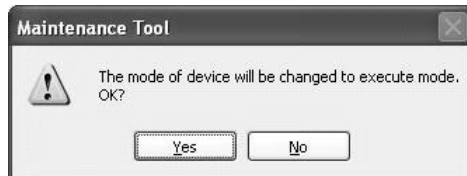

9. Click the **Yes** Button or **No** Button.
 - If you click the **Yes** Button, the device will enter RUN mode.
 - If you click the **No** Button, the device will enter IDLE mode.



This completes the downloading procedure.

10. Click the **OK** Button.

The display will return to the Main Window.

WARNING	
<p>Serious personal injury may possibly occur due to loss of safety functions. Observe the following precautions.</p> <p>Perform a user test before operating the system, and check to make sure that all the device configuration data and operations are correct.</p> <p>After replacing a device, check to make sure that the replacement device is in the appropriate configuration and is operating correctly</p>	

9-10 Uploading (Network)

It is possible to obtain and save parameters of devices that are connected online for an entire network.

- 1,2,3... 1. Click **Network Upload** Icon in the Main Window.

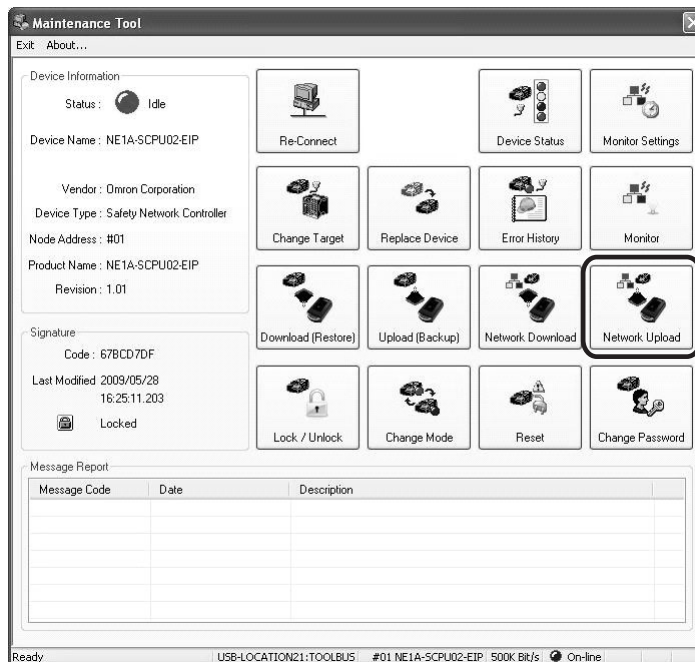

The following dialog box will be displayed.

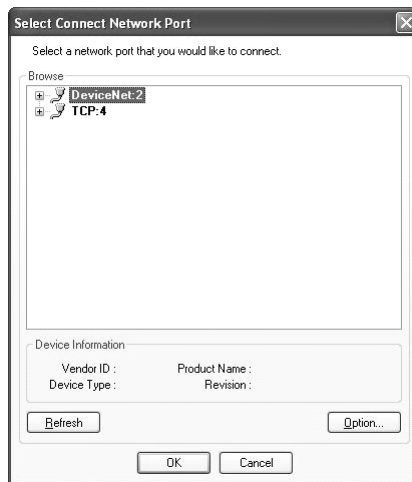

2. Specify the network to connect online and click the **OK** Button.

IMPORTANT To obtain the network number from the network, turn ON the DeviceNet network power supply. (EtherNet/IP networks are not supported.)



3. Click the **Yes** Button.
 - If you click the **No** Button, uploading will be canceled.

The Save Network Configuration Dialog Box will be displayed after uploading has been completed.

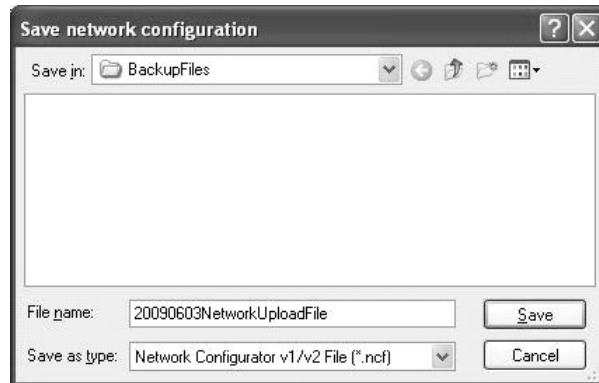

4. Confirm the file save location and file name, and then click the **Save** Button.

The Assign Password Dialog Box will be displayed.



5. Assign the file password and click the **OK** Button.



This completes the uploading procedure.

6. Click the **OK** Button.

The display will return to the Main Window.

9-11 Downloading (Network)

It is possible to obtain and download parameters of devices that are connected online for an entire network.

- 1,2,3... 1. Click **Network Download** Icon in the Main Window.

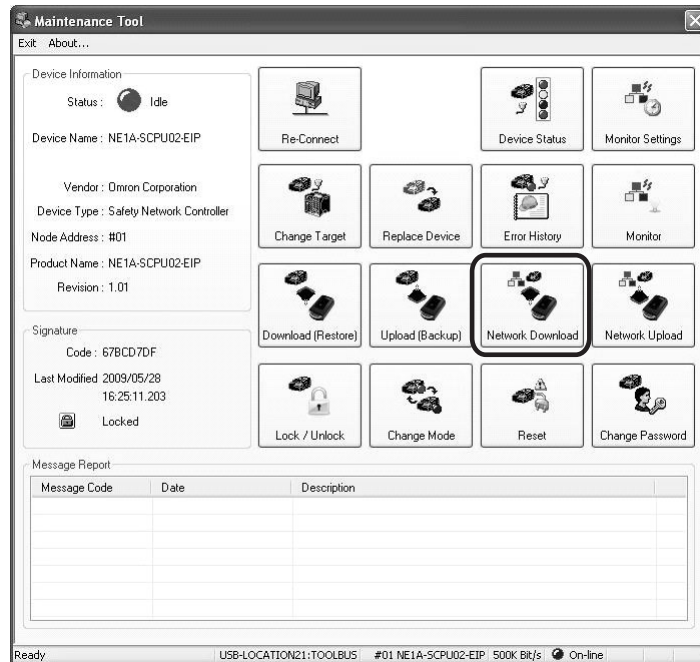

The following dialog box will be displayed.

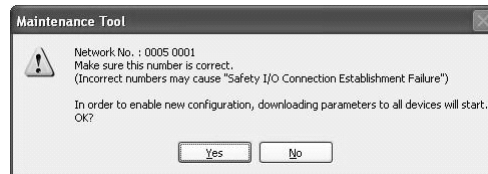

Note Be sure to confirm that the network number is correct. The system may not operate correctly if the devices are configured without the correct network number. Refer to *9-5-2 Specifying the Network Number* for information on network numbers.

2. Confirm the network number, and then click the **Yes** Button.

The following dialog box will be displayed.



3. Specify the network to connect online and click the **OK** Button.

IMPORTANT The network download function is supported only for DeviceNet networks. (EtherNet/IP networks are not supported.)

The Open Dialog Box will be displayed.

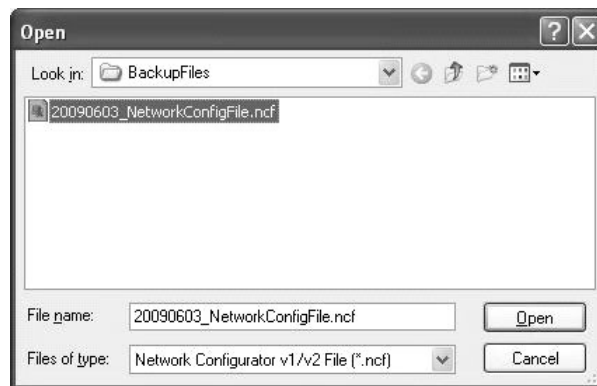

4. Confirm the file save location and file name, and then click the **Open** Button.

The Confirm Password Dialog Box will be displayed.



5. Assign the file password and click the **OK** Button.

The following dialog box will be displayed.

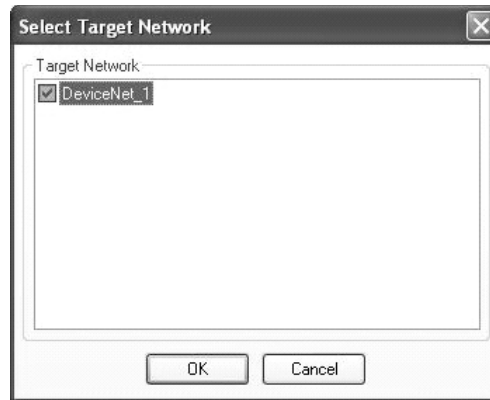

6. Select the network to which to download the parameters and click the **OK** Button.

The Input the Device Password Dialog Box will be displayed.



7. Enter the device password for the device and then click the **OK** Button to start downloading. The following dialog box will be displayed after downloading has been completed.



This completes the downloading procedure.

8. Click the **OK** Button.

The display will return to the Main Window.

Note The device names displayed in the Main Window will not be updated when network downloading has been completed. To update the displayed device names, click the Re-Connect Button.

! WARNING	
<p>Serious personal injury may possibly occur due to loss of safety functions. Observe the following precautions.</p> <p>Perform a user test before operating the system, and check to make sure that all the device configuration data and operations are correct.</p> <p>After replacing a device, check to make sure that the replacement device is in the appropriate configuration and is operating correctly</p>	

9-12 Resetting a Device

This section describes how to reset a Safety Device.

9-12-1 Reset Types

The following three methods can be used to reset a Safety Device.

Reset type	Description
Reboot	This is the same as turning the power OFF and ON.
Reboot and reset configuration	All configuration information saved in the device's nonvolatile memory will be returned to the default values and the device will be restarted.
Reboot and reset configuration without specified items	All configuration information in the device's nonvolatile memory other than specified items will be returned to the default values and the device will be restarted.

The Safety Device saves the following configuration information in nonvolatile memory.

Type	Default setting	Set when	Description
Node address (software setting)	63	Node address is changed.	The node address at startup when software settings are enabled.
Baud rate (software setting)	125 Kbit/s	Baud rate is changed	The baud rate at startup when the software settings are enabled (NE1A-series Controller only).
TUNID (Target Unique Node Identifier)	Not set	First time parameters are downloaded.	The identifier of the local node in the Safety Network consisting of the network number and node address.
Password	No password	Password is changed.	The password for the device.
CFUNID (Configuration Owing UNID)	Not set	First time parameters are downloaded.	The UNID of the configuration source.
OCPUNID (Output Connection Point Owing UNID)	Not set	First time safety communications are started.	The UNID of the Safety Master that opens a safety output connection.

The information above is saved in nonvolatile memory in the device. It will not be cleared by restarting the power supply. To clear the information (to return to the default settings), select the *Reboot and reset configuration* or *Reboot and reset configuration without ... Option* when resetting.

9-12-2 Resetting a Device

- 1,2,3... 1. Click the **Reset** Icon in the Main Window.

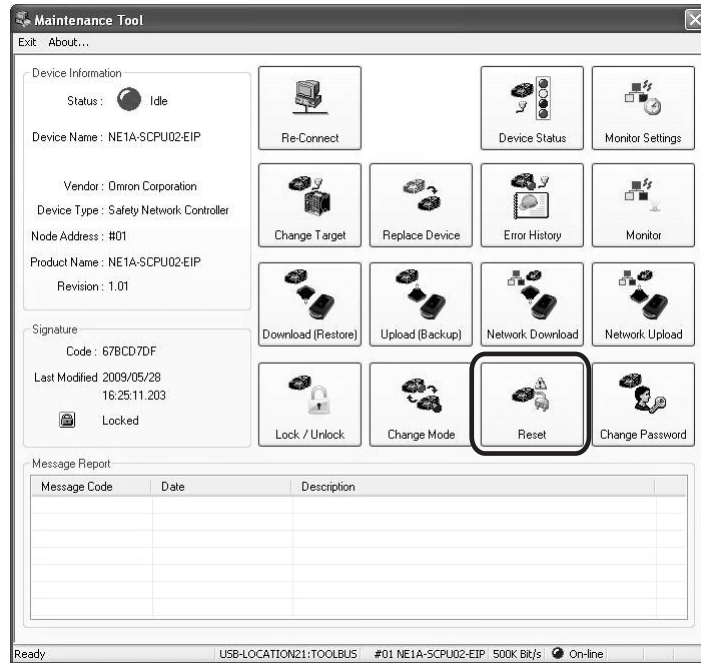

The following dialog box will be displayed.



2. Select the reset type and click the **OK** Button.



This completes the resetting procedure.

3. Click the **OK** Button.
After resetting, the display will return to the Main Window.

- Note** With the Maintenance Tool, it is not possible to set device node addresses with software. It is also not possible to set IP addresses. To reset node addresses or IP addresses that have already been set for devices, select the *Return to the out-of-box configuration, and then emulate cycling power* Option, and then select *Node Address (Software) Settings*.
- Note** The device names displayed in the Main Window will not be updated when resetting has been completed. To update the displayed device names, click the Re-Connect Button.
- IMPORTANT** The network number must be specified when restarting after returning to the default settings. For information on specifying the network number, refer to *9-5-2 Specifying the Network Number*.
- Note** Depending on the reset type and device status, it may not be possible to reset. Refer to the manual for the connected device for reset types and device status.

9-13 Changing the Mode

This section describes how to change the mode of the Safety Device.

- 1,2,3... 1. Click the **Change Mode** Icon in the Main Window.

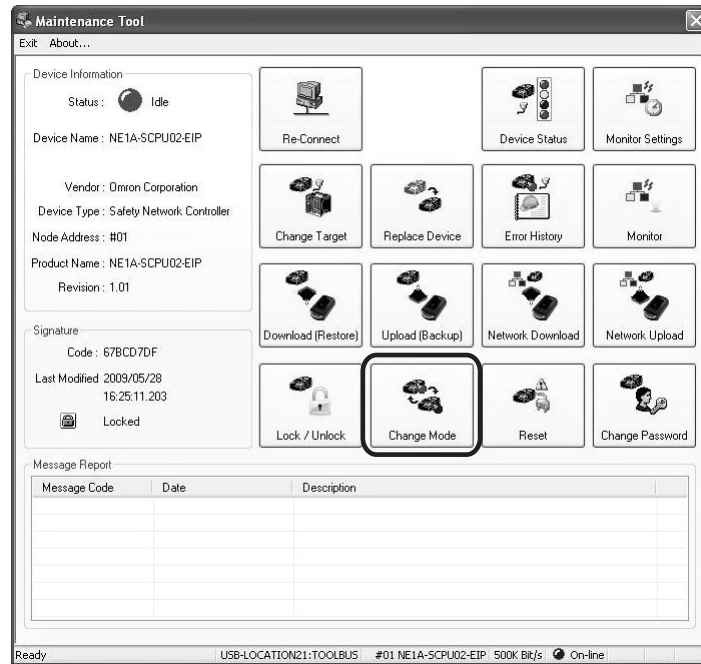

The following dialog box will be displayed.



Note Be sure to confirm that the network number is correct. Safety I/O connections may not be established if the device is configured with the wrong network number. Refer to 9-5-2 *Specifying the Network Number* for information on network numbers.

2. Confirm the network number, and then click the **Yes** Button.

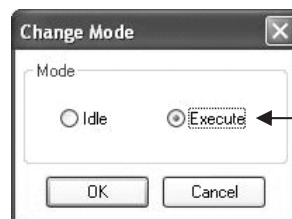

The present mode of the connected device will be displayed. If the present mode is neither Idle nor Execute, no option button will be selected.

3. Select the mode and click the **OK** Button.
The device password input dialog box will be displayed.



4. Enter the password of the connected device and click the **OK** Button.



This completes changing the mode.

5. Click the **OK** Button to return to the Main Window.

Note The mode cannot be changed for a DST1-series Controller.

IMPORTANT The mode cannot be changed for the DST1-XD0808SL-1 if the startup operating mode in the device parameters is set to start execution after establishing safety I/O connections.

9-14 Locking/Unlocking Devices

The configuration of the device connected online can be locked or unlocked.

Note Before locking a configuration, verify safety functionality using a user test with verified configuration data for the target device.

- 1,2,3... 1. Click the **Lock/Unlock** Icon in the Main Window.

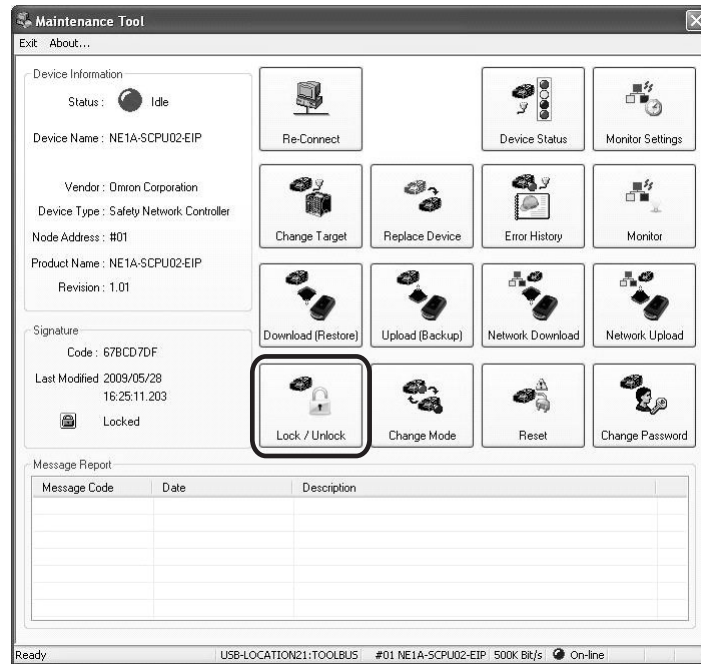

Reading the parameters of the connected devices (i.e., uploading) will start.

The following dialog box will be displayed after uploading has been completed.

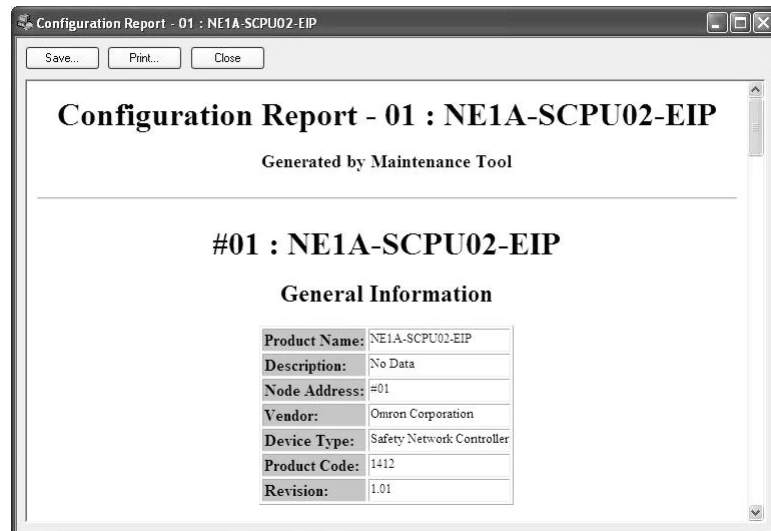

Note This dialog box will not be displayed if the device is locked.

2. Confirm the report information of the device for which the configuration will be locked, and then click the **Close** Button.

One of the following dialog boxes will be displayed.

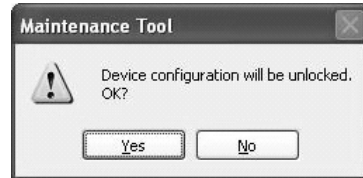
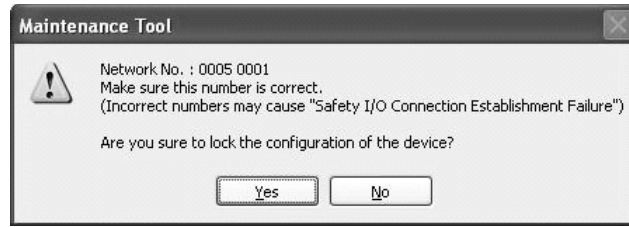

Note When locking the configuration, confirm that the network number is correct.

Note Be sure to check that the network number is correct. If configuration is not performed with the correct network number, Safety I/O connections may not be established. For details on network numbers, refer to 9-5-2 *Specifying the Network Number*.

3. Click the **Yes** Button or the **No** Button.

A dialog box for entering the device password will be displayed when the configuration is locked or unlocked.



4. Enter the password of the connected device and click the **OK** Button. When completed, the display will return to the Main Window.



This completes the lock/unlock procedure.

5. Click the **OK** Button to return to the Main Window.

9-15 Change Passwords

The password of the device connected online can be changed.

- 1,2,3... 1. Click the **Change Password** Icon in the Main Window.

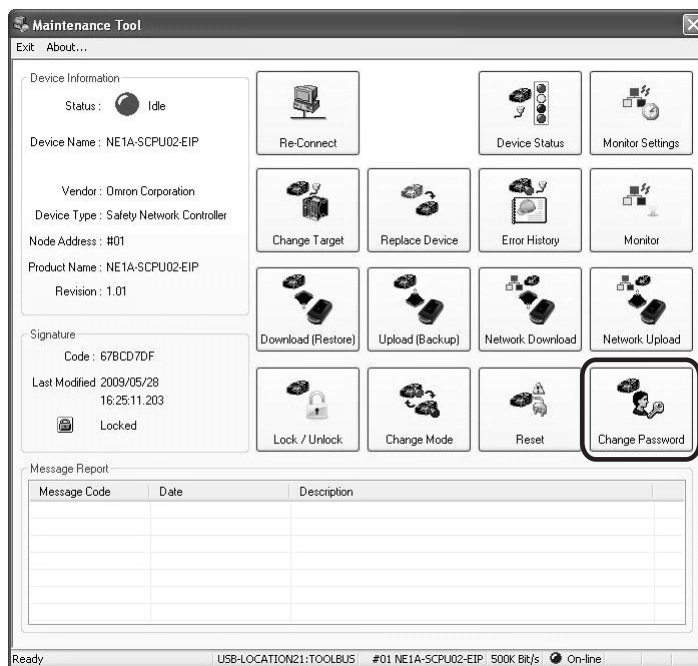

The following dialog box will be displayed.



2. Enter the present device password and the new device password, and then click the **OK** Button.



This completes changing the password.

3. Click the **OK** Button.
The display will return to the Main Window.

Appendix A

A-1 Connecting to the Network via a CS/CJ-series PLC

A-1-1 Connecting to the DeviceNet Network

The Network Configurator can be connected online to the DeviceNet network via a serial communications port on a CS/CJ-series CPU Unit or via a CS/CJ-series DeviceNet Unit, as shown in the following figure. This section describes the procedure.

Refer to *3-4 Connecting to the Network* to connect to the network via the USB port on the NE1A-series Controller, a DeviceNet Interface Card installed in the computer, or an EtherNet/IP port on an NE1A-series Controller that supports EtherNet/IP.

1. Connect the COM port on the computer to a serial communications port on the CS/CJ-series CPU Unit (i.e., the peripheral port or the RS-232C port) or a Serial Communications Board/Unit (i.e., a RS-232C port or a RS-422A/485 port) using a peripheral bus (ToolBus) or Host Link connection. To connect to the DeviceNet network, the PLC must have a CS/CJ-series DeviceNet Unit (i.e., the CS1W-DRM21(-V1) or CJ1W-DRM21).

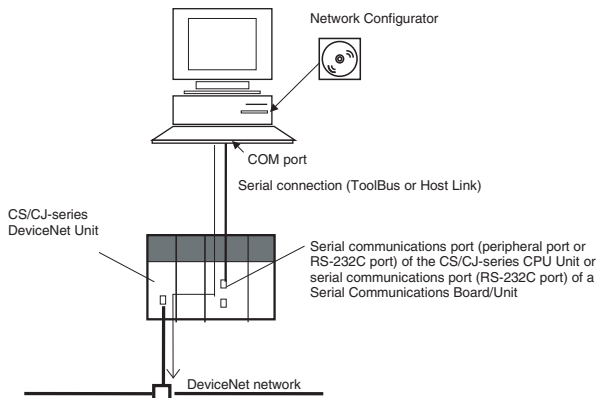

The DeviceNet can be connected to crossing multiple network layers (3 layers max.) using serial communications, as shown in the following figure.

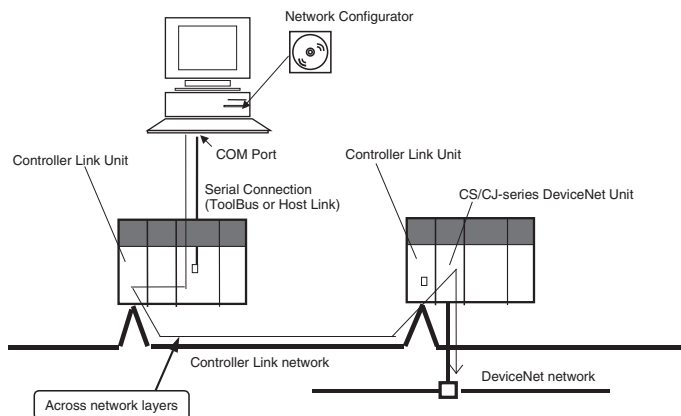

- Connect the Ethernet port of the computer to a CS/CJ-series Ethernet Unit. To connect to the DeviceNet network, the PLC must have a CS/CJ-series DeviceNet Unit (i.e., the CS1W-DRM21(-V1) or CJ1W-DRM21).

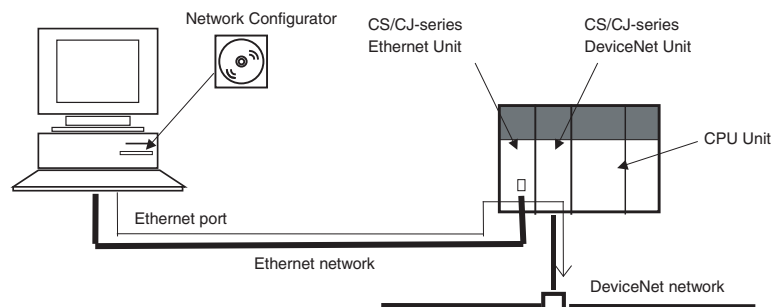

The DeviceNet network can be connected to crossing multiple network layers (3 layers max.) using Ethernet, as shown in the following figure.

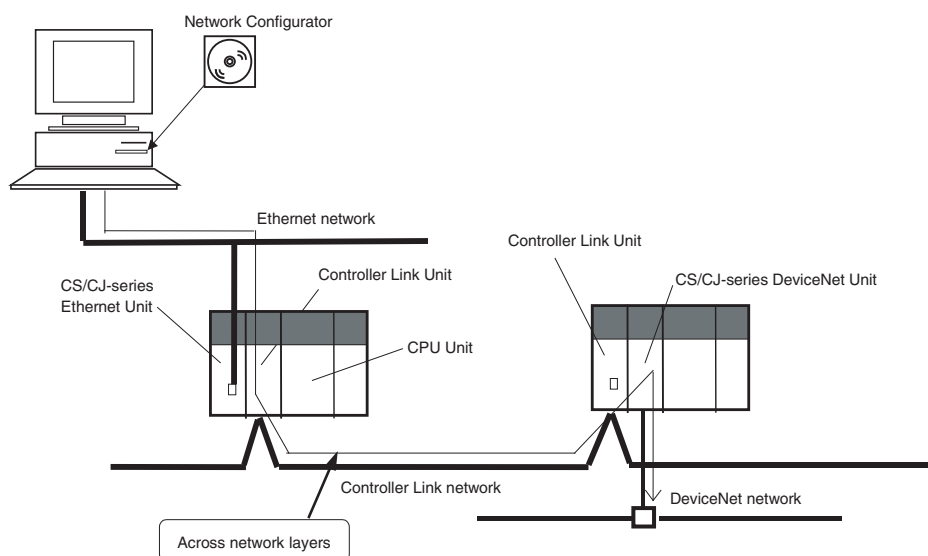

A-1-2 Specifying the Connection Interface

Use the following procedure to specify the connection interface to use.

Note Specify the connection interface whenever specifying an online connection.

- Select **Option - Select Interface** from the menu bar.
(The interface currently used will be selected.)
- Select an interface to use from those displayed on the submenu.
 - Serial Port: Select **CS/CJ Serial Port -> DRM Unit I/F**.
 - Ethernet Unit: Select **Ethernet -> CS/CJ ETN-DRM Unit I/F**.
- Select **Network - Connect** from the menu bar.
The window corresponding to the specified connection interface will be displayed.
Refer to *Specifying the CS/CJ Serial Port -> DRM Unit I/F as the Connection Interface* on page 295 or *Specifying the Ethernet -> CS/CJ ETN-DRM Unit I/F as the Connection Interface* on page 299 for the procedure.
Refer to *Specifying the CS/CJ Serial Port -> DRM Unit I/F as the Connection Interface* on page 295 or *Specifying the Ethernet -> CS/CJ ETN-DRM Unit I/F as the Connection Interface* on page 299 for the procedure.

Note The interface cannot be changed while the Network Configurator is online. Select **Network - Disconnect** and then change the interface offline.

Specifying the CS/CJ Serial Port -> DRM Unit I/F as the Connection Interface

(Continued from step 3 on the previous page.)

1. When **CS/CJ Serial Port -> DRM Unit I/F** is selected as the connection interface, the Setup Interface Dialog Box will be displayed. An example is shown below.

Set each item as described below.

Interface

Select either one of the following interfaces as the serial communications mode for the serial communications port on the CS/CJ-series PLC.

- Peripheral bus (ToolBus)
- Host Link

Network Address

Enter the FINS network address of the destination DeviceNet Unit. Enter this address when crossing the network farther than the serial communications port of the CS/CJ-series CPU Unit. Enter 0 when not crossing network layers.

Node Address

Enter this address when crossing the network farther than the serial communications port of the CS/CJ-series CPU Unit. Enter 0 when not crossing network layers.

CPU Bus Unit Number

Enter the unit number of the DeviceNet Unit (i.e., the CS1W-DRM21(-V1)) as a CPU Bus Unit (i.e., the value set on the rotary switches on the front of the DeviceNet Unit).

- The unit number is between 0 and 15.

Communications Port

Select the COM port on the computer running the Network Configurator (version 2.□).

- Select from the list of available COM ports.

Baud Rate	<p>Set the baud rate for the serial communications port on the CS/CJ-series PLC.</p> <ul style="list-style-type: none"> • 9,600, 19,200, 38,400, or 115,200 bit/s. <p>Note The baud rates that can be selected for the peripheral bus (ToolBus) and Host Link are different. For details, refer to the <i>CS/CJ Series Operation Manual</i>.</p>
Data Length	<p>Set the data length for the serial communications port on the CS/CJ-series PLC. This setting is required only when using the Host Link interface.</p> <ul style="list-style-type: none"> • 7 or 8 bits
Parity	<p>Set the parity for the serial communications port on the CS/CJ-series PLC. This setting is required only when using the Host Link interface.</p> <ul style="list-style-type: none"> • None, even, or odd
Stop Bits	<p>Set the number of stop bits for the serial communications port on the CS/CJ-series PLC. This setting is required only when using the Host Link interface.</p> <ul style="list-style-type: none"> • 1 or 2 bits

IMPORTANT Always select the peripheral bus (ToolBus) interface when making a serial connection through the CS1W-CN226/626 or the XW2Z-200S-CV/500S-CV Connecting Cable to a CS-series PLC with the CS1W-DRM21(-V1) mounted to the CPU Rack. A connection will not be possible if the Host Link interface is selected.

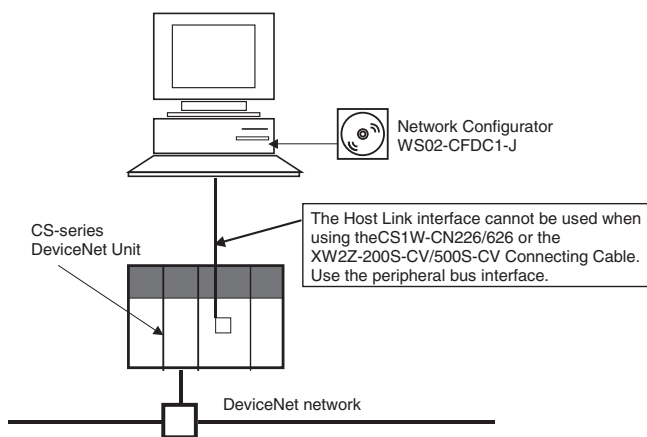

- Note**
- (1) For information on the FINS node address, refer to the *CS/CJ-series DeviceNet Unit Operation Manual* (W380).
 - (2) When **Host link** is selected, it may take several minutes to download from the network. It is recommended to select the *Peripheral Bus (ToolBus)* for the serial connection.

Downloading from a Serial Port on a CS/CJ-series CPU Unit via DRM Unit Interface or from an Ethernet Unit via CS/CJ ETN-DRM Unit Interface

This section describes how to download data to DeviceNet/Safety devices via a CS/CJ-series PLC.

1. Changing the Message Timer of the CS/CJ-series CPU Unit

(1) Right-click the CJ1 and select **Parameter - Edit** from the displayed menu.

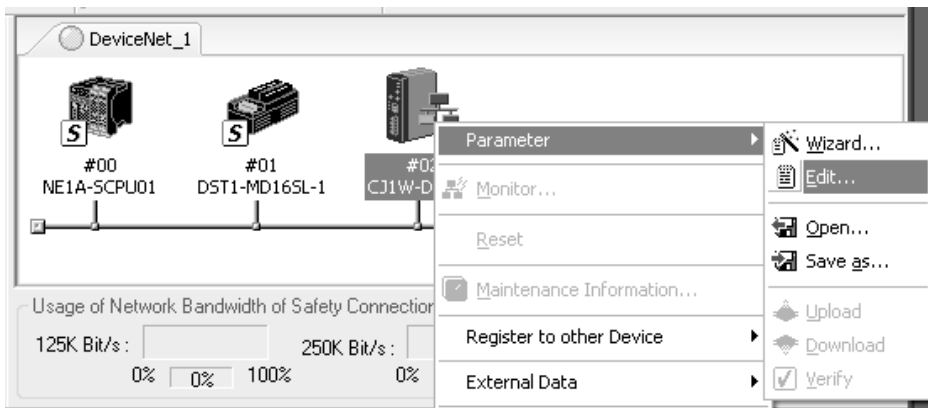

(2) Select the **Message Timer** Tab in the Edit Device Parameters Window and set the timer value to 10000 (ms) (i.e., 10 s) for the device to be downloaded from. (It is not necessary to change the node numbers of devices for which data is not to be downloaded.)

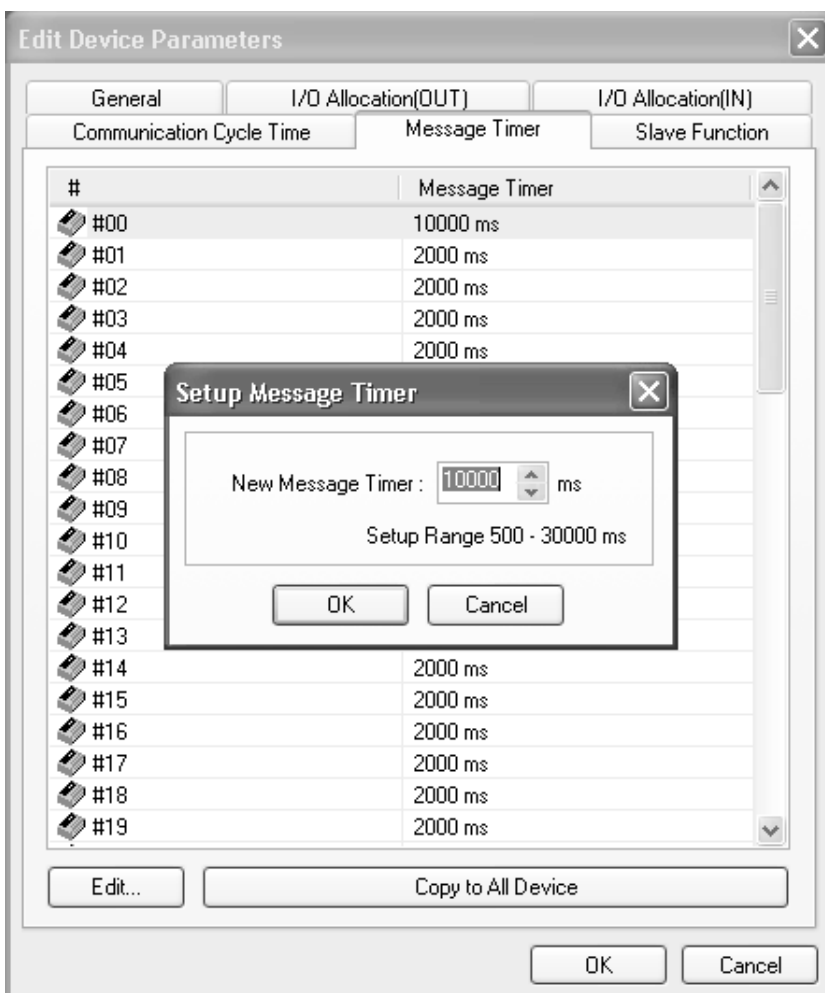

(3) The data with changed settings will be downloaded to the CJ/CS-series CPU Unit.

2. Stopping Remote I/O Communications of the CS/CJ-series CPU Unit

(1) Right-click the CS/CJ-series CPU Unit and select **Monitor** from the displayed menu.

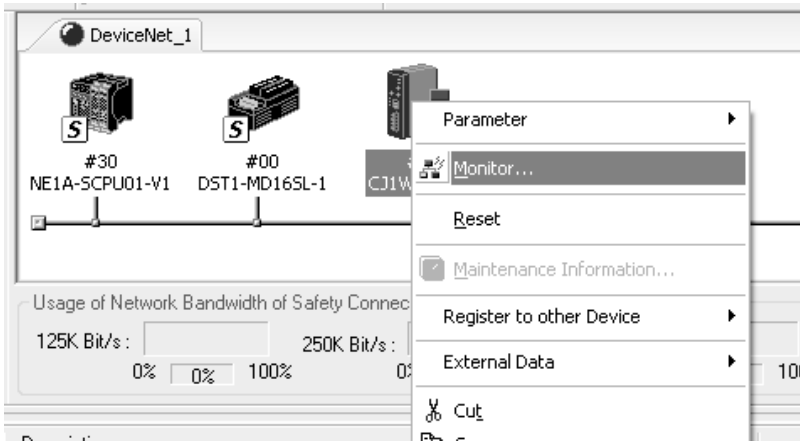

(2) Click the *Stop Remote I/O Communication* Option on the *Status* Tab Page.

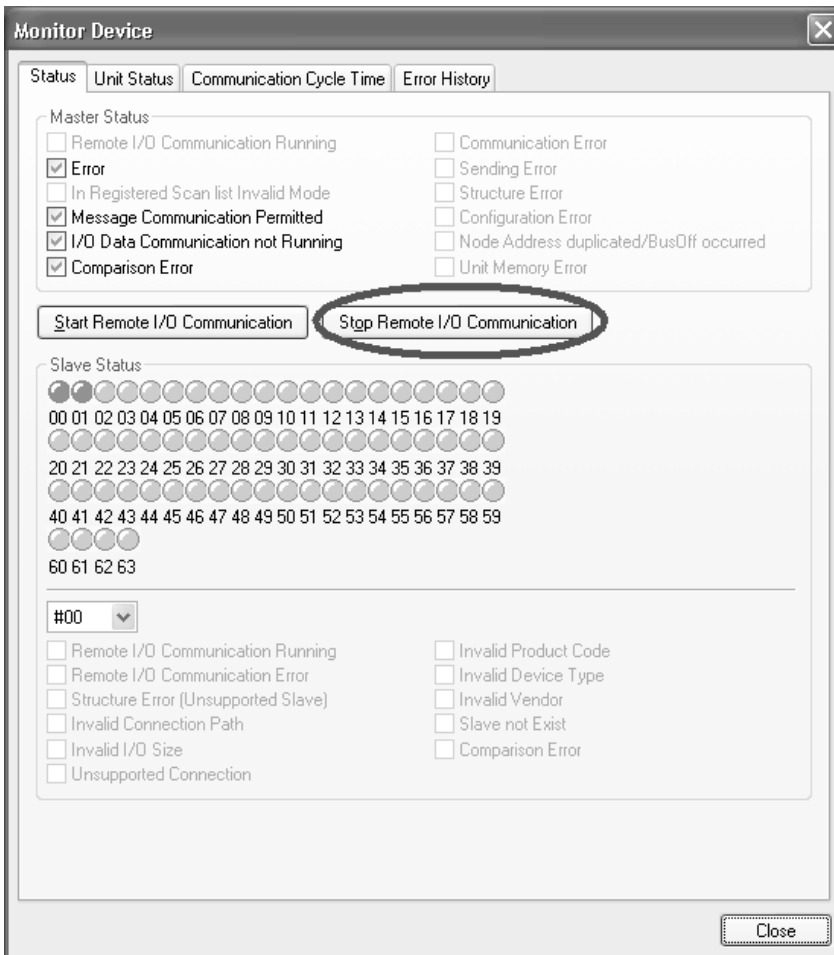

Once the steps above have been completed, downloading to DeviceNet/Safety devices will be performed.

Specifying the Ethernet -> CS/CJ ETN-DRM Unit I/F as the Connection Interface

The user can connect the computer (i.e., the Network Configurator) directly to an Ethernet network and connect online to the DeviceNet network using a CS/CJ-series Ethernet Unit and CS/CJ-series DeviceNet Unit.

Note Connection via Ethernet is supported only when using both the CS/CJ-series Ethernet Unit and the CS/CJ-series DeviceNet Unit. (This connection is not possible if Units from any other PLC Series are used.)

When multiple PLCs with both Ethernet Units and DeviceNet Units are connected to the Ethernet network, the specified DeviceNet network can be connected to online by switching the connection destination. The destination DeviceNet network is registered by specifying the IP address of the Ethernet Unit and the unit number of the DeviceNet Unit.

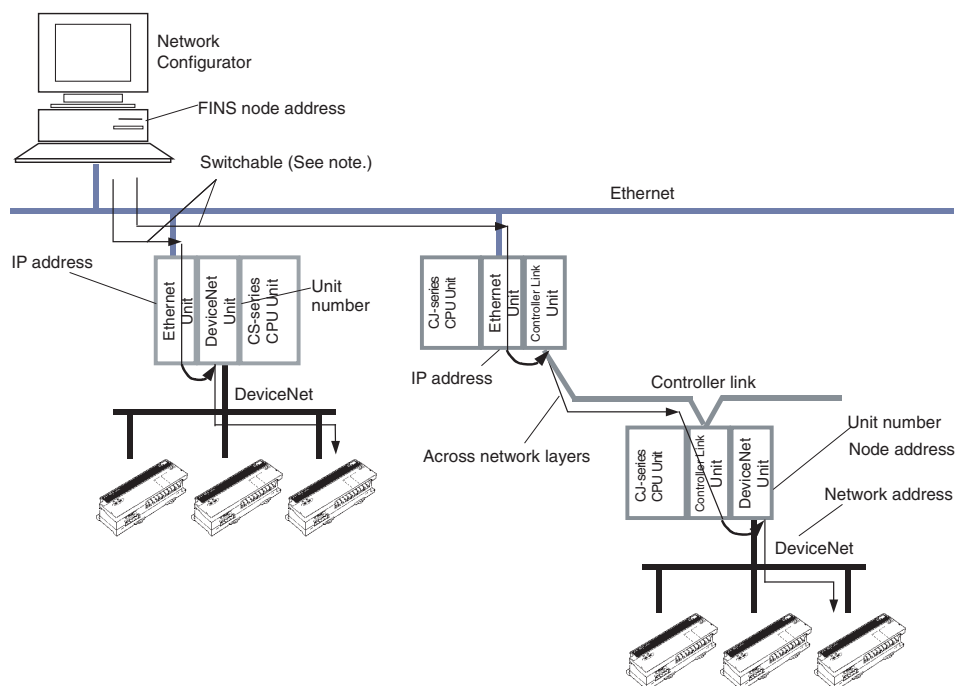

Note The registered name of the destination DeviceNet network can be specified to switch the destination DeviceNet network. The name of the destination DeviceNet network can be registered by specifying the following items.

- IP address and UDP port number of the Ethernet Unit
- Network address, node address, and CPU Bus Unit unit number of the DeviceNet Unit
- FINS node address of the computer (i.e., the Network Configurator)

Registering Destination DeviceNet Networks

It is necessary to register the destination DeviceNet network in advance for a connection via Ethernet. A maximum of 20 DeviceNet networks can be registered.

Use the following procedure to register the destination DeviceNet network.

1. Select **Network - Connect**.
2. The following window will be displayed.

Interface Setting Window

Host (PC) Information	Settings of the computer running the Network Configurator are displayed.	
	Host Name	The name of the computer is displayed automatically.
	IP Address	The IP address of the computer is displayed automatically.
	Network Address	The FINS network address set in the computer is displayed. (The value set in the Destination Registration Window after clicking the Set Button in step 3 below will be displayed.)
	Node Address	The FINS node address set in the computer is displayed. (The value set in the Destination Registration Window after clicking the Set Button in step 3 below will be displayed.)

- Click the **Set** Button. The Destination Registration Window will be displayed. An example is shown below.

Destination Registration Window

Registration Name	Set the registered name of the destination DeviceNet network. Up to 20 names can be registered. A registration name can use up to 25 characters.		
Host (PC) Information	Network Address	Enter the FINS network address of the computer. Set the same value as the network address of the Ethernet Unit. Enter 0 to not set a network address.	
	Node Address	Enter the FINS node address of the computer.	
Remote Information	Setting items for the DeviceNet and the Ethernet Unit that relay the connection to the DeviceNet Network.		
	DeviceNet Unit	Network Address	Enter the FINS network address of the destination DeviceNet Unit. Enter an address here to cross the network farther than the Ethernet network directly connected to the computer. Enter 0 when not crossing network layers.
		Node Address	Enter the node address of the destination DeviceNet Unit. Enter an address here to cross the network farther than the Ethernet network directly connected to the computer. Enter 0 when not crossing network layers.
		CPU Bus Unit Number	Enter the unit number of the destination DeviceNet Unit as a CPU Bus Unit.
	Ethernet Unit	Port Number	Enter the UDP port number for the FINS of the Ethernet Unit.
IP Address		Enter the IP address of the Ethernet Unit.	

Setting the Network Address in the Host (PC) Information Area

Set the FINS node address of the computer.

The computer (i.e., the Network Configurator) uses the OMRON FINS communications service to connect to the DeviceNet network via the Ethernet. It is necessary to set the FINS node address as well as the IP address.

For the network address, set the same value as the Ethernet Unit. The network address of the Ethernet Unit is set in the routing table of the CPU Unit. Enter 0 when not using the routing table.

Setting the Node Address in the Host (PC) Information Area

Set the FINS node address of the computer.

For this setting, it is necessary to set the correspondence between the remote IP address and the FINS node address using the OMRON Ethernet Unit. For details, refer to the *SYSMAC CS/CJ Series Ethernet Unit Operation Manual* (W420, W421 and W343).

Setting the Network Address in the *DeviceNet Unit* Field of the Remote Information Area

Set the FINS network address of the DeviceNet Unit to which the destination DeviceNet network is connected. Enter the value when crossing the network farther than the Ethernet network directly connected to the computer. Enter 0 when not crossing network layers.

Setting the Node Address in the *DeviceNet Unit* Field of the Remote Information Area

Set the Node Address of the DeviceNet Unit to which the destination DeviceNet network is connected.

Enter the value when crossing the network farther than the Ethernet directly connected to the computer. Enter 0 when not crossing network layers.

Setting the CPU Bus Unit Number in the *DeviceNet Unit* Field of the Remote Information Area

Set the unit number (0 to F) of the DeviceNet Unit as a CPU Bus Unit to which the destination DeviceNet network is connected.

Setting the Port Number in the *Ethernet Unit* Field of the Remote Information Area

Set the UDP port number with which the Ethernet Unit performs the FINS Communications Service. Set the same value as in the setting in the CPU Bus Unit System Setting Area in the CPU Unit to which the Ethernet Unit is mounted. Normally 9600 is used.

Setting the IP Address in the *Ethernet Unit* Field of the Remote Information Area

Set the IP address of the Ethernet Unit.

To set the IP address of the Ethernet Unit, refer to *SYSMAC CS/CJ Series Ethernet Unit Operation Manual* (W420, W421 and W343).

4. Click the **Register** Button. The set values will be registered and displayed in the Registration List.
 - Name: Registration name of the destination DeviceNet network
 - Node: FINS network address and FINS node address (the third number is always 0) of the computer
 - Unit: FINS network address, FINS node address, and unit number of the DeviceNet Unit
 - Port: FINS UDP port number of the Ethernet Unit
 - IP Address: IP address of the Ethernet Unit
5. Click the **Close** Button to exit and return to the Setup Interface Window.

Selecting the Registration Name (Destination DeviceNet Network)

Select the DeviceNet network that you want to connect from the registration names of the registered connection destinations in the Setup Interface Window.

1. Select the destination registration name from the *Registration Name* Drop-down List in the *Remote Information Area*.
In the *Remote Information Area*, the following set values of the selected registration name will be displayed.
 - Network Address: FINS network address of the DeviceNet Unit
 - Node Address: Node address of the DeviceNet Unit
 - CPU Bus Unit Number: Unit number of the DeviceNet Unit
 - Port Number: FINS UDP port number of the Ethernet Unit

- IP Address: IP address of the Ethernet Unit
2. Click the **OK** Button.
Click the **OK** Button in the confirmation dialog box.
The connection to the DeviceNet network will be made.
When the connection is successful, the status indicator on the status bar will turn blue and “On-line” will be displayed.
- Note** For information on FINS network addresses and FINS node addresses, refer to the *CS/CJ Series DeviceNet Unit Operation Manual (W380)* and the *SYSMAC CS/CJ Series Ethernet Unit Operation Manual (W420, W421 and W343)*.

A-2 Editing CS/CJ-series DeviceNet Unit Parameters

This section describes how to edit the parameters of a CS/CJ-series DeviceNet Unit.

A-2-1 Setting the Unit Functions

The master function and slave function can be set.

Follow the procedure below to perform the settings.

1. Select the icon of the master in the Network Configuration Pane.
2. Select **Device - Property**.
The following window will be displayed. Click the **Unit Function** Tab.

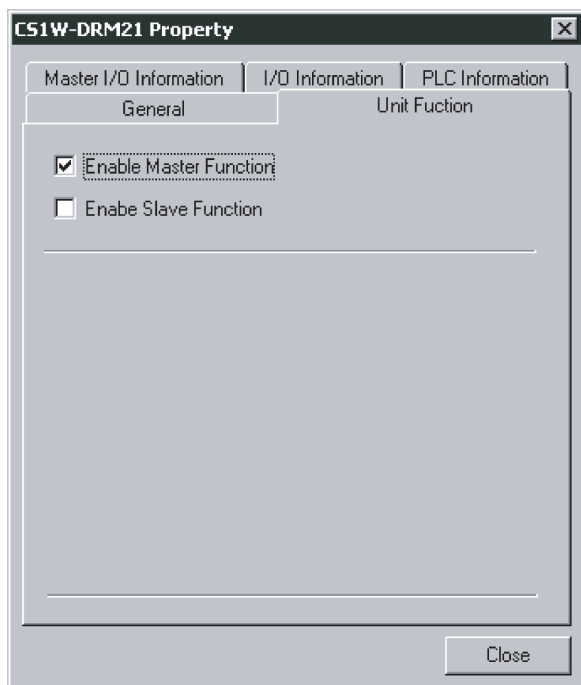

3. Select the *Enable Master Function* or *Enable Slave Function* Option (or both).

A-2-2 Master Parameter Overview

Use the following procedure to open the Parameter Edit Window.

1. Select the device for which you want to edit the parameters.
2. Select **Device - Parameter - Edit**.
3. The Edit Device Parameters Window for the master will be displayed.

Note (1) If the I/O size of the device displayed in the Network Configuration Pane and the I/O data size of the device registered in the Scan List do not match, the following warning dialog box will be displayed and the I/O size set in the Scan List will be given priority.



If there is a slave with no EDS installed, obtain an EDS and install it.

- (2) If a slave device registered to another master device is registered in the Scan List, the following warning message will be displayed when the Edit Device Parameters Window is displayed.

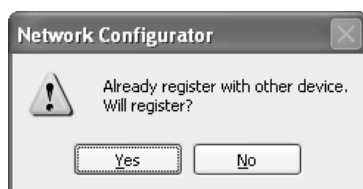

Modify the registered slave in the Scan List.

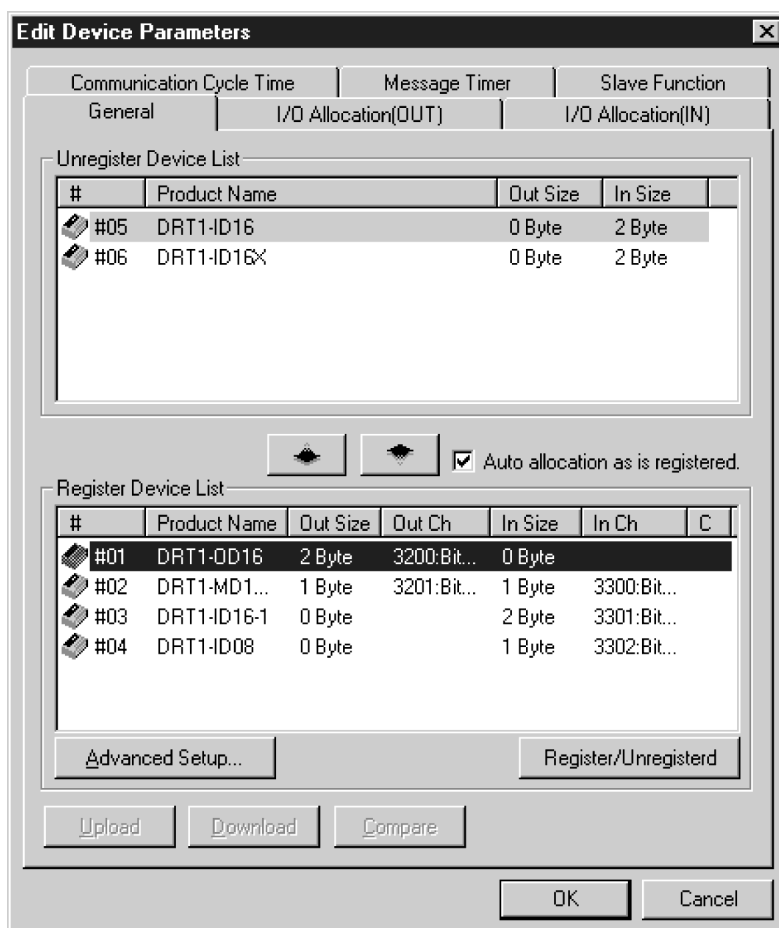

- (3) To operate the master function, select a device, select **Device - Properties**, and then select the Enable Master Function Option in the Property Dialog Box of the CS1W-DRM21(-V1)/CJ1W-DRM21.



The Edit Device Parameters Window consists of the following 6 tab pages.

Tab page name	Description
General	Registers devices in the Scan List and performs I/O allocations using automatic setting.
I/O Allocation (OUT)	Sets the OUT data allocation and OUT memory block of the CPU Unit using the Advanced Setup.
I/O Allocation (IN)	Sets the IN data allocation and IN memory block of the CPU Unit using the Advanced Setup.
Communication Cycle Time	Sets the communications cycle time.
Slave Function	Sets parameters for using the slave function.
Message Timer	Set the monitoring timer for message communications (the same time is used for both explicit and FINS message communications).

General Tab Page

Item	Description
Unregistered Device List	Displays the slave devices displayed in the Network Configuration Pane but not yet registered to a master.
Registered Device List	Displays slave devices currently registered to the master.
Device Register and Unregister Buttons	 Use the Device Register Button to move a device from the Unregistered Device List above to the Registered Device List below.  Use the Device Unregister Button to move a device from the Registered Device List below to the Unregistered Device List above.
Auto allocation as is registered	Select this option to allocate unused words in the registration order when registering slaves to a master in the Edit Device Parameters Window.
Register/Unregister Button	Click this button to cancel and re-allocate the I/O allocations (allocation of unused words with no unallocated words) to the selected slave.
Advanced Setup Button	Click this button to set the connection settings and to display or check device information.
Upload Button	Click this button to upload online device parameters from devices in an actual network.
Download Button	Click this button to download online device parameters to devices in an actual network.
Verify Button	Click this button to verify online parameters of devices in an actual network and the parameters held by the Network Configurator.

Slave Registration and Automatic I/O Area Allocation

If a slave is registered when the master function is enabled, words are automatically allocated to it in the memory block set for I/O allocation.

Allocation is performed forward from the beginning of Memory Block 1 in the order of registration for both the input and output areas. When Memory Block 1 is completely allocated, allocation is performed in Memory Block 2. Set the areas and ranges of the memory blocks for allocation in advance before registering slaves.

Note Auto-allocation areas can be changed later.

Setting Memory Blocks for Allocation

1. Select a master and then select **Device – Parameter – Edit**. The Edit Device Parameter Dialog Box will be displayed.
2. Click the **I/O Allocation (OUT)** Tab.

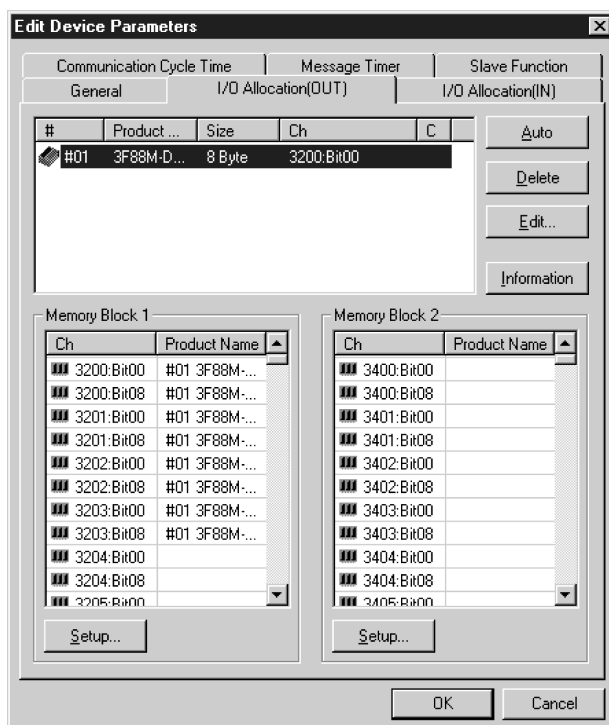

3. Click the **Setup...** Button in the Memory Block 1 Area.
4. Set the **Area**, **Start Word**, and **Display Words** (i.e., the number of words in) for Memory Block 1.

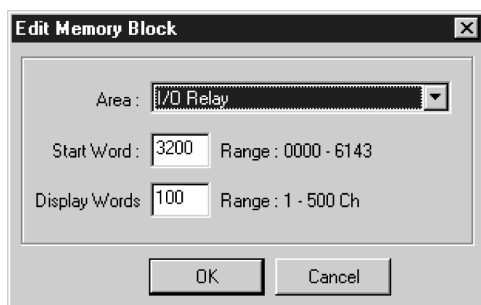

5. Set Memory Block 2 in the same way.
6. Click the **I/O Allocation (IN)** Tab and set the Memory Blocks in the same way as the OUT block.

Note (1) Set the Area setting for unused blocks to *Not Use*.

- (2) The number of displayed words is the number of words of a block displayed in the Network Configurator. This value is not downloaded to the Unit. If the allocated area in a block is 100 words or less when uploaded, the number of displayed words will be set to 100 and displayed.

Specifying Auto-allocation at Registration

- If the option for auto-allocation (*Auto-allocation as is registered*) is selected, words will be allocated for I/O automatically in the order of registration when slaves are registered to a master in the Edit Device Parameters Window. This option is effective only in the Edit Device Parameters Window. Auto-allocation allocates words starting from unused words in Block 1 of the corresponding I/O memory block in the order of registration (i.e., in the order slaves are dropped).
- Deleting or changing I/O allocations for the selected slaves (allocating unused word) can be performed anytime by clicking the Auto Register/Unregister Button.

A-2-3 I/O Allocation Using the Parameter Wizard (Simple I/O Allocation)

- I/O in PLC memory can be allocated to slaves simply and interactively.
- I/O allocation is as follows: In order of node addresses, simple I/O allocation from Block 1, and I/O allocation of 100-word blocks.

Allocation is performed in the order of slave node addresses from Block 1 (allocating from Block 2 when Block 1 is completely allocated) with a block size of 100 words.

Note After allocating I/O using this wizard, node addresses can be changed and other allocation changes can be made in the *Editing Parameters*, as described later.

The Parameter Wizard specifies the beginning address of each block (the block size is always 100 words), the allocation method (allocation by word or minimum allocation of unused words), and slave registration or deletion.

- Note**
- (1) Allocate areas larger than 100 words for each block in *Editing Parameters*.
 - (2) Use the following procedure to allocate I/O to the slave devices of a master device with the Parameter Wizard.

1. Select the master device to register.
2. Select **Device - Parameter - Wizard**.
3. Click the **Yes** Button.

The present settings will all be initialized if the Parameter Wizard is used for the setup. A confirmation dialog box will be displayed. An example is shown below.

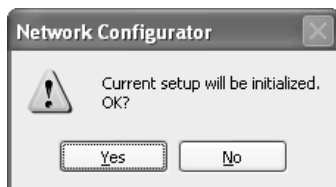

4. Setting the Start Word for Each Block
The Scan List Wizard-Setting Memory Block's Start Word Window will be displayed. An example is shown below.
Set the memory areas to use and the start words, and then click the **Next** Button. Allocation starts automatically from Block 1. If Block 1 is completely allocated, allocation will be performed in Block 2. Each block will be allocated from the start word to a maximum of 100 words (fixed).

Note If an area overlaps blocks or the start word results in exceeding the memory area range, you cannot move to the next step.

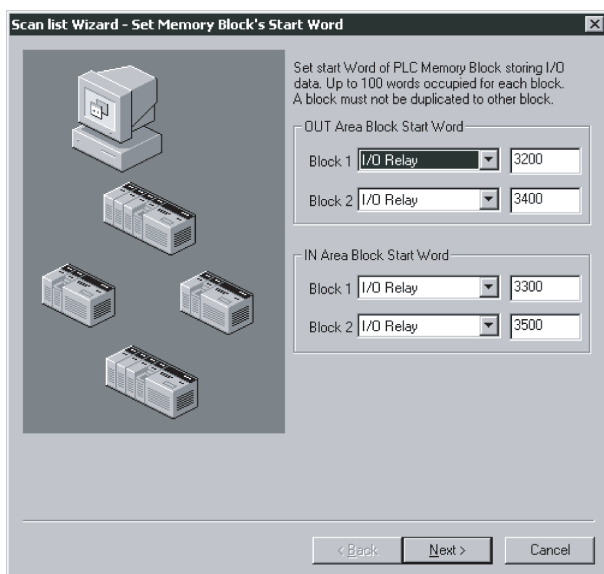

5. Setting Remote I/O Allocations

The Scan List Wizard-Set how to allocate I/O data to PLC Memory Block Window, which specifies the I/O data allocation method for devices, will be displayed. An example is shown below. Specify the allocation method and click the **Next** Button.

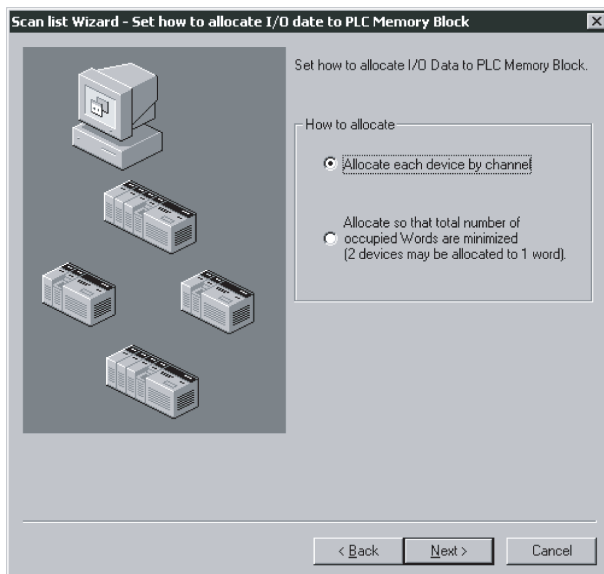

There are two methods for allocation.

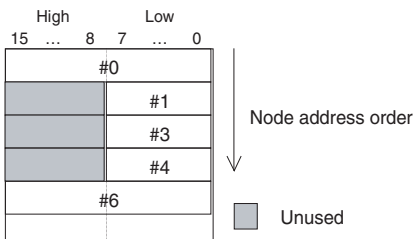
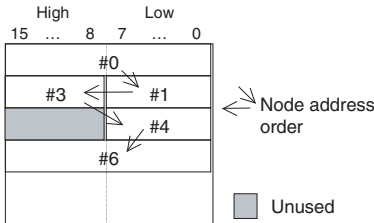
<p>Allocate each device by channel</p>	<p>Each slave is always allocated the low byte (lower 7 bits) of the word. Therefore, each slave is allocated one word even if 1-byte I/O slaves come sequentially.</p> <p>Example:</p> 
<p>Allocate so that the total number of allocated words is minimized (two devices may be allocated to one word)</p>	<p>If there are 1-byte I/O slaves, allocation is in the order of low byte (lower 7 bits) to high byte (upper 7 bits) to create as few unused areas as possible.</p> <p>Example:</p> 

Examples of allocation are as follows:

Allocation when outputs or inputs are as shown below

- #00 1 byte
- #01 2 bytes
- #02 1 byte
- #03 4 bytes
- #04 1 byte
- #05 1 byte

Allocation by Word

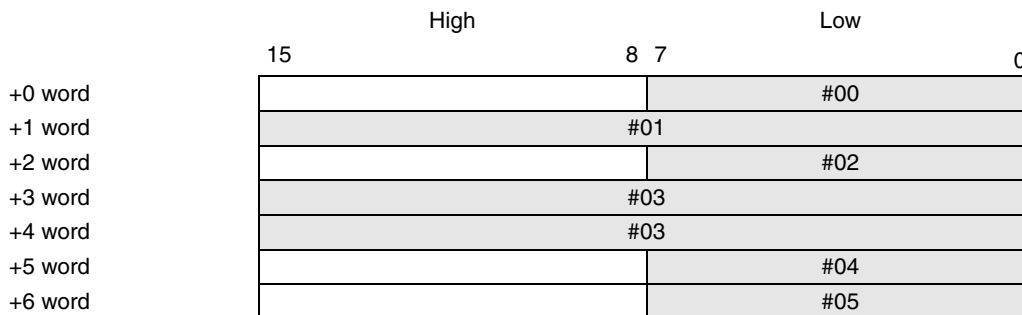

Allocation Minimizing the Number of Allocated Words

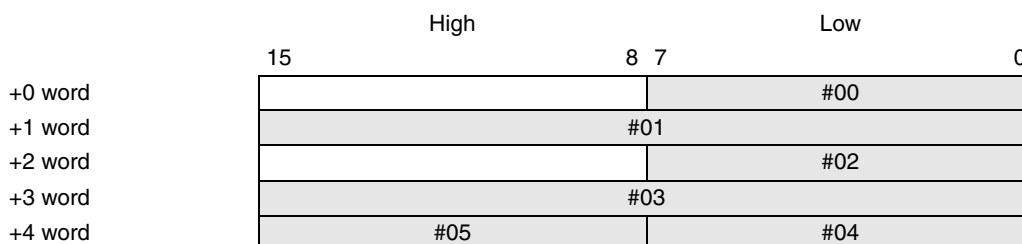

6. Slave Registration and Deletion

The Scan List Wizard-Register Device Window will be displayed.

An example is shown below. Specify the slave devices to register to the master device and click the **Next** Button.

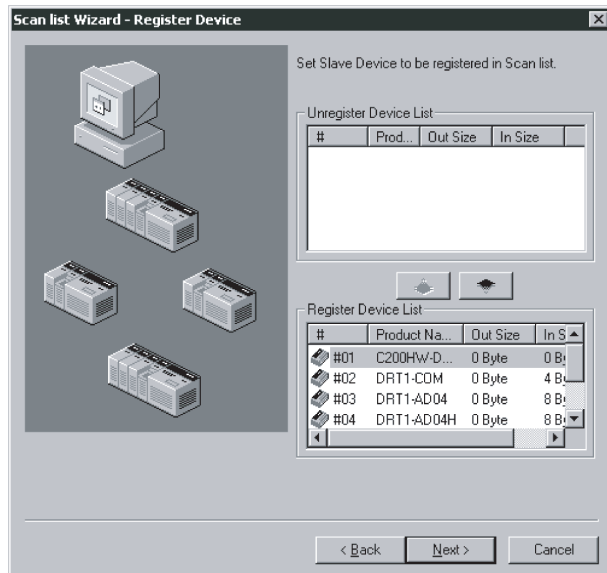

Devices in the network will be displayed in the Registered Device List as already registered. If there is a device that you do not want registered, click the  Button to unregister it. You cannot go on to the next step if there are no registered devices.

7. Displaying Remote I/O Allocation Results

After allocating I/O with the specified method, the Scan List Wizard-Allocation Result Window will be displayed. An example is shown below. If the displayed details are correct, click the **Finish** Button. This exits the Parameter Wizard. Click the **Back** Button to go back to the previous setting pages.

The set contents will be set as device parameters.

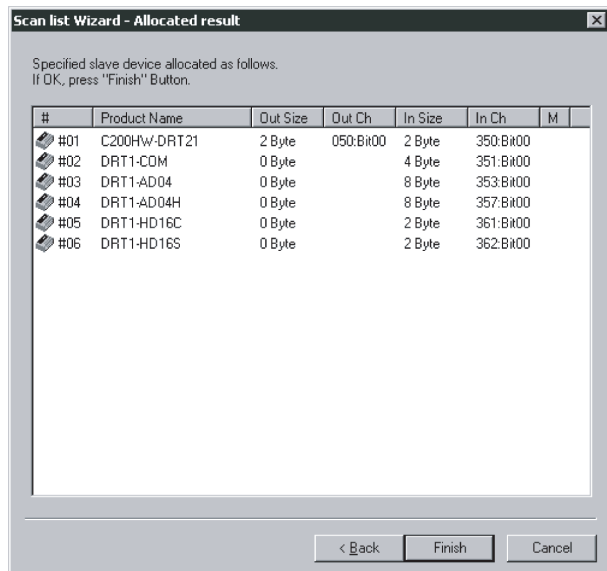

8. Downloading Parameters to a Master Device

The following dialog box will be displayed when the Network Configurator is online.



If you click the **Yes** Button to download to a master device, the remote I/O communications will start with the new settings.

Note Device parameters set in the Parameter Wizard can be changed using the parameter edit function.

A-2-4 Manual I/O Allocation

Memory can be manually allocated for slave I/O.

I/O Allocation Tab Page

The following items are set on the I/O Allocation Tab Page.

1. Allocation of I/O memory in the CPU Unit for I/O Memory Blocks 1 and 2
2. Allocation to slaves for each block

The following window will be displayed when you click the **I/O Allocation (OUT)** or **I/O Allocation (IN)** Tab.

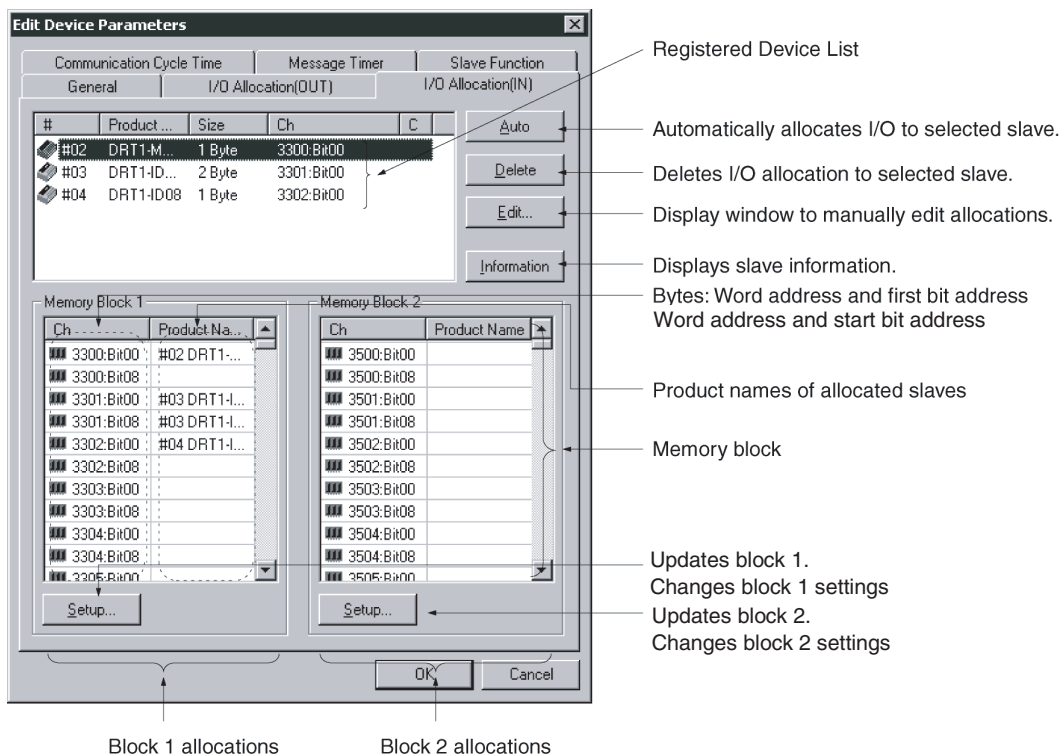

Item	Description
Registered Device List	Displays only devices with valid output or input data of the registered devices on the General Tab Page.
Auto Button	Allocates unused words to the slaves selected in the Registered Device List starting from the first unused words.
Delete Button	Releases the words allocated to the selected slaves in the Registered Device List.

Item	Description
Edit Button	Enables manually editing allocations using the Edit Window.
Information Button	Displays the slave information (allocated words and I/O comments).
Memory Blocks 1 and 2	Displays the allocation state of each slave (product name) in Blocks 1 and 2.
Ch	Beginning of allocation. The start bit address is displayed after the word address.
Product Name	The name of the device to which memory is allocated.
Setup Button	Sets the start words and size (number of words) of Blocks 1 and 2.

Additional Information: Allocation State of Blocks 1 and 2

The product name of the device to which memory is allocated in each area and the first CPU Unit word allocated are displayed in the Allocation State List for the blocks.

The first bit that is allocated is given in the *Ch* column. The word address is given first followed by the first bit.

Example: “3300: Bit 00” indicates that the first allocated bit is bit 00 of CIO 3300 (i.e., the allocation starts from the low byte).

Example: “3300: Bit 08” indicates that the first allocated bit is bit 08 of CIO 3300 (i.e., the allocation starts from the high byte).

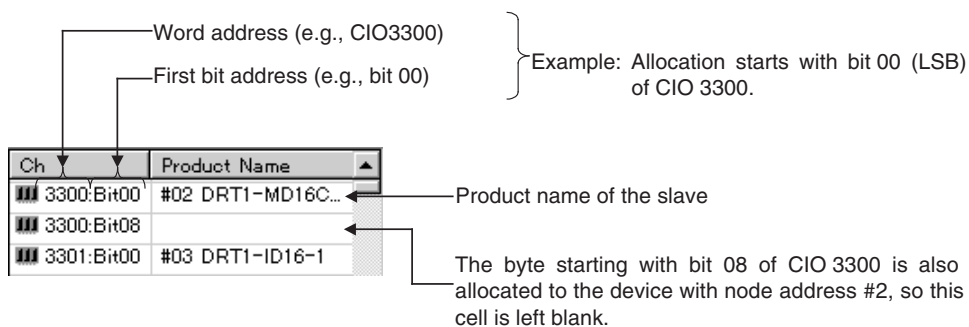

CPU Unit words are not displayed in unused memory block.

Changing the I/O Block Start Word

Setup Button on the I/O Allocation Tab Pages (*Device - Parameter - Edit*)

Use the following procedure to change the allocation areas for the I/O blocks in CPU Unit I/O memory.

1. Click the **Setup** Button of the block to change.
2. The following dialog box will be displayed.

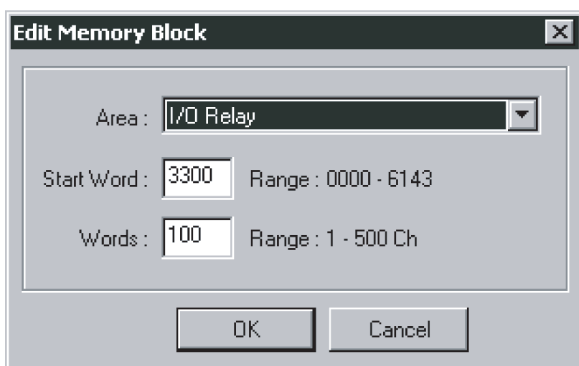

- Set the *Area*, *Start Word*, and *Words*.
For the *Words*, set the number of words displayed by the Network Configurator. The maximum number of words that can be allocated for one block is 500.
The setting ranges are as follows:

PLC model	Memory area	Range
CS Series CJ Series	CIO Area	0000 to 6143
	DM Area	D0000 to D8191
	Work Area	W000 to W511
	Holding Area	H000 to H511
	EM Area	E00000 to E32767

Banks 0 to12 can be used for the EM Area.

- Note**
- (1) The number of words of a block displayed on the Network Configurator is set for *Words*. This value is not downloaded to the master.
 - (2) If the number of allocated words in 1 block is 100 or less, the number of words will be displayed as 100 words when uploading.
- Click the **OK** Button to change the memory block.
If memory has already been allocated to devices, it will be re-allocated in the new memory block. If the area is exceeded, however, the corresponding device allocation will be deleted. Allocate memory again.

I/O Allocation Method

I/O Allocation Tab Pages (*Device - Parameter - Edit*)

There are three ways to allocate I/O.

- Manual Allocation Using the Edit Window
Select a slave device from the Registered Device List and click the Edit Button. Use the Edit Window to manually allocate memory to each slave.
- Allocation Using a Drag-and-drop Operation
Drag a device from the Registered Device List and drop it at the corresponding word location in the memory block that you want to allocate.
- 3) Auto-allocation
Select a device from the Registered Device List and click the Auto Button. This enables auto-allocation for unused words. (A device for which the user setting was performed using the Advanced Setup Button on the General Tab Page, however, cannot be automatically allocated.)

Note An image like the following will be displayed in the *Size* Field of the Registered Device List for the I/O data size of a device for which multiple connections are set on the General Tab Page.

Name	Size	Ch
ProductCode (...)	4, 4 Byte	

To allocate the I/O on the left using a drag-and-drop operation, drag it with the left button on the mouse. To allocate the I/O on the right using a drag-and-drop operation, drag with the right button on the mouse. When there is only one connection, use the left button on the mouse.

Manual Allocation Using the Edit Window

Edit Button on an I/O Allocation Tab Page

Use the following procedure to allocate manually using the Edit Window.

1. Select the device for which you want to edit the I/O allocation.
2. Click the **Edit** Button.
3. The Edit I/O Allocation Dialog Box will be displayed. Examples are shown below. Specify Block 1 or 2, the allocated word, start byte (low byte: *Low*, high byte: *High*), and the number of allocated bytes (*occupied*).

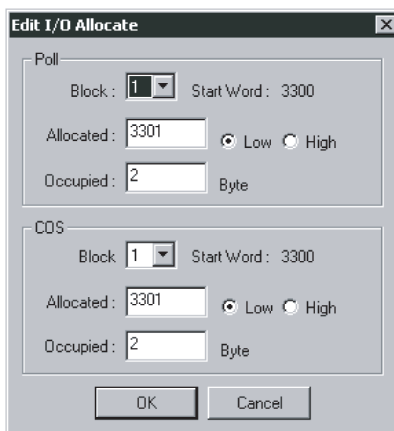
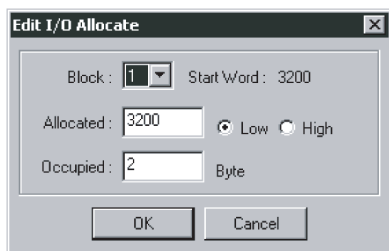

Connections are specified in the General tab with the advanced setup function.

Specify the start word to allocate and the number of allocated bytes.

Byte location (i.e., high/low) can also be specified with the allocated word setting. When the number of allocated bytes is 2 bytes or more, you must specify *Low*.

Allocating One Low Byte to a Device

	15	8	7	0
	High		Low	
+0CH				#00
+1CH				
+2CH				

Allocating One High Byte to a Device

	15	8	7	0
	High		Low	
+0CH	#00			
+1CH				
+2CH				

4. Click the **OK** Button to perform the I/O allocation.

Allocation Using a Drag-and-drop Operation

Drag-and-drop operation on an I/O Allocation Tab Page

1. Display the Memory Block List where you want to allocate memory to the slave.
2. Select the slave from the Registered Device List in the upper pane.
3. Drag it to the start byte you want to allocate to the slave.

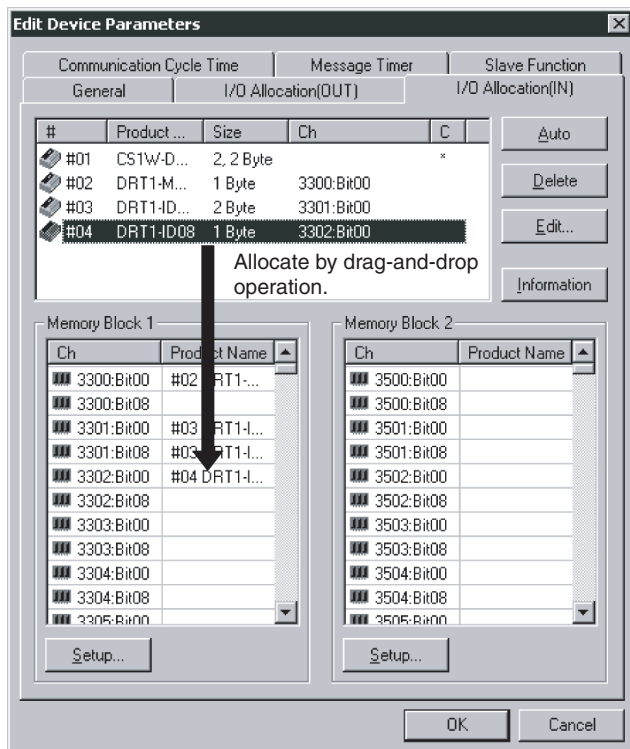

- **Memory Block List Contents**

In the Memory Block Lists at the bottom of the window, the allocated memory (i.e., word address and start bit address) is displayed in the *Ch* column and the product name (i.e., model) of the slave to which the memory is allocated is displayed in the *Product Name* column.

- **Registered Device List Contents**

In the Registered Device List at the top of the window, the node address is displayed in the *#* column, the slave product name (i.e., model) in the *Product Name* column, the number of allocated bytes in the *Size* column, and, when memory is already allocated, the start byte (i.e., word address and start bit address) in the *Ch* column.

When deleting or changing allocations for slaves, select the slave from the Registered Device List and click the **Delete** Button.

Note To automatically allocate the next unused word to a slave, select the slave from the Registered Device List and then click the **Auto** Button.

Auto-allocation

Auto/Delete Button on the I/O Allocation Tab Page

- Click the **Auto** Button to allocate the next unused word for the I/O of the selected slave.
 - Click the **Delete** Button to release the I/O allocation of the selected slave.
- If auto-allocation is specified, however, the Advanced Setup function described later cannot be used.

Displaying Slave Information

Information Button on the I/O Allocation Tab Page

Information, such as I/O comments of registered slave devices, can be accessed on the I/O Allocation Tab Page. (To set I/O comments for the I/O data of the slave devices, select *Edit I/O Comment* from the Device Menu.)

Use the following procedure to display the slave information.

1. Select the device for which you want to display the information.
2. Click the **Slave Information** Button.
3. The following window will be displayed.

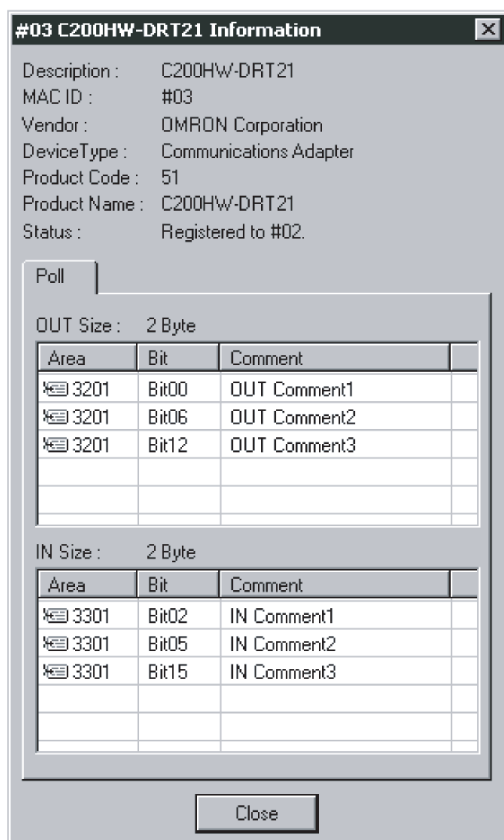

If a registered device is selected while the Information Window is displayed, the slave information will be updated to the information of the selected device.

A-2-5 Advanced Settings: Connection, Communications Cycle Time, Slave Function Settings, etc.

This section describes connection settings, device information and check selection displays, the communications cycle time setting, message timer settings, and slave function settings.

Advanced Setup

Advanced Setup Button after Selecting a Slave on the General Tab Page (*Device - Parameter - Edit*)

Advanced settings, including device information and check selection displays, and connection settings, can be made for remote I/O communications.

Device Information Display and Check Selections

- Device Information Tab Page

It is possible to display device information and to perform checks for the slave devices. Use the following procedure.

1. Select a slave device from the Registered Device List.
2. Click the **Advanced Setup** Button.
3. The following window will be displayed.
Device Information Tab Page

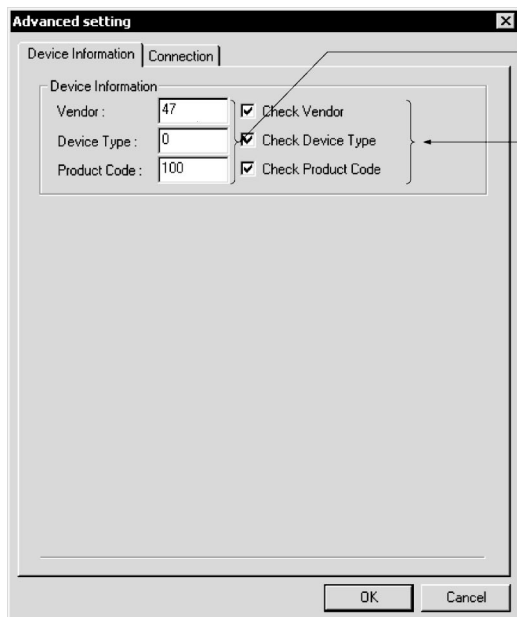

The device information on the selected slave will be displayed.

If these options are selected, the device information will be compared with the corresponding data in the scan list during remote I/O communications. If the information does not coincide with the data, a verify error will occur.

The device information (vendor, device type, product code) of the currently selected slave device will be displayed.

Select these options to check device information (and indicate an error for inconsistencies) in remote I/O communications (i.e., when a connection is opened).

Connection Settings

- Connection Tab Page

The user can specify a maximum of two connections per slave to use in remote I/O communications. Use the following procedure.

1. Select the slave device in the Registered Device List.
2. Click the **Advanced Setup** Button.
3. The following window will be displayed.
Click the **Connection** Tab.

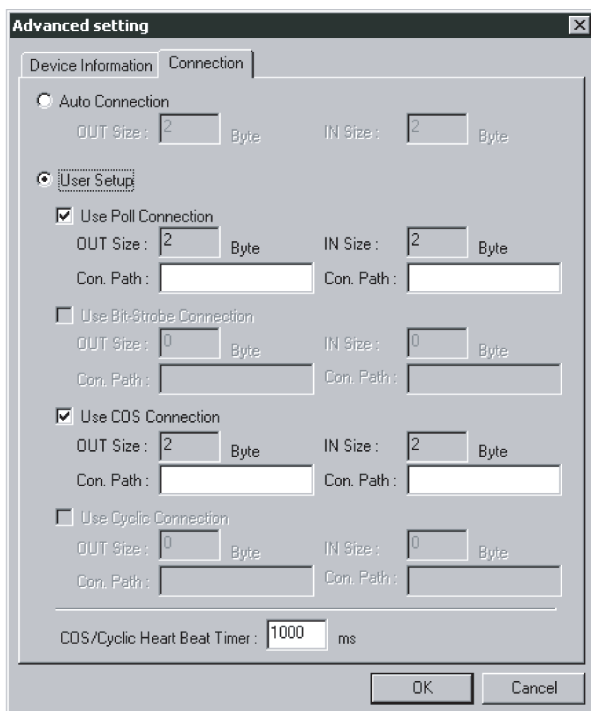

The default setting is *Auto Connection*.

Use the following procedure to specify a connection.

1. Select the *User Setup* Option.
Settings will be enabled for connections.
2. Select the connections to use.
Up to two connections can be set.

Note *COS* and *Cyclic* cannot be set at the same time.

3. Set a connection path if necessary.
4. Set the *COS/Cyclic Heartbeat Timer* value if necessary.
5. Click the **OK** Button.

An asterisk will be displayed in the *C* column at the right in the Registered Device List.

If a connection for a device for which I/O allocation has already been performed is changed, the present I/O allocation will be deleted. Allocate memory again.

IMPORTANT

- *COS* and *Cyclic* cannot be set at the same time.
- If both a poll and *COS* connection or a both poll and cyclic connection are used, the output settings for both connections must be the same.

Note The auto-allocation function cannot be used for a device for which a connection has been set in the Advanced Setup. To enable using the auto-allocation function, unregister the device and then register it again.

Communications Cycle Time Setting

Communications Cycle Time Tab Page (*Device - Parameter - Edit*)

The communications cycle time setting and the communications cycle times calculated based on the currently registered device information can be accessed on the Communications Cycle Time Tab Page.

Click the **Communications Cycle Time** Tab to display the following window.

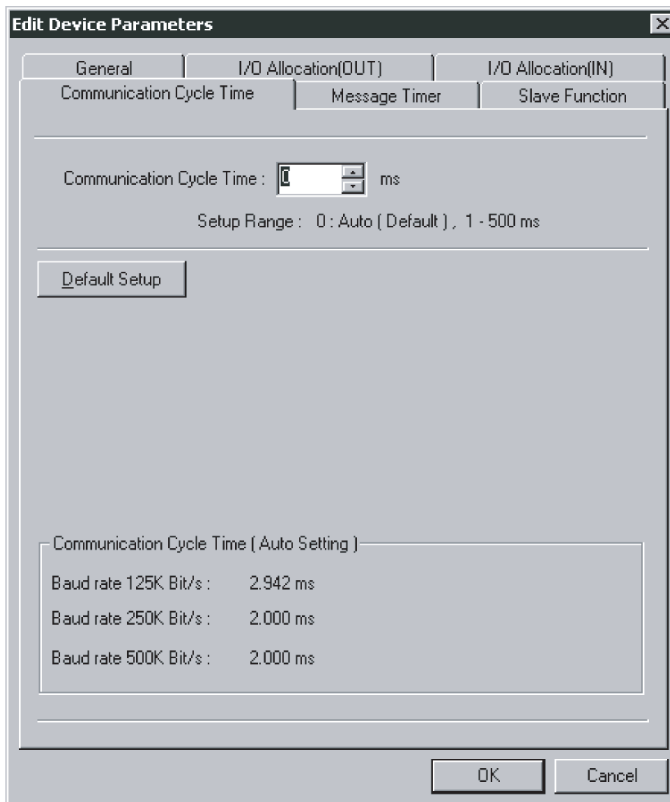

The communications cycle time is set between 1 and 500 ms. Click the Default Setup Button or specify 0 ms to enable automatic setting.

The communications cycle time for the automatic setting is calculated and displayed for each baud rate based on the currently registered device information.

Note The communications cycle time is the interval at which remote I/O communications are performed for the same slave. Setting this time can prevent fluctuations in the communications cycle time based on conditions. Setting a longer communications cycle time can prevent a slave with a slower processing speed from being detected as having an error.

If actual remote I/O communications take shorter than the communications cycle time setting, remote I/O communications will wait for the communications cycle time to expire. If the actual remote I/O communications take longer, the remote I/O communications are performed in the actual time interval regardless of the communications cycle time setting.

Message Timer Settings

Message Timer Tab Page (*Device - Parameter - Edit*)

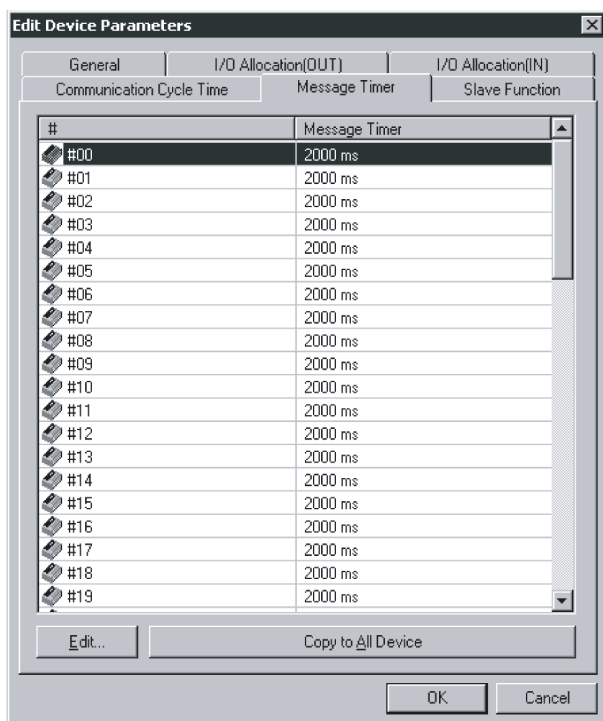

The default value for the message timer is 2 seconds (2,000 ms). Set a value between 500 and 30,000 in increments of milliseconds.

Use the following procedure to change the value.

1. Double-click a node address (#) (or select a node address and click the **Edit** Button) to change the setting. The following dialog box will be displayed.

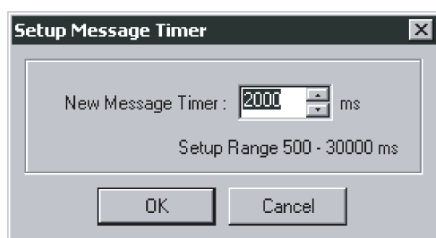

2. Enter a value and click the **OK** Button.

Note To set the same value for all the devices, select the node address value you want to set and click the *Copy to All Device* Button.

- Note**
- (1) The message timer monitors timeouts in message communications (the same timer is used for both explicit message communications and FINS communications messages), and it can be set for each device for which communications are performed (message destinations).
 - (2) If the target communications device (i.e., the message destination) is slow to respond, the message time setting will need to be increased. (The response may take a long time especially when crossing network layers for FINS message communications. Set a longer timer value when crossing network layers.) When a long timer value is set, however, the next message cannot be sent to the same communications device while waiting for a response.
 - (3) The DeviceNet Unit monitors message timeouts by using this timer. In contrast, monitoring using the response monitoring time for CMND, SEND, and RECV instructions is performed by the CPU Unit.

Therefore, there is no effect if the message timer or response monitoring time for CMND, SEND, and RECV instructions is set longer than the other.

- (4) Set the response monitoring timer for CMND, SEND, and RECV instructions to the same or longer than the message timer (Response monitoring time for CMND/SEND/RECV instructions \geq Message timer).

If many timeouts occur, set both values longer while maintaining the relation given above.

Setting as Slave Function

Slave Function Tab Page (*Device - Parameter - Edit*)

The slave function can be enabled by the setting on the Slave Function Tab Page.

IMPORTANT To enable the slave function, select the device and select **Device - Property**. Select the *Enable Slave Function* Option in the CS/CJ-series DeviceNet Unit Properties Dialog Box.

Use the following procedure to set the slave function.

1. Click the **Slave Function** Tab.
2. The following window will be displayed.

3. Specify a connection.
The default setting is *Auto Connection*. Click the *User Setup* Option to set a connection.
4. Set the I/O areas to use for remote I/O communications.
Set the areas, start words, allocated sizes for input (Slave to Master) and output (Master to Slave).
If the *User Setup* Option is selected, set all the connections to be used.
Up to 2 connections can be set.

IMPORTANT

- *COS* and *Cyclic* cannot be set at the same time.
- If both a poll and COS connection or both a poll and cyclic connection are used, the output settings for both connections must be the same.

A-3 Editing Parameters for CS/CJ-series EtherNet/IP Units

This appendix describes how to edit the parameters in a CS/CJ-series EtherNet/IP Unit using the Network Configurator.

A-3-1 Example of Setting Parameters Using a CS/CJ-series EtherNet/IP Unit

Use the following procedure to set parameters for standard communications with an NE1A-series Controller that supports EtherNet/IP.

1. Make the Standard Target settings for NE1A-series Controllers that support EtherNet/IP. For details on making the settings, refer to *5-4 Setting the Controller as an EtherNet/IP Standard Target*.
2. Create and group the tags using a CS/CJ-series EtherNet/IP Unit.

Note With a CS/CJ-series EtherNet/IP Unit, create tag sets that are the same size as the EtherNet/IP target I/O set for the NE1A-series Controller.

3. Set the connections.

Creating Tags and Tag Sets

Creating a Tag Set

Use the following procedure to create tags.

1. Double-click the icon of the device (for which a tag set is being created) to display the Edit Device Parameters Dialog Box. Right-click the icon to display the pop-up menu, and select **Parameter - Edit**.

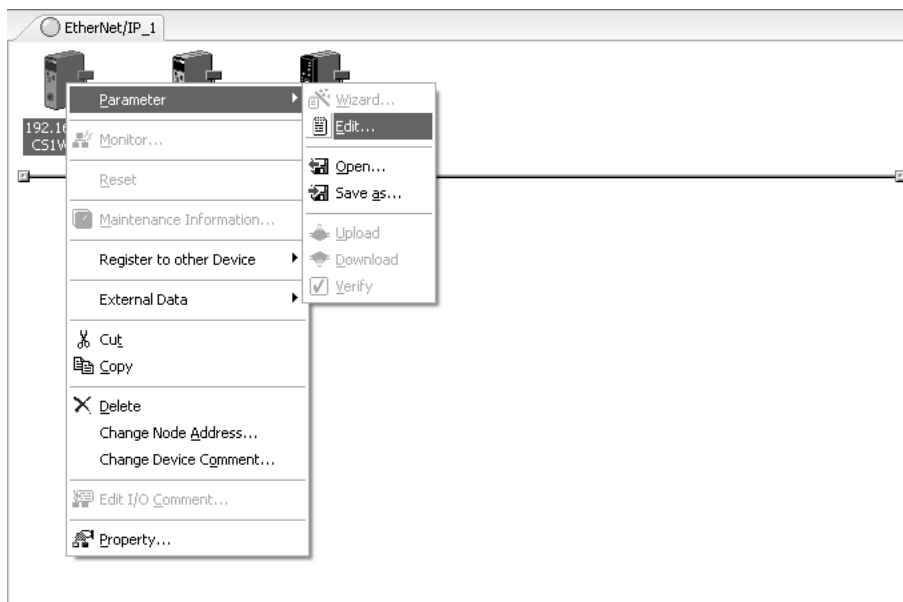

2. Click the **Tag Sets** Tab at the top of the Edit Device Parameters Dialog Box. There are two kinds of tag sets: input (consume) and output (produce).

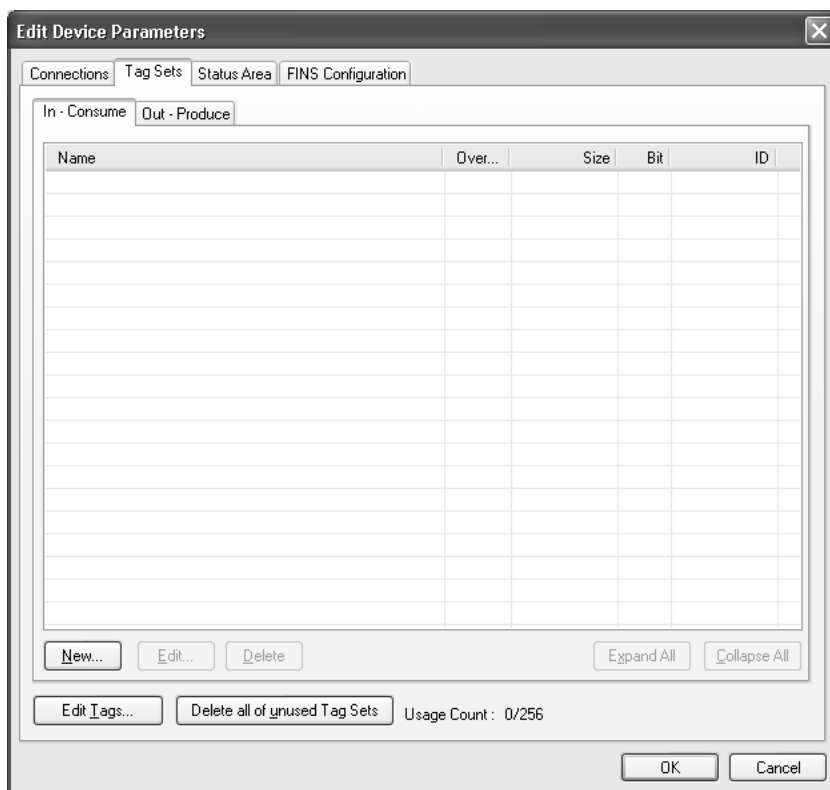

3. Click the **Edit Tags** Button. The Edit Tags Dialog Box will be displayed. Register the input (consume) tags and output (produce) tags separately.

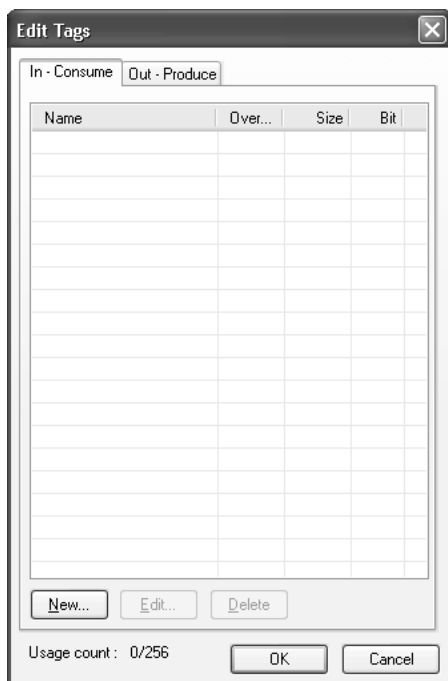

4. Click the **In - Consume** Tab, and click the **New** Button. The Edit Tag Dialog Box will be displayed.

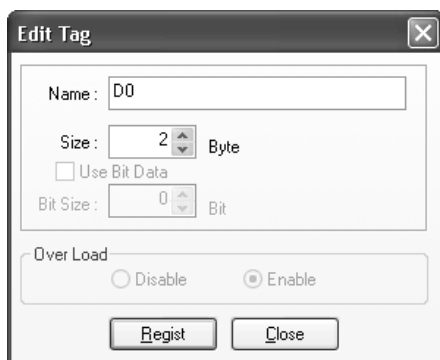

5. In the *Name* Field, input the character string of the CPU Unit's data area address, e.g., 100, W100, or D0. The following data areas can be set.

CPU Unit's data area		Address (Text to input in <i>Name</i> Field.)
CIO Area		0000 to 6143
Holding Area		H000 to H511
Work Area		W000 to W511
DM Area		D00000 to D32767
EM Area	Bank 0	E0_00000 to E0_32767
	⋮	⋮
	Bank C	EC_00000 to EC_32767

Note (1) The H, W, D, and E characters can also be input in lower case as h, w, d, and e.

(2) Be sure to input the data area address (such as 100, W100, or D0) directly as a character string.

6. Input the size of the tag in the *Size* Field, in bytes.
7. Click the **Register** Button to register the tag.
The next consecutive data area address will be automatically input in the Edit Tag Dialog Box's *Name* Field, so that the next tag can be edited. When necessary, change the address and input a data size. When you are finished registering tags, click the **Close** Button.
8. Click the **Out - Produce** Tab, and click the **New** Button. The Edit Tag Dialog Box will be displayed, like the dialog box for input tags, except for the *Over Load* setting. The *Over Load* setting determines whether outputs are cleared or continue their previous status when outputs are turned OFF with the PLC's output inhibit function. Output inhibit settings are not required for input (reception) tag sets.
- Follow the output inhibit function: Enabled (default)
Output data is cleared to 0 when a PLC output inhibit occurs.
 - Do not follow the output inhibit function: Disabled
Output data maintains its previous status even after a PLC output inhibit occurs.

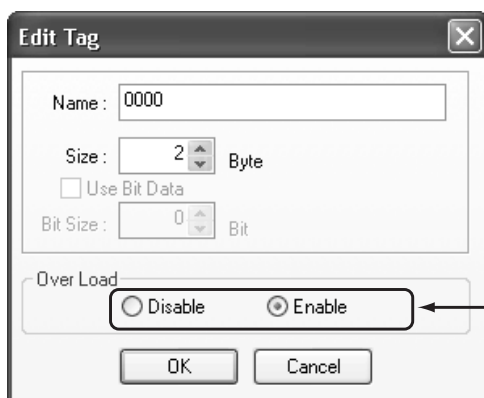

Select Disable or Enable.

Note When any of the following errors occurs in the originator PLC while tag data links are in progress, the connection will be forcibly disconnected.

- Fatal CPU Unit error
 - I/O refreshing error
 - CPU Unit WDT error
 - I/O bus error
9. When you are finished registering the required tags, click the **OK** Button at the bottom of the Edit Tags Dialog Box.

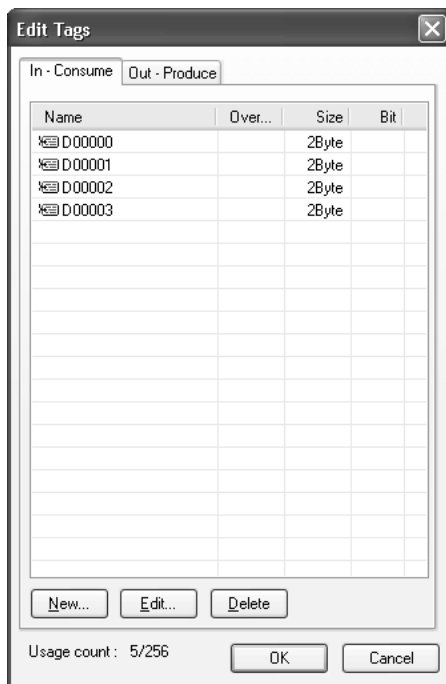

10. At this point, a confirmation dialog box will be displayed to check whether the registered tag names will be registered without changes as tag sets. A tag set can contain up to 8 tags, but tag sets will be registered with one tag per tag set if the tags are registered as tag sets. In this case, the **Yes** Button is clicked to register one tag per tag set.



If the **Yes** Button is clicked, more tags can be registered at the end of the tag set. In this case, only the tags will be registered and they will not be registered in tag sets.

Tag Bit Settings

When bit settings are selected with tags for CS/CJ-series EtherNet/IP Units, they use two bytes of data.

When bit settings are selected with tags for NE1A-series Controllers that support EtherNet/IP Unit, they use 1 byte of data.

When two consecutive tags are set for bits in a pair of devices, memory will be allocated as follows and a connection cannot be established.

NE1A-series Controller Supporting EtherNet/IP

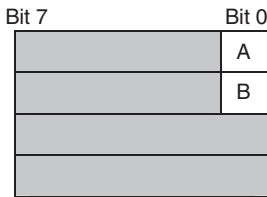

CS/CJ-series EtherNet/IP Unit

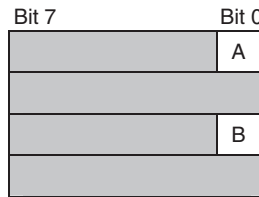

In this case, set the tags for the CS/CJ-series EtherNet/IP Unit for two bytes, so that they can be used in the PLC program.

NE1A-series Controller Supporting EtherNet/IP

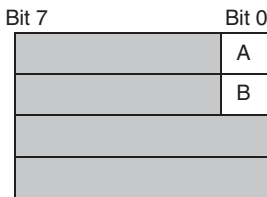

CS/CJ-series EtherNet/IP Unit

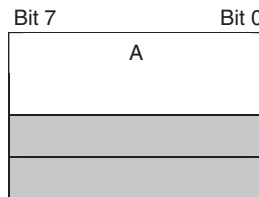

Editing Tag Sets

A tag set is a combination of tags that were previously created. EtherNet/IP target devices use these tag sets to establish connections.

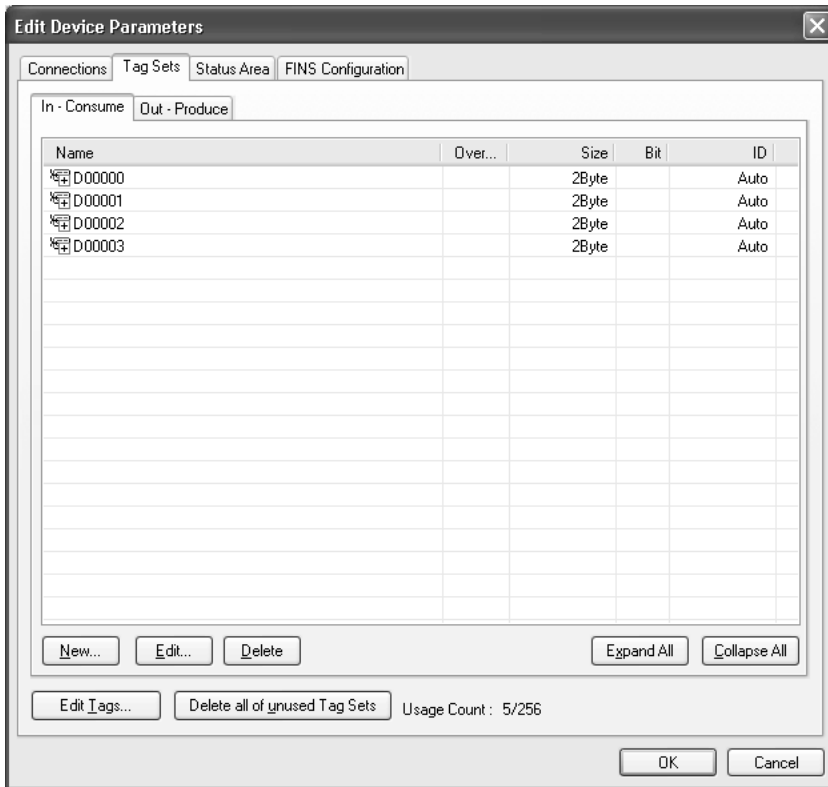

IMPORTANT A tag set must be the same size as the tag set for the device for which the connection is set.

Adding Tag Sets

In order to edit a registered tag set and add tags, either double-click the tag set, or select the tag set and click the **Edit** Button. The Edit Tag Set Dialog Box will be displayed.

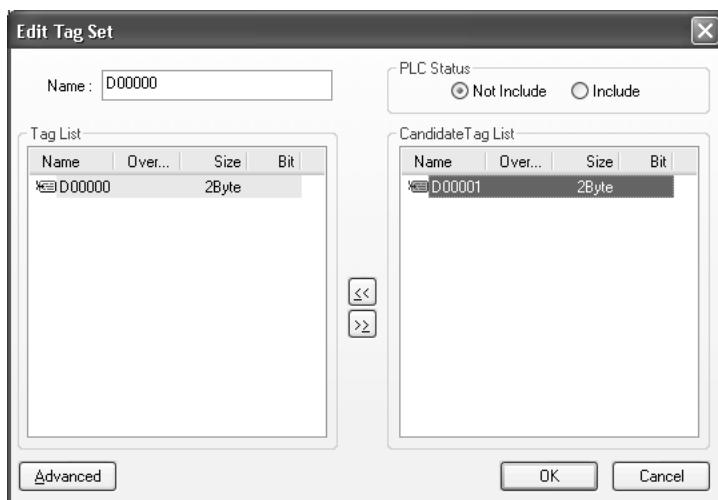

The *Tag List* on the left side of the dialog box shows the tags that are already registered, and the *Candidate Tag List* on the right side of the dialog box shows the other tags that have not been registered yet. To add a tag, select it in the *Candidate Tag List* and click the << Button.

When the PLC status is being included in the tag set, select the *Include* Option at the upper-right corner of the dialog box.

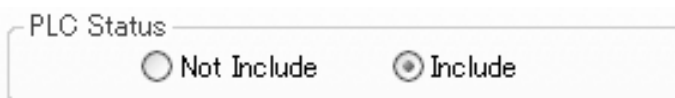

Note When using EtherNet/IP target I/O with an NE1A-series Controller, specify not including PLC status.

Connection Settings

After creating the tag sets, click the **Connections** Tab at the top of the Edit Device Parameters Dialog Box, and set the following connection information.

- The target devices with which connections will be opened
- Whether the tag sets are input or output tag sets
- The length of the packet intervals (RPI)

Make the Connections settings in the originator only. The Connections settings are not necessary in the target device.

Note Make the Connections settings after creating tag sets for all of the devices involved in tag data links.

Registering Devices in the Register Device List

1. Display the originator device's Edit Device Parameters Dialog Box by double-clicking the device's icon in the Network Configuration Window, or right-clicking the device's icon and selecting **Parameter - Edit** from the pop-up menu.
2. Click the **Connections** Tab at the top of the Edit Device Parameters Dialog Box. All of the devices registered in the network (except the local node) will be displayed.

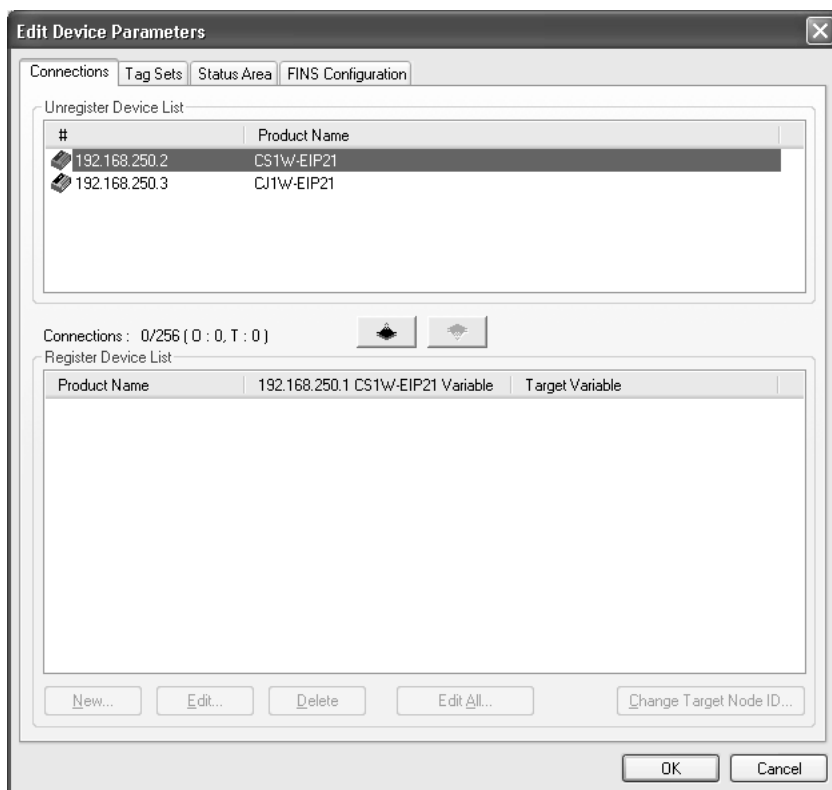

- In the Unregister Device List, select the target device that requires connection settings by clicking the device so its color changes to gray, and click the  Button. The selected target device will be displayed in the Register Device List, as shown in the following diagram.

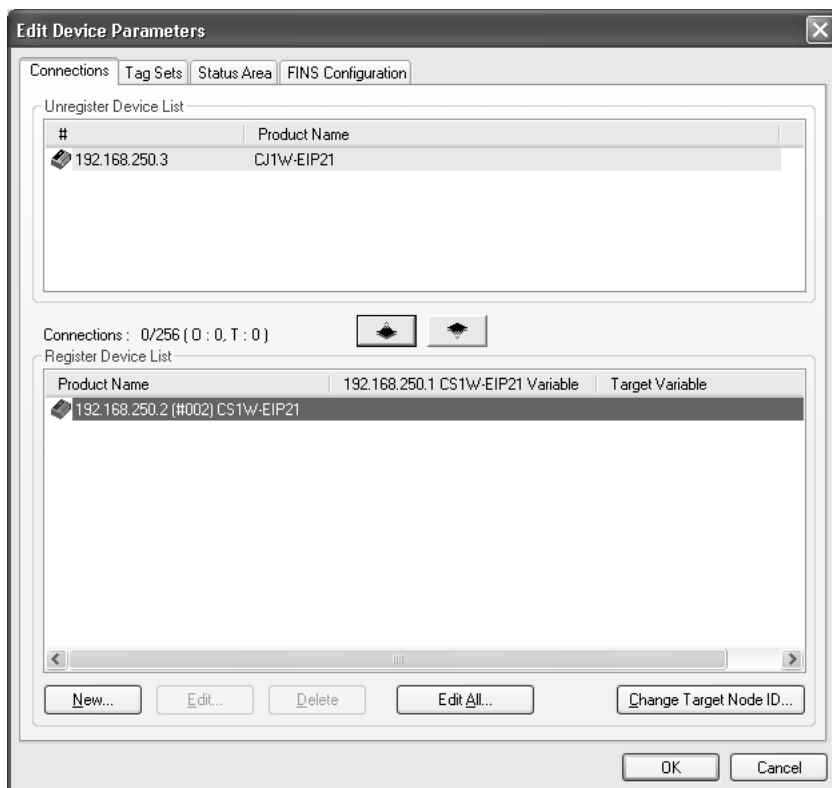

- Target node IDs are assigned to devices registered in the Register Device List. This target node ID determines the location in the originator node PLC of the Target Node PLC Operating Flag, Target Node PLC Error Flag, Registered Target Node Flag, and Normal Target Node Flag. By default, the target ID is automatically set to the rightmost 8 bits of the IP address. In the example above, the target device's IP address is 192.168.250.2, so the device number is #002. If a target node ID is duplicated and you want to change the device number, click the **Change Target Node ID** Button and change the target ID.

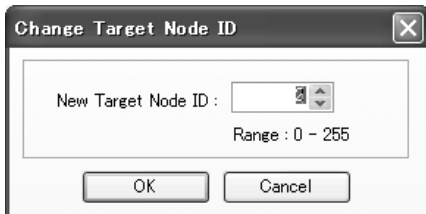

Connections Settings (Editing All Connections)

The connection settings between the originator and all of the target devices selected in the Register Device List can be edited together in a table. (There is another method in which connections are edited individually.)

- Select the **Connections** Tab, and click the **Edit All** Button. The following Edit All Connections Dialog Box will be displayed.

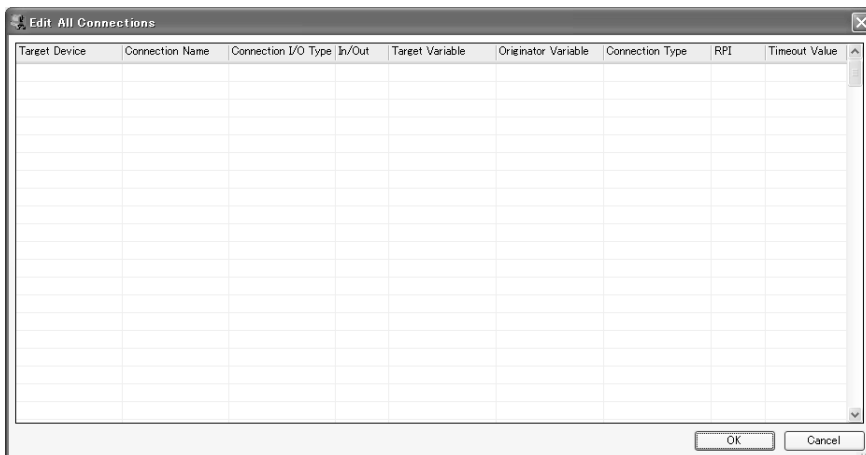

The following table describes the various settings in the dialog box.

Setting	Function
Target Device	Selects the target device.
Connection Name	Any name can be given to the connection (up to 32 characters). If this field is left blank, a default name will be assigned. This Connection Name can be used for comments.
Connection I/O Type	When making tag data links in a CS1W-EIP21 or CJ1W-EIP21, select Input Only (Tag type) . When making tag data links in other devices, select the connection I/O type specified in that device's EDS file. Use the Input Only (ID type) setting when another company's node is the originator and does not support connection settings with the <i>Tag type</i> setting.
In/Out	The connections I/O is automatically displayed based on the selected connection. <ul style="list-style-type: none"> • Input Only: Just <i>In</i> is displayed. • Output Only: Just <i>Out</i> is displayed. • Output & Input: <i>In</i> and <i>Out</i> are displayed in two levels.

Setting	Function
Target Variable	Selects and allocates the target node's tag set. <ul style="list-style-type: none"> • In: Selects the target's output (produce) tag set. • Out: Selects the target's input (consume) tag set.
Originator Variable	Selects and allocates the originator node's tag set. <ul style="list-style-type: none"> • In: Selects the originator's output (produce) tag set. • Out: Selects the originator's input (consume) tag set.
Connection Type	Selects whether the data is sent in a multicast or unicast. The default setting is multicast. <ul style="list-style-type: none"> • Multicast connection: Select when the same data is shared by multiple nodes. This setting is usually selected. • Point-to-Point connection: Select when the same data is not being shared by multiple nodes. In a unicast transmission, other nodes are not burdened with an unnecessary load. <p>Note Refer to 7-1-3 <i>Overview of Operation</i> in the <i>SYSMAC CS and CJ Series EtherNet/IP Units Operation Manual</i> (Cat. No. W465) for details on using multicast and unicast transmissions, and counting the number of connections.</p>
RPI	Sets the packet interval (RPI) of each connection between the originator and target. The interval can be set between 0.5 and 10,000 ms, in 0.5-ms units. The default setting is 50 ms (data refreshed once every 50 ms).
Timeout Value	Sets the time until a connection timeout is detected. The time out value is set as a multiple of the packet interval (RPI) and can be set to a 4, 8, 16, 32, 64, 128, 256, or 512 multiple. The default setting is 4× the packet interval (RPI).

Setting Example

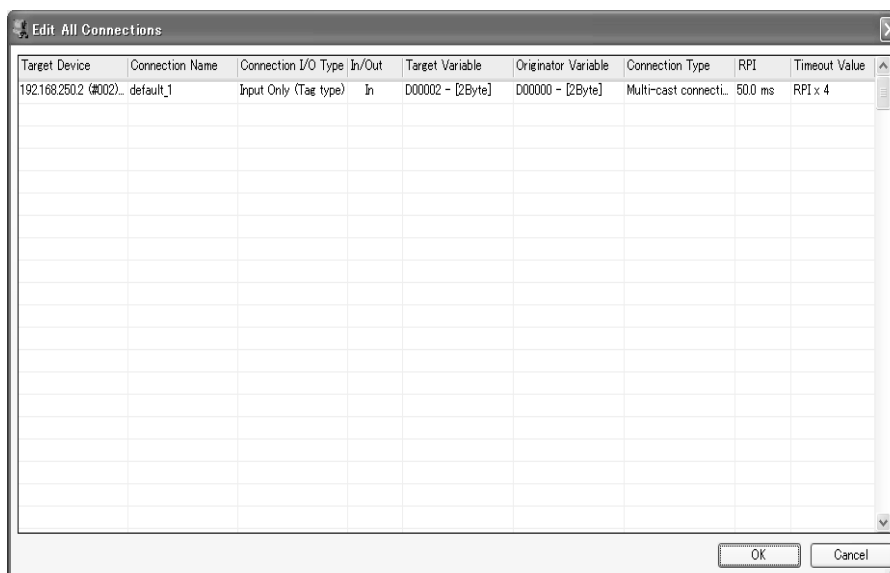

- When the settings are completed, click the **OK** Button.

Connections Settings (Editing Individual Connections)

The connection settings between the originator and target devices are edited individually.

- Select the **Connections** Tab, and click the **New** Button. The following Edit Connection Dialog Box will be displayed.

The following table describes the various settings in the dialog box.

Setting	Function
Connection Name	Assigns a name to each connection.
Connection I/O type	Select one of the following connection I/O types according to the target connection. <ul style="list-style-type: none"> • Input Only (Tag type) • Output Only (Tag type) • Input Output (Tag type)
Connection Type	Selects whether the data is sent in a multicast or unicast. The default setting is multicast. <ul style="list-style-type: none"> • Multicast connection: <ul style="list-style-type: none"> Select when the same data is shared by multiple nodes. This setting is usually selected. • Point-to-Point connection: <ul style="list-style-type: none"> Select when the same data is not being shared by multiple nodes. In a unicast transmission, other nodes are not burdened with an unnecessary load.
Packet Interval (RPI)	Sets the data refreshing interval (packet interval) of each connection between the originator and target. The interval can be set between 0.5 and 10,000 ms, in 0.5-ms units. The default setting is 50 ms (data refreshed once every 50 ms).
Timeout Value	Sets the time until a connection timeout is detected. The time out value is set as a multiple of the packet interval (RPI) and can be set to a 4, 8, 16, 32, 64, 128, 256, or 512 multiple. The default setting is 4× the packet interval (RPI).
Input from Target Device	Allocates the originator's input (consume) tag set selected for the originator variable (Consume Variable) to the target's output (produce) tag set selected for the target variable (Produce Variable).
Output to Target Device	Allocates the originator's output (produce) tag set selected for the originator variable (Produce Variable) to the target's input (consume) tag set selected for the target variable (Consume Variable).

Setting Example

2. After completing the settings, click the **OK** Button.

Confirming the Connections Settings

1. An overview of the connections set in the Register Device List is displayed in the Connections Tab Page.

Product Name	192.168.250.1 CS1W-EIP21 Variable	Target Variable
192.168.250.2 (#002) CS1W-EIP21 TEST [Input]	D00000	D00000

- Click the **OK** Button. The following kind of diagram will be displayed.

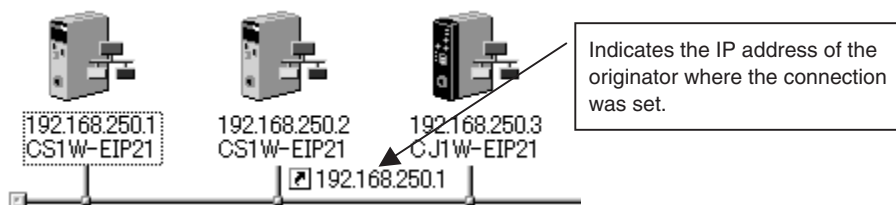

- Repeat the Connections setting procedure until all of the connections have been set.

Note After completing the settings, always click the **OK** Button before closing the Edit Device Parameters Dialog Box and performing another operation. If the **Cancel** Button is clicked and the dialog box is closed, the new settings will be discarded.

- If the tag set's size is changed in either the originator or target after the connection was set, the size will not match the other node and a parameter data mismatch will occur. In this case, if the connection settings have been changed, be sure to check the connections. (Refer to 7-2-13 *Checking Connections* in the *SYSMAC CS and CJ Series EtherNet/IP Units Operation Manual* (Cat. No. W465).)

A-4 EDS File Management

This section describes the managing the EDS file used in the Network Configurator.

Precautions for Safe Use

If you are using Windows Vista or a later version, start the Network Configurator as the administrator to install, create, or delete EDS files, or to create EDS index files with the Network Configurator. User management performed by Windows security will not apply the results of these operations when Network Configurator is started normally for other user accounts (including the administrator).

1. Select the Network Configurator from the Start Menu, and then right-click.
2. Select **Run as administrator** from the pop-up menu that is displayed.

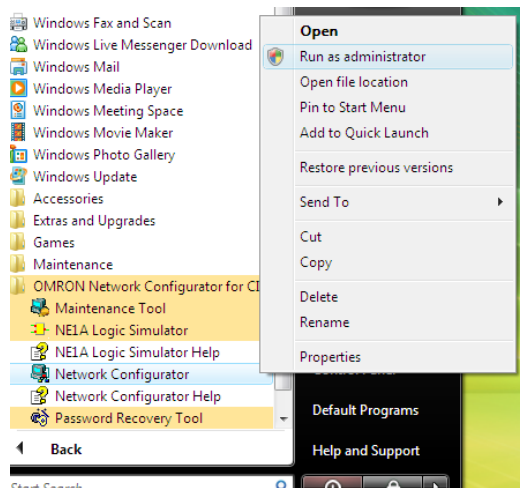

A-4-1 Installing EDS Files

EDS File - Install

Installing an EDS file enables the Network Configurator to support a new device type. Use the following procedure to install an EDS file.

1. Select **EDS File - Install**.
The following window will be displayed.

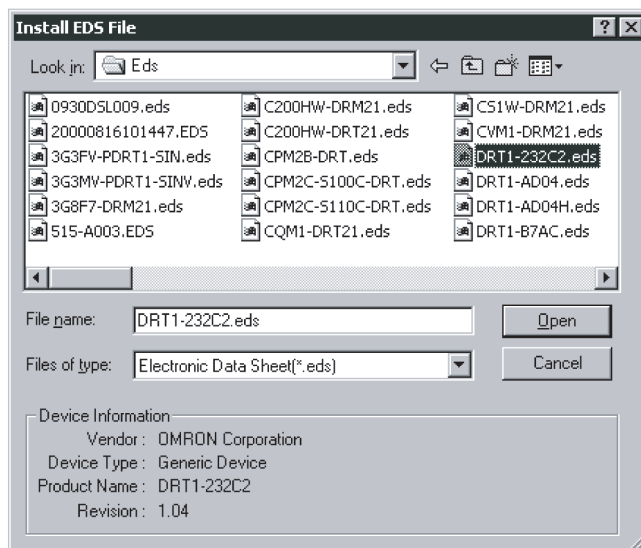

2. Select the EDS file to install. The device information will be displayed in the lower part of the window.

- Click the **Open** Button.

The file will be added to the Hardware List Window as new hardware.

If the same hardware already exists, it will be updated to the latest version.

If the hardware version is different, it will be added to the Hardware List in the following way.

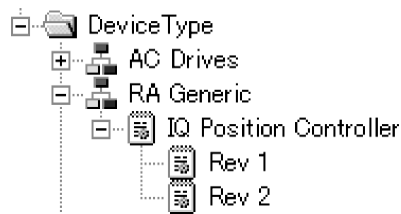

A-4-2 Creating EDS Files

EDS File - Create

An EDS file is absolutely essential to create a network configuration using the Network Configurator. Use the following procedure to create an EDS file.

- Select **EDS File - Create**.

The following window will be displayed.

Create EDS File

Device Information:

Vendor ID : 47 Vendor Name :

Device ID : 12 Device Type :

Product Code : 51 Product Name : C200HW-DRT21

Major Rev. : 1 Catalog :

Minor Rev. : 3

Default I/O:

Poll Bit-Strobe COS Cyclic

Poll Bit-Strobe COS Cyclic

OUT:

Size : 64 Byte

Valid Bits : 0 (0:Valid all Bits)

Name : OUT Data

Path :

Help :

IN:

Size : 64 Byte

Valid Bits : 0 (0:Valid all Bits)

Name : IN Data

Path :

Help :

- Set the device information and I/O information.

The device information can be obtained from a device in the network when it is online.

- Click the **Obtain from Device** Button. The following window will be displayed.

Target Device

Target Node Address : 0

Setup Range 0 - 63

4. Set the node address for a target device and click the **OK** Button.
Refer to the relevant device manual and set an I/O connection and an I/O size that the device supports.
5. Click the **OK** Button.
The file will be added to the Hardware List Window as a new device in the same way as in the EDS file installation.

Note The device parameter settings cannot be created using the EDS file creation function of the Network Configurator. To set device parameters, obtain the EDS file from the device manufacturer.

A-4-3 Deleting EDS Files

EDS File - Delete

Use the following procedure to delete an EDS file.

1. Select the hardware (i.e., device) in the Hardware List Window.
2. Select **EDS File - Delete**.
A confirmation window will be displayed. An example is shown below.

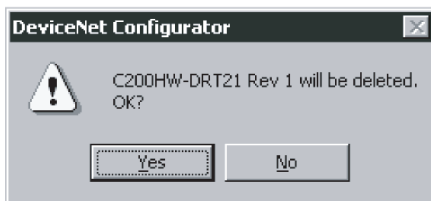

3. Click the **Yes** Button.
The EDS file and the target device will be deleted from the Hardware List Window.

A-4-4 Saving EDS Files

EDS File - Save

Use the following procedure to save an EDS file.

1. Select the hardware (i.e., device) in the Hardware List Window.
2. Select **EDS File - Save**.
A window for specifying the folder and file name for saving the EDS file will be displayed. An example is shown below.

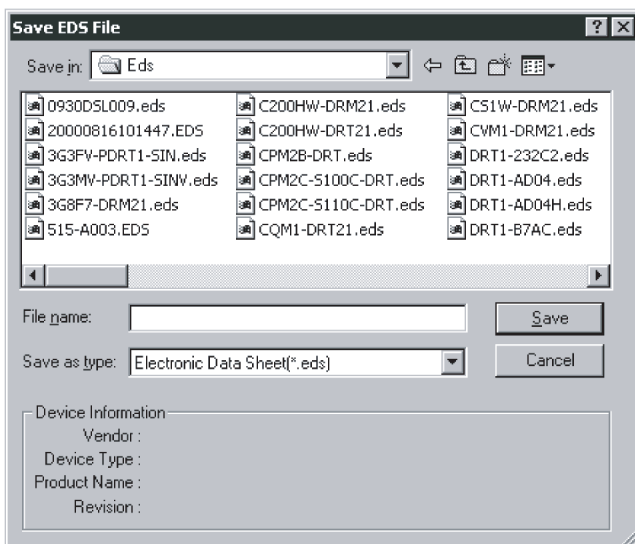

- Specify a folder and file name and click the **Save** Button.
The EDS will be saved.

A-4-5 Searching EDS Files

EDS File - Find

Use the following procedure to search for a device (i.e., EDS file) displayed in the Hardware List Window.

- Select **EDS File - Find**.
The following window will be displayed.



- Set the character string to search for and click the **Find Next** Button.
- The cursor will move to the device if there is a matching device.
- Click the **Cancel** Button to exit the search.

Note (1) The search will be made for devices below the present cursor position in the Hardware List Window.
(2) To search all the devices, select **Hardware** in the Hardware List Window and then perform the search.

A-4-6 EDS File Properties

EDS File - Property

Use the following procedure to display the properties of an EDS file.

- Select the hardware (i.e., device) in the Hardware List Window.
- Select **EDS File - Property**.
The following window will be displayed.

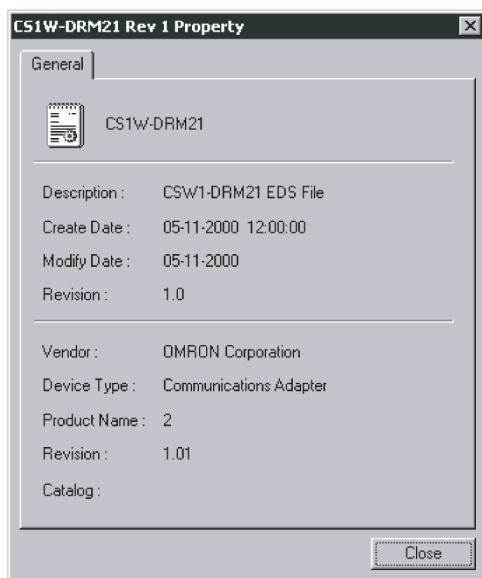

The date and time the EDS file was created and device information will be displayed.

A-4-7 Recreating EDS Files

EDS Files – Create EDS Index File

If the devices are not correctly displayed in the Hardware List Pane, use the following procedure to recreate the EDS index file.

(Network Configurator version 3.30 or higher)

1. Select ***EDS Files – Create EDS Index File***.
2. Restart the Network Configurator.

A-5 Using General-purpose Tools to Set Devices

This section describes how to set parameters that are not written in an EDS file and how to set node addresses and baud rates through the network.

A-5-1 Setting Device Parameters by Specifying Class and Instance

Tool - General Parameter

The following items can be set to enable setting device parameters that are not written in an EDS file.

- Service Code
- Class (object class), instance (class instance), attribute (instance attribute)

To set parameters other than these codes, the configuration information for the data setting for the attributes must be obtained from the device manufacturer. If there is any unknown information, the parameters cannot be set.

Use the following procedure to set device parameters.

1. Connect the Network Configurator online.
2. Select ***Tool - General Parameter***.

The following window will be displayed.

3. Set the node address of the device for which parameters are being set in the *Target Node Address* Field.

4. Specify a service.

A service code can be specified by using a common service code defined in the DeviceNet or by directly specifying a service code. To specify a common service code defined in the DeviceNet, select a service from the drop-down list.

To specify a service code directly, select the *Custom Service* Option in the *Service* Field and directly enter a service code in hexadecimal.

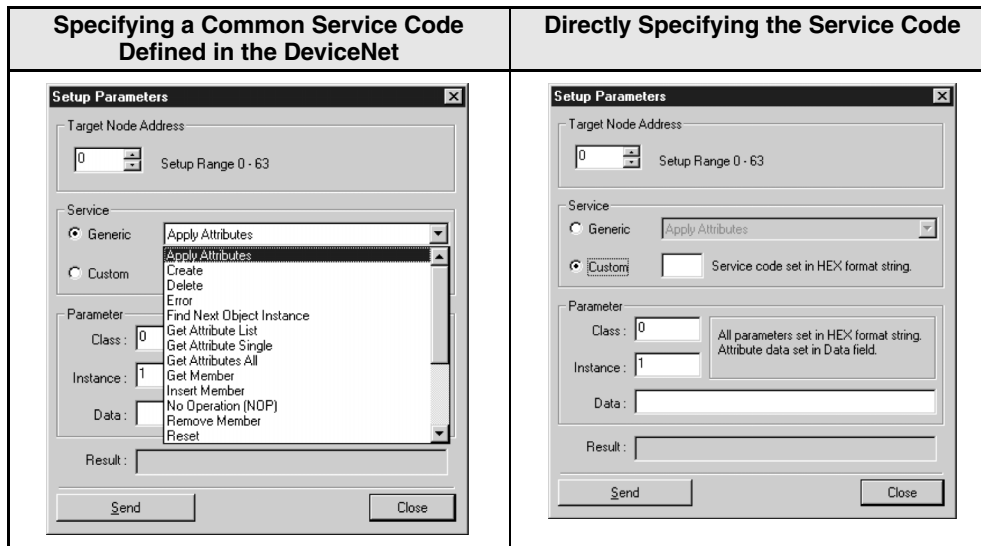

5. Specify the class and instance of the parameters for which the settings are to be read or written.
6. Enter the data based on the specified service type.
7. Enter all the items and click the **Send** Button. The response from the device will be displayed in the *Result* Field.
8. Click the **Close** Button to exit the Device Parameter Setting Window. The Device Parameter Setting Window will close.

Example 1: Reading Parameters

1. Select the *Standard* Option in the *Service* Field and select *Get Attribute Single* from the drop-down list.
2. Specify the class and instance of the parameter to read.
3. Enter the attribute of the parameter to read in the *Data* Field.
4. Click the **Send** Button. The read value will be displayed in the *Result* Field.

Example 2: Setting Parameters

1. Select the *Standard* Option in the *Service* Field and select *Set Attribute Single* from the drop-down list.
2. Specify the class and instance of the parameter to set.
3. Enter the attribute of the parameter to set in the *Data* Field.
4. Set the value in the *Parameter* Area after the attribute in the *Data* Field.
5. Click the **Send** Button.

A-5-2 Setting the Node Addresses and Baud Rates via the Network

Tool - Node Address/Baud Rate Setting

Use the following procedure to set a device node address and baud rate via the network.

1. Leave only the target device and the Network Configurator operating in the DeviceNet network. Refer to the manual of the device used for the device node address and baud rate in the default settings. Also connect the Network Configurator using the same baud rate.
2. Connect the Network Configurator online.
3. Select ***Tool - Node Address/Baud Rate Setting***.
The following window will be displayed.

The screenshot shows a dialog box titled "Setup Node Address/Baud rate". It contains three main sections:

- Target Node Address:** A spinner control is set to 0, with the text "Setup Range 0 - 63" to its right.
- Change Node Address:** A label "New Node Address:" is followed by a spinner control set to 0 and the text "Setup Range 0 - 63". A "Change" button is located to the right of the spinner.
- Change Baud rate:** A label "Current Setup:" is followed by "---". Below it, a label "New Setup:" is followed by a dropdown menu showing "125K Bit/s" and a "Change" button to its right.

A "Close" button is located at the bottom right of the dialog box.

4. Specify the present node address of the target device in the *Target Node Address* Field.
5. To change the node address, specify a new node address in the *New Node Address* Field and click the **Change** Button.
The node address of the target device will be changed.
6. To change the baud rate, select the rate in the *New Baud Rate* Field and click the **Change** Button.
The baud rate of the target device will be changed.

Note The node address and baud rate can be set via the network only for devices that support this function.

A-5-3 Setting TCP/IP Over a Network

Tools - TCP/IP Setting

Use the following procedure to set TCP/IP for an EtherNet/IP network.

1. In the EtherNet/IP network, have only the target device and the Network Configurator operating. For the default IP address for a device that is to be used, refer to the operation manual for that device.
2. Connect the Network Configurator online.
3. Select **Tools - TCP/IP Setting**. The following window will be displayed.

The screenshot shows a window titled "Setup TCP/IP Configuration". It contains the following fields and controls:

- Target IP Address:** A text box containing "192 168 250 250".
- New Configuration - TCP/IP Configuration:**
 - Radio buttons: Get the IP address via BOOTP server, Not use DNS, Use DNS.
 - Use the following IP address:**
 - IP Address: 192 168 250 1
 - Subnet Mask: 255 255 255 0
 - Default Gateway: 0 0 0 0
 - Use DNS:**
 - Primary DNS: 0 0 0 0
 - Secondary DNS: 0 0 0 0
 - Domain Name: (empty text box)
- Speed & Duplex:**
 - Speed & Duplex: Auto (dropdown menu)
- Buttons: "Set to the Device" (two instances), "Reset the Device", "Get from the Device", and "Close".

4. Specify the present IP address for the target device in the Set IP Address field.
5. Make the required settings and then click the **Set to the Device** Button.
6. The data that has been set will become valid when the power is turned ON again.

A-6 Using the Password Recovery Tool

If the password set for a device is lost, use the Password Recovery Tool to reset the password and to return to the state without any password setting (default settings).

Use the following procedure to reset a device password.

1. Prepare the computer for connecting to the DeviceNet via a USB port or DeviceNet Interface Card.
2. Select **Program - OMRON Network Configurator for DeviceNet Safety - Password Recovery Tool** (when using the default program folder names) from the Start Menu. The Password Recovery Tool will start, and the following Main Window will be displayed.

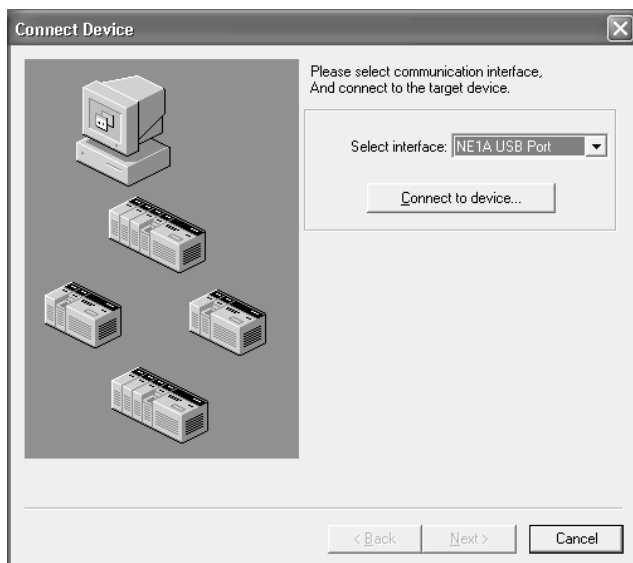

3. Select an interface for connecting to the network and click the **Connect to Device** Button. Click the **Refresh** Button when the window to search for the destination device is displayed.

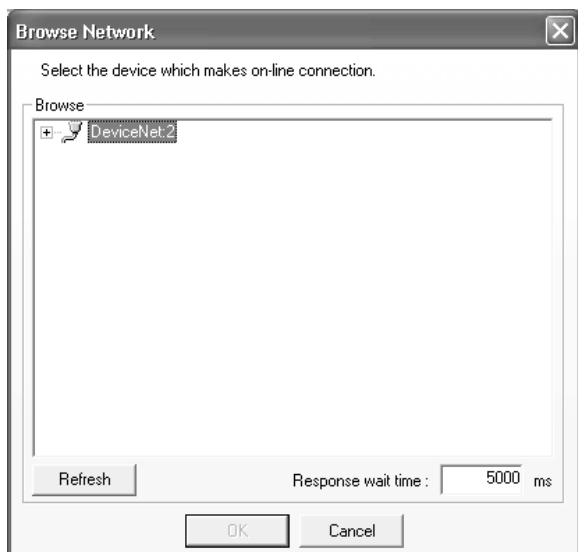

- Set the node address range to search for and click the **OK** Button.

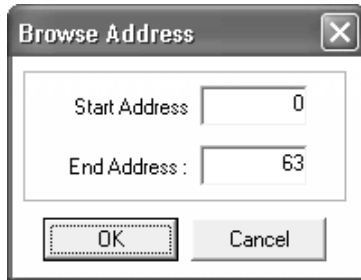

- The devices in the network will be displayed. Select a device for which to reset the password and click the **OK** Button.

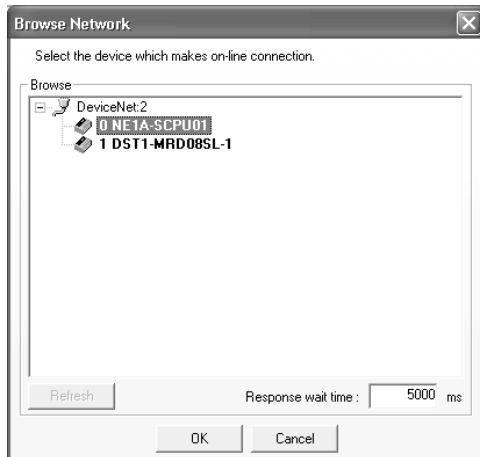

- The necessary information for resetting the password will be displayed. The information is required when inquiring from the Support Center. Print the information by outputting to a text file and or copying to another application using the clipboard.

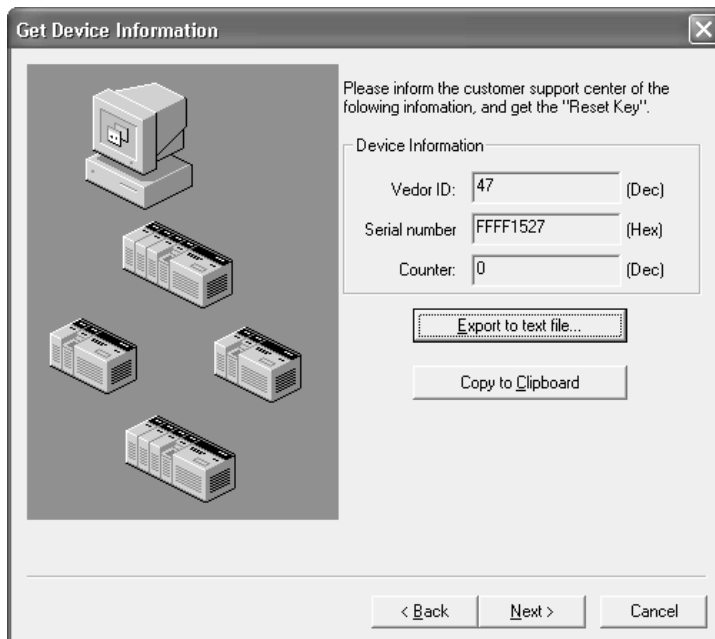

- Click the **Next** Button to display the Reset Key Enter Window. Enter the Reset Key obtained from the Support Center and click the **Reset** Button.

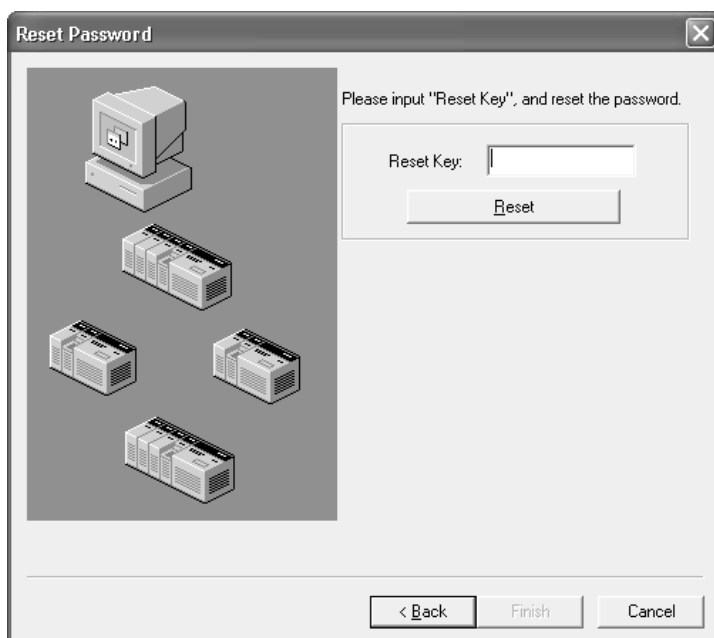

- If the password is successfully reset, the following dialog box will be displayed. The device will be returned to the state without any password setting (default setting). Click the **OK** Button to close the dialog box. Click the **Finish** Button In the Password Recovery Tool Window to exit.



A-7 Restrictions in Support Software Operations for the CPU Unit with EtherNet/IP

The following operations cannot be performed in the EtherNet/IP Network Window with the NE1A-SCPU01-EIP or NE1A-SCPU02-EIP.

Menu	Submenu/Command	
Network	Download	
	Upload	
Device	Parameter	Download
		Upload
		Verify
		Lock/Unlock
	Change password	
	Reset	
	Change mode	

Perform these operations in the DeviceNet Network Window.



DeviceNet Network

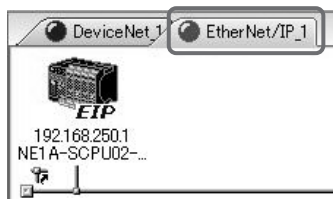

EtherNet/IP Network

Glossary

Term	Definition
assembly	Internal data in a device gathered as one group to be accessed externally.
Busoff	Status that occurs when the error rate is extremely high over a communications cable. An error is detected when the internal error counter exceeds a certain threshold value. (The internal error counter is cleared when the Master is started or restarted.)
configuration	The settings for a device and a network.
connection	A logical communications path used to communicate between devices.
DeviceNet Safety	A safety network that adds a safety protocol to DeviceNet to comply with up to SIL3 according to IEC61508, up to Safety Category 4 according to EN954-1.
discrepancy time	The time period from a change in one of two inputs until the other input changes.
dual channel	Using two inputs or outputs as the input or output for redundancy.
Dual Channel Complementary	Setting to evaluate that two logic states are complementary.
Dual Channel Equivalent	Setting to evaluate that two logic states are equivalent.
EPI	The interval of safety data communications between the Safety Master and the Safety Slave.
error latch time	The time period to hold an error state (control data, status data, and LED indications).
multi-cast connection	Safety I/O communications in a 1:n configuration (n = 1 top 15).
open type	The open method for Safety Connection. One of three types is selected in the settings of a connection to the Safety Master.
safety chain	The logical chain to actualize a safety function, that consists of the input device (sensor), the control device (including a remote I/O device), and the output device (actuator).
safety controller (safety PLC)	A controller with high reliability used for the safety control.
safety data	Data with high reliability.
safety protocol	The communications hierarchy added to actualize highly reliable communications.
safety signature	A certificate of the configuration data issued to a device from the Network Configurator. The device verifies that the configuration data is correct by using the safety signature.
single channel	Using only one input or output as the input or output.
single-cast connection	Safety I/O communications in 1:1 configuration.
Standard	A device or device function to which safety measures are not applied.
test pulse	A signal used to detect external wiring coming into contact with the power supply (positive) or short circuits between signal lines.
TUNID	An identifier to specify one device in all the network domains. Values combining the network address and the node address are used.
output connection owner	The Safety Slave stores the TUNID of the Safety Master that established connections as the output connection owner to prevent unintended safety outputs from a Safety Master. The stored TUNID is held until the Safety Slave is reset to default settings.
configuration owner	The Safety Slave stores configuration owner data to prevent unintended configuration from a remote device. If the Safety Slave was configured by Support Software such as the Network Configurator, it stores the configuration owner was Support Software. If the Safety Slave was configured by a Safety Master, it stores the Safety Master TUNID. the stored data is held until the Safety Slave is reset to default settings.
EtherNet/IP	EtherNet/IP is a network that supports CIP using TCP/IP technology. It can coexist with other TCP/IP-based protocols, and it enables large-capacity and high-speed communications.
CPU Unit without EtherNet/IP	A CPU Unit with one of the following model numbers: NE1A-SCPU01(-V1) or NE1A-SCPU02.

Glossary

Term	Definition
CPU Unit with EtherNet/IP (Unit supporting EtherNet/IP)	A CPU Unit with one of the following model numbers: NE1A-SCPU01-EIP or NE1A-SCPU02-EIP
Standard CPU Unit	A CPU Unit used for standard control, such as CPU Units in OMRON's CS or CJ Series. This term is used to differentiate from Safety CPU Units.

Index

A

acceptable bandwidth, 14, 21
adding a page, 189
adding devices, 71
allocating network bandwidth usage rates and calculating best EPI, 23
allocation by word, 310
allocation minimizing the number of allocated words, 310
AND, 180
Automatic Execution Mode, 165

B

batch exporting, 204

C

calculating the maximum reaction time, 32
changing device status, 100
channel mode, 160, 164
checking, 203
checking the version, 50
clearing the error history, 225, 226
configuration lock, 96
confirming the cycle time, 165
connecting to the DeviceNet network, 293
connecting to the network, 62, 293
connection status, 221
connection type, 137
connections, 186
Connections settings (Edit All Connections), 331
Connections Settings (editing individual connections), 332
contact operations alarm threshold, 231
Copy Group Button, 109
creating a new virtual network, 68
creating EDS files, 337
creating tag sets, 323
cycle time, 23, 161, 165

D

deleting a page, 189
deleting devices, 76
deleting EDS files, 338

device parameters, 84
 editing, 323
device password, 82
device password protection, 82
device properties, 84
device status, 221
DeviceNet Interface Card, 166
DeviceNet Safety Communications, 4
DeviceNet Safety Master, 3
DeviceNet Safety Slave, 3
DeviceNet Standard Master, 3
DeviceNet Standard Slave, 3
discrepancy time, 159
downloading, 85
downloading device parameters, 85
dual channel safety input status, 223
Dual Channel Safety Output Mode, 164
dual channel setting, 164

E

Edit All Connection Window, 142
editing CS/CJ-series DeviceNet Unit parameters, 304
editing function block parameters, 191
editing parameters, 104
EDM, 181
EDS file management, 336
Emergency Stop Switch Monitoring, 181
enabling master function, 304
enabling slave function, 304
EPI, 137
error device list, 88
error latch time, 159, 162, 164
E-STOP, 181
example of EPI calculations, 27
exclusive NOR, 180
Exclusive OR, 180
EXNOR, 180
EXOR, 180
exporting, 204
External Device Monitoring, 181

F

finding function blocks with open connections, 196

function block I/O information, 191
function block placement, 184
function blocks, 180, 183, 196

G

general parameter group, 110
general precautions, xvi
Get from the actual network Button, 70

H

hardware list, 51

I

I/O assemblies, 143
I/O comments, 55, 112
I/O connections, 135
I/O refresh cycle, 166
I/O refresh time, 33
I/O tag, 145, 152
I/O tags, 164
I/O type, 144, 151
importing, 199
input I/O tag placement, 184

J

jump addresses, 190

L

Light Curtain Monitoring, 180
local I/O settings, 156
local safety I/O, 4
Logic Editor, 174
logic functions, 180

M

master parameter overview, 304
menu commands, 176
Message Pane, 51
Monitor Device Button, 218

monitoring, 213
monitoring functions, 218
monitoring parameters, 222
monitoring safety connections, 220
monitoring status, 218
monitoring the error status, 224
monitoring the program, 213

N

network bandwidth, 21
network configuration file, 80
Network Configuration Pane, 51
Network Configurator, 49
network numbers, 68
node address, 76
node address/baud rate settings, 343
NOT, 180

O

OFF delay, 161
Off-Delay Timer, 180
ON delay, 161
On-Delay Timer, 180
online monitoring, 213
open type, 136
operation time, 115
operation time parameter groups, 115
OR, 180
output tag placement, 185

P

page title, 189
parameter verification, 92
password protection for user-defined function blocks, 210
password protection of network configuration file, 79
password recovery tool, 345
precautions for safe use, xix
printing programs, 215
programming, 179
programming restrictions, 179
project file, 203
protect mode, 81

R

- reaction time, 32
- reading the network configuration file, 79
- Register Device List, 329
- registering devices, 329
- registering safety slaves, 132
- Reset, 181
- reset type, 98
- resetting devices, 99
- Restart, 181
- reusing user-defined function block files, 203
- routing, 180

S

- safety configuration, 2
- safety connection settings, 132
- Safety Gate Monitoring, 180
- safety I/O points, 4
- safety input, 111
- Safety Input Channel Mode, 160
- safety input parameter groups, 111
- safety input terminal status, 223
- Safety Logic Controller, 3
- Safety Output Channel Mode, 164
- safety output parameter groups, 114
- safety output terminal status, 223
- safety outputs, 114
- safety precautions, xviii
- safety slave settings, 143
- saving EDS files, 338
- saving the error history, 225, 226
- saving the program, 211
- searching EDS files, 339
- sending explicit messages, 195
- serial communications port, 293
- setting assembly data, 151
- setting connection parameters, 142
- setting general parameters, 341
- setting output points, 193
- setting remote I/O allocations, 309
- setting safety connection parameters, 135
- setting safety inputs, 159
- setting safety outputs, 163

- setting slave input data in idle state, 151
- setting test outputs, 162
- setting the node addresses and baud rates via the network, 343, 344
- setting the operating mode, 165
- setting unit functions, 304
- Slave I/O, 150
- specifying the connection interface, 294
- standard configuration, 2
- standard slave settings, 150
- status, 147, 152
- status change, 98
- SYSMAC CS/CJ Ethernet Unit I/F, 294
- SYSMAC CS/CJ I/F Port, 294

T

- tag sets
 - creating, 323
- Test Output Channel Mode, 163
- test output parameter groups, 113
- test output terminal status, 223
- test outputs, 113
- test source, 161
- total ON time alarm threshold, 229
- trigger address, 195
- TUNID, 68
- Two Hand Controller, 180

U

- unlocking the device configuration, 97
- Unregister Device List, 330
- uploading, 84
- uploading device parameters, 84
- uploading the network configuration, 72
- USB port, 62
- User Mode Switch Monitoring, 181
- user-defined function block files, 205
- user-defined function blocks, 197

W

- workspace, 179

Revision History

The manual revision is indicated at the end of the Cat. No. printed at the lower left of back cover of the manual.

Cat. No. Z905-E1-10

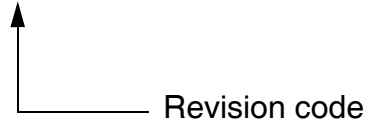

The following table outlines the changes made to the manual during each revision. Page numbers refer to the previous version.

Revision code	Date	Revised content
01	May 2005	Original production
02	April 2006	Revisions for changing from Network Configurator version 1.32 to 1.5□.
03	September 2006	Revised to include the Network Configurator upgrade from version 1.5□ to 1.6□.
04	June 2007	Revised to include the Network Configurator upgrade from version 1.6□ to 2.00.
05	December 2007	Revised to include the Network Configurator upgrade from version 2.00 to 2.01.
06	March 2008	Revised to include the Network Configurator upgrade from version 2.01 to 2.1□.
07	July 2009	Revised to include the Network Configurator upgrade from version 2.1□ to 2.2□.
08	May 2011	Revised to include the Network Configurator upgrade from version 2.2□ to 3.3□.
09	February 2017	Revised to include the Network Configurator upgrade from version 3.34 to 3.40.
10	October 2022	Revisions for adding safety precautions regarding security.

OMRON Corporation Industrial Automation Company

Kyoto, JAPAN

Contact : www.ia.omron.com

Regional Headquarters

OMRON EUROPE B.V.

Wegalaan 67-69, 2132 JD Hoofddorp
The Netherlands
Tel: (31) 2356-81-300 Fax: (31) 2356-81-388

OMRON ELECTRONICS LLC

2895 Greenspoint Parkway, Suite 200
Hoffman Estates, IL 60169 U.S.A.
Tel: (1) 847-843-7900 Fax: (1) 847-843-7787

OMRON ASIA PACIFIC PTE. LTD.

438B Alexandra Road, #08-01/02 Alexandra
Technopark, Singapore 119968
Tel: (65) 6835-3011 Fax: (65) 6835-2711

OMRON (CHINA) CO., LTD.

Room 2211, Bank of China Tower,
200 Yin Cheng Zhong Road,
PuDong New Area, Shanghai, 200120, China
Tel: (86) 21-5037-2222 Fax: (86) 21-5037-2200

Authorized Distributor:

©OMRON Corporation 2005-2022 All Rights Reserved.
In the interest of product improvement,
specifications are subject to change without notice.

Cat. No. Z905-E1-10 1022